

THE
OLDSMOBILE
SIX

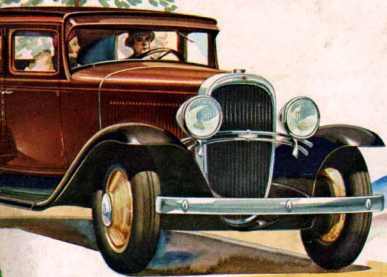



New grace and beauty have been added to Oldsmobile's distinctive appearance

OLDSMOBILE'S ALL-ROUND DESIRABILITY IS THE RESULT OF BALANCED DESIGN

It is a relatively simple engineering task to design a car that emphasizes a few qualities at the sacrifice of others. It is an engineering achievement, however, to combine all desirable qualities in a balanced whole. Yet that is exactly what Oldsmobile engineers have accomplished in Oldsmobile. How well they have succeeded is evidenced by the consistent gains Oldsmobile has made in public acceptance—and by the enthusiasm of owners everywhere.

Every phase of Oldsmobile's performance has been developed to a high degree. Its smart, well-conceived appearance pays tribute to the skill of Fisher artist-engineers. Its ease of handling results from balanced engineering and careful attention to mechanical details. And, as the months and miles roll by, Oldsmobile's balanced design delivers not only these advantages . . . but adds to them the satisfaction of dependability, economy of operation, and long life.

MORE AND MORE . . .
THE TOPIC
OF CONVERSATION

■ THE most valued asset Oldsmobile possesses is the good will of its owners.

And so active is this good will that no matter where you go you find Oldsmobile becoming, more and more, the topic of conversation when the subject turns to motor cars. Owners praise it. Motorists tell of its remarkable performance on the road. Business people talk of its consistent gains in public preference. And the reasons for this growing enthusiasm are evident on examination and trial of the car itself.

2) The 1931 Oldsmobile offers important new features in body, engine, and chassis . . . and new lower prices . . . which add still



further to value and desirability. Advancements include sturdier, more beautiful Fisher bodies, with new body insulation . . . smarter, more comfortable body interiors . . . a substantial increase in horsepower . . . new down-draft carburetion . . . new carburetor-silencer . . . the Synco-Mesh transmission with quiet second gear . . . and a deeper, sturdier frame. Improvements are readily apparent in more distinctive appearance . . . finer all-round performance . . . quieter operation and greater ease of control. In appearance, Oldsmobile



combines the smartness and good taste so much desired by motorists today. New grace and beauty have been added. Body lines are long and low, giving an impression of unusual fleetness. Interiors are characterized by luxury, both in finish and appointments. And new features of design, such as the distinctive

new radiator . . . new chrome-plated head lamps . . . and new streamline seamless fenders, give the new Oldsmobile a definite individuality—a character all its own.

Performance, in turn, is entirely in keeping with the car's smart, distinctive appearance. New down-draft carburetion brings greater power, with increased speed and faster acceleration. Oldsmobile's eager response to every demand . . . whether it's a matter of passing another car on the road . . . flashing away from traffic in the city . . . or conquering hills and hard going . . . is an important factor in the lasting satisfaction of Oldsmobile ownership.

You will discover, too, that no matter how fast you drive the new Oldsmobile, it is always remarkably *smooth*. The new down-draft carburetion together with a newly designed harmonic balancer and a fully counter-weighted and counter-balanced crankshaft assure such smoothness of operation that high speed is made doubly enjoyable. And there are additional features which contribute to more pleasing performance. For example, the throttle is automatically opened to the proper starting position as soon as you step on the starter. And a new carburetor-silencer assures quiet engine operation at all driving speeds.

And important, too, is the fact that no matter where or how far

you drive, Oldsmobile is always restful to ride in. Its roomy Fisher bodies—insulated against heat and cold . . . and its four Lovejoy hydraulic shock absorbers assure genuine comfort on any road. Uncanny roadability—the result of completely *balanced* chassis design . . . contributes to driving security and ease of control. You will particularly appreciate this important safety factor when driving around turns or over graveled roads at a faster than ordinary pace.

The greater comfort of Oldsmobile's new Fisher bodies is supplemented by additional serviceability. Fundamental advancements in Fisher construction, such as the scientific bracing of all points subject to stresses or strains, add to strength and serviceability and make the new bodies remarkably quiet under all operating conditions.

And a new method of anchoring body to chassis gives greater strength and solidity to the car as a whole.

In addition to these essential factors of appearance, performance, and comfort, Oldsmobile provides ease of control which appeals as strongly to men as to women.

The new Syncro-Mesh transmission permits smooth, rapid shifting through all gears . . . from low into second, from second to high, and from *high back to second*—at any speed and in absolute silence. Gear clashing is eliminated. And driving in traffic is easier, for the downward shift—from high into second—can be made without reducing car speed. Further, Oldsmobile has added to the



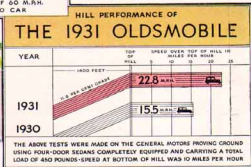
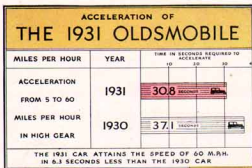

Synco-Mesh transmission a new *quiet* second gear—giving a brand new kind of acceleration. It is unusually swift, to assure a quick lead in traffic. It is remarkably smooth, to give added zest to fast get-away—actually rivaling high gear performance in quietness. Other operating controls . . . such as clutch, steering, and brakes . . . operate with unusual ease and smoothness.

The foregoing advantages—plus one more which experienced motorists count as all important—are sound reasons why Oldsmobile's fame as a fine car continues to spread throughout the country. That final advantage is thorough dependability.

For Oldsmobile, by its consistent month-after-month and year-after-year performance in the hands of enthusiastic owners, has

The sincere desire of Olds Motor Works to give every owner not only a good, dependable car, but lasting satisfaction with its performance, led Oldsmobile, nearly three years ago, to establish a service policy based on fairness and friendliness to the owner . . . a policy that is explicit in its terms and as broad in its application as any in the entire automobile industry. For example . . . in the replacement of defective parts, Olds Motor Works not only assumes the cost of the part but also pays the labor cost of installing it



proved itself a car that can be depended upon in all ways . . . at all times. Prove these things to your satisfaction by talking to Oldsmobile owners. Then take the wheel and drive the car. Submit it to all the tests by which you judge performance, stamina, and all-round ability. Finally, compare the car, feature for feature, with other automobiles at or near its low price.

The more rigid you make your tests and comparisons, the more you will be convinced that Oldsmobile justly deserves its nationwide reputation for value. And knowing its value you will agree with the thousands who say of Oldsmobile—"It's a great car to drive and to own . . . because it gives so much, yet it costs so little."



■ You can purchase your new Oldsmobile on the easy GMAC plan of deferred payments and buy your car from regular monthly income. GMAC financing rates are unusually low. Ask your Oldsmobile dealer for details.



Ask your Oldsmobile dealer for a copy of the book: "Details of Construction," which pictures and describes, in detail, the features of Oldsmobile's progressive and balanced design. In "Details of Construction" you will find interesting descriptions of the advantages of Oldsmobile's many features . . . written in a manner to be readily understood by the non-technical layman. The advantages of Oldsmobile's many modern features in body, engine, and chassis . . . such as . . . body insulation, pressure lubrication to piston pins through rifle-drilled connecting rods, automatic manifold heat control, rear axle rubber insulated from chassis . . . and many others equally important . . . are fully revealed

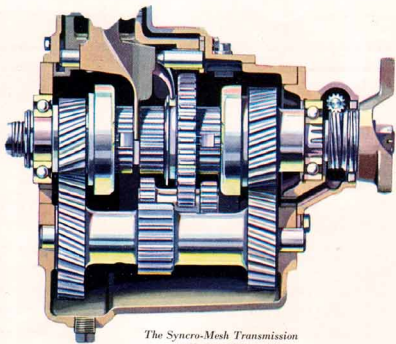

*The Syncro-Mesh Transmission
... with Quiet Second Gear*

■ **D**RIVING the new Oldsmobile is unusually easy and enjoyable because of the famous Syncro-Mesh transmission—a feature heretofore found only in higher priced cars. With the Syncro-Mesh transmission, gear clashing is eliminated. Gear shifting is reduced to an easy, uninterrupted movement of the gear shift lever. Driving through traffic is easier because the shift from high into second—so difficult with the ordinary transmission—can be made smoothly and silently when a burst of speed is desired.

And a new quiet second gear, added to Oldsmobile's Syncro-Mesh transmission, not only gives remarkably swift acceleration, but it also assures quietness which rivals that of high gear performance.

The new Oldsmobile's Syncro-Mesh transmission has three forward speeds and reverse. Control is "standard," as with the ordinary transmission, and the clutch is handled in the usual manner so that the driver feels perfectly at home, even when operating this improved type of transmission for the first time.

■ **O**NE of the chief reasons for the power, smoothness, and efficiency of Oldsmobile's high compression engine is its new down-draft carburetion. This system of fuel distribution permits the air stream from the carburetor to pass *downward* to the cylinders rather than upward. As a consequence, gasoline is forced down rather than lifted by the air stream . . . and a much larger volume of explosive mixture is easily accommodated by the manifold.

The advantages which result from Oldsmobile's down-draft carburetion are fivefold: faster acceleration, higher speed, increased power, greater smoothness, and quicker starting, even in coldest winter weather.

The new combination air-cleaner and carburetor-silencer cleans the air before it enters the carburetor and at the same time quiets the sound of the air stream at the carburetor intake. This new feature not only adds to long engine life by keeping dirt and grit from reaching moving parts but it also increases the pleasure of driving by contributing to quieter performance.

Down-draft Carburetion, Carburetor-Silencer, and Air-Cleaner

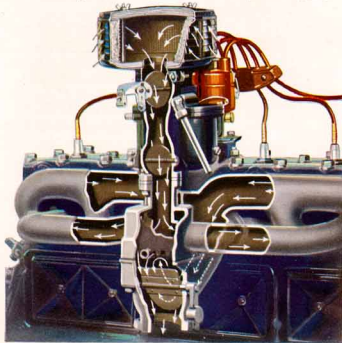

FOUR YEARS OF OLDSMOBILE PROGRESS!

"CHANGES ALWAYS FOR THE SAKE OF PROGRESS . . . NEVER FOR THE SAKE OF CHANGE ALONE"



■ **T**his chart illustrates, at a glance, how Oldsmobile has been refined and improved over a four-year period . . . *without departure from the tried and proved fundamentals of design* which have won the praise of nearly a quarter of a million owners in the past three years. This constant improvement is one reason for Oldsmobile's remarkable dependability. It is also an important factor in the steadily increasing dollar value which Oldsmobile offers . . . year after year.

• • •

The features listed in this chart are not intended to represent anything like a complete list of Oldsmobile's fine car features. There are many others . . . such as the following . . . which contribute to the car's all-round goodness and desirability: silent timing chain . . . pre-engaging starting gear . . . rubber engine mountings . . . double-ribbed, monoblock crankcase . . . stabilized front axle . . . distinctive interior appointments . . . deep, restful seat cushions . . . generous head room and leg room . . . electric gasoline gauge . . . temperature indicator on dash . . . two synchronized tone horns . . . and Fisher VV windshield.

	1931	1930	1929	1928
High Compression Engine—Greater Horsepower.....	65 H.P.	62 H.P.	62 H.P.	55 H.P.
Down-draft Carburetion.....	YES			
Carburetor Silencer.....	YES			
Automatic Manifold Heat Control.....	YES			
Harmonic Balancer on Crankshaft.....	YES			
Synco-Mesh Transmission.....	YES			
Quiet Second Gear.....	YES			
New . . . deeper and stronger . . . Chassis Frame.....	YES			
New . . . more beautiful . . . Body Lines.....	YES			
One-piece, Seamless Fenders.....	YES			
Safety-type Running Boards.....	YES			
Chrome-plated Head Lamps—all models.....	YES			
Quieter . . . steel braced . . . Fisher Composite Bodies.....	YES			
Upholstery Option—Mohair or Whipcord.....	YES			
Foot-controlled Headlight Dimmer.....	YES			
Fully Insulated Bodies.....	FULL	SEMI		
Fully Enclosed Brakes.....	YES	YES		
Roller-bearing, Worm-type Steering.....	YES	YES		
Non-glare Windshield.....	YES	YES		
Counter-weighted Crankshaft.....	YES	YES	YES	
Piston Pins Pressure Lubricated.....	YES	YES	YES	
Spring Cushioned Clutch.....	YES	YES	YES	
Front Seat Adjustable.....	YES	YES	YES	
Radiator Shutters.....	YES	YES	YES	YES
Crankcase Ventilation.....	YES	YES	YES	YES
Oil Filter—Air Cleaner—Gasoline Filter.....	YES	YES	YES	YES
Engine-driven Fuel Pump.....	YES	YES	YES	YES
Four Lovejoy Hydraulic Shock Absorbers.....	YES	YES	YES	YES
Self-adjusting Spring Shackles.....	YES	YES	YES	YES
Tilting Beam Head Lamps.....	YES	YES	YES	YES
Adjustable Steering Wheel Position.....	YES	YES	YES	YES

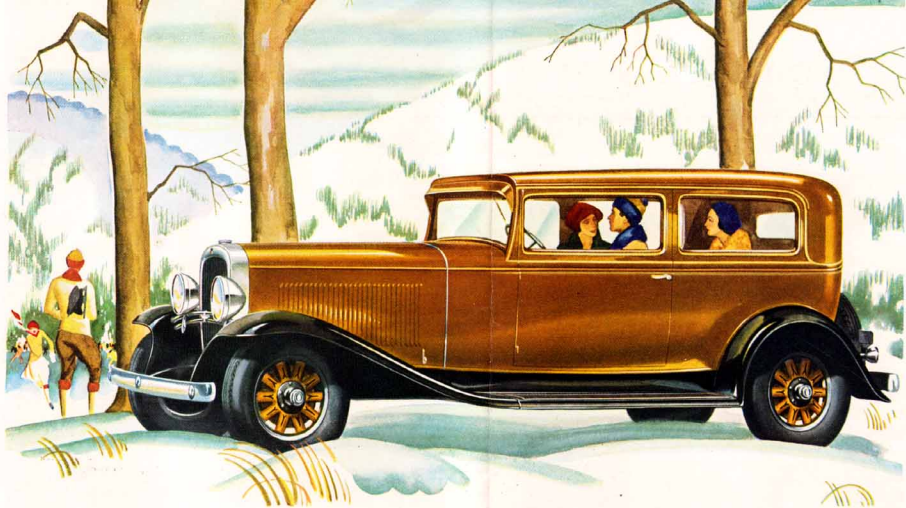

TWO-DOOR SEDAN

■ **OLDSMOBILE'S** smart, well-conceived appearance is a source of lasting satisfaction to owners. Its graceful contours and long, low body lines create an impression of strength and fleetness . . . an impression immediately verified upon detailed examination of the car. The hood is long and high, the body low and generously proportioned. Full-crown, one-piece fenders and small, sturdy wheels add to the pleasing general effect. Viewed from the front, Oldsmobile's

chrome-plated head lamps . . . its smart radiator design . . . and its full-length vertical radiator shutters . . . give a striking and distinctive "head-on" appearance. In keeping with this exterior beauty, Oldsmobile's body interiors are luxuriously finished. Soft, rich upholstery materials, optional in mohair or whipcord . . . attractive hardware of special design . . . and a smartly designed and fully appointed instrument panel combine to give a most pleasing effect.



FOUR-DOOR SEDAN

8 **O**FTEN referred to as the ideal family car, Oldsmobile provides features of driving ease and convenience that make it adaptable to use by any member of the family. There is Oldsmobile's adjustable driver's seat, for example, which is quickly adjustable to the most comfortable driving position . . . and the adjustable steering wheel that goes with it. Clutch, accelerator, and brake pedals, brought within easy reach, are comfortable to operate, both

because their action is easy and because they are faced with cushions of rubber, assuring a firm "grip." Gear changing is accomplished quickly and quietly through the Syncro-Mesh non-clashing transmission. And while gears are being shifted full control of the car is easily maintained. For Oldsmobile answers the lightest touch on the steering wheel . . . and yet there is a feeling of security about Oldsmobile's wheel that results in absolute confidence.



SPORT COUPE

■ **B**ECAUSE traffic conditions today, both in the city and on the road, place a premium on driving ease, Oldsmobile's unusual control features command great interest. The Syncro-Mesh transmission permits easy shifting through all gears without clashing . . . and the new quiet second gear assures smooth, swift acceleration which rivals high gear performance in quietness. The steering gear, of worm-and-roller design, makes parking easy . . . even in

small spaces. Oldsmobile's famous 65-horsepower engine, with down-draft carburetion, carburetor-silencer, and automatic heat control, assures a smooth, quiet flow of power for nimble threading of traffic or effortless hill climbing. In addition, Oldsmobile's speed is quickly and easily controlled by positive-acting four-wheel brakes of the internal-expanding, two-shoe type, completely enclosed and sealed against both dirt and water for most efficient operation.



BUSINESS COUPE

10) ■ OPERATION that is not only smooth but *silent*, month after month and mile after mile, is one of the most desirable features a car can offer. Pains-taking care in the designing and building of engine, chassis, and body has made quietness of operation over a long period an outstanding advantage of Oldsmobile ownership. Down-draft carburetion, a counter-weighted crankshaft with harmonic balancer, a progressive pressure-rise cylinder head, and a

patented carburetor-silencer contribute to the unusual quietness and smoothness of Oldsmobile's engine. Pressure lubrication throughout the engine . . . even to piston pins . . . adds to durability and quietness. Chassis and body are insulated by special anti-squeak material. And Oldsmobile's Fisher bodies, in addition to being built of steel and wood for greatest strength and silence, are also rendered squeak and rattle-proof by an improved method of insulation.

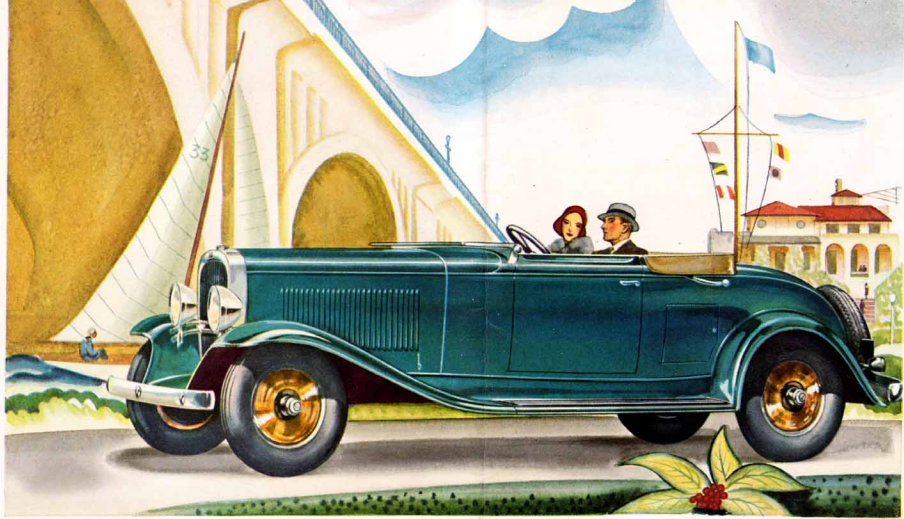

CONVERTIBLE ROADSTER

■ ONE of Oldsmobile's most notable characteristics is the feeling of unusual security which the driver enjoys. Remarkable strength is inherent in both chassis and body. The rugged side rails of the frame have been made stronger and deeper and are braced with five strong cross-members. And the low-dropped frame permits a low center of gravity. This, combined with balanced weight, assures excellent roadability. The single-piece, all-steel con-

struction of the rubber-surfaced running boards is an added safety factor. Internal-expanding, self-energizing four-wheel brakes provide remarkable stopping power under all conditions . . . for they are completely sealed against dirt and water. Fundamental advancements in Oldsmobile's Fisher body construction add to strength and durability. In addition, the VV (vision-ventilating) non-glare windshield prevents annoying light reflections.

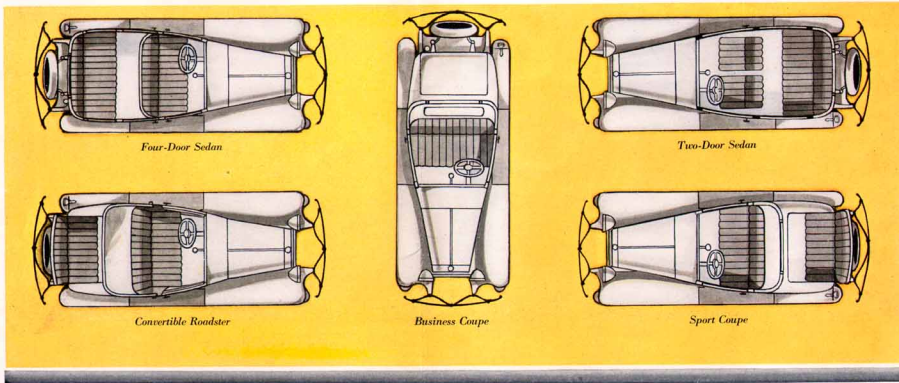

■ EACH Oldsmobile model is carefully planned for the comfort of all passengers. All models have adjustable front seat or adjustable driver's seat . . . bright finish hardware of distinctive design . . . rear view mirror . . . and automatic windshield wiper. Every model, except the Convertible Roadster, is equipped with the Fisher VV (vision-ventilating) non-glare windshield and with curtains at the rear windows. Mohair or whipcord upholstery is optional in all models except the Convertible Roadster. In addition . . . THE TWO-DOOR SEDAN has front seats which tilt forward for easy entrance to the rear seat. Appointments include dome light and foot rail . . . THE FOUR-DOOR SEDAN has a smoking set, dome light, and foot rail . . . THE PATRICIAN SEDAN has luxurious appointments, which include Pullman-type quarter lamps, comfortable arm rests, a silken robe rail, assist cords, smoking

set, mahogany finish garnish moldings, and foot rail. Sides are upholstered to match seat cushions and backs. . . . THE BUSINESS COUPE has a convenient parcel shelf at the rear of the driver's seat, a dome light, and large luggage space in the rear deck. The rear window lowers. . . . THE SPORT COUPE has a comfortable, upholstered drop seat and smoking set. The rear window lowers for free communication between passengers. A convenient locker door at the side opens into a spacious compartment for parcels or golf clubs. . . . THE CONVERTIBLE ROADSTER has a heavy fabric top, with covered wood bows. Window and windshield frames and landau bars are chrome plated. Front seats are of genuine leather, or may be had with whipcord at no extra cost. The drop seat is upholstered in heavy grained material. The windshield folds forward over the cowl. A cowl ventilator provides ample air circulation.



LEFT—*De Luxe Convertible Roadster with top up.* RIGHT—*Standard Convertible Roadster with top down*

BODY STYLES AND EQUIPMENT COMBINATIONS

■ OLDSMOBILE offers a choice of twenty-four different models, each varying from the others in equipment. And six *distinct* body styles are available on the Oldsmobile chassis . . . Two-Door Sedan, Four-Door Sedan, Patrician Sedan, Business Coupe, Sport Coupe, and Convertible Roadster. In addition, four equipment combinations are available on all six body styles.

Standard equipment includes a choice, without additional charge, of five wire wheels or five demountable wood wheels, with special mounting for fifth wheel at the rear, and chromium-plated head lamps. Either mohair or whipcord upholstery is optional in all closed body types. The Patrician Sedan has, in addition, Pull-

man-type quarter lights, a silken robe rail, assist cords, mahogany finish garnish moldings, and a smoking set.

De Luxe equipment includes, at slight additional cost, a choice of six wire or six demountable wood wheels; six tires and tubes; wide, single-bar chromium-plated bumpers, front and rear; and trunk platform. The two spare wheels and tires are securely mounted in fender wells and protected by a special locking device.

Whether you want a car for sport, business, or family use, you will find in Oldsmobile a body type equipped to exactly suit your needs and to satisfy your taste. Your Oldsmobile dealer will be glad to provide you with complete details and prices.

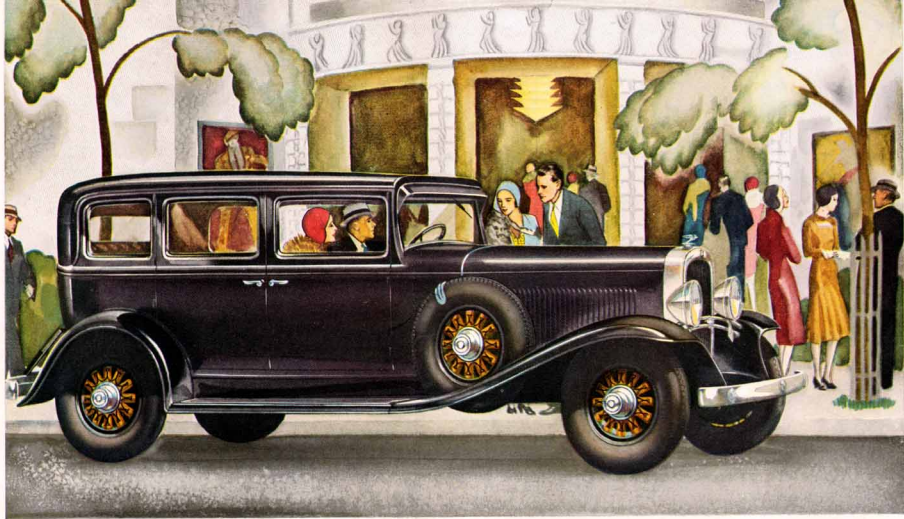

PATRICIAN SEDAN

14 **■** COMPLETE travel luxury, maximum utility, and distinctive interior refinements make this De Luxe Patrician Sedan a car of unusual appeal. Luxurious mohair or whipcord upholstery and hardware of distinctive design create a pleasing effect for the interior. Comfortable arm rests, Pullman-type quarter lamps, and assist cords are provided for rear seat passengers. And unusually wide doors allow easy entrance. The Patrician Sedan is obtainable

with standard equipment or any of the extra equipment combinations defined on the foregoing page. Here is a car that gives comfort, convenience, and smartness in most generous measure. It is a type for all-round use . . . for the individual or family. Careful examination of its many refinements . . . and consideration of all that it offers at the price . . . will convince you that it represents a high standard of luxury and high dollar-for-dollar value.

A SOUND INVESTMENT IN MOTORING SATISFACTION

■ No better description could be applied to Oldsmobile than . . . "A Sound Investment in Motoring Satisfaction." For Oldsmobile represents a sound investment from every angle . . . in price . . . in value . . . and in the deep-seated satisfaction it will afford you as long as you drive it. Owner experience has proved that, given a reasonable amount of care, Oldsmobile will provide gratifying performance over an unusually long period of time. Month after month . . . mile after mile . . . it brings to its owners continued care-free operation which is noticeably free from the pet-

ty annoyances . . . the small but oft-recurring ills . . . which make the difference between partial and complete owner satisfaction. Oldsmobile's nation-wide reputation for dependability has been earned on the basis of merit. Its characteristics of style are pleasing because they are based on the fundamentals of good design. That Oldsmobile should represent an excellent investment on all these scores is not surprising or difficult to understand. For Oldsmobile is a product of the combined rich experience and vast resources of Olds Motor Works, General Motors, and Fisher Body.

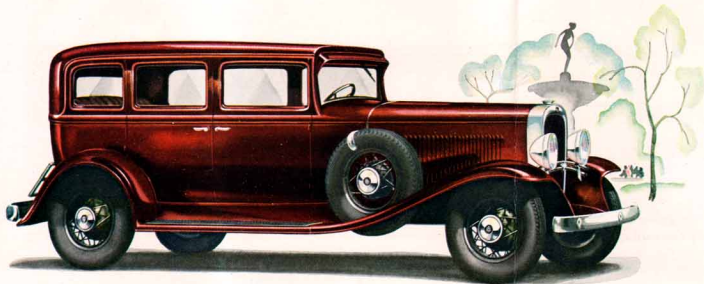

THE DE LUXE FOUR-DOOR SEDAN

■ UNCOMMON roominess and luxuriously upholstered seat cushions make the Five-Passenger Sedan as comfortable as it is smart. Generous seat width enables five adult passengers to ride without crowding. Plate glass windows of large dimensions afford excellent visibility. The Fisher VV windshield is tilted to eliminate annoying reflections.

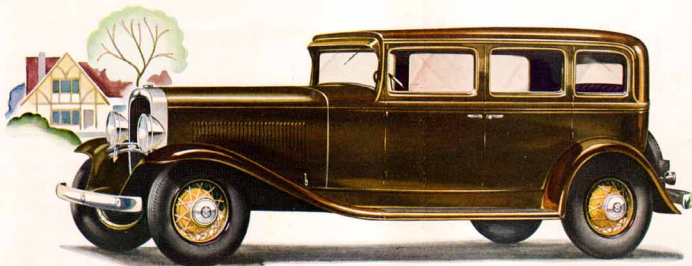

THE FOUR-DOOR SEDAN

With Five Wire Wheels

■ THE Four-Door Sedan is a fine example of the well-balanced appearance so much sought after in closed car design. Its sturdy Fisher body incorporates features which assure unusual quietness and serviceability. A convenient control, located above the VV windshield, permits it to be raised or lowered for direct or indirect ventilation.

THE DE LUXE TWO-DOOR SEDAN

■ THE Oldsmobile Five-Passenger Two-Door Sedan expresses with unusual success the modern vogue for well-planned simplicity. Its smartness is matched by its convenience and comfort. The right front seat, of special chair-type design, tilts forward to the instrument panel . . . while the driver's seat, of the same design, is adjustable.

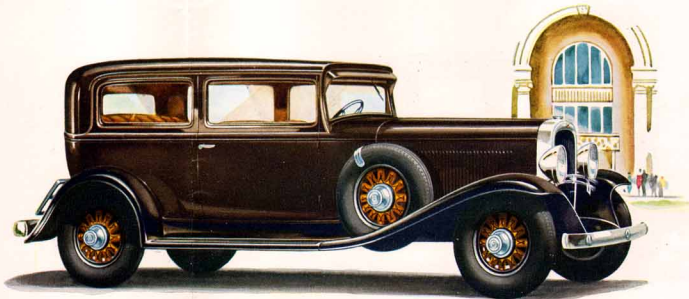

OLDSMOBILE'S BODIES HAVE UNUSUAL QUALITY FEATURES

■ **O**LDSMOBILE'S smart, well-proportioned Fisher bodies, developed as a unit with the Oldsmobile chassis, incorporate many new and unusual features which contribute to satisfactory all-round performance. The sturdy framework is built upon a foundation of all-oak sills. And wherever possible, pressed steel reinforcements are used in place of glue-and-screw fastened joints.

Another feature is the elimination of end joints between wood pieces at all points where squeaks and rattles commonly occur. Anti-squeak material is employed liberally at all body joints.

In addition, Oldsmobile's Fisher body has a one-piece steel

floor, extending from the back of the front seat to the extreme rear of the car . . . for strength and quietness. Also, special precaution has been taken to insulate the driver's compartment in the interests of greater comfort. The dash is insulated against heat and cold by a one-half-inch thick, hair-felt mat . . . covered with heavy grained material. A new type of rubber floor board mat is also provided, together with improved rubber closures for all openings around the steering column, pedals, and other driving controls. Quiet operation is further assured by a new method of anchoring body to chassis . . . and complete *rubber* insulation between body and chassis.

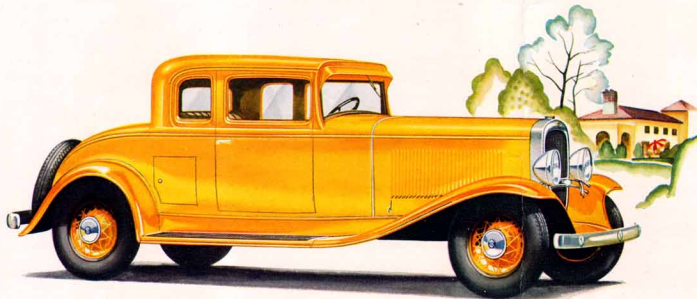

THE SPORT COUPE

With Five Wire Wheels

■ **A**LERT and spirited in appearance as in performance, the Sport Coupe has achieved widespread popularity. The rear deck seat is completely and comfortably upholstered. The rear window lowers for free communication among passengers. A convenient locker door at the side opens into a spacious compartment for parcels or golf clubs.

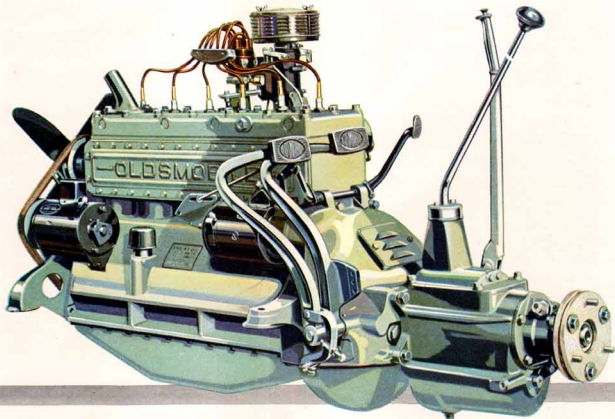

■ **O**LDSMOBILE'S high-compression, six-cylinder engine of the simple, quiet, L-head type has a total piston displacement of 197.5 cubic inches . . . developing 65 horsepower. Unusual efficiency is obtained from down-draft carburetion, which not only adds to power and smoothness but also makes starting in cold weather quicker and easier. The details of engine design are particularly interesting. Large main bearings are supported by heavy, bridge-type trusses which lend great additional strength to the crankcase and serve as a solid bed for the crankshaft. The counter-weighted crankshaft is balanced both statically and dynamically, and is fitted with a harmonic balancer to assure smoothness of operation at all

driving speeds. Both connecting rods and light-weight cast-iron pistons are carefully matched in sets of six . . . assuring perfect balance within each engine. Valves are actuated by a drop-forged, special steel camshaft, mounted in four pressure lubricated bearings. A low velocity rise cam contour promotes quiet valve action and assures long life for valve faces and valve seats. Valve lifters of the simple mushroom type are designed to rotate during their vertical motion . . . a provision which insures durability. A gear-type oil pump, located in the pan and always submerged in oil, provides pressure lubrication for main, connecting rod, and camshaft bearings, and through rifle-drilled connecting rods to the piston pins.

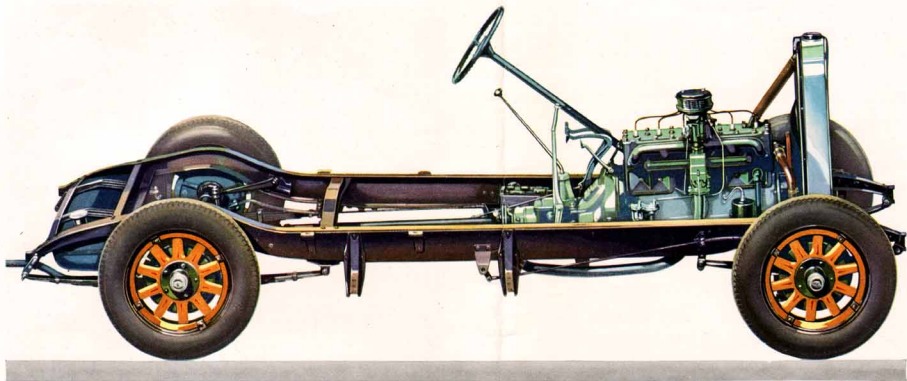

FEATURES THAT ADD TO OWNER SATISFACTION

■ **O**LDSMOBILE's chassis provides features of dependability, safety, handling ease, and riding comfort that contribute in no small measure to owner satisfaction. The sturdy frame is "low swung" to obtain a low center of gravity and resultant roadability. Tapered toward the front, it permits a comfortably short turning radius of 38 feet. This, combined with the steering ease given by Oldsmobile's worm-and-roller steering gear, makes parking easy . . . even in restricted space. The rear axle . . . rubber insulated from the chassis . . . is of heavy-duty, semi-floating design; ring and pin-

ion gears being large in size and carried on annular ball bearings for strength, easy rolling, and silence. The Syncro-Mesh transmission eliminates gear clashing. Smooth, swift acceleration is assured by the new quiet second gear. Smooth, fast deceleration is obtained, with very light pedal pressure, through fully enclosed mechanical four-wheel brakes, of the internal-expanding, self-energizing type. Restful riding ease is assured by long, flexible springs . . . controlled by four Lovejoy hydraulic shock absorbers. In addition, rubber insulation between chassis and body assures quiet operation.

BODY BY FISHER

■ OLDSMOBILE's bodies by Fisher incorporate many values, visible and invisible, responsible for Oldsmobile beauty, comfort, and durability. Fisher body construction combines the advantages of wood and steel . . . a wood frame for greatest strength and resiliency . . . steel forgings and stampings for strongest reinforcement. Both contribute to the remarkable silence, sturdiness, and stamina of Oldsmobile bodies. Another important feature of Fisher construction is the insulation which makes Oldsmobile interiors warm in winter and cool in summer. And still another example of quality is Fisher roof construction. Every roof is a separate assembly of sturdy roof rails, bows, and slats . . . securely bolted to the body framework.

Every point in a Fisher body that may be subject to stresses and strains in service is scientifically braced. Each brace is designed with mathematical accuracy for the stresses it will have to withstand. Another Fisher achievement is the development of smooth, perfectly formed body panels. This perfection is obtained by the use of accurately machined, costly, steel-faced dies.

The gleaming colors of Fisher-built bodies are the result of many processes of spraying, rubbing, and polishing of the lacquer finish used. So well is this work done that Fisher body surfaces remain bright and unbroken through a long period of service. The luxury of Fisher body interiors is the result of careful workmanship and excellent materials. Upholstery combines the utmost in service with smartest appearance. Only high-grade fabrics . . . specially woven for Fisher . . . are used. Seat-cushion and seat-back construction is the result of years of research. It is the most durable and



comfortable type that can be employed. And, in addition, Fisher bodies offer many exclusive features, such as the vision-and-ventilating windshield, Fisher adjustable front seat, and distinctive fittings and appointments. All of these features contribute to the quality of Fisher coach work. "Body by Fisher" is an important reason why Oldsmobile offers unusual value at its moderate price.

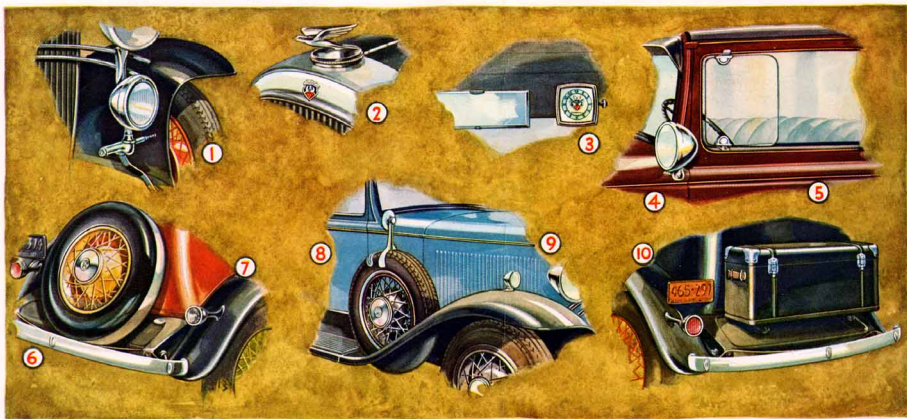

DE LUXE ACCESSORIES DESIGNED FOR OLDSMOBILE

THE De Luxe accessories illustrated above have been especially designed for Oldsmobile cars. All are obtainable from your Oldsmobile dealer at reasonable cost. Accessories shown are . . .
1. Road Lamp (automatic steering arm control type) . . . **2.** Radiator Cap and Ornament . . . **3.** Clock . . . **4.** Adjustable Spotlight . . .
5. Windshield Wings . . . **6.** Metal Tire Cover . . . **7.** Automatic Back-up Light . . . **8.** Tire Mirror . . . **9.** Fender Light . . . **10.** Rear

Platform Trunk. Additional accessories offered by Oldsmobile dealers, but not illustrated here, are . . . Oldsmobile Car Heater . . . Metal Spring Covers . . . Tire Lock . . . and Cigar Lighter.

Bumpers, Spare Tire, and Tire Covers are extra on all standard models

Olds Motor Works reserves the right to make changes in prices and specifications without incurring any obligation to install same on cars already sold



TO DESIGN PROGRESSIVELY



TO BUILD FAITHFULLY



TO SELL HONESTLY



TO SERVICE SINCERELY

22 **OLDSMOBILE** assumes four great responsibilities to every owner . . . to design progressively, to build faithfully, to sell honestly, to service sincerely. Progressive design in Oldsmobile is assured by a capable group of engineers who govern themselves by one inflexible rule . . . "Changes in design shall be made only for the sake of progress—never for the sake of change alone." . . . Good workmanship, in turn, is assured by the unchanging sincerity and good faith

of Oldsmobile workers—an attitude best expressed by the slogan, originated by one of the workers and followed by all . . . "Anything Short of My Best is Not Acceptable." . . . Oldsmobile firmly believes that absolute honesty in selling and in advertising is the only sure road to long-continued public favor. Oldsmobile will not risk public good will by deviating, though it be ever so slightly, from the facts. . . . Finally, Oldsmobile has instituted a service policy which

recognizes . . . in a full measure . . . its service responsibility to owners. Oldsmobile accepts responsibilities which are commonly left to the dealer, because Oldsmobile's interest in every sale goes far beyond the time of purchase. . . . To design progressively . . . to build faithfully . . . to sell honestly . . . to service sincerely . . . four great responsibilities—recognized by Oldsmobile and willingly assumed in order that every Oldsmobile owner shall be, and remain, a friend of Oldsmobile.

■ VISITORS always receive a warm welcome at Olds Motor Works. The entire procedure of Oldsmobile manufacture, from raw materials to finished product, is open to the public without reservation. Olds Motor Works feels positive that accurate public knowledge of the high standards it has established in materials, workmanship, and inspection can only add to public confidence in Oldsmobile.

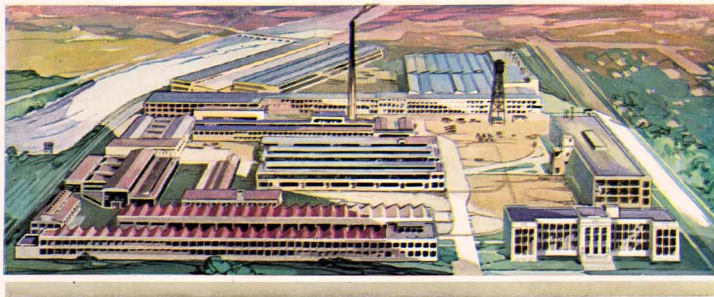

■ OVER the roadways of the General Motors Proving Ground, Oldsmobile engineers are constantly testing and re-testing Oldsmobile cars in the most scientific manner possible. Here, cars can run at high speeds or low and over roads of all types and conditions. Here, ingenious devices, many of them previously unknown to the scientific world, give actual graphic record of motor car performance.

THE OLDSMOBILE SIX



Copyright, 1931, Olds Motor Works, Lansing, Michigan

Form No. 1-31
PRINTED IN U. S. A. BY
EVANS-WINTERS-NEED, DETROIT

