

UNIQUELY DISTINCT

Blend your style with Eclipse Cross and customize yours with meticulously measured accessories. From cargo mats and tonneau covers, to all-weather and entertainment packages, it doesn't take much to enhance its prominent and distinctive design.

At Mitsubishi Motors, we believe not all drivers are created equal. So we build our vehicles for a different breed of driver, the fearless ones who take pride in what they drive, and refuse to drive more of the same. It's obvious to us that people who truly want distinctive styling and the latest technology see past the procession of bland imitations. We believe that every vehicle we make should stand for something. Something more than expected. And that's why we don't build Mitsubishi cars for stereotypes. We build them for you.

MITSUBISHICARS.COM 1-888-MITSU2019 NATLBRO-19-002



ADDITIONAL EQUIPMENT

ALL-WEATHER FLOOR MATS



BRIGHT LOWER DOOR MOLDING



WHEEL LOCKS



CARGO MAT



TOW HITCH



SILVER FRONT GARNISH



ECLIPSE CROSS



2019

AMBITION

It's an attitude true to Mitsubishi since our first car was manufactured a century ago. With 100 years of redefining the driving experience, our heritage has become our foundation as we look to tomorrow.

Like you, we're motivated by ambitious, uncompromising passion, which is exactly how the Eclipse Cross came to be. Feel what it's like to blur the line between stimulating design and confidence-inspired driving. Blend sophistication with attitude. Balance vibrancy with defiance.

We are for the ambitious. The determined go-getters. The ones who seize opportunities that lead to long-lasting experiences. And methodically crafting cars in an unyielding pursuit of excellence is our way of showing it. Because to us, ambition has always been reserved for the driven.

DRIVE YOUR AMBITION



DESIGN

BY DYNAMIC DESIGN

The Eclipse Cross effortlessly combines striking design with advanced technology. Inspired by an athlete crouched in a starting position, its vibrant and defiant styling stands out in any crowd, while its innovative features put the latest tech right at your fingertips. Literally.



As awarded by The Chicago Athenaeum
Museum of Architecture and Design

Eclipse Cross SEL Touring Package in Red Diamond with accessories

DESIGN

LOVE AT FIRST SIGHT

The sharply sculpted character line creates the appearance that the Eclipse Cross was carved from a single block of metal.

IT'S NOT MAGIC; IT'S SCIENCE

Engineered with stimulating design, the Eclipse Cross blurs the line between wedge-shaped coupe styling and the practicality of space and comfort. Equipped with a higher hip point and lower windows for added visibility, it gives purpose to style.

DYNAMIC SHIELD DESIGN

With sharp and muscular front fenders, the Eclipse Cross expresses true sportiness and style. And the advanced Dynamic Shield front-face design makes a statement—on the highway, and in the driveway.

AVAILABLE PANORAMIC GLASS SUNROOF

There's always more to see, inside and out. With Mitsubishi's first dual-pane power sliding panoramic glass sunroof, gazing just took on a whole new meaning.

REAR WEDGE DESIGN

High-mounted stop lights and double rear windows express dynamic rear design characteristics.

PREMIUM METALLIC PAINT

Expressive with a purpose. Our newly developed Red Diamond premium paint produces a vibrantly rich color with higher intensity and brightness.

LED HEADLIGHTS

The distinctive lighting and headlamp design on the Eclipse Cross make it easy to look on the bright side. Its available LED headlights enhance your ability to see potential road hazards or obstructions ahead, and at greater distances. Plus, LED lights draw less power from the battery and are generally more reliable than conventional lights.

LED REAR COMBINATION TAIL LIGHTS

Day or night, defiant rear LED lights display a commanding personality. The unique tail lamp lighting on Eclipse Cross wraps the rear wedge and emphasizes its aggressive stance, while emitting light in a vivid, straight line.



Eclipse Cross SEL Touring Package in Red Diamond with accessories





COMFORT

BEAUTY, INSIDE AND OUT

Eclipse Cross is as stunning from the inside as it is on the outside. Crafted to provide drivers with an intuitive driving experience, it blends luxury with technology and surrounds you in premium comfort and safety.

COMFORT

COMFORT ZONES

Eclipse Cross makes it easy to expand your comfort zone with its thoughtfully designed interior. With careful attention to detail, the dynamically crafted cockpit wraps drivers in premium Gloss Black and luminous silver accents. And bold, colorful stitching complements the available premium leather-appointed seats and leather-wrapped shift knob.

STEERING WHEEL

Drivers will find ample controls on the steering wheel that operate the vehicle's hands-free BluetoothSM voice controls and cruise control features. There's also an available heated steering wheel option and standard tilt/telescoping functionality, making it easier for those who share their Eclipse Cross with other drivers to find that perfect driving position.

HEATED FRONT AND REAR SEATS

With available front and rear heated seats, comfort is no longer exclusive to the front row.

HEATED POWER SIDE-VIEW MIRRORS

Standard heated side-view mirrors help provide peace of mind and clear visibility on those frosty mornings.

FAST-KEY PASSIVE ENTRY SYSTEM WITH PUSH BUTTON START

The FAST-Key passive entry system makes for an easy entry into Eclipse Cross. Unlock the doors by simply pressing the lock/unlock switch on either front door or the liftgate OPEN switch. You can even start or stop the engine with the keys tucked away in a pocket or purse with a press of the push-button ignition.

DUAL-ZONE CLIMATE CONTROL

This available feature gives front-seat occupants customized comfort. The front vents are divided into separate systems with separate temperature controls, so the driver and the front passenger can each adjust the environment on their side of the vehicle to their comfort level.



LOW PROFILE, HIGH RESOLUTION

The available 7-inch HD Smartphone Link Thin-Display Audio system is compatible with Apple CarPlaySM and Android AutoSM. CarPlaySM is the smarter, safer way to use your iPhone[®] to access Apple MusicSM and Maps, send messages, and make calls with Siri[®] or the car's touch screen. Android AutoSM delivers safety and convenience with larger touch targets, a simplified interface, and Google Assistant to minimize distractions so you can stay focused on the road.^{9,10}

CARGO VERSATILITY

No matter who or what you're hauling, the space inside Eclipse Cross makes it easy to balance rear seat room with storage. The 60:40 split rear seat allows for the rear seats to be folded in different configurations to accommodate various shapes and sizes of cargo.

Balancing rear seat legroom and rear cargo room is easy with a rear seat that has the ability to recline in 9 different positions and slide up to 7.8" to accommodate more cargo or to provide more rear seat legroom.



TECHNOLOGY

DRIVE EMPOWERED

Designed specifically to fit your lifestyle, the seemingly limitless features inside and outside of Eclipse Cross leave you feeling like there's nothing it doesn't have.



Eclipse Cross SEL Touring Package in Black Leather



TECHNOLOGY

FULL-COLOR HEAD-UP DISPLAY (HUD)

Keep both hands on the wheel and both eyes on the road. Full-Color Head-Up Display (HUD) rises close to your line of sight, allowing easier driving without compromising safety. It displays helpful vehicle information like miles per hour, cruise control, Forward Collision Mitigation (FCM),² seatbelt reminders and more—allowing fuller visibility and uncompromised safety.

CONTROL, AT YOUR FINGERTIPS

Control more than just the road. Eclipse Cross allows your fingers to do more swiping and tapping with the available Touchpad Controller when connected to your Apple CarPlay™. Effortlessly traverse its intuitive audio display, phone controls and more.

STYLE THAT SPEAKS TO YOU

Bluetooth® wireless technology¹³ lets you play music from your smartphone and USB devices, wirelessly and hands free. Along with buttons on the steering wheel, the system also utilizes available voice recognition technology, so you can operate selected features with voice commands, if available. It recognizes up to seven different mobile phones, syncing up with contact lists from each phone that's been paired with the system and keeping the lists private to each user.

SIRIUSXM® SATELLITE RADIO

On select trims, Enjoy over 150 channels of the best commercial-free music, plus every major sport and the biggest names in entertainment, news and comedy. Listen in your car, on the app and online with a 90-day All Access trial subscription.¹²

ROCKFORD FOSGATE® PREMIUM AUDIO SYSTEM

Eclipse Cross' available Rockford Fosgate® 710-watt audio system powers nine premium speakers, including a 10-inch, dual-voice-coil subwoofer.¹¹ The system incorporates an advanced Digital Signal Processor (DSP) and offers the listener PUNCH® Control over the subwoofer, sound field control over the image and staging of the system, and the latest DTS® Neural Surround.

MITSUBISHI CONNECT

In an increasingly connected world, Mitsubishi strives to set and exceed the standard of innovative technology. Mitsubishi Connect¹⁴, a connected car service that provides a personalized, safer and enriched driving experience.

Mitsubishi Connect packages Safeguard Services and Remote Services into one convenient experience. With innovative services like in-dash apps, support services and smart home features through Amazon Alexa, and Google Home, Mitsubishi Connect subscribers find that every drive is inspired by confidence.



Eclipse Cross SEL Touring Package in Red Diamond with accessories

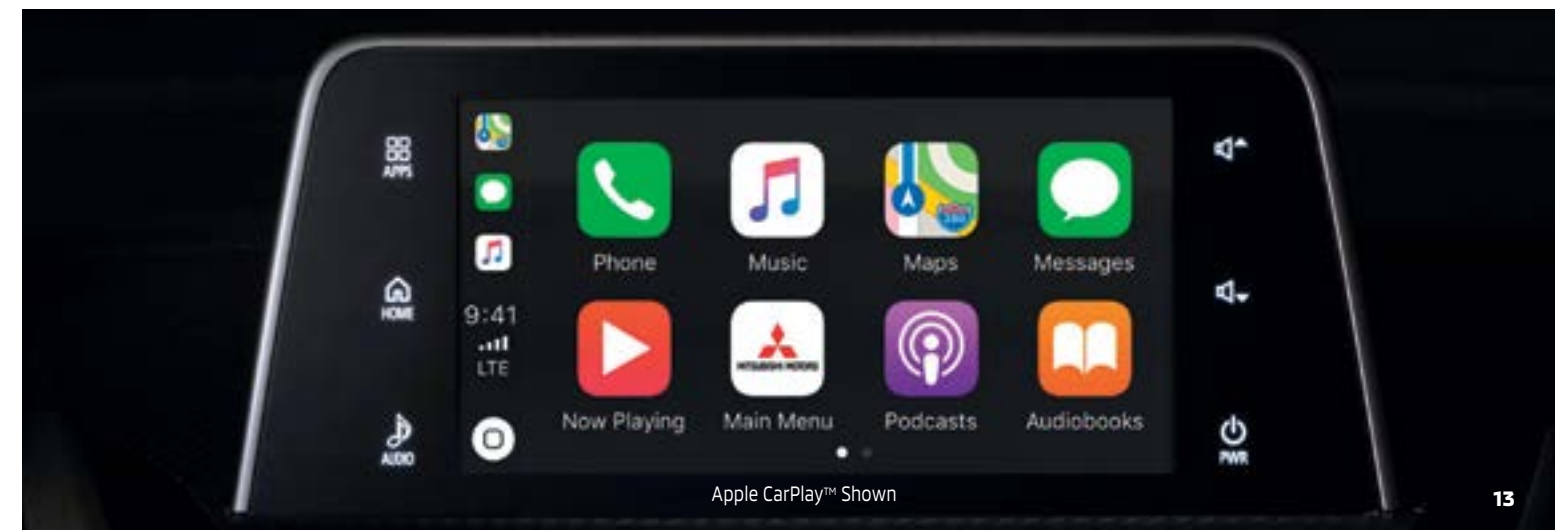

Apple CarPlay™ Shown





PERFORMANCE

JOYRIDE ANY RIDE

Performance and driving confidence have been ingrained in Mitsubishi DNA for 100 years—why let it slip now? The Eclipse Cross is packed with features that include a 1.5L direct-injection turbo engine, an available Super All-Wheel Control system, available 18-inch alloy wheels with low-profile tires, and more. Additionally, the highly rigid body structure and wedge-shaped rear help keep drag and resistance to a minimum.





PERFORMANCE

1.5L DIRECT INJECTION TURBO ENGINE

Turbo technology has been reengineered to focus on low-end torque for improved acceleration at city speeds, while maintaining the efficiency and MPG of a small displacement engine.

In Sport Mode, the available paddle shifters complement the 8-step CVT transmission for a more engaged driving experience.

18" ALLOY WHEELS

The available two-tone 18-inch alloy wheels do more than just look great—they also enhance performance. Their tall profile allows for a shorter tire sidewall, which helps minimize side-to-side tire flex when cornering.

HILL START ASSIST (HSA)

When accelerating from a standstill on a steep incline, Hill Start Assist helps prevent the vehicle from rolling backward. This standard feature, when activated, holds the brakes for approximately two seconds to give you time to move your foot from the brake pedal to the accelerator.

SUPER ALL-WHEEL CONTROL (S-AWC)

Standard on the LE, SE and SEL models, the Super All-Wheel Control (S-AWC) system combines several advanced technologies to give you maximum traction. Active Stability Control (ASC) helps keep your Eclipse Cross on its intended path when cornering and the Anti-lock Braking System (ABS) along with Active Yaw Control (AYC) distributes driving torque to the rear wheels and between right and left wheels by additional brake force. Even choose from different driver-selected modes for optimal 4WD performance in various conditions, while balancing efficiency.

AUTO MODE

Auto Mode achieves 4WD performance in various conditions.

SNOW MODE

Snow mode is ideal for snow, mud and rain or whenever the road surface conditions are extremely slippery.

GRAVEL MODE

Gravel Mode excels on rough road driving and when pulling out of stuck conditions.





SRS
AIRBAG



SAFETY

THERE'S SAFETY IN NUMBERS

There's more to the Eclipse Cross than its vibrant appearance. Beneath the dynamically designed surface lies an abundance of today's enhanced safety tools, should an unforeseen incident arise.

In addition to its seven standard airbags,¹ including one for the driver's knees, Eclipse Cross also offers available Automatic High-Beam headlights, Forward Collision Mitigation² with pedestrian detection capability, Blind Spot Warning³ with Lane Change Assist,⁴ Rear Cross Traffic Alert,⁵ Adaptive Cruise Control⁶ and Lane Departure Warning.⁷

SAFETY

CONTROLLING THE UNCONTROLLABLE

From available Automatic High Beam headlights (AHB), Forward Collision Mitigation (FCM),² Blind Spot Warning (BSW)³ and Lane Change Assist (LCA)⁴ to Rear Cross Traffic Alert (RCTA),⁵ Lane Departure Warning (LDW),⁷ Adaptive Cruise Control (ACC)⁶ and Active Stability Control (ASC), Eclipse Cross puts safety in numbers, allowing you to remain in control when unforeseen circumstances arise.

AUTOMATIC HIGH BEAM HEADLIGHTS (AHB)

Available Automatic High Beam Headlights (AHB) automatically switch to low beam when other vehicles are detected on the road ahead. When the driver assistance camera detects objects in front of the vehicle, it automatically switches operation between high and low beams.

FORWARD COLLISION MITIGATION (FCM)

The available Forward Collision Mitigation (FCM)² system utilizes both radars and camera technology to determine if a frontal collision with a vehicle or pedestrian is imminent. If so, it warns the driver with audible and visual signals, and automatically applies moderate to emergency braking to reduce the severity of the collision and, if possible, avoid the collision.

BLIND SPOT WARNING (BSW) AND LANE CHANGE ASSIST (LCA)

Available Blind Spot Warning (BSW)³ and Lane Change Assist (LCA)⁴ help you safely change lanes by alerting you when a vehicle is in or approaching your blind spot.

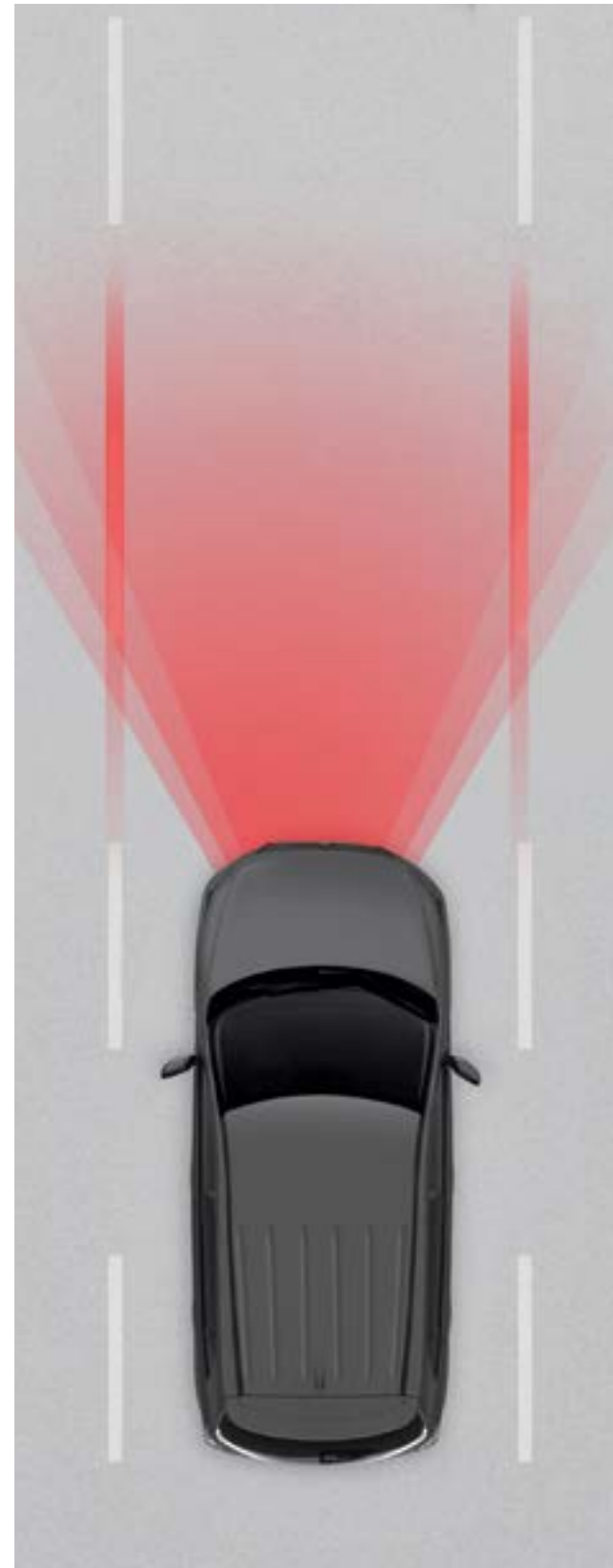



Vehicle shown on screen is Outlander



SAFETY

REAR CROSS TRAFFIC ALERT (RCTA)

Available Rear Cross Traffic Alert (RCTA)⁵ helps you safely back out of a parking space or driveway by alerting you if another vehicle is about to cross your path.

REARVIEW CAMERA

There's a lot to see, and even more to look at. The standard rearview camera provides a measure of assurance by showing what the naked eye doesn't always see. In Eclipse Cross, visibility comes standard.

MULTI-VIEW CAMERA SYSTEM

This available feature displays what's seen by cameras mounted on the front, rear and sides of the vehicle. Views from these multiple angles – including a bird's-eye view – can be shown in various combinations that create a virtual 360° image on Eclipse Cross audio display screen to help you park or back up more safely.⁸

LANE DEPARTURE WARNING (LDW)

The available Lane Departure Warning (LDW) system⁷ uses an onboard camera to monitor lane position ahead. Eclipse Cross will audibly and visually alert the driver if it detects the vehicle leaving its lane unintentionally.

ACTIVE STABILITY CONTROL (ASC)

When the advanced Active Stability Control (ASC) system in the Eclipse Cross detects a loss of traction, braking force is applied at one or more wheels. Plus, engine output is automatically adjusted to help you remain in control.

ADAPTIVE CRUISE CONTROL (ACC)

The available Adaptive Cruise Control (ACC)⁶ uses radar to detect a vehicle ahead and maintain a preset distance between you and that vehicle. If the vehicle ahead speeds up or slows down, the system will adjust your speed accordingly. If the vehicle moves out of the lane, it will return to the speed previously selected.

SEVEN STANDARD AIRBAGS

A standard Supplemental Restraint System (SRS) features seven airbags: dual-stage front airbags with seat position sensors, front side airbags, side curtain airbags and a driver's knee airbag.¹



CONNECTIVITY

MITSUBISHI CONNECT

Mitsubishi Connect¹⁴ provides innovative connected services, while Eclipse Cross Connected Vehicle Service (CVS) and mobile app bring valuable vehicle information to your smartphone.

SAFEGUARD and REMOTE SERVICES

Every Mitsubishi Connect vehicle includes a 2-year trial subscription and third year discount for Safeguard and Remote Services.

Safeguard helps maintain the vehicle 24/7 with:

- Roadside Assistance
- Automatic Collision Notification
- SOS Emergency Assistance
- Information Assistance
- Alarm Notification
- Stolen Vehicle Assistance
- Mileage Tracker

Remote Services helps control your Eclipse Cross remotely through an app on your smartphone. Along with smart homes with Amazon Echo/Google Home, you can do the following:

- Adjust climate settings
- Unlock/lock doors
- Control lights, the horn, and location and vehicle settings
- Control parental settings like geofencing, speed alerts and curfew alerts

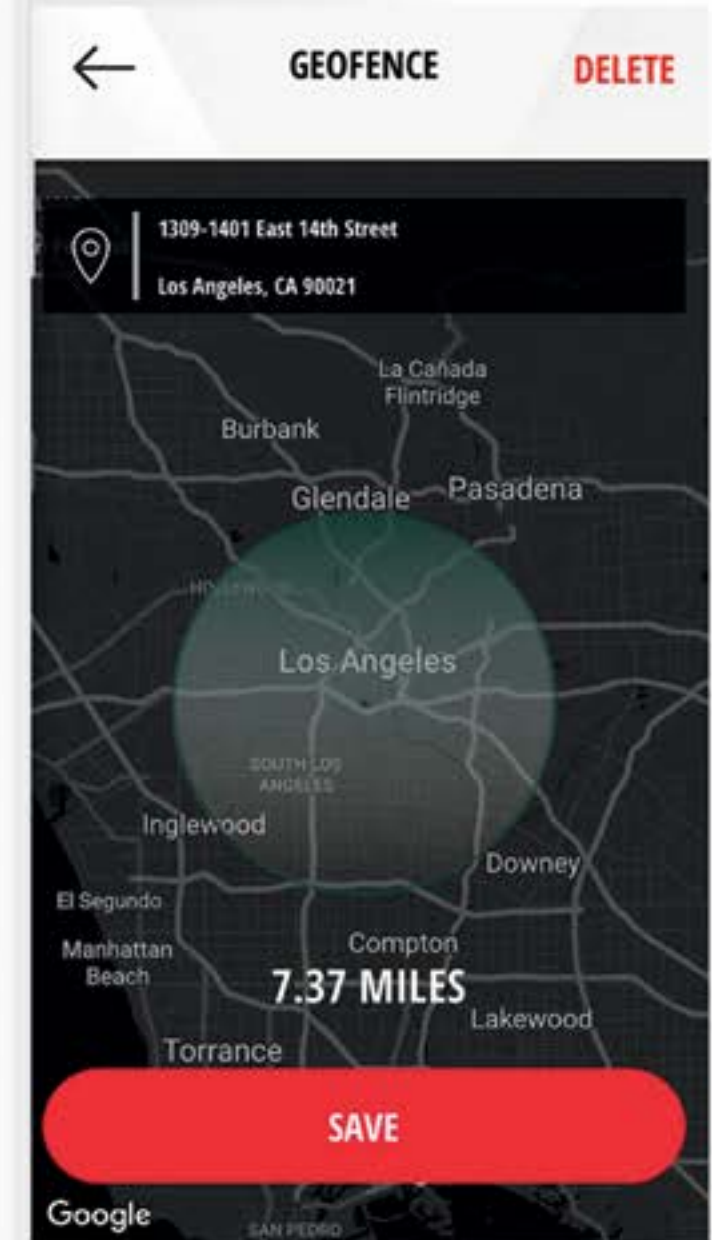
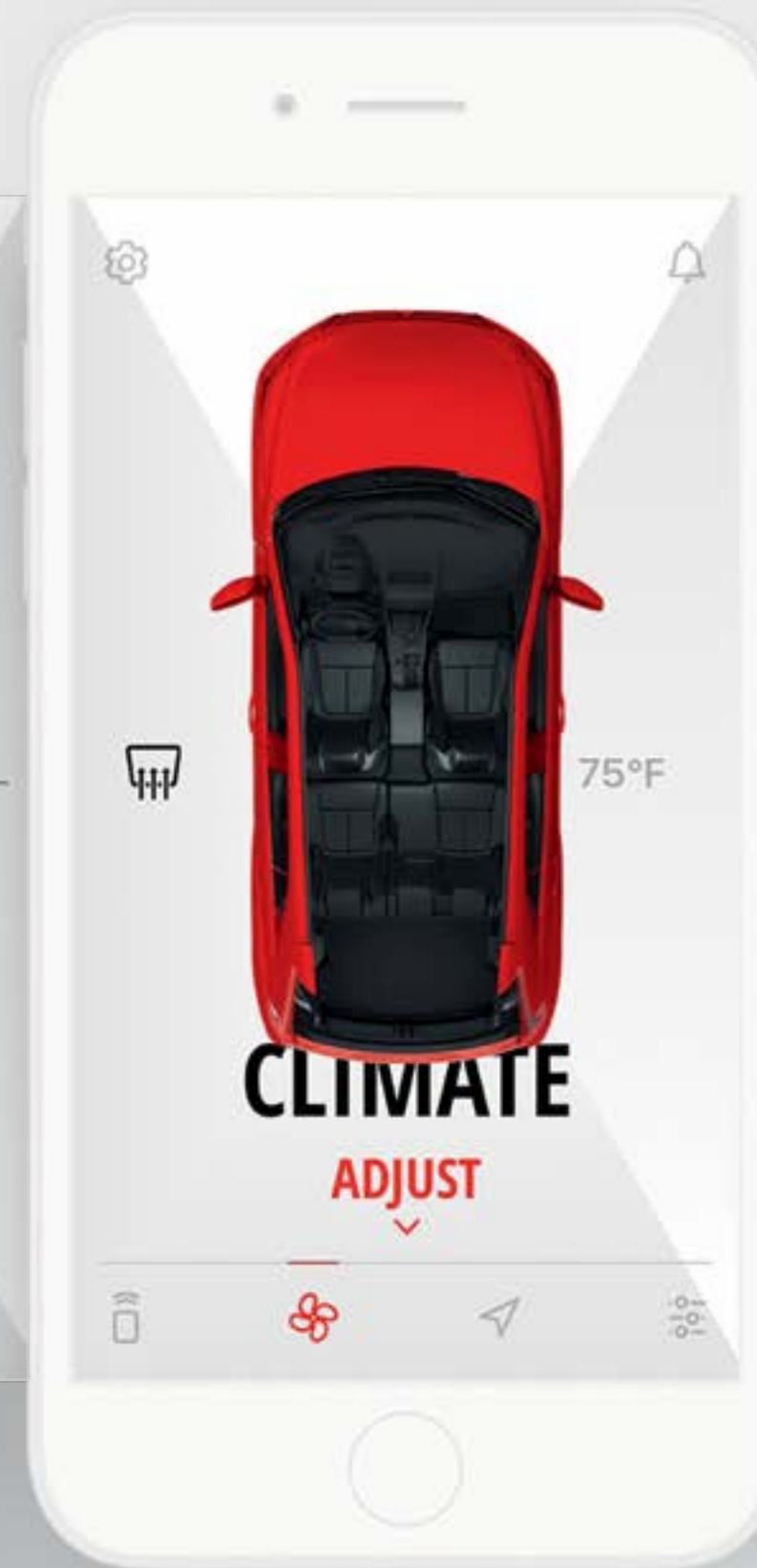
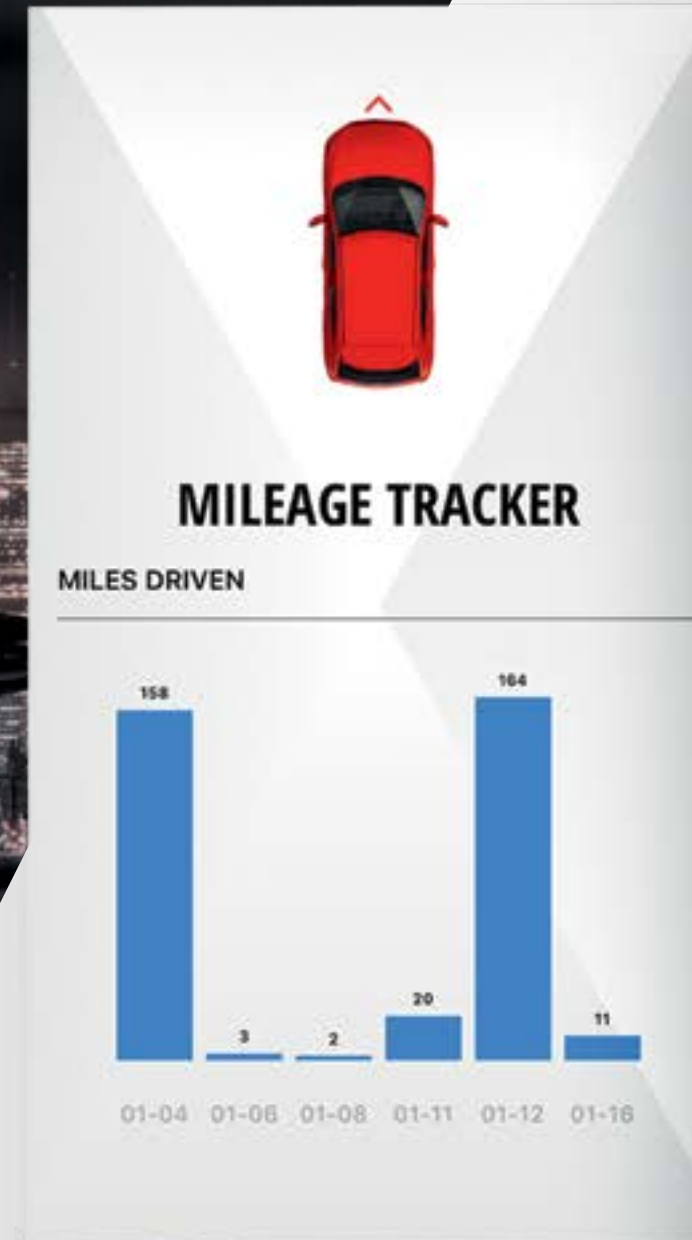

WARRANTY

10-YEAR/100,000 MILE WARRANTY

Mitsubishi has your back with a 10-year/100,000-mile Powertrain Limited Warranty. But it doesn't stop there. Along with a roadside assistance plan that provides support for five full years, and a commitment to innovation that comes from nearly a century of building some of the world's most methodically engineered vehicles, Mitsubishi Confidence is your assurance that your new Eclipse Cross will be there for you today, tomorrow and long into the future.

10-year
100,000-mile
POWERTRAIN LIMITED WARRANTY



SPECIFICATIONS

EXTERIOR COLORS	ES 2WD / ES S-AWC	LE S-AWC	SE S-AWC	SEL S-AWC	EXTERIOR COLORS	ES 2WD / ES S-AWC	LE S-AWC	SE S-AWC	SEL S-AWC
Pearl White	1	1	2/3	4	Octane Blue Metallic	1	1	2/3	4
Alloy Silver Metallic	1	1	2/3	4	Tarmac Black Metallic	1	1	2/3	4
Mercury Gray Metallic	1	1	2/3	4	Red Diamond	1	1	2/3	4
Bronze Metallic	1	1	2/3	4					

The numbers indicate interior colors / trims available with exterior vehicle color.

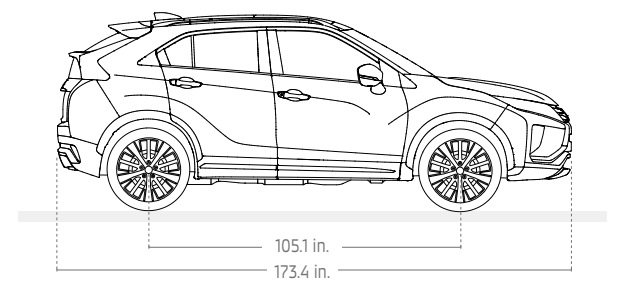

EXTERIOR DIMENSIONS	
Overall length	173.4 in.
Wheelbase	105.1 in.

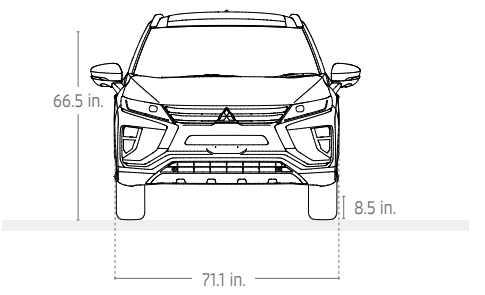

EXTERIOR DIMENSIONS FOR S-AWC MODELS	
Overall height	66.5 in.
Overall width	71.1 in.
Ground clearance	8.5 in. (8.0 in. 2WD)
Track, front	60.6 in. (60.8 in. 2WD)
Track, rear	60.6 in. (60.8 in. 2WD)

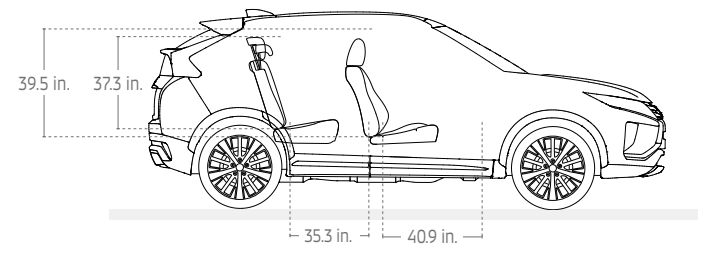

INTERIOR DIMENSIONS	Head Room (with sunroof)	Shoulder Room	Legroom	Hip Room
Front	39.5 in. (39.5 in.)	56.2 in.	40.9 in.	53.0 in.
2nd row	37.3 in. (36.7 in.)	55.1 in.	35.3 in.	52.0 in.

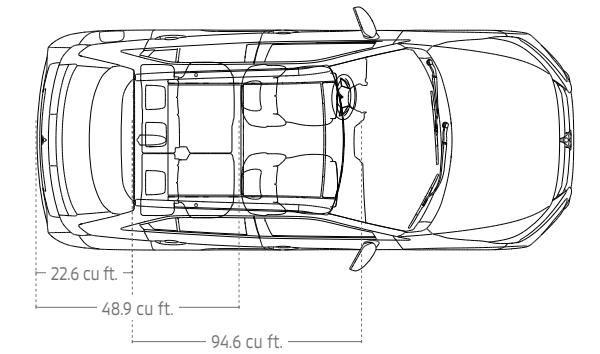

VOLUME	
SAE Passenger volume	94.6 cubic ft. (93.9 cu. ft. with sunroof)
SAE Cargo volume - behind front seats (est.)	48.9 cubic ft. (48.8 cu. ft. with sunroof)
SAE Cargo volume - behind 2nd row seats (est.)	22.6 cubic ft. (22.1 cu. ft. with sunroof)

Illustrations are for design purposes only.

SPECIFICATIONS

FEATURE DESCRIPTION	ES 1.5T 2WD	ES1.5TS-AWC	LE1.5TS-AWC	SE1.5TS-AWC	SEL1.5TS-AWC
MECHANICAL FEATURES					
ENGINE					
1.5L Direct-Injection Turbo Engine	STD	STD	STD	STD	STD
TRANSMISSION/DRIVE SYSTEM					
Continuously Variable Transmission (CVT) with 8-step	STD	STD	STD	STD	STD
Super All-Wheel Control (S-AWC)	-	STD	STD	STD	STD
Front-Wheel Drive (FWD)	STD	-	-	-	-
Paddle shifters	-	-	-	-	STD
SUSPENSION					
MacPherson front strut suspension with stabilizer bar	STD	STD	STD	STD	STD
Multi-link rear suspension with stabilizer bar	STD	STD	STD	STD	STD
STEERING					
Electric power steering	STD	STD	STD	STD	STD
EXTERIOR FEATURES					
LED headlights	-	-	-	-	STD
Halogen headlights	STD	STD	STD	STD	-
Fog lights	STD	STD	STD	STD	STD
LED running lights	STD	STD	STD	STD	STD
Auto on/off headlights	-	-	-	STD	STD
LED rear combination tail lights	STD	STD	STD	STD	STD
LED high mount stop light	STD	STD	STD	STD	STD
Color-keyed front and rear bumpers	STD	STD	STD	STD	STD
Chrome upper grille	-	-	-	STD	STD
Front Bumper Center (material black)	STD	STD	STD	-	-
Front Bumper Center (gloss black)	-	-	-	STD	STD
Silver front and rear bumper with garnish	-	-	-	STD	STD
Color-keyed outside door handles	STD	STD	STD	STD	STD
Chrome side-window molding	STD	STD	STD	STD	STD
Wheel arch moldings	STD	STD	STD	STD	STD
Black lower door trim	STD	STD	STD	-	-
Black lower door trim with silver accent	-	-	-	STD	STD
Color-keyed side-view mirrors with turn indicators	STD	STD	-	STD	STD
Black side-view mirrors with turn indicators	-	-	STD	-	-
Power folding side-view mirrors	-	-	-	STD	STD
Heated power side-view mirrors	STD	STD	STD	STD	STD
Dual pane power panoramic sunroof	-	-	-	-	OPT
Front windshield variable intermittent wipers	STD	STD	STD	-	-
Front windshield rain-sensing wipers	-	-	-	STD	STD
Rear window intermittent wiper/washer with defroster	STD	STD	STD	STD	STD
Rear privacy glass	STD	STD	STD	STD	STD
Roof spoiler	STD	STD	STD	STD	STD
Black roof rails	-	-	-	-	OPT
Shark-fin antenna	STD	STD	STD	STD	STD
ES badge	STD	STD	-	-	-
Limited Edition badge	-	-	STD	-	-
SE badge	-	-	-	STD	-
SEL badge	-	-	-	-	STD
18-inch two-tone alloy wheels	-	-	-	STD	STD
18-inch black alloy wheels	-	-	STD	-	-
16-inch alloy wheels	STD	STD	-	-	-
225/55R18 all-season tires	-	-	STD	STD	STD
215/70R16 all-season tires	STD	STD	-	-	-
Temporary spare tire	STD	STD	STD	STD	STD
INTERIOR FEATURES					
LCD Color multi-information display	STD	STD	STD	STD	STD
High-contrast meters	STD	STD	STD	STD	STD
Dual sun-visor vanity mirrors with illumination	-	-	-	STD	STD
Dual sun-visor vanity mirrors	STD	STD	STD	-	-

FEATURE DESCRIPTION	ES 1.5T 2WD	ES1.5TS-AWC	LE1.5TS-AWC	SE1.5TS-AWC	SEL1.5TS-AWC
INTERIOR FEATURES (CONT.)					
Extendable sun-visors	STD	STD	STD	STD	STD
Front map lights	STD	STD	STD	STD	STD
Rear dome light	STD	STD	STD	STD	STD
Cargo light	STD	STD	STD	STD	STD
8-way power adjustable driver's seat	-	-	-	-	STD
6-way adjustable driver's seat	STD	STD	STD	STD	-
4-way adjustable front passenger seat	STD	STD	STD	STD	STD
Heated front seats	-	-	-	STD	STD
Heated rear seats	-	-	-	-	OPT
Fabric seating surfaces	STD	STD	STD	-	-
High-grade fabric seating with contrast stitching	-	-	-	STD	-
Leather seating surfaces	-	-	-	-	STD
60/40 split fold-down rear seatback	STD	STD	STD	STD	STD
Rear seat slide and recline functions	STD	STD	STD	STD	STD
Rear seat center armrest with cupholders	-	-	-	STD	STD
5 Passenger seating	STD	STD	STD	STD	STD
Driver's seat back pocket	-	-	-	-	STD
Passenger front seat back pocket	STD	STD	STD	STD	STD
Heated steering wheel	-	-	-	-	OPT
Leather-wrapped steering wheel	-	-	-	STD	STD
Urethane steering wheel	STD	STD	STD	-	-
Tilt and telescopic steering wheel	STD	STD	STD	STD	STD
Leather-wrapped shift knob	-	-	-	STD	STD
Urethane shift knob	STD	STD	STD	-	-
Soft-touch door trim insert	-	-	-	-	STD
Chrome-finished inner door handles	-	-	-	STD	STD
Gloss black window switch panels	-	-	STD	-	-
Remote hood and fuel door release lever	STD	STD	STD	STD	STD
CONVENIENCE FEATURES					
7.0" Smartphone Link Thin-Display Audio (SDA)	-	-	STD	STD	STD
System with touchpad controller	-	-	-	-	-
7.0" Touch panel display audio system	STD	STD	-	-	-
Apple CarPlay™ and Android Auto™ compatibility	-	-	STD	STD	STD
SiriusXM™ Satellite Radio with 3-month subscription	-	-	STD	STD	STD
Mitsubishi Connect Telematics System with Safeguard and Remote services for 24 month trial subscription	-	-	-	STD	STD
AM/FM audio system	STD	STD	STD	STD	STD
Digital HD Radio*	STD	STD	STD	STD	STD
710-watt 9-speaker Rockford-Fosgate® premium audio system	-	-	-	-	OPT
Six speakers	-	-	-	STD	STD
Four speakers	STD	STD	STD	-	-
Bluetooth® wireless technology	STD	STD	STD	STD	STD
Steering wheel audio controls	STD	STD	STD	STD	STD
Steering wheel phone controls	STD	STD	STD	STD	STD
Steering wheel voice controls	-	-	STD	STD	STD
USB port	STD	STD	-	-	-
Dual USB ports	-	-	STD	STD	STD
Rearview camera	STD	STD	STD	STD	-
Multi-view camera system	-	-	-	-	STD
Head-Up Display (HUD)	-	-	-	-	STD
ECO indicator	STD	STD	STD	STD	STD
ECO drive mode switch	STD	STD	STD	STD	STD
S-AWC drive mode selector	-	STD	STD	STD	STD
Cruise control	STD	STD	STD	STD	STD
Automatic climate control	STD	STD	STD	-	-
Dual-zone automatic climate control	-	-	-	STD	STD
Micron air filtration	STD	STD	STD	STD	STD

FEATURE DESCRIPTION	ES 1.5T 2WD	ES1.5TS-AWC	LE1.5TS-AWC	SE1.5TS-AWC	SEL1.5TS-AWC
CONVENIENCE FEATURES (CONT.)					
Rear heater floor ducts	STD	STD	STD	STD	STD
FAST-Key passive entry system with push button start and panic feature	-	-	-	STD	STD
Remote keyless entry with panic feature	STD	STD	STD	-	-
Power door locks	STD	STD	STD	STD	STD
Power windows with driver's auto up/down	STD	STD	STD	STD	STD
Auto-dimming rearview mirror with Homelink®	-	-	-	-	OPT
Day/night rearview mirror	STD	STD	STD	STD	STD
12-volt accessory outlets (x2)	STD	STD	STD	STD	STD
Center console cupholders (x2) with illumination	STD	STD	STD	STD	STD
Center console box	STD	STD	STD	STD	STD
Center console box compartment tray	-	-	STD	STD	STD
Instrument panel lower storage space	STD	STD	STD	STD	STD
Front door panel storage pockets	STD	STD	STD	STD	STD
Front and rear door panel bottle holders	STD	STD	STD	STD	STD
Glove box	STD	STD	STD	STD	STD
Retractable assist grips (x4)	STD	STD	STD	STD	STD
SAFETY & SECURITY					
Anti-lock Braking System (ABS) with Electronic Brakeforce Distribution (EBD) and Brake Assist (BA)	STD	STD	STD	STD	STD
Electronic Parking Brake (EPB) with auto hold	-	-	-	STD	STD
Traction Control	STD	STD	STD	STD	STD
Active Stability Control (ASC)	STD	STD	STD	STD	STD
Hill Start Assist (HSA)	STD	STD	STD	STD	STD
Tire Pressure Monitoring System (TPMS)	STD	STD	STD	STD	STD
Blind Spot Warning (BSW) with Rear Cross Traffic Alert (RCTA) and Lane Change Assist (LCA)	-	-	-	STD	STD
Automatic High Beam (AHB) headlights	-	-	-	-	OPT
Forward Collision Mitigation (FCM)	-	-	-	-	OPT
Lane Departure Warning (LDW)	-	-	-	-	OPT
Adaptive Cruise Control (ACC)	-	-	-	-	OPT
Side curtain SRS airbags	STD	STD	STD	STD	STD
Front seat-mounted side SRS airbags	STD	STD	STD	STD	STD
Driver's knee SRS airbag	STD	STD	STD	STD	STD
Advanced dual-stage front SRS airbags	STD	STD	STD	STD	STD
Adjustable front shoulder belts with pretensioner	STD	STD	STD	STD	STD
Three-point seatbelts and head restraints for all seating positions	STD	STD	STD	STD	STD
LATCH child-restraint system	STD	STD	STD	STD	STD
Child safety rear (door locks)	STD	STD	STD	STD	STD
Anti-theft alarm system	STD	STD	STD	STD	STD
Anti-theft engine immobilizer	STD	STD	STD	STD	STD
RISE body construction	STD	STD	STD	STD	STD
FACTORY OPTION PACKAGES					
Touring Package	-	-	-	-	OPT
· Dual pane power panoramic sunroof					
· Black roof rails					
· Auto-dimming rearview mirror with Homelink®					
· Heated steering wheel					
· Heated rear seats					
· 710-watt 9-speaker Rockford-Fosgate® premium sound system					
· Automatic High Beam (AHB) headlights					
· Forward Collision Mitigation (FCM) system					
· Lane Departure Warning (LDW)					
· Adaptive Cruise Control (ACC)					

PORT ADDITIONAL EQUIPMENT	ES 1.5T 2WD	ES1.5TS-AWC	LE1.5TS-AWC	SE1.5TS-AWC	SEL1.5TS-AWC
Exterior Package	OPT	OPT	OPT	OPT	OPT
Front & rear corner extensions and side extensions					
Towing Package	OPT	OPT	OPT	OPT	OPT
· Tow hitch					
· Trailer tow wire harness					
Chrome Package	OPT	OPT	OPT	OPT	OPT
· Bright lower door molding					
· Side view mirror covers					
· Chrome door handle covers					
Protection Package	OPT	OPT	OPT	OPT	OPT
· Rear bumper step protector					
· Tailgate garnish					
LED Illumination Package	OPT	OPT	OPT	OPT	OPT
· Floor illumination (blue)					
· Illuminated door sills					
· Tailgate light					
Cargo Package	OPT	OPT	OPT	OPT	OPT
· Cargo mat					
· Cargo net					
Premium Exterior Package	-	-	OPT	OPT	OPT
· Front garnish					
· Rear garnish					
· Black lug nuts & wheel locks					
· Front & rear corner extensions and side extensions					
Garnish Package	OPT	OPT	OPT	OPT	OPT
· Front garnish					
· Rear garnish					
LED Interior Enhancement Package	OPT	OPT	OPT	OPT	OPT
· LED room, map, & cargo lights					
· Door switch panels - Gloss Black					
All Weather Package	OPT	OPT	OPT	OPT	OPT
· All-weather floor mats (4)					
· Cargo tray					
Roof Rails & Crossbars	OPT	OPT	OPT	OPT	OPT
· Roof rack crossbars					
· Roof rails					
Popular Equipment Value Package	-	-	OPT	OPT	OPT
· Black lug nuts & wheel locks					
· Rear bumper step protector					
· Tailgate garnish					
· Cargo mat					
· Cargo net					
Protection & All Weather Value Package	OPT	OPT	OPT	OPT	OPT
· Hood protector					
· Wheel locks					
· Front and rear mudguards					
· All weather floor mats (4)					
· Cargo tray					
ES Popular Equipment Value Package	OPT	OPT	-	-	-
· Cargo mat					
· Wheel locks					
· Rear bumper step protector					
· Tailgate garnish					
· Cargo net					

FEATURE DESCRIPTION	ES 2WD	ES S-AWC	LE S-AWC	SE S-AWC	SEL S-AWC
PORT ACCESSORIES					
Rear Park Assist Sensors	ACC	ACC	ACC	ACC	ACC
Hood Protector	ACC	ACC	ACC	ACC	ACC
Tonneau Cover	ACC	ACC	-	-	-
Wheel Locks	ACC	ACC	-	-	-
Black Lug Nuts & Wheel Locks	-	-	ACC	ACC	ACC
Front and Rear Mudguards	ACC	ACC	ACC	ACC	ACC
Roof Rack Crossbars	-	-	-	-	ACC
Roof Rails	ACC	ACC	ACC	ACC	ACC
ADDITIONAL EQUIPMENT ADDED					
Tonneau cover	-	-	ACC	ACC	ACC
Carpeted floor mats and portfolio	ACC	ACC	ACC	ACC	ACC

ENGINE	ES 2WD	ES S-AWC	LE S-AWC	SE S-AWC	SEL S-AWC
Type	1.5L L4 MIVEC + Direct Injection Turbo Charger	1.5L L4 MIVEC + Direct Injection Turbo Charger	1.5L L4 MIVEC + Direct Injection Turbo Charger	1.5L L4 MIVEC + Direct Injection Turbo Charger	1.5L L4 MIVEC + Direct Injection Turbo Charger
Engine Code	4B40 TC	4B40 TC	4B40 TC	4B40 TC	4B40 TC
Materials	Aluminum block/aluminum cylinder head	Aluminum block/aluminum cylinder head	Aluminum block/aluminum cylinder head	Aluminum block/aluminum cylinder head	Aluminum block/aluminum cylinder head
Bore x Stroke (mm)	75.0 x 84.8	75.0 x 84.8	75.0 x 84.8	75.0 x 84.8	75.0 x 84.8
Compression Ratio	10.0	10.0	10.0	10.0	10.0
Displacement (cc)	1,499	1,499	1,499	1,499	1,499
Horsepower	152 hp	152 hp	152 hp	152 hp	152 hp
Torque	184 lb-ft	184 lb-ft	184 lb-ft	184 lb-ft	184 lb-ft
Redline RPM	6000	6000	6000	6000	6000
Emissions	TIER 3 BIN 70 (50S) LEV III ULEV70	TIER 3 BIN 70 (50S) LEV III ULEV70	TIER 3 BIN 70 (50S) LEV III ULEV70	TIER 3 BIN 70 (50S) LEV III ULEV70	TIER 3 BIN 70 (50S) LEV III ULEV70
Engine Oil Type	OW 20	OW 20	OW 20	OW 20	OW 20
Recommended Fuel Type	Regular Unleaded	Regular Unleaded	Regular Unleaded	Regular Unleaded	Regular Unleaded
Radiator Core size	687.3x400x27	687.3x400x27	687.3x400x27	687.3x400x27	687.3x400x27

TRANSMISSION	ES 2WD	ES S-AWC	LE S-AWC	SE S-AWC	SEL S-AWC
8-speed CVT with Sport Mode	STD	STD	STD	STD	STD
CVT Automatic Ratios	2.631 - 0.378	2.631 - 0.378	2.631 - 0.378	2.631 - 0.378	2.631 - 0.378
1st	2.631	2.631	2.631	2.631	2.631
2nd	1.765	1.765	1.765	1.765	1.765
3rd	1.313	1.313	1.313	1.313	1.313
4th	1.046	1.046	1.046	1.046	1.046
5th	0.843	0.843	0.843	0.843	0.843
6th	0.664	0.664	0.664	0.664	0.664
7th	0.518	0.518	0.518	0.518	0.518
8th	0.404	0.404	0.404	0.404	0.404
Reverse	1.960	1.960	1.960	1.960	1.960
Final Drive	6.386	6.386	6.386	6.386	6.386

SUSPENSION	ES 2WD	ES S-AWC	LE S-AWC	SE S-AWC	SEL S-AWC
Front	MacPherson strut with stabilizer bar	MacPherson strut with stabilizer bar	MacPherson strut with stabilizer bar	MacPherson strut with stabilizer bar	MacPherson strut with stabilizer bar
Rear	Multi link with stabilizer bar	Multi link with stabilizer bar	Multi link with stabilizer bar	Multi link with stabilizer bar	Multi link with stabilizer bar

STEERING	ES 2WD	ES S-AWC	LE S-AWC	SE S-AWC	SEL S-AWC
Type	Electric Power Steering	Electric Power Steering	Electric Power Steering	Electric Power Steering	Electric Power Steering
Overall Ratio	14.7	14.6	14.6	14.6	14.6
Turns, lock to lock	2.9	2.9	2.9	2.9	2.9
Turning circle	35.0 ft	34.8 ft	34.8 ft	34.8 ft	34.8 ft

BRAKES/ TIRES/ WHEELS	ES 2WD	ES S-AWC	LE S-AWC	SE S-AWC	SEL S-AWC
Front	Ventilated disc, 11.6 in Single piston caliper	Ventilated disc, 11.6 in Single piston caliper	Ventilated disc, 11.6 in Single piston caliper	Ventilated disc, 11.6 in Single piston caliper	Ventilated disc, 11.6 in Single piston caliper
Rear	Solid disc, 11.9 in Single piston caliper	Solid disc, 11.9 in Single piston caliper	Solid disc, 11.9 in Single piston caliper	Solid disc, 11.9 in Single piston caliper	Solid disc, 11.9 in Single piston caliper
ABS	4 wheel, 4 channel, 4 sensors with Electronic Brake force Distribution (EBD)	4 wheel, 4 channel, 4 sensors with Electronic Brake force Distribution (EBD)	4 wheel, 4 channel, 4 sensors with Electronic Brake force Distribution (EBD)	4 wheel, 4 channel, 4 sensors with Electronic Brake force Distribution (EBD)	4 wheel, 4 channel, 4 sensors with Electronic Brake force Distribution (EBD)
Wheels	16 x 6 1/2 J Aluminum alloy	16 x 6 1/2 J Aluminum alloy	16 x 6 1/2 J Aluminum alloy	18 x 7 J Aluminum alloy	18 x 7 J Aluminum alloy
Tires	P215/70 R16	P215/70 R16	P215/70 R16	P225/55 R18	P225/55 R18
Temporary Spare Tire	T155/90D16 110M	T155/90D16 110M	T155/90D16 110M	T155/90D16 110M	T155/80D17 100M

CAPACITIES	ES 2WD	ES S-AWC	LE S-AWC	SE S-AWC	SEL S-AWC
Passenger Seating	5	5	5	5	5
Fuel	16.6 gallons	15.8 gallons	15.8 gallons	15.8 gallons	15.8 gallons
Oil	4.5 qt	4.5 qt	4.5 qt	4.5 qt	4.5 qt
Towing Capacity (lbs.)	1,500	1,500	1,500	1,500	1,500
Trailer Tongue Weight (lbs.)	150	150	150	150	150
WEIGHTS					
Curb Weight	3,307	3,450	3,483	3,516	3,516
GVWR	4,630	4,630	4,630	4,630	4,630
Weight distribution	59/41	58/42	58/42	58/42	58/42
FUEL ECONOMY					
City	26	25	25	25	25
Highway	29	28	26	26	26
Combined	27	26	25	25	25

FOOTNOTES

- Airbags are part of a Supplemental Restraint System (SRS). To decrease the risk of injury from a deploying airbag, always wear your seat belt, sit upright in the middle of the seat, and do not lean against the door. Always place children 12 and under in the rear seat and use appropriate child restraints. Never place a rear-facing infant restraint in the front seat. See your Owner's Manual and instructions provided with your child restraint for additional information.
- The Forward Collision Mitigation (FCM) system is a driver aid only and is not a substitute for safe and careful driving. Under certain circumstances, the system may not detect other vehicles and/or pedestrians correctly.
- The Blind Spot Warning (BSW) system is a driver aid only and is not a substitute for safe and careful driving. Under certain circumstances, this system may not detect other vehicles correctly.
- The Lane Change Assist (LCA) system is a driver aid only and is not a substitute for safe and careful driving. Under certain circumstances, this system may not detect other vehicles correctly.
- The Rear Cross Traffic Alert (RCTA) system is a driver aid only and is not a substitute for safe and careful driving. Under certain circumstances, this system may not detect other vehicles correctly.
- The Adaptive Cruise Control system is not a collision avoidance system or an automatic driving system. It is designed to use only limited braking and is never a substitute for safe and careful driving. Never rely solely on the Adaptive Cruise Control system.
- The Lane Departure Warning system is designed to read the lane marks under certain conditions. It is not a collision avoidance system and is not a substitute for safe and careful driving.
- The Multi-View Camera system is a driver aid only and is not a substitute for visual confirmation. The view on the screen is limited and objects outside that view will not be seen.
- Apple CarPlay™ and Siri® are trademarks of Apple Inc., registered in the U.S. and other countries. iPhone is a registered trademark of Apple Inc.
- Requires the Android Auto app on Google Play and an Android compatible smartphone running Android™ 5.0 Lollipop or higher. Google, Android, Android Auto and other marks are trademarks of Google LLC.
- ©2018 Rockford Corporation. All Rights Reserved. ROCKFORD FOSGATE, PUNCH and associated logos where applicable are registered trademarks of Rockford Corporation in the United States and/or other countries. Specifications subject to change without notice.
- Sirius® services require subscriptions, sold separately after 3-month trial included with vehicle purchase. See our Customer Agreement for complete terms at www.siriusxm.com. If you decide to continue your Sirius services at the end of your trial subscription, the plan you choose will automatically renew and bill at then current rates until you call SiriusXM® at 1-866-635-2349 to cancel. Programming subject to change. Sirius® satellite service available only to those at least 18 and older in the 48 contiguous USA, D.C., and PR (with coverage limitations). SiriusXM® and all related marks and logos are trademarks of SiriusXM® Radio Inc.
- The Bluetooth® word mark and logos are owned by the Bluetooth SIG, Inc., and any use of such marks by Mitsubishi is under license.
- Available in SE and SEL models. Included for two years as a new Mitsubishi owner of a MITSUBISHI CONNECT-capable vehicle. After the two-year trial, standard yearly subscription costs apply.

WARRANTIES	ES 2WD	ES S-AWC	LE S-AWC	SE S-AWC	SEL S-AWC
Basic	5-year / 60,000 miles	5-year / 60,000 miles	5-year / 60,000 miles	5-year / 60,000 miles	5-year / 60,000 miles
Limited Powertrain	10-year / 100,000 miles	10-year / 100,000 miles	10-year / 100,000 miles	10-year / 100,000 miles	10-year / 100,000 miles
Anti-corrosion	7-year / 100,000 miles	7-year / 100,000 miles	7-year / 100,000 miles	7-year / 100,000 miles	7-year / 100,000 miles
Roadside Assistance	STD	STD	STD	STD	STD

WARRANTY	ES 2WD	ES S-AWC	LE S-AWC	SE S-AWC	SEL S-AWC
Basic	5-year/60,000-mile limited warranty	5-year/60,000-mile limited warranty	5-year/60,000-mile limited warranty	5-year/60,000-mile limited warranty	5-year/60,000-mile limited warranty
Limited powertrain	10-year/100,000-mile limited warranty	10-year/100,000-mile limited warranty	10-year/100,000-mile limited warranty	10-year/100,000-mile limited warranty	10-year/100,000-mile limited warranty
Anti-corrosion	7-year/100,000-mile limited warranty	7-year/100,000-mile limited warranty	7-year/100,000-mile limited warranty	7-year/100,000-mile limited warranty	7-year/100,000-mile limited warranty
Roadside assistance	5-year/unlimited miles	5-year/unlimited miles	5-year/unlimited miles	5-year/unlimited miles	5-year/unlimited miles
Log on to our website and browse our full lineup of new vehicles, get MSRP and customer rebate information and "build" the Mitsubishi that's right for you. The site can help you locate your nearest dealer – or even have a dealer contact you.					
The 10-year/100,000-mile Powertrain Limited Warranty applies only to the original owner of new, retailed 2019 models purchased from an authorized Mitsubishi dealer. Subsequent owners receive the balance of the New Vehicle Limited Warranty of 5-years/60,000 miles.					
Technical data, equipment and options shown are based on the latest information available at the time of printing and are subject to change without notice. Colors may vary due to the printing process. Exterior and interior lights on vehicles shown may be illuminated for illustration purposes only. Vehicles are shown with optional equipment. Not all equipment is available on every model. For more complete details about equipment configuration and Mitsubishi Genuine Accessories, please contact your Mitsubishi Retailer.					

MITSUBISHICARS.COM