

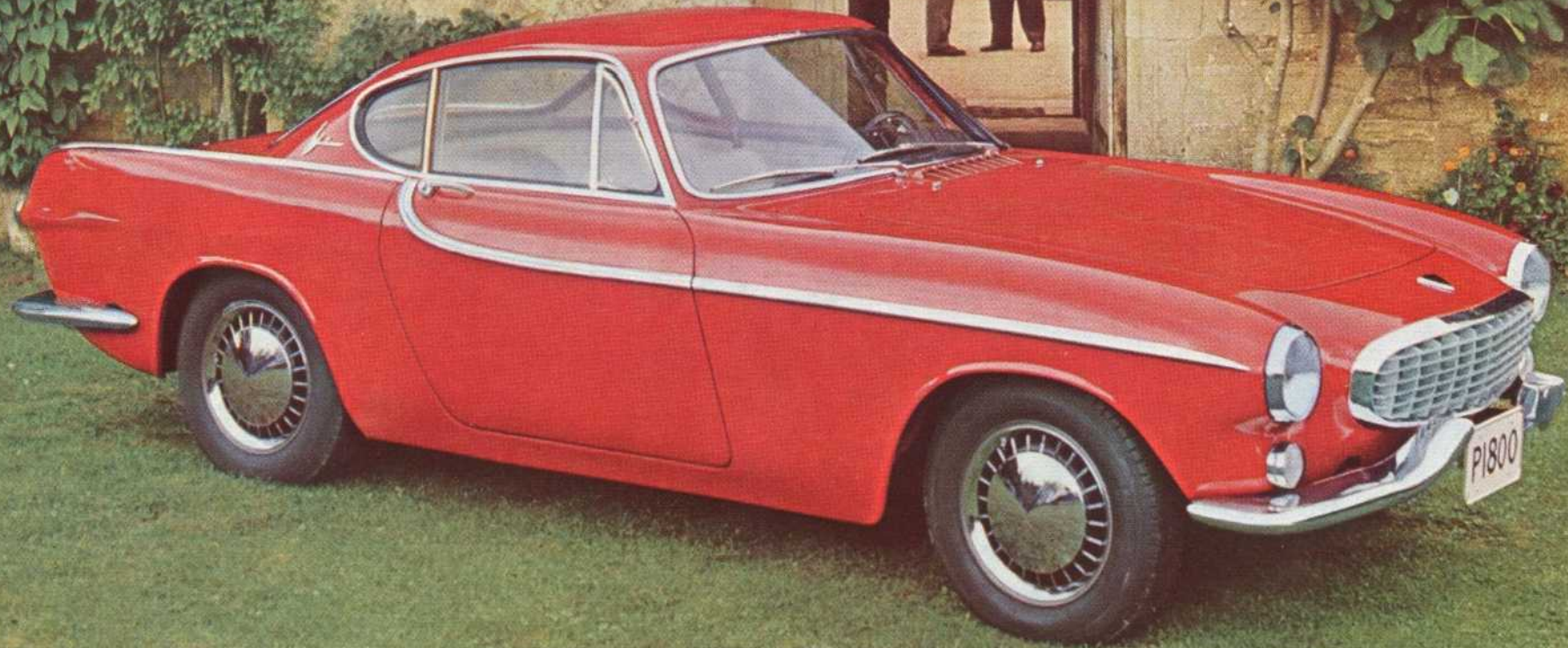







# VOLVO P 1800





The Volvo P 1800  is a car that attracts attention through the sheer beauty of its handsome lines and its effortless sparkling performance both in dense city traffic and on the open highway.  The power unit in this graceful and luxurious car is a thoroughbred one hundred horse power unit driving through a fully synchronized gearbox while the suspension is well in keeping with the technical perfection of the power system.  The Volvo P 1800 is the natural choice of those who make outstanding demands on luxurious comfort, relaxed safety and complete reliability.  The faultless road-holding qualities of this car together with safety details such as disc brakes on the front wheels, safety belts and padded dashboard make long-distance driving sheer enjoyment.  To drive the Volvo P 1800 with its carefully planned interior appointments, clearly visible instrumentation and conveniently located controls is an exhilarating experience.  This car is also designed for varying climatic conditions since the body is very effectively rust proofed and standard equipment includes a powerful heater-defroster and two separate air intakes as well as electric windscreen wipers and washers.  The Volvo P 1800 makes your everyday driving a pleasure and your leisure motoring is the unique experience of handling a car with superb performance and with effortless power at your command. 

## *a short Presentation of the P 1800*

- 100 h.p. sports engine with twin carburettors a)
- Disc brakes b)
- Braced-tread, 165-15 sports tyres c)
- 12-volt battery d)
- Fully synchronized four-speed gearbox e)
- Padded dashboard f)
- Dazzle-free rear view mirror g)
- Loud-tone horn h)
- Headlight flasher I)
- Overdrive (optional extra) k)
- Separate bucket seats I)
- Two occasional seats m)
- Parcel shelves n)
- Drum brakes o)

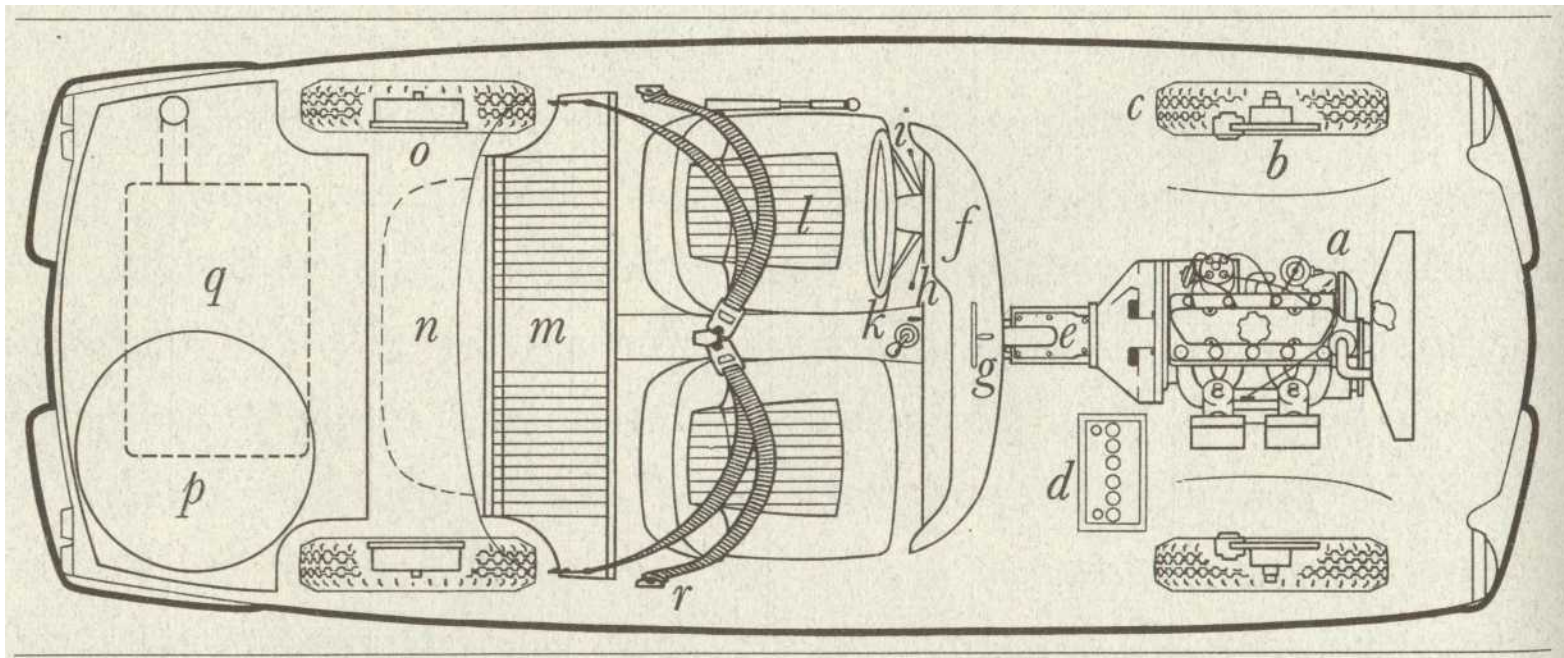

- Spare wheel p)
- Fuel tank (10 Imp. galls = 12 US galls.) q)
- Safety belts r)

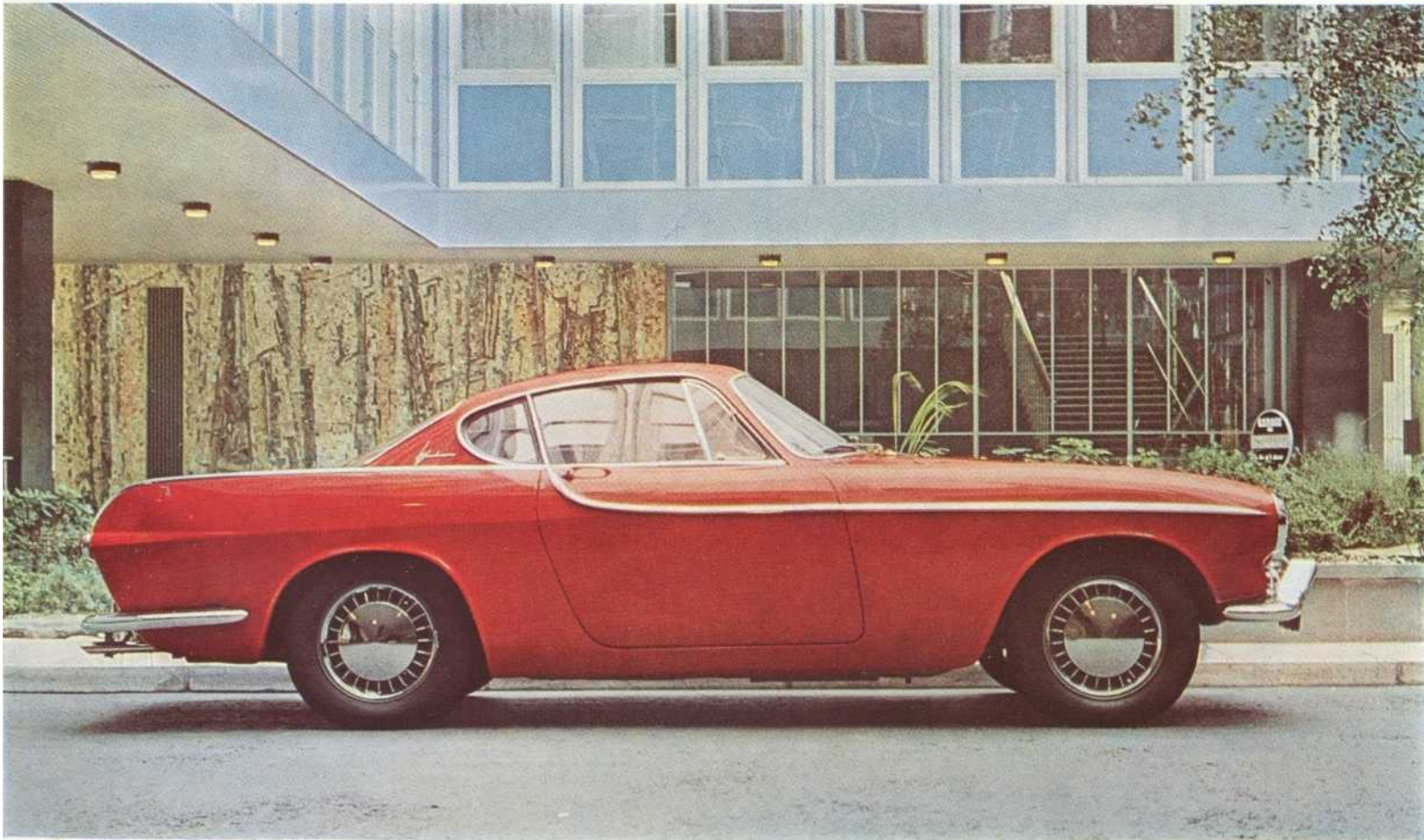



*The Volvo P 18 00 is a truly distinguished car, expressly designed and built to satisfy the most stringent demands made by those discerning people who are satisfied by nothing but the best quality, styling and performance.*

# *comprehensive instrumentation*

Switch for internal lighting a)

Choke b)

Control for fresh air intake c)

Windscreen wipers and washers d)

Lighting and instrument lighting e)

Revolution counter f)

Water and oil temperature gauges g)

Speedometer with:

mileometer

trip meter

Warning lamp for charging

Warning lamp for headlight beams

Warning lamp for direction indicator flashers

Fuel gauge i)

Oil pressure gauge k)

Clock l)

Warning lamp for overdrive m)

Ignition switch n)

Fan o)

Heater-defroster controls p)

Switch for overdrive q)

Cigarette lighter r)

Control for fresh air intake s)

Switch for map-reading lamp t)

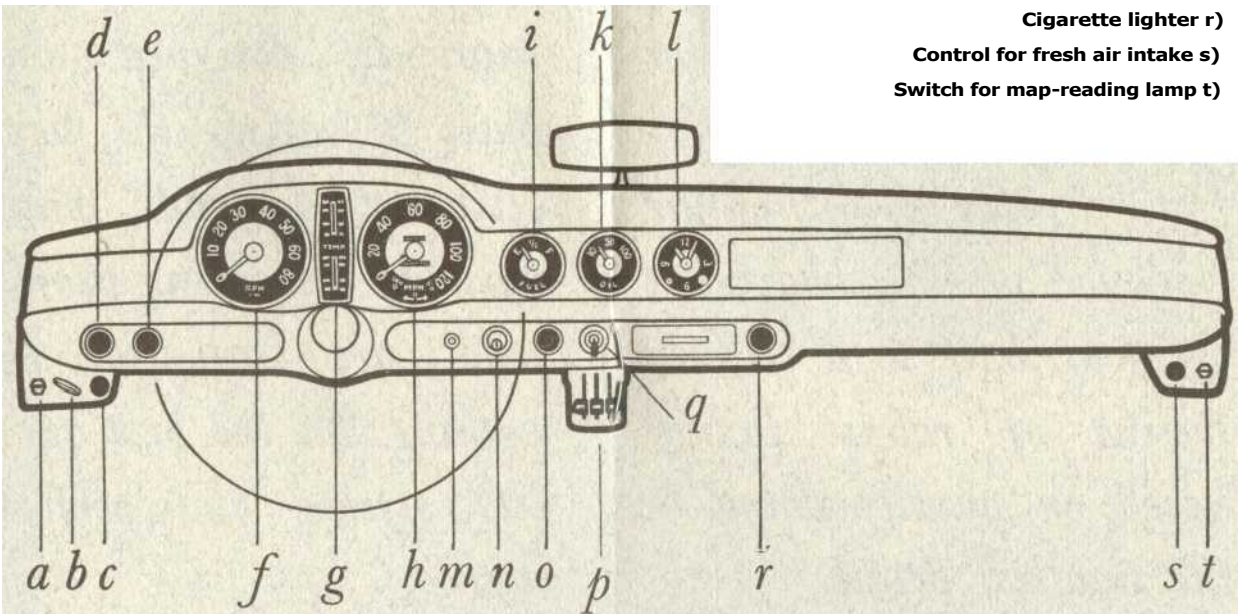



The comfortable front seats can easily be adjusted for your own individual requirements while the broad armrests on the doors also contribute to relaxed driving. There are two occasional rear seats and also two parcel shelves.

*To travel in a Volvo P 1800 is to experience motoring at its very best. The soft, but, at the same time, firm suspension, outstanding road-holding and the perfectly designed interior fittings which are in perfect harmony with the lithe elegance of the bodywork all contribute to a relaxed feeling of robust luxury based on quality down to the smallest detail.*



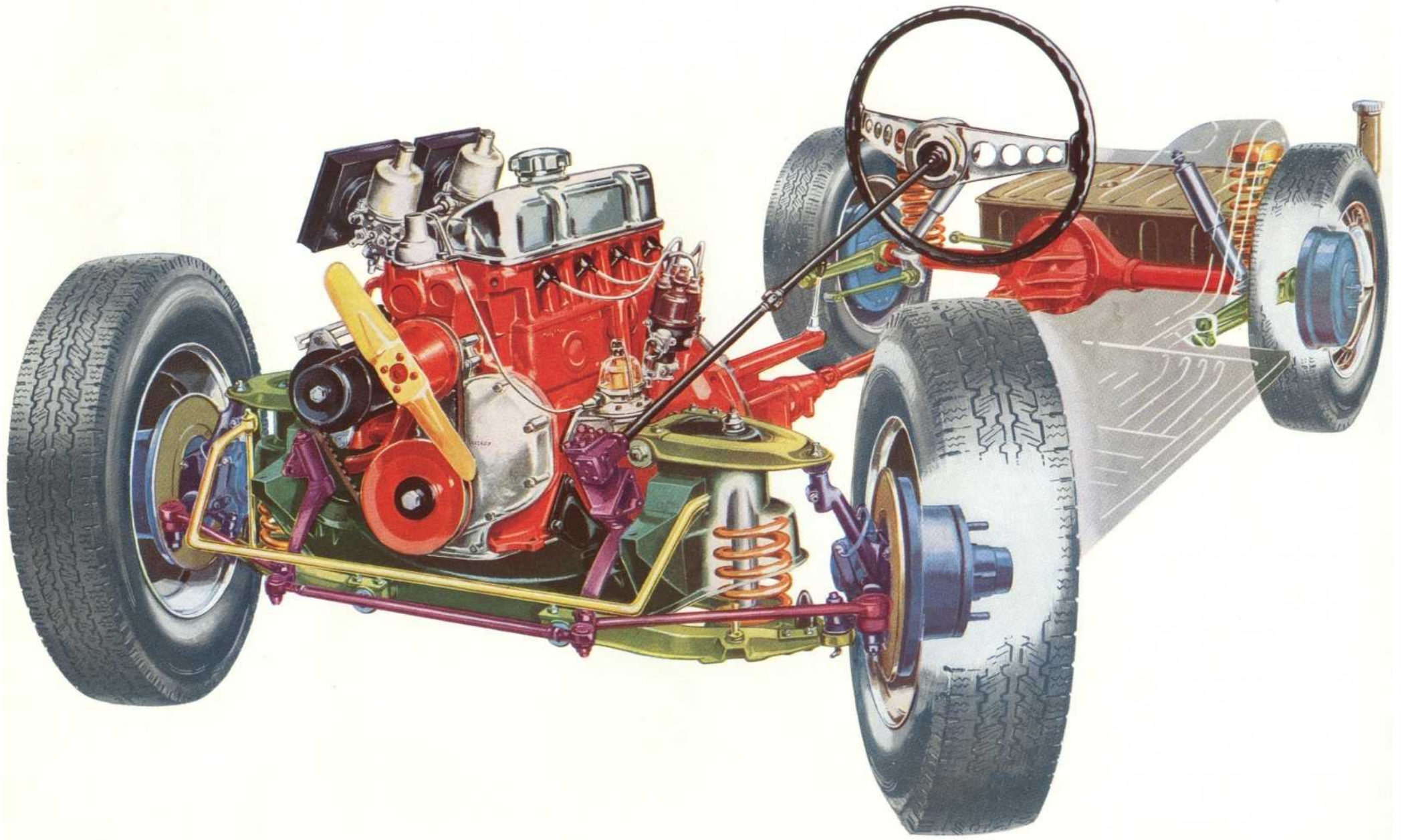

## specifications P 1800

### Engine

Four-cylinder, overhead valve  
Bore ..... 3.312" (84.14 mm)  
Stroke ..... 3.15" (80 mm)  
Capacity ..... 108.6 cu.in. (1.78 litres)  
Compression ratio .... 9.5:1  
Max. output ..... 100 h.p. (SAE) at  
5,500 r.p.m.  
Max. torque ..... 108 lb.ft. (15 kgm)  
at 4,000 r.p.m.  
Carburettors ..... Twin horizontal carburettors  
Full-flow oil filter .... Standard  
Oil cooler ..... Standard

### Battery

Voltage ..... 12 V  
Capacity ..... 58 amp./hrs.

### Dynamo

Fan-cooled with automatic voltage control  
Output ..... 360 W

### Starter motor

Output ..... 1 h.p.  
Starter switch incorporated in ignition switch which has also a special position whereby all the electrical equipment can be used even when the engine is switched off.  
There is a thief-proof armoured cable between the ignition switch and the ignition coil.

### Clutch

Hydraulically operated 8½" single dry plate clutch.

### Gearbox

Four-speed, fully synchronized  
Ratios ..... 1st 3.13:1  
" ..... 2nd 1.99:1  
" ..... 3rd 1.36:1  
" ..... 4th 1:1  
" ..... Reverse 3.25:1

### Overdrive

(Optional extra)  
Electrically operated  
Ratio ..... 0.756:1

### Propeller shaft

Divided for vibration-free operation. Centre bearing carried in rubber blocks as insulation from sound and vibration. Ball bearing in centre bearing requires no lubrication.

### Rear axle

Hypoid type final drive  
Ratio ..... 4.1:1  
When overdrive fitted  
Ratio ..... 4.56:1

### Steering gear

Cam and roller type  
Steering box ratio .... 15.5:1  
Left lock to right lock .. 3¼ turns of steering wheel  
Turning circle ..... approx. 31 ft. (9.5 m)

### Front wheel suspension

Independent suspension with coil springs and control arms. The control arms are carried in rubber bushings and ball joints. Stabilizer.

### Rear wheel suspension

Coil springs above rear axle  
Support arms carried in rubber  
Torque rods  
Track bar

### Shock absorbers

Double-acting, hydraulic, telescopic shock absorbers.

To ensure constant damping action even when driving at high speed on bad roads, each shock absorber has a freon-filled nylon cell.

### Foot brake

Servo-brake with 5½" servo cylinder  
Front:  
Disc brakes of three cylinder type, splash-protected and self-adjusting.  
Brake discs ..... 10⅞" × ½"  
Brake friction area on  
each front wheel ..... 14.5 sq.in. (92.5 sq.cm.)

### Rear:

V-type drum brakes (leading and trailing), hydraulic and self-centring.  
Size ..... 9 × 2"  
Brake friction area on  
each rear wheel ..... 32.5 sq.in. (210 sq.cm.)

### Hand brake

Operates separately on rear wheels.  
Hand brake lever located beside driving seat.

### Wheels and tyres

Pressed steel wheels (4½ J × 15)  
Braced-tread, sports tyres 165-15.

### Body

Integral construction, all-welded, steel body, fully rust-proofed.

### Fuel tank

Capacity ..... 10 Imp. gallons (12 US galls. = 45 litres)

### Lighting equipment

Headlight flasher operated by direction indicator lever.  
Flasher type direction indicators front and rear.  
Combined stop and tail lights with built-in reflectors.  
The internal lighting goes on when either of the doors is opened.  
Instrument lighting, rheostat-controlled.

### Instrumentation

See centre spread

### Main dimensions and weight

Wheelbase ..... 96½" (2450 mm)  
Track, front ..... 51¾" (1315 mm)  
Track, rear ..... 51¾" (1315 mm)  
Overall length ..... 173¼" (4400 mm)  
Overall width ..... 67" (1700 mm)  
Overall, height, unladen 50½" (1285 mm)  
Ground clearance, approx. 6" (155 mm)  
Kerb weight, approx. .. 2490 lb. (1130 kg)

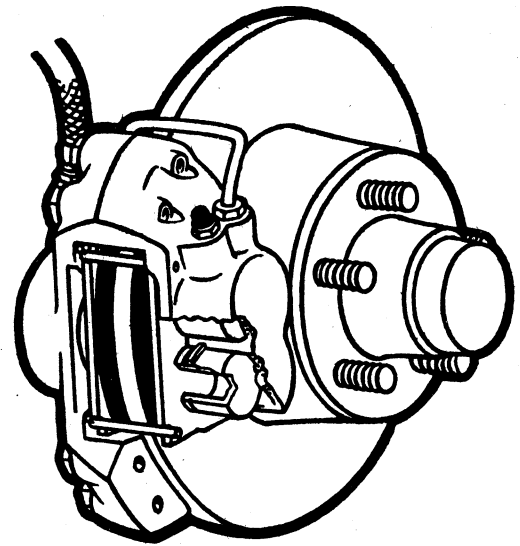
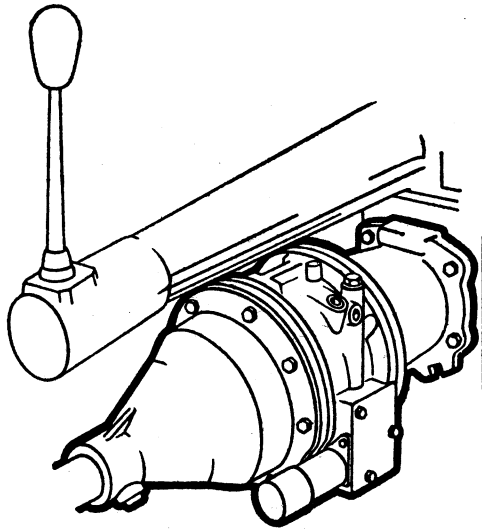
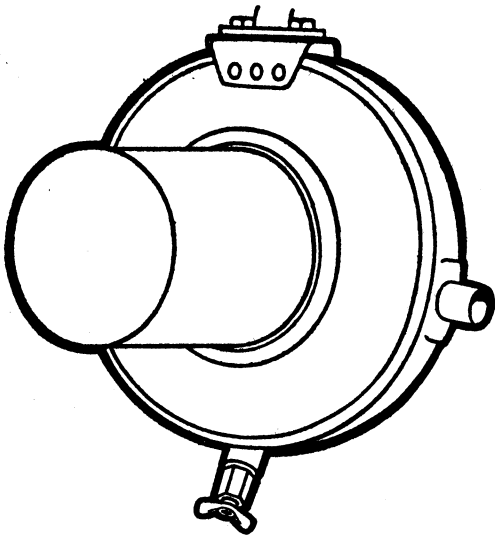

#### Other standard equipment

Twin horns and loud-tone horn.  
 Self-parking, two-speed, electric windscreen wipers.  
 Electric windscreen washers.  
 Thermostat-controlled fresh air heater.  
 Separate defroster control.  
 Two separate fresh air intakes for summer ventilation.  
 Safety belts.  
 Padded sun visors and dashboard,  
 Ashtray.  
 Cigarette lighter  
 Spare wheel,  
 Tool kit.

The factory reserves the right to modify prices, design and equipment.

#### Full-flow oil filter and oil cooler

A full-flow oil filter cleans the lubricating oil effectively and makes possible considerably longer periods between oil changes. The P 1800 has also an oil cooler as standard. An extra loop from the cooling system passes through the oil cooler and keeps the oil within the temperature range for which the lubricating properties are best.

#### Overdrive

An electrically-operated overdrive is available as optional extra and is controlled by means of a switch on the instrument panel. When the overdrive is cut in, engine speed is reduced and this decreases stress on the engine, gives good fuel economy and lower engine noise level.

#### Disc brakes

The Volvo P 1800 has liberally dimensioned disc brakes on the front wheels. The disc brakes always have the same smooth and positive braking effect no matter whether the speed of the car is high or low. Brake fade is eliminated in the case of repeated and intermittent braking due to the outstanding heat-conducting properties of the brake units.

Printed in Sweden. RK 118/3 8.61.15000.  
 Oscar Isacson's Boktryckeri AB Goteborg 1961.





SVERIGE SWEDEN SCHWEDEN SUÈDE SUECIA SVEZIA ZWEDEN

**AB VOLVO** Göteborg

