



THE ALL-NEW  
**VOLVO XC90**

# EXPERIENCE OUR IDEA OF LUXURY.

## *The all-new Volvo XC90.*

With its contemporary Scandinavian design and craftsmanship, the all-new XC90 redefines the luxury car for the 21<sup>st</sup> century. It is the safest, most advanced production car we have ever made; the most powerful and the most efficient.

It is a car designed for a demanding audience – you. Individuals who want an SUV that expresses who they are, and who want a vehicle that turns every drive into a memorable experience.

Every detail is designed to make driving more enjoyable and less stressful. Whether you're on your favorite country road or negotiating urban highway traffic, the all-new XC90's semi-autonomous driving technologies, first-class cabin, and attention to detail enhance your entire experience.

With the all-new XC90, we deliver on our promise to set the benchmark for luxury SUVs.







# WE ARE VOLVO CARS.

## *We put people first.*

We put people at the center of everything we do at Volvo Cars. Our design, our innovations, and our technologies are created to make life simpler and safer. Not just for you, but for your passengers and the world around you.

Scandinavian design begins by looking at who will use an object and then builds around that person and their needs.

It is a philosophy that we always use when designing our cars. Instead of trying to fit people around technology, we start by designing our cars around people.

In the all-new XC90, Scandinavian design, luxury, and technology converge to create the perfect experience for you and your passengers.



# ROAD PRESENCE.

*Be impressed, quite simply.*

You know you're looking at truly great design when what appears simple at a first glance turns out to be ingenious and stimulating once you discover the thoughts and details that make up the whole. As with any luxury item, its beauty might be obvious but its true value is only revealed when you discover the expertise, the

craftsmanship and the passion that went into making it. The all-new XC90 has these qualities. It marks a new chapter in Volvo Cars' history and introduces a design language that combines a strong presence with subtle details. It is perfectly executed and contemporary, yet timeless.





V O L V O

XC90

XC90

T6





# YOUR SANCTUARY.

## *Where everyone travels first class.*

With the interior of the all-new XC90, we have created a space that combines contemporary luxury with timeless seclusion. A haven where you and your passengers travel in first class, no matter where you sit. Each sculptured seat is sumptuously finished and beautifully designed, offering all the comfort you expect from a Volvo car, while ensuring generous legroom for rear passengers.

Designed in line with leading ergonomic research, the 10-way power front seats, including power lumbar support, ensure that you will easily find your perfect seated position. To enhance your comfort even further, you have the option of seat ventilation as

well as power-operated seat cushion extensions and side bolsters.

In the second row, the three individual seats are designed for maximum comfort. These seats slide and recline individually while the “theater seating” arrangement – where rear rows are positioned higher than the seats in front – give an excellent view forward.

Your younger passengers are equally important to us. Children who have outgrown child seats can use the integrated booster cushion in the second row. Also, every all-new XC90 has a large panoramic glass roof that perfectly complements the airy, uncluttered cabin.



Jewel-like treatments such as controls with diamond-patterned touch surfaces and translucent edges underline our designers' meticulous attention to detail.



Up to seven people ride comfortably in individual ergonomic seats. Each seat in the second and third rows can be folded flat into the floor, while 32 possible seating combinations provides superior versatility.



Thanks to the four-zone climate system, passengers in the outer two rear seats can set the temperature and fan speed to their individual taste – and the same goes for the driver and the front passenger.

# LUXURY DYNAMICS.

## *Firm control with a velvet touch.*

The advanced chassis of your all-new XC90 is tuned to deliver a smooth ride and precise handling. It results in a car that is just as comfortable and reassuring to drive on challenging roads as it is on the highway. Above all, you feel confident and in control behind the wheel. This makes the car easy to position on the road and effortless to maneuver, even in busy traffic situations and when negotiating tight parking spaces.

The all-new XC90 also incorporates our latest electronic support systems, which continuously adjust to road conditions and driving styles. For example, our Hill Start Assist function and Hill Descent Control make it easier to navigate steep inclines. All-wheel drive ensures that you make your way with total confidence in

unsettling weather conditions and on difficult roads.

For an ultra-smooth ride, the all-new XC90 is available with an air suspension system. This system includes advanced, electronically controlled dampers, which are connected to a computer that takes measurements and makes calculations up to 500 times a second, and adjusts the dampers accordingly.

The air suspension also allows you to raise or lower the car, making loading and unloading easier, as well as enhancing the all-new XC90's off-road capability. The Easy Ingress/Egress user setting, which is activated from the center touch screen, lowers the car by 1.57 inches when the engine is turned off. At higher speeds, the car lowers itself automatically to enhance stability.



Our optional air suspension technology offers you several dynamic chassis modes at the touch of an elegant drive mode selector: Comfort for maximum comfort, ECO for low fuel consumption, Dynamic for optimized aerodynamics and handling, and Off Road for increased ground clearance.

READ MORE AT [VOLVOCARS.US](http://VOLVOCARS.US)





*“The all-new XC90 puts you in control of advanced technology, in a way that’s human and natural.”*

## Intuitive technology to inform, entertain, and improve your driving experience.

An elegant 9-inch center touch screen display with a unique “portrait” orientation is central to the way the all-new XC90 makes your life simpler. It puts you in control of advanced technology, in a way that’s human and natural.

The information you need to see immediately, such as your current speed, road signs and navigation instructions, is right in front of you. This appears in the driver display or, if you have chosen the optional head-up display, hovering in your field of vision. Other critical information, such as 3D navigation maps and fuel levels, also appears in the driver display, while the rest of the functions are

located in the touch screen. This way you can stay focused on the road and enjoy the drive.

The touch screen’s portrait layout is a familiar one to anyone with a smartphone and gives you the optimum view of your current position and route ahead. We have replaced most of the physical buttons with one sleek control panel. Each function is organized in separate tiles and when activated, a tile expands to provide more detailed information. This enables access to the functions in one place, quickly and instinctively. No more complicated menus, just intuitive control.



**Talk to me.** To add to the relaxed driving experience, you can control many of the functions in your all-new XC90 using buttons integrated in the steering wheel, or through Voice Control technology. This enables you to use more natural voice commands and language, rather than a series of set prompts.

**The beauty of information.** With large touch buttons at the bottom of the screen, where they’re easy to reach, and information for viewing at the top, our tablet-sized 9-inch center display, with its portrait-format touch screen, is both innovative and practical. Its vertical format also makes following routes on maps easier as more of them can be displayed, and creates less need for scrolling.

READ MORE AT [VOLVOCARS.US](http://VOLVOCARS.US)

*SENSUS*



*SENSUS*

Bowers & Wilkins

**Premium Sound by Bowers & Wilkins - the perfect audio solution.** By partnering with one of the world's most renowned high-end audio manufacturers, the all-new XC90's Premium Sound by Bowers & Wilkins delivers results, wherever you are seated. A total of 1400 watts is outputted from 19 speakers and the development of a new type of "open air" subwoofer, placed by the wheelarch, means it can pulse more air and enables extremely low bass tones. Each individual component is designed and acoustically optimized for the all-new XC90. We have also developed a unique room transformation technology that allows you to recreate the acoustics of a specific room inside your car.

Bowers & Wilkins is a trademark of B&W Group Ltd.

*“Sensus is our way of enabling you to communicate instinctively with your car, and keeping you connected with your digital world.”*

## Connect to your car using all your senses.

Volvo Sensus is our way of enabling you to communicate instinctively with your car, and keeping you connected with your digital world.

Thanks to standard Sensus Connect, you can stream your favorite tunes from your device to your car via Bluetooth®. You can also use Bluetooth® or Wi-Fi tethering to connect your all-new XC90 to the internet via your device. This allows you to browse the web and access a variety of internet radio, navigation, and media

apps. With Sensus Navigation, you can view your route on the center display. Our smart navigation in-car apps further add to your convenience.

Whichever sound system you choose – High Performance Sound or the optional Premium Sound by Bowers & Wilkins – your musical experience will be exceptional.



**Advanced touch control.** The center display's highly advanced touch technology uses infrared film, giving you precise control with the barest touch of the screen – even when you are wearing gloves. Whether you push, sweep or pinch across the screen, you will be able to smoothly operate all functions with intuitive fingertip control. Anti-reflective coating minimizes reflections and glare, for optimum visibility in all light conditions.

**The short way home.** Sensus Navigation makes use of the 9-inch center display by showing your route in the largest possible format. With the optional head-up display, you will be guided by navigation arrows hovering in front of you. This is connected technology, so you have access to navigation apps that provide useful information. Best of all, Sensus Navigation has voice control, so all you have to do is say where you want to go.

READ MORE AT [VOLVOCARS.US](http://VOLVOCARS.US)



*INTELLISAFE*

**Light up the dark.** Our "Hammer of Thor" LED lights combine a distinctive look with safety and convenience. These LED lights have an especially wide and long light pattern, and our Active High Beam technology allows you to stay on high beam all the time. Driving in the dark just became a lot more enjoyable and safe.

FIND OUT MORE AT [VOLVOCARS.US](https://www.volvocars.us)



*"Our vision is to design cars that will not crash."*

## Intuitive safety by Volvo Cars. For you, your passengers and those around you.

Since the birth of Volvo Cars in 1927, keeping you safe has been part of our DNA. The three-point safety belt, acknowledged as one of the most important innovations of mankind, is just one life-saving technology that we invented.

But we keep setting our sights higher. Our vision is to design cars that will not crash; in the short term our aim is that by 2020 no one should be killed or seriously injured in a new Volvo car.

IntelliSafe is our comprehensive approach to keeping you – and the people around you – safe. In the all-new XC90, our City Safety collision avoidance technology can help you avoid or mitigate collisions with other cars, pedestrians, and cyclists in your path. City Safety also includes another world-first from Volvo Cars, intersection braking. This technology deploys the all-new

XC90's brakes automatically, should you turn into the path of an oncoming car at an intersection, to help limit the impact of a collision or prevent it altogether. Standard IntelliSafe technologies also include preventive safety features such as Lane Departure Warning and Electronic Stability Control, while Road Sign Information alerts drivers in advance about changes in speed limit, speed cameras, and road signs.

You can build on this by adding the optional Vision Package, which is designed to warn you of hazards around your car. The optional Convenience Package ensures a relaxed drive in the city or on the highway. It will help you keep a safe distance from the car ahead and, if needed, avoid lane drift by gently steering you back to your lane.

## INTELLISAFE



City Safety senses if you're about to collide with the car in front and applies the brakes if necessary. Active above 2.5mph, it can prevent a collision entirely at speeds up to 30mph. At higher speeds it can greatly reduce the severity of an impact. City Safety also brakes if you're about to turn into the path of an oncoming car, to avoid or mitigate a collision.

To protect those around you, City Safety watches out for pedestrians and cyclists, even at night. This is important because pedestrians and cyclists are harder to see in low light. Should a pedestrian or bike move into your path, City Safety warns you and will brake automatically if it senses that a collision is imminent.

The optional Vision Package includes our Blind Spot Information System, which alerts you to vehicles approaching alongside you. It also includes Rear Collision Mitigation, which detects vehicles approaching fast from behind. Cross Traffic Alert is also included – this feature makes it easier to reverse out of parking spaces by warning you of road users approaching on either side.



*“Relax and let your Volvo car do the hard work for you”*

## Semi-autonomous driving by Volvo Cars.

### For a safer and more convenient experience in city traffic.

Pilot Assist allows you to enjoy the benefits of semi-autonomous driving. This revolutionary feature ensures every journey is effortless, even when you're on congested city streets.

As part of the optional Convenience Package, Pilot Assist supports you by automatically adjusting the steering

to keep the car within its lane at speeds up to 30mph. Working in harmony with Adaptive Cruise Control, which adapts your speed to the vehicle in front, Pilot Assist allows you to relax and let your Volvo car do the hard work for you. All you need to do is keep your hands on the wheel.



# INTELLISAFE

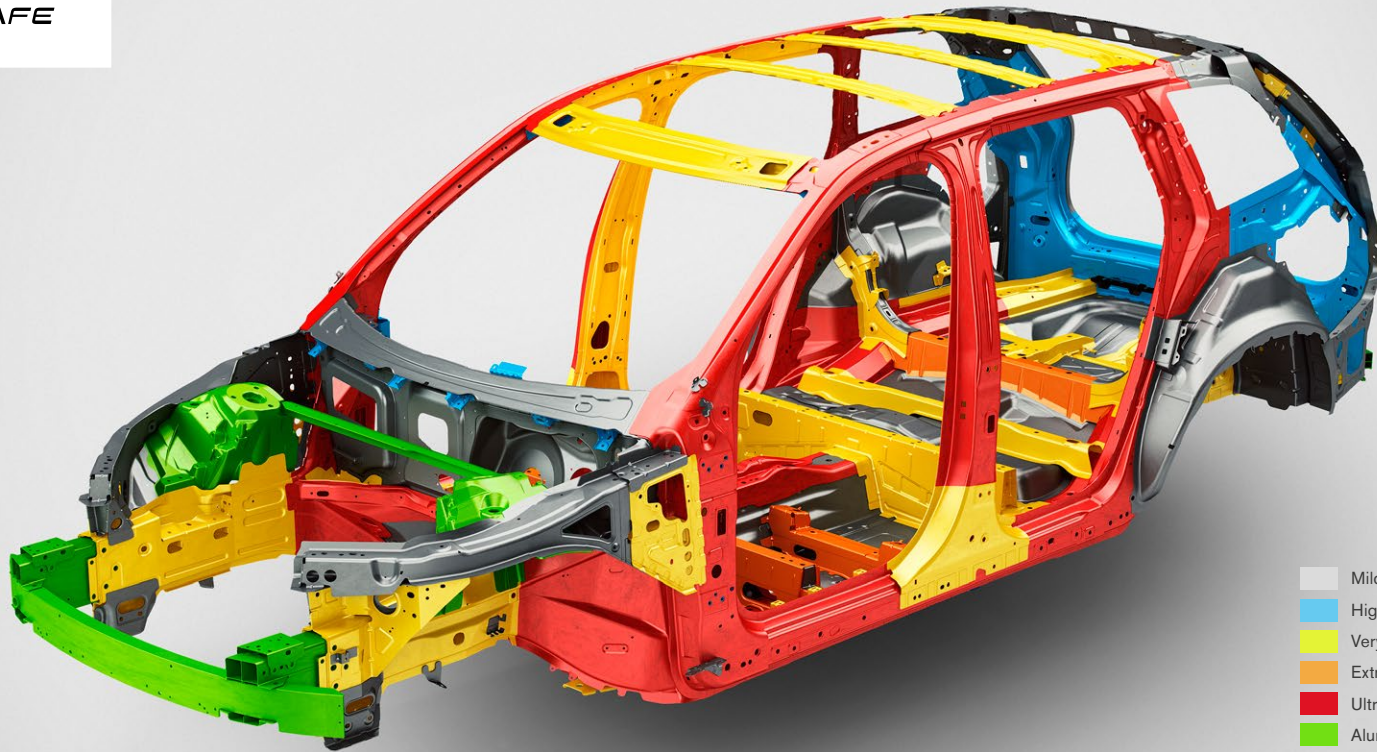

- Mild steel
- High strength steel
- Very high strength steel
- Extra high strength steel
- Ultra high strength steel
- Aluminum



## We help protect what is important to you – by design.

Volvo Cars makes your life safer, with our active safety technology and by designing protective strength around the passenger compartment.

We pioneered the use of ultra-high strength steel in our body structure. In the all-new XC90, around 40% of the total body weight consists of this extremely tough material, but an intelligent structure needs to dissipate energy as well as resist it. This is why we strategically placed softer segments in different steel qualities, which act as front and rear crumple zones.

Our run-off-road protection technology senses if you are going to depart the road unexpectedly or be involved in a collision, and automatically tightens the front safety belts with two levels of force to keep you in a safe position. A safety world-first for Volvo Cars, it helps protect your spine if the car encounters rough terrain during an accident. We designed the front seat frames and seat cushions to help absorb severe vertical forces. If a collision is avoided, the front safety belts unroll again without needing to be serviced.



We designed the safety technologies to help protect people of all sizes and all ages. For example, children aged three years or over will ride in comfort and safely positioned when they are seated on our integrated booster cushion on the second row's center position.

At Volvo Cars we help protect not just you and your passengers, but other motorists too. We developed our lower crash structure so that the all-new XC90 is compatible with the crumple zones of smaller cars – because if you're big, you also have to be kind.

**Our CleanZone technology filters out particles and harmful gases, ensuring that the air inside your car is clean even if you are driving through polluted areas.** As part of CleanZone, we test all of our interiors to ensure that none of them emit any odors or harmful gases, taking care that all of our materials are hypo-allergenic. Then there's our newly developed cabin filter that greatly reduces the levels of dust, pollen, and particles entering the cabin. On top of this, our CleanZone interior air quality system has an active charcoal multi-filter that protects you and your passengers from harmful vehicle emissions, such as carbon monoxide, nitrous oxides, and diesel particles. The system also opens and closes the air vents automatically. It constantly measures the quality of the air entering the cabin and switches to recirculation mode if it detects harmful gases, opening the vents again when conditions have improved.

READ MORE AT [VOLVOCARS.US](https://www.volvocars.us)

A close-up photograph of a car's interior air vent. The vent is black with horizontal slats. The word "CLEANZONE" is printed in white on the lower part of the vent. Below the vent is a control knob with a textured, honeycomb-like surface. The surrounding area is dark, likely the car's dashboard or center console.

CLEANZONE



**Park with confidence – wherever you go.** Tight parking areas and narrow city streets can be easily maneuvered with the optional 360° camera. You will get a bird's-eye, uninterrupted view of the car's surroundings on the center display. If you would like your car to park for you, then let the optional Park Assist Pilot do the work and maneuver you into a vacant space. Not only can this technology parallel park, it can also handle perpendicular parking. Once it detects a suitable gap, it takes over the steering and guides your all-new XC90 into place – all you need to control is the brake and the accelerator. The technology is so precise it can park in spaces you would not normally consider. When parallel parking, for example, a space just 1.2 times the length of the car is enough. It is like having a valet to park your car for you, everywhere you go.

READ MORE AT [VOLVOCARS.US](http://VOLVOCARS.US)

*DRIVE-E*





*“Our all-new T6 powertrain gives you an exhilarating driving experience with smooth, instant response and reduced environmental impact.”*

## Efficient power, instant response and adaptability. The T6 AWD.

Our new lightweight Drive-E powertrains give you efficient power with a no-compromise driving experience. We believe they redefine how luxury cars will be powered in the 21<sup>st</sup> century.

The all-new supercharged and turbocharged four-cylinder T6 engine exemplifies this intelligent, all-embracing approach. It gives you an exhilarating driving experience with smooth, instant response at all revs – just the performance and driving enjoyment you'd expect from a luxury SUV. Yet thanks to our unrelenting commitment to efficiency, this superb driveability is combined with reduced environmental impact, low fuel consumption and less harmful emissions.

It is versatile too, allowing you to choose between drive modes for the engine, gearbox, and optional air suspension according to your preferences or the driving conditions. In Dynamic mode, you can enjoy a more sporty driving experience, with quicker responses. In Eco mode, the engine and gearbox are calibrated for the lowest possible fuel consumption. A start/stop system also helps to improve fuel efficiency.

To complete your driving experience, we have mated this 316hp /295 lb/ft powertrain with our all-new automatic eight-speed Geartronic<sup>®</sup> transmission, which ensures you get optimum performance and comfort at any speed.

*"The all-new XC90 T8 Twin Engine feels truly special behind the wheel, allowing you to switch between 400hp AWD performance and pure electric driving at the touch of a button."*

## Power without compromise. The T8 Twin Engine plug-in hybrid.

By combining a state-of-the-art Drive-E petrol engine with a powerful electric motor, the all-new XC90 T8 Twin Engine gives you thrilling performance and exceptional efficiency. Fully charged, the T8 Twin Engine provides 17 miles (estimated) of pure electric driving – sufficient to cover most commutes and other everyday scenarios. On those occasions when you require more power, the 313hp Drive-E powertrain starts automatically, whenever it is called upon.

The T8 Twin Engine is our range-topping model and feels truly special behind the wheel, allowing you to switch between 400hp AWD performance and pure electric driving at the touch of a button. With distinctive drive modes, including Pure Electric, Hybrid, and Power, it adapts to your every need. In fact, your all-new XC90 can be anything you want it to be – a silent-running pure electric city car, a smart plug-in-hybrid, a seven-seat SUV, or a high-performance luxury car, all without ever having to compromise.



**Our T8 Twin Engine AWD plug-in hybrid makes every journey an event, combining the modern feel of zero-emission driving with astonishing performance.** As well as its twin-charged, high-performance Drive-E petrol engine, the all-new XC90 T8 Twin Engine has a powerful electric motor, resulting in a combined output of 400hp and a 0-60mph time of 5.3 seconds (estimated). The powertrain switches smoothly between sources in hybrid mode. In electric mode it gives a near-silent driving experience.

The electric motor is powered by high-capacity batteries that are mounted centrally along the transmission tunnel – an intelligent positioning that gives excellent weight distribution and, consequently, outstanding handling. It also means that with the all-new XC90, Volvo Cars is the only manufacturer that offers a hybrid SUV with seven seats. As a symbol of the Pure electric mode, the gear shifter in traditional Swedish crystal is handmade for you by Orrefors™.

READ MORE AT [VOLVOCARS.US](http://VOLVOCARS.US)



## The choice is yours.

With three trim levels and a range of options and accessories, you can create the all-new XC90 that best fits your lifestyle and personality. Even the standard trim level, Momentum, is designed to meet the high levels of refinement that a luxury SUV owner demands. If you're aiming for top-of-the range luxury, the Inscription trim level focuses on craftsmanship, elegance and exclusiveness. Finally, the R-Design is all about a more sporty, dynamic expression of your SUV, both inside and out.

### VOLVO XC90 MOMENTUM



Picture shows T6 Momentum with optional LED headlights.

- High-gloss black grille with glossy chrome frame
- Color-coordinated lower body moldings
- Black lower outer grilles with chrome deco strip
- Roof rails in matte anodized aluminum with Charcoal feet
- Side window frames with high-gloss chrome finish
- Matte Silver Bright metallic skid plate, dual integrated tailpipes, and "whiskers" around rear reflector in body color
- 19", 10-spoke Turbine, Silver Bright alloy wheels
- Cross-brushed aluminum inlays
- Comfort seats with leather upholstery



## VOLVO XC90 R-DESIGN



- Horizontal mesh grille in high-gloss black paint, silk metal frame
- R-Design color-coordinated lower body moldings
- Dark grey lower outer grilles with high-gloss black insert
- Integrated roof rails in high-gloss anodized aluminum, flush with the roof
- Door mirror caps with semi-matte silver finish
- Side window frames with silk metal finish
- Dark grey skid plate with body-colored insert, dual integrated tailpipes, "whiskers" around rear reflector with high-gloss black finish
- 20" 5-spoke, Diamond Cut/Tech Matte Grey alloy wheels
- Metal mesh aluminum inlays
- Contour seats with Nubuck and Nappa leather upholstery



## VOLVO XC90 INSCRIPTION



Picture shows optional 21" 8-spoke Alloy Wheels in Silver Bright Diamond Cut.

- Matte silver-colored grille with waterfall theme, glossy chrome frame
- Color-coordinated lower body moldings with high-gloss chrome strip and Inscription logo
- Black lower outer grilles with chrome deco strip
- Integrated roof rails in high-gloss anodized aluminum, flush with the roof
- Side window frames with high-gloss chrome finish
- Matte Silver Bright metallic skid plate, dual integrated tailpipes, "whiskers" around rear reflector with high-gloss chrome finish
- 20", 10-spoke, Diamond Cut/Tinted Silver alloy wheels
- Linear walnut wood inlays
- Comfort seats with perforated Nappa leather upholstery



VOLVO XC90



Contour seat



**Comfort seat**



**Cross-brushed aluminum**  
Momentum



**Dark flame birch**  
Optional for Momentum

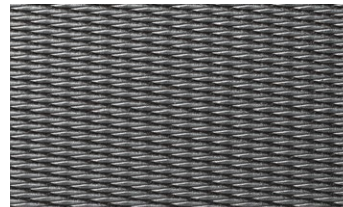

**Metal mesh**  
R-Design

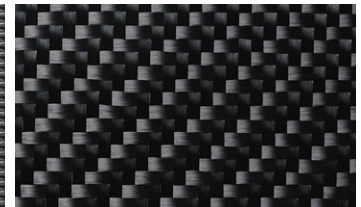

**Carbon fiber**  
Optional for R-Design

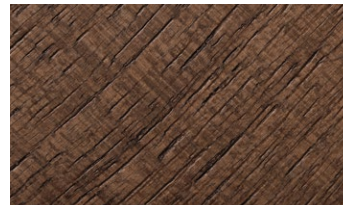

**Linear walnut**  
Inscription

VOLVO XC90



**RA00** | Charcoal leather



**RA20** | Amber leather



**RC00** | Charcoal perforated Nappa leather



**RC20** | Amber perforated Nappa leather



**RB01** | Charcoal Nappa leather with contour seat



**RB21** | Amber Nappa leather with contour seat





**UA00** | Blond leather in Blond/Charcoal interior



**WA00** | Blond leather in blond interior



**UC00** | Blond perforated Nappa leather in Blond/Charcoal interior



**WC00** | Blond perforated nappa leather in blond interior



**UB01** | Blond Nappa leather in Blond/Charcoal interior with contour seat



**RB0R** | Charcoal Nubuck and Nappa leather in Charcoal interior

# XC90 T6 AWD

316 hp, 295 lb/ft torque, direct-injected turbo and supercharged engine,  
8-speed Geartronic automatic with start/stop & Adaptive Shift

	Momentum	Inscription	R-Design		Momentum	Inscription	R-Design
<b>Value:</b>				Third-row seating (seven seats)	●	●	●
Complimentary Factory Scheduled Maintenance for 3 years, 36,000 miles. 4 years, 50,000 miles New Car Warranty.	●	●	●	Sensus Navigation	●	●	●
<b>Safety</b>				Volvo Sensus Connect with 9-inch touchscreen and six-month complimentary subscription	●	●	●
Volvo On Call includes: Convenience features – remote lock/unlock, Send to Car, vehicle tracking with six-month subscription	●	●	●	Voice control	●	●	●
Roll Stability Control	●	●	●	12.3-inch digital instrument display	●	●	●
City Safety collision avoidance, including pedestrian & cyclist detection (day and night)	●	●	●	High-performance 330-watt audio system with 10 speakers, 1 USB and AUX input	●	●	●
Run-off-road protection	●	●	●	Sirius™ satellite radio with six-month subscription	●	●	●
Lane Departure Warning	●	●	●	Four-zone electronic climate control	●	●	●
Road Sign Information	●	●	●	CleanZone air quality system	●	●	●
Driver Alert	●	●	●	Leather steering wheel	●	●	●
<b>Exterior</b>				Aluminum inlays	●	N/A	N/A
Laminated panoramic sunroof with power sunshade	●	●	●	Aluminum Volvo tread plates	●	N/A	N/A
19" 10-spoke Turbine alloy wheels in Silver Bright	●	N/A	N/A	Auto-dimming mirror	●	●	●
Adjustable drive mode settings	●	●	●	<b>Versatility</b>			
Aluminum roof rails	●	N/A	N/A	Keyless entry and drive	●	●	●
Dual integrated tailpipes	●	●	●	Rear park assist camera	●	●	●
LED fog lights with corner illumination	●	●	●	Hands-free power tailgate	●	●	●
High-gloss black front grille	●	N/A	●	Rear park assist	●	●	●
Tinted windows (rear & cargo)	●	●	●	Cargo cover	●	●	●
Door handle illumination	●	●	●	Cargo divider, upper cargo floor	●	●	●
<b>Interior</b>				Power-folding rear head restraints (outer positions)	●	●	●
Leather upholstery (seating surfaces)	●	N/A	N/A	Power child safety locks	●	●	●
10-way power front seats incl. power lumbar and driver seat memory	●	●	●	Tempa spare wheel, including jack kit	●	●	●
Heated front seats	●	●	●	Aluminum cargo scuff plate	●	●	●

	Momentum	Inscription	R-Design
<b>Inscription &amp; R-Design</b>			
LED headlights with Active Bending Lights (ABL), Auto Highbeam (AHB) & Thor's Hammer daytime running lights	N/A	●	●
High-pressure headlight cleaners	N/A	●	●
Illuminated tread plates	N/A	●	●
Integrated aluminum roof rails	N/A	●	●
High-level interior illumination	N/A	●	●
<b>Inscription features</b>			
Silver Matte front grille	N/A	●	N/A
Lower door molding with Inscription logo	N/A	●	N/A
Chrome rear fascia accents	N/A	●	N/A
Inscription tailgate badge	N/A	●	N/A
20" 10-spoke Tinted Silver alloy wheels	N/A	●	N/A
Nappa leather upholstery	N/A	●	N/A
Nappa leather dashboard and upper door panels	N/A	●	N/A
Ventilated front seating	N/A	●	N/A
Power side support for front seats	N/A	●	N/A
Power cushion extension for front seats	N/A	●	N/A
Linear walnut wood inlays	N/A	●	N/A
Inscription mats, including cargo area	N/A	●	N/A
Nappa leather key fob, color-coordinated	N/A	●	N/A
Rear sun curtains for rear side doors	N/A	●	N/A
Inscription start-up sequence (digital display)	N/A	●	N/A

	Momentum	Inscription	R-Design
<b>R-Design features</b>			
R-Design lower front spoiler	N/A	N/A	●
R-Design front grille	N/A	N/A	●
R-Design pedals	N/A	N/A	●
R-Design silk metal window trim	N/A	N/A	●
R-Design dual integrated tailpipes	N/A	N/A	●
R-Design silk metal mirror covers	N/A	N/A	●
R-Design perforated leather gearshift knob	N/A	N/A	●
R-Design tailgate badge	N/A	N/A	●
R-Design 20" 5-spoke alloy wheels in Diamond Cut/Tech Matte Grey	N/A	N/A	●
R-Design nubuck/nappa leather contour seats	N/A	N/A	●
Power cushion extension for front seats	N/A	N/A	●
Metal mesh aluminum inlays	N/A	N/A	●
Illuminated tread plates, R-Design logo	N/A	N/A	●
R-Design perforated leather steering wheel	N/A	N/A	●
Steering wheel gear shift paddles	N/A	N/A	●
R-Design nappa leather key fob	N/A	N/A	●
Charcoal headlining	N/A	N/A	●
R-Design mats, front/rear	N/A	N/A	●
R-Design start-up sequence (digital display)	N/A	N/A	●

● = Standard N/A = Not available

# XC90 T8 TWIN ENGINE AWD PLUG-IN HYBRID

313 hp, direct-injected turbo and supercharged engine with 87 hp electric motor,  
8-speed Geartronic automatic with start/stop & Shift by Wire

	Momentum	Inscription	R-Design		Momentum	Inscription	R-Design
<b>Value:</b>				<b>Interior</b>			
Complimentary Factory Scheduled Maintenance for 3 years, 36,000 miles. 4 years, 50,000 miles New Car Warranty.	●	●	●	Crystal gear shift knob by Orrefors®	●	●	●
<b>Safety</b>				Illuminated sill plates	●	●	●
Volvo On Call includes: Convenience features – remote lock/unlock, Send to Car, vehicle tracking with six-month subscription	●	●	●	High-Level interior illumination	●	●	●
Roll Stability Control	●	●	●	Power cushion extension, front seats	●	●	●
City Safety collision avoidance, including pedestrian & cyclist detection (day and night)	●	●	●	Leather upholstery (seating surfaces)	●	N/A	N/A
Run-off-road protection	●	●	●	10-way power front seats incl. power lumbar and driver seat memory	●	●	●
Lane Departure Warning	●	●	●	Heated front seats	●	●	●
Road Sign Information	●	●	●	Third-row seating (seven seats)	●	●	●
Driver Alert	●	●	●	Sensus Navigation	●	●	●
<b>Exterior</b>				Volvo Sensus Connect with 9-inch touchscreen and six-month complimentary subscription	●	●	●
eAWD	●	●	●	Voice control	●	●	●
LED headlights with Active Bending Lights (ABL), Auto Highbeam (AHB) & Thor's Hammer daytime running lights	●	●	●	12.3-inch digital instrument display	●	●	●
High-pressure headlight cleaners	●	●	●	High-performance 330-watt audio system with 10 speakers, 1 USB and AUX input	●	●	●
Laminated panoramic sunroof with power sunshade	●	●	●	Sirius™ satellite radio with six-month subscription	●	●	●
19" 6-spoke Turbine alloy wheels in Silver Bright	●	N/A	N/A	Four-zone electronic climate control	●	●	●
Adjustable drive mode settings	●	●	●	CleanZone air quality system	●	●	●
Aluminum roof rails	●	N/A	N/A	Leather steering wheel	●	●	●
Dual integrated tailpipes	●	●	●	Aluminum inlays	●	N/A	N/A
High-gloss black front grille	●	N/A	●	Aluminum Volvo tread plates	●	N/A	N/A
Tinted windows (rear & cargo)	●	●	●	Auto-dimming mirror	●	●	●
Door handle illumination	●	●	●	<b>Versatility</b>			
				Keyless entry and drive	●	●	●
				Rear park assist camera	●	●	●
				Hands-free power tailgate	●	●	●

	Momentum	Inscription	R-Design
Rear park assist	●	●	●
Cargo cover	●	●	●
Cargo divider, upper cargo floor	●	●	●
Power-folding rear head restraints (outer positions)	●	●	●
Power child safety locks	●	●	●
Tire Repair Kit	●	●	●
Aluminum cargo scuff plate	●	●	●
LED headlights with Active Bending Lights (ABL), Auto Highbeam (AHB) & Thor's Hammer daytime running lights	●	●	●
High-pressure headlight cleaners	●	●	●
Illuminated tread plates	●	●	●
Integrated aluminum roof rails	N/A	●	●
High-level interior illumination	●	●	●
<b>Inscription features</b>			
Silver Matte front grille	N/A	●	N/A
Lower door molding with Inscription logo	N/A	●	N/A
Chrome rear fascia accents	N/A	●	N/A
Inscription tailgate badge	N/A	●	N/A
20" 10-spoke Tinted Silver alloy wheels	N/A	●	N/A
Nappa leather upholstery	N/A	●	N/A
Nappa leather dashboard and upper door panels	N/A	●	N/A
Ventilated front seating	N/A	●	N/A
Power side support for front seats	N/A	●	N/A
Power cushion extension for front seats	N/A	●	N/A
Linear walnut wood inlays	N/A	●	N/A
Inscription mats, including cargo area	N/A	●	N/A

	Momentum	Inscription	R-Design
Nappa leather key fob, color-coordinated	N/A	●	N/A
Rear sun curtains for rear side doors	N/A	●	N/A
Inscription start-up sequence (digital display)	N/A	●	N/A
<b>R-Design features</b>			
R-Design lower front spoiler	N/A	N/A	●
R-Design front grille	N/A	N/A	●
R-Design pedals	N/A	N/A	●
R-Design silk metal window trim	N/A	N/A	●
R-Design dual integrated tailpipes	N/A	N/A	●
R-Design silk metal mirror covers	N/A	N/A	●
R-Design perforated leather gearshift knob	N/A	N/A	●
R-Design tailgate badge	N/A	N/A	●
R-Design 20" 5-spoke alloy wheels in Diamond Cut/Tech Matte Grey	N/A	N/A	●
R-Design nubuck/nappa leather contour seats	N/A	N/A	●
Power cushion extension for front seats	N/A	N/A	●
Metal mesh aluminum inlays	N/A	N/A	●
Illuminated tread plates, R-Design logo	N/A	N/A	●
R-Design perforated leather steering wheel	N/A	N/A	●
Steering wheel gear shift paddles	N/A	N/A	●
R-Design nappa leather key fob	N/A	N/A	●
Charcoal headlining	N/A	N/A	●
R-Design mats, front/rear	N/A	N/A	●
R-Design start-up sequence (digital display)	N/A	N/A	●

● = Standard N/A = Not available

## XC90 OPTIONAL PACKAGES:

## SINGLE OPTIONS:

### VISION PACKAGE

- Blind Spot Information System & Cross Traffic Alert
- 360° Surround View Camera
- Automatically Dimmed Inner & Exterior Mirrors
- Retractable Rear-view Mirrors

### CLIMATE PACKAGE

(R-Design)

- Heated Rear Seats
- Heated Windscreen (NA with Head Up Display)
- Heated Washer Nozzles

### CLIMATE PACKAGE

(Momentum & Inscription)

- Heated Rear Seats
- Heated Steering Wheel
- Heated Windscreen (NA with Head Up Display)
- Heated Washer Nozzles

### CONVENIENCE PACKAGE

- Park Assist Pilot
- Front Park Assist
- Adaptive Cruise Control with Pilot Assist
- Lane Keeping Aid
- HomeLink™
- Compass (Interior Rearview Mirror)
- Grocery Bag Holder
- 12V Power Outlet, Cargo Area

### MOMENTUM PLUS

(Only for T6 Momentum)

- LED Headlights with Active Bending Lights (ABL), Auto Highbeam (AHB) & Thor's Hammer DRL
- Headlight High Pressure Cleaning
- Dark Flame Birch Wood Inlays Illuminated Sill Plates
- Interior High level illumination

	Momentum	Inscription	R-Design
Metallic paint	○	○	○
Dark Flame Birch Wood Inlays	○		
Integrated, Center Booster Cushion, 2nd row	○	○	○
Leather & Flame Birch Wood Steering Wheel	○		
Bowers & Wilkins Premium Sound System w/ CD Player (CD only for T6)	○	○	○
Contour Seats in Nappa Leather	○		
Graphical Head-up Display (HUD)*	○	○	○
4-corner Air suspension with FOUR-C active chassis**	○	○	○
Charcoal Headliner***	○	○	
Carbon Fiber Inlays			○
20" 10-spoke Tinted Silver Alloy Wheels (only for T8)	○		
20" 5-double spoke Alloy Wheels in Matte Tech Black/Diamond Cut (only for T6)	○		
21" 8-spoke Alloy Wheels in Silver Bright Diamond Cut (T6 and T8)		○	
22" 5-double spoke Alloy Wheels in Matte Black Diamond Cut (T6 and T8)			○

○ = Option

\* Deletes heated windshield if Climate Package is ordered

\*\* Requires Convenience Package

\*\*\* N/A with WA00, WC00, UA00, UC00 or UB01



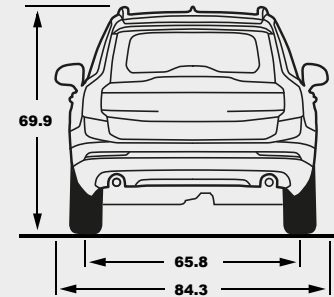
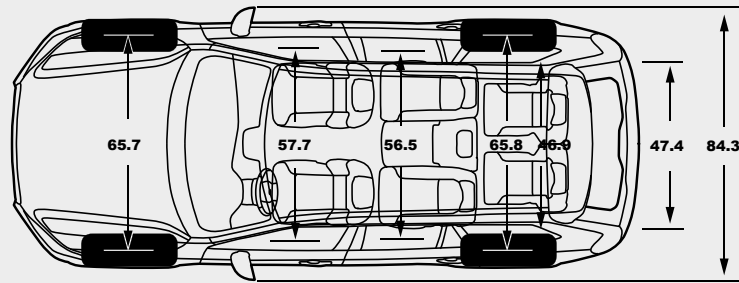
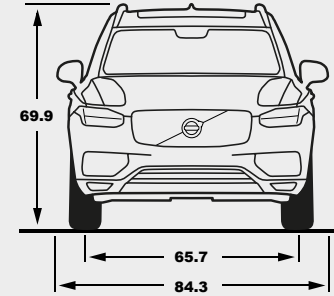
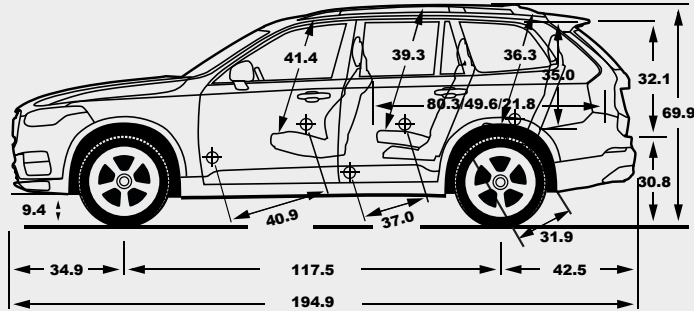

T6 AWD

T8 Twin Engine AWD plug-in hybrid

Engine type	2.0-liter petrol supercharged and turbocharged	2.0-liter petrol supercharged and turbocharged + electric motor
Transmission	Eight-speed Geartronic®	Eight-speed Geartronic®
Fuel consumption (mpg) highway/city	25/20	59 mpg e, city
Max power output (hp)	316	400 (313+87) combined
Max torque (lb/ft)	295	472 (295+177) combined
Fuel tank (gallon)	18.8	13.2
Environmental classification	California LEV III ULEV 125	PZEV

**Please note:** Some of the information in this brochure may be incorrect due to changes in product specifications that may have occurred since printing. Some of the equipment described or shown may now only be available at extra cost. Before ordering, please ask your Volvo Cars dealer for the latest information. The manufacturer reserves the right to make changes at any time and without notice to prices, colors, materials, specifications and models.



# The most carefree way to own a car. Ever.

## LEASING OPTIONS

### FLEXIBLE TERMS

Leasing is available for terms as short as 24 months or up to 48 months. You can drive a new Volvo car every few years while within the manufacturer warranty and maintenance plans and without the burden of negotiating trade-in values.

### CHOICE OF MILEAGE PLANS

The standard mileage option allows up to 15,000 miles per year, however, several other mileage plans are available to tailor to your commuting needs. Under the low mileage plan, options are available as low as 10,000 miles per year and we also offer a high mileage plan with options as high as 30,000 miles per year.

### SINGLE PAYMENT LEASE

A single payment lease provides convenience and savings. You make only one payment, one time, freeing you from monthly payments. It permits you to prepay all monthly payments in a single payment at lease signing. This single total lease payment is less than the amount you would pay over the term of a conventional lease.

### MULTIPLE SECURITY DEPOSIT LEASE\*

A multiple security deposit lease allows you to place a lump sum refundable security deposit at lease inception, which reduces your monthly rent charge resulting in substantial savings over the term of the lease. The additional security deposits are refunded to you at the end of the lease term.

### BUSINESS LEASE

Under our business lease option, owners have the flexibility to lease the vehicle as the business.

### GUARANTEED AUTO PROTECTION (GAP) WAIVER

Our GAP Waiver is included in your lease agreement at no additional cost to you. It is provided to give you peace of mind. If your leased Volvo car is declared a total loss due to theft, accident, or natural disaster, we will cover the difference between the insurance proceeds and the balance owed to Volvo Car Financial Services less any deductible.

### EXCESS WEAR AND USE PROTECTION PLAN\*

As a part of everyday driving, normal wear and use can be expected. However, when turning in your leased vehicle, you may be responsible for any excess wear and use damage, therefore, Volvo Car Financial Services offers an optional plan to protect you and your car from unexpected occurrences that happen from nature and chance.

## FINANCE OPTIONS

Volvo Car Financial Services (VCFS) offers affordable and competitive financing on new and Volvo Certified Pre-Owned cars. Our low rates and flexible terms can get you behind the wheel of the Volvo you want to drive with finance terms up to 75 months. Volvo Car Financial Services also offers financing on vehicles purchased under the Overseas Delivery Program.

\*Please contact your local Volvo car retailer for detailed information on Volvo Car Financial Services Programs. Security Deposit Program is not available in NY. Excess Wear and Use Protection Plan is optional and not available in AK, GA, KS, NM, NY, TX, UT and VT.

## SPECIAL PROGRAMS

### EXPATRIATE PROGRAM

We welcome business professionals from countries outside the United States to finance or lease a Volvo car during their stay in the U.S. Contract length is limited to their length of stay as governed by the applicant's visa and employment contract. Subject to credit approval with Volvo Car Financial Services.

### COLLEGE GRADUATE PROGRAM

You've worked hard to earn your degree. Now the Volvo Graduate Program can make it easy for you to drive a Volvo car. With flexible and competitive financing options available for graduates, Volvo Car Financial Services can help you to step into the luxury of driving a Volvo car with only a 5% down payment upon credit approval.

### VOLVO MOBILITY PROGRAM

The goal of the Volvo Mobility Program is to assist persons with physical disabilities or hearing impairment. For those with exceptional transportation needs, this can be facilitated within the extraordinary comfort and safety of a specially adapted Volvo car. For additional information on this program, please contact **Mobility by Volvo Customer Care** at **(800) 480-9012**.

### PERSONAL SHOPPER

The Volvo Personal Shopper is dedicated to providing you with a whole new level of shopping convenience. Whether you'd like help identifying the Volvo model that best fits your lifestyle, detailed information on any Volvo model, or a comparison against the competition, Volvo is there to help. We can arrange a Guest Drive for you at your nearest Volvo Retailer. So make the most of your shopping time and call the Volvo Personal Shopper at 1-800-550-5658.

## VOLVO OVERSEAS DELIVERY PROGRAM

The Volvo Overseas Delivery Program offers a unique way to buy your new custom-built car as well as a unique way to see more of Europe. When you're done traveling, bring the pleasure of driving a Volvo car back home. Purchase any new Volvo car as part of the Volvo Overseas Delivery Program and enjoy all this, and more:

- Attractive pricing on U.S. models.
- Access to colors and certain features normally only available in Europe.
- 15 days of international insurance and temporary European registration included.
- Two complimentary round-trip tickets to Scandinavia (a peak season surcharge may apply).
- One free hotel night in Gothenburg, Sweden, the home of Volvo Cars.
- An exciting Volvo Cars factory tour or a visit to the new Volvo Brand Experience Center.
- An exclusive VIP delivery experience at the Volvo Cars Factory Delivery Center.
- The opportunity to explore Europe in the comfort and safety of your own Volvo car, either with one of our spectacular tours or on your own.
- Complimentary home shipment services. Just leave your car with us. We'll ship it to you the convenient way while you relax and enjoy your complimentary flight back home.

Can you think of a better way of traveling overseas and making your souvenir part of an unforgettable experience? If you would like to know more, contact your local Volvo car retailer, our Customer Care Center (800) 631-1667, or visit [www.volvocars.us/mybagsarepacked](http://www.volvocars.us/mybagsarepacked) [www.facebook.com/volvooverseasdelivery](https://www.facebook.com/volvooverseasdelivery)

## SERVICE AND WARRANTY

### VOLVO ROADSIDE ASSISTANCE

Whenever you need us, we're just a phone call away. Our nationwide network of retailers and authorized service providers are ready to assist. Whether you require roadside assistance or maps and routing information for your next trip, refer to your Volvo Roadside Assistance card and dial **1-800-63-VOLVO** at any time. Your complimentary four-year membership activates the moment you become a Volvo owner. A connection to Volvo Roadside Assistance can also be made through our free app. Download it for iPhone or Android by typing Volvo Roadside Assistance/US through your app store.

## VOLVO NEW CAR WARRANTY

Your new-car warranty provides comprehensive coverage for four years or 50,000 miles, whichever occurs first. Additional warranties cover corrosion, seat belts, the supplemental restraint system, hybrid components emission systems, genuine Volvo car replacement parts and genuine Volvo accessories. Should you encounter any problem with your Volvo car, simply contact the nearest retailer for assistance. Where your warranty ends, Volvo Increased Protection (VIP) plans begin. To purchase the additional protection of a VIP plan, contact your local retailer.

## COMPLIMENTARY FACTORY SCHEDULED MAINTENANCE

Volvo Cars is committed to a premium ownership experience for its customers. To further enhance your ownership experience, all 2016 model year Volvo cars sold in the United States will include Complimentary Factory Scheduled Maintenance. This program provides scheduled maintenance coverage for the first three years or 36,000 miles, is designed to complement your Volvo warranty, and will help ensure trouble free operation of your Volvo. Coverage includes factory recommended maintenance including oil and filter changes, checks and adjustments as listed in your Warranty and Maintenance Records Information booklet, for the first three maintenance services at intervals of 10,000, 20,000 and 30,000 miles.

Service must be performed within 1,500 miles before or after each scheduled interval. Coverage is limited to scheduled maintenance items listed in the 2016 model year Warranty and Maintenance Records Information booklet. An authorized retailer must perform maintenance. Offer is transferable. Optional Factory Scheduled Maintenance program upgrades are also available that will allow you to customize coverage to meet your driving needs. See your Volvo retailer for details.

## VOLVO SERVICE ADVANTAGE

- Complimentary software updates
- Complimentary vehicle diagnostics
- Alternate transportation
- Personal service contact
- Car wash
- Roadside assistance
- Lifetime replacement parts and labor warranty

For additional information:

[www.volvocars.us/volvoserviceadvantage](http://www.volvocars.us/volvoserviceadvantage)

Momentum



**19"**, 10-spoke Turbine,  
Silver Bright, 172  
(standard T6 Momentum)



**19"**, 6-Spoke,  
Turbine Silver Bright, 177  
(standard T8 Momentum)



**20"**, 5-double spoke,  
Matte Tech Black/Diamond Cut, 234  
(optional T6 Momentum)



**20"**, 10-spoke,  
Tinted Silver/Diamond Cut, 173  
(standard T6 Inscription and optional T8 Momentum)

Inscription

R-Design



**20"**, 10-spoke,  
Tinted Silver/Diamond Cut, 173  
(standard T6 Inscription and optional T8 Momentum)



**21"**, 8-spoke,  
Silver Bright/Diamond Cut, 174  
(optional T6 and T8 Inscription)



**20"**, 5-spoke,  
Matte Black/Diamond Cut  
(standard T6 and T8 R-Design)



**22"**, 6-double spoke,  
Matte Tech Black/Diamond Cut, 175  
(optional T6 and T8 R-Design)

The exterior color you choose has a dramatic impact on the personality of your all-new XC90. Each color imbues the car with a sense of luxury and presence.



**614**  
Ice White



**707**  
Crystal White pearl metallic  
(Also available for R-Design)



**711**  
Bright Silver metallic



**714**  
Osmium Grey metallic  
(Also available for R-Design)



**477**  
Electric Silver pearl metallic  
(R-Design only)



**720**  
Bursting Blue metallic  
(R-Design only)



**467**  
Magic Blue metallic



**700**  
Twilight Bronze metallic



**492**  
Savile Grey metallic



**717**  
Onyx Black metallic  
(Also available for R-Design)



**487**  
Ember Black pearl metallic



**719**  
Luminous Sand metallic



**612**  
Passion Red  
(R-Design only)

**Please note:** It is not possible to reproduce exact original shades in printed matter and on screen. Please ask your Volvo Cars dealer to show you samples.

# V O L V O



MODEL YEAR 2016 | [VOLVOCARS.US](http://VOLVOCARS.US)

Specifications, features, and equipment shown in this catalog are based upon the latest information available at the time of publication. Volvo Cars of North America, LLC reserves the right to make changes at any time, without notice, to colors, specifications, accessories, materials, and models. For additional information, please contact your authorized Volvo Cars retailer. © 2015 Volvo Cars of North America, LLC. Printed in USA on 100% recyclable paper.

MY16A

