

2011 BMW
7 Series Sedan



The Ultimate
Driving Machine®



THE BMW 7 SERIES.

JOY COMES TO THOSE WHO NEVER STAND STILL.

BMW EfficientDynamics 
Less emissions. More driving pleasure.



78 1988 1995 2002 2009

The introduction of each successive BMW 7 Series generation opens a new chapter in automobile design, performance, technology, comfort and luxury. Not just for BMW, but for the automotive world at large. Now BMW introduces its highest benchmark, the 7 Series for 2011 – proof positive that the 7 Series never stands still.

The 2011 BMW 7 Series

02 | 05 Introduction

Driving experience

06 | 15 Exterior

16 | 19 Interior

20 | 25 Exterior long-wheelbase version

26 | 29 Interior long-wheelbase version

Technology

30 | 31 Introduction

32 | 33 BMW EfficientDynamics

34 | 35 Engines

36 | 39 BMW ActiveHybrid 7

40 | 41 Driving Dynamics Control | xDrive

42 | 43 Integral Active Steering | Chassis

44 | 45 BMW ConnectedDrive

46 | 47 Driver Assistance

48 | 49 Headlights | BMW Night Vision | Head-up Display

50 | 51 Safety

Equipment

52 | 55 Paints | Upholsteries | Interior trims | Combinations

56 | 57 Selection examples

58 | 69 Standard | Optional equipment

70 | 71 BMW 760Li

72 | 73 BMW Individual | BMW Accessories



74 | 75 Standard safety features and technology illustrations

76 | 83 Standard | Optional equipment charts

84 | 85 Technical data

Services

86 | 87 BMW Services

	BMW 750i shown with the following equipment:
BMW 750i	Engine: 32-valve, TwinPower Turbo 4.4-liter V-8 Wheels: Light alloy Radial Spoke (Style 252) Exterior color: Dark Graphite Metallic Upholstery: Saddle Brown and Black Nappa Leather Interior trim: Fine Line High-Gloss Wood
	BMW 750Li xDrive shown with the following equipment:
BMW 750Li xDrive	Engine: 32-valve, TwinPower Turbo 4.4-liter V-8 Wheels: Light alloy Multi Spoke (Style 235) Exterior color: Cashmere Silver Metallic Upholstery: Oyster Nappa Leather Interior trim: Ash Grain Wood

For details on paint, upholstery and interior trims, please refer to pages 52-55.



NINE MODELS, ONE BENCHMARK: THE BMW 7 SERIES.



Merging time-honored design values with forward-looking ideas, the BMW 7 Series is instantly recognizable. Its sweeping profile with set-back passenger cabin reveals artful, sculpted details with every glance, while conveying its confident, muscular power. In front, the signature twin-kidney grille is rendered higher and wider, channeling more air to BMW's powerful engines so they can breathe more deeply. Distinctive Corona headlight-rings in the familiar four-headlight BMW visage serve as Daytime Running Lights. A unique roofline and longer rear doors distinguish the long-wheelbase models, hinting at the greater room to stretch out in the rear cabin.

BMW EFFICIENT DYNAMICS: ENSURING A LONG FUTURE OF DRIVING PLEASURE.

Steered by the principles of EfficientDynamics, BMW launches a new era in driving performance. BMW's commitment to EfficientDynamics means creating more power without increasing fuel consumption and emissions. It means greater structural integrity while using lighter materials. Most important, it means delivering on the promise of "The Ultimate Driving Machine®" while respecting today's resources – and tomorrow's.





FUELED BY A PASSION FOR DRIVING – AND PREPARED FOR WHAT LIES AHEAD.

The superb suspension system and Driving Dynamics Control give the BMW 7 Series a voracious appetite for the road. At the same time, it's prepared to handle the types of driving conditions that can reduce not only comfort but alertness, fatiguing the driver. At highway speeds, in traffic jams or toll lanes, Active Cruise Control with Stop & Go automatically maintains your preset speed and distance to the vehicle ahead, alternately braking and proceeding as needed.¹ And the Navigation system provides Real Time Traffic Information, helping you to avoid stressful driving conditions in the first place.

¹ Active Cruise Control is not a substitute for the driver's own responsibility in adjusting speed and otherwise controlling the vehicle. After evaluating road, traffic and visibility conditions, the driver must decide whether and how the system is used.

For details on the availability of standard and optional features, please refer to the **Standard equipment** | **Optional equipment** charts at the back of this brochure.



**BMW GIVES YOU THE TECHNOLOGY TO SEE
WHAT YOUR EYES ALONE CANNOT.**

In addition to its proven active and passive safety features, the 7 Series offers a host of innovative driver-assistance technologies designed to help you avoid hazardous situations – especially those you might not be able to see on your own. Active Blind Spot Detection uses

radar sensors at the rear of the vehicle to monitor traffic in adjacent lanes and warns if there is a vehicle in your blind spot. BMW Night Vision with Pedestrian Detection helps you spot people walking along or crossing dark roads up to approximately 300 feet ahead.

For details on the availability of standard and optional features, please refer to the **Standard equipment** | **Optional equipment** charts at the back of this brochure.





A COCKPIT TO MAKE A PRIVATE JET PILOT ENVIIOUS.

An instrument panel that comes to life from behind a Black Panel Display is the first sign of the 7 Series' remarkable blend of advanced technology and innovative luxury. In true BMW fashion, controls are driver-oriented and easy to reach. Driving controls are to the left, comfort controls are to the right, and using them becomes second nature. The Head-up Display projects vehicle speed and driving information on the windshield, directly in the driver's line of sight. BMW's redesigned iDrive Controller is more intuitive than ever to use, and presents more options at eye level on a 10.2-inch LCD screen. It includes eight programmable memory buttons that let you store your most frequently accessed functions. And, like iDrive, the standard Navigation and audio systems also respond to your voice commands.

For details on the availability of standard and optional features, please refer to the **Standard equipment** | **Optional equipment** charts at the back of this brochure.



THE BEST SEATS IN THE HOUSE AREN'T NECESSARILY IN THE HOUSE.

As thoroughly as the BMW 7 Series caters to its driver, it also takes first-class care of its passengers. After the soft-closing of the automatic doors, those riding in the rear compartment enjoy room to stretch out in comfortable seats upholstered in soft Nappa Leather, and bathed in the warm nighttime glow of Ambiance lighting. Two separate, rear climate controls allow individualized temperature zones. The miles, minutes and hours of the journey will melt away when there's a Rear Entertainment Package that keeps both passengers riveted to individual 8-inch color screens built into the front-seat backrests. And glare is never a problem with the power rear window and rear side window sunshades that ensure privacy while helping to keep the cabin cool.

European screens shown.

For details on the availability of standard and optional features, please refer to the **Standard equipment** | **Optional equipment** charts at the back of this brochure.

PROFILES IN LUXURY.

From any angle, at any distance, the BMW 7 Series conveys its powerful presence. Understated yet strong character lines shape the hood's "powerdome," then flow down to frame the classic twin-kidney grille. The longest wheelbase in its class sets a foundation for the sleek profile of the 740Li, 750Li and 760Li,¹ while yielding truly spacious accommodations inside. Even with a longer roof and rear doors, each still retains a coupe-like profile, while the positioning of the passenger compartment and short overhangs preserve the classic BMW proportions. A strong shoulder line continues uninterrupted across the deep-seated door handles, underscoring the level of craftsmanship. Together with a pronounced, sporty rocker panel that is quite bold for a luxury sedan, the 7 Series' sleekness is accentuated, suggesting motion even when parked.

¹ Model Year 2011 760Li available September 2010.



TAILORED TO MEET THE HIGHEST STANDARDS. YOURS.

An architect-designed home. A handmade suit. Custom-fit golf clubs. True luxury caters to the individual who chooses it. So why not the way your car feels and drives, too? BMW engineers answered that question with Driving Dynamics Control. With the push of a button, you can give your 7 Series Sedan one of four distinct personalities, from comfortable cruiser to track-inspired performer. The Dynamic Damping Control feature, in turn, adapts shock-absorber settings to road conditions – and your mood – at any given moment, for the optimal level of firmness. Even in the world's finest luxury sedans, allowing you to choose your levels of comfort and performance is, truly, a luxury.





STRETCHING THE POSSIBILITIES FOR PASSENGER COMFORT.

With the longest wheelbase in their class and a wide array of luxury features, the Li models are as much a pleasure for rear-seat passengers as they are for the driver. BMW added 5.5 inches to the wheelbase of the standard-length 7 Series to yield even more rear legroom – and, thanks to a unique roofline, more headroom. Your passengers will be totally pampered with the Luxury Rear Seating Package. Two power-adjustable rear Comfort seats coddle occupants with four-way power lumbar support, adjustable cushion and backrest angles, and automatic head-restraint height. At their fingertips: controls for seat heating and ventilation, where internal fans gently direct cooling or warming air through the soft, perforated leather for exceptional all-season comfort. The massaging rear-seat feature, with its 12 air chambers relaxes the back muscles through wave-like movements from top to bottom, while six rotating elements work the back from the shoulders to the lumbar region. It's almost enough to make a driver jealous.

For details on the availability of standard and optional features, please refer to the **Standard equipment** | **Optional equipment** charts at the back of this brochure.







**AT BMW, WE DON'T STOP TO MEASURE OUR SUCCESSES.
WE CONTINUALLY SURPASS THEM.**

BMW has achieved many notable milestones in automotive engineering and design, but it views even these as temporary benchmarks. That's why every generation of 7 Series continues to introduce new ideas, technologies and safety features that raise the bar worldwide for driving enjoyment. Past 7 Series generations debuted the Digital Motor Electronics (DME) system and the industry's first drive-by-wire electronic throttle control; both helped to match performance gains with improved efficiency and reduced emissions. Earlier models also introduced daylight-

like Xenon high-intensity discharge (HID) headlights; Dynamic Stability Control (DSC), a proven life-saving system that helps maintain control the instant over- or understeer is detected; the multi-function steering wheel; the on-board GPS-based Navigation system and many other breakthrough technologies. In all – and for all to follow – the 7 Series has created a framework for combining scintillating performance with tantalizing luxury, enhanced margins of safety, and ever greater efficiency.

THIS IS HOW MUCH HAS GONE IN.

At BMW, we create dynamic vehicles that thrill you with quick acceleration, predictable handling and unshakable control. We are also busy finding innovative fuels and technologies that help preserve the environment while delivering legendary performance. This is what we refer to as “EfficientDynamics.” This goal led to the visionary CleanEnergy hydrogen-powered engine in the BMW Hydrogen 7 Sedan. In 2009, BMW introduced Advanced Diesel with BluePerformance in the U.S., offering diesel power with quick acceleration, increased fuel efficiency and reduced emissions. And now, BMW’s ActiveHybrid X6 and ActiveHybrid 7 vehicles combine combustion and electric power along with Brake Energy Regeneration to boost performance while simultaneously reducing fuel consumption and CO₂ emissions. At BMW, we are driven to do much more with less.

High Precision Direct Injection

Turbocharging is traditionally known for boosting power at the expense of fuel efficiency. BMW TwinPower Turbo engines with direct fuel injection, however, inject gasoline at high pressure and with extreme precision into each cylinder. And, thanks to BMW’s fast and flexible electronic control system, both the timing and quantity of the fuel injections can be precisely adjusted to driving conditions. As a result, BMW vehicles achieve greater power with excellent fuel efficiency.

Aerodynamics

The more smoothly that air flows over a vehicle, the more efficiently it can operate. All BMWs are designed for a low coefficient of aerodynamic drag, which translates into quicker acceleration, more stable handling, quieter operation and greater fuel efficiency. A BMW’s integrated front spoilers reduce the amount of air flowing underneath, minimizing front-end lift. This allows a BMW to hug the road at higher speeds for excellent stability.



Double-VANOS

VANOS is BMW’s valve timing system that can “steplessly” vary the points in the combustion cycle when valves open and close. Double-VANOS refers to the fact that it operates on both the intake and exhaust camshafts. Electronically controlled in response to engine speed, load and temperature, VANOS reduces emissions, and enhances low- to medium-speed torque, as well as fuel efficiency.

TwinPower Turbo engine

Benefiting from BMW’s TwinPower Turbo technology, the 7 Series’ engine delivers quick acceleration while virtually eliminating turbo lag.

Lightweight construction

Our engineers use lightweight aluminum throughout our vehicles – in the front section, for example, or for the suspension. BMW’s V-8 TwinPower Turbo engine’s crankcase, as well as the roof, hood, doors and fenders, are all made of aluminum. Taken together, these weight savings lead to lower fuel consumption and better axle load distribution for more agility – especially in curves.

AND THIS IS WHAT COMES OUT.

BMW models have low CO₂ emissions today. But that’s just for starters. We’re carrying on our research in the quest to bring you greater driving pleasure, with fewer emissions and decreased fuel consumption.

BMW EfficientDynamics 
Less emissions. More driving pleasure.

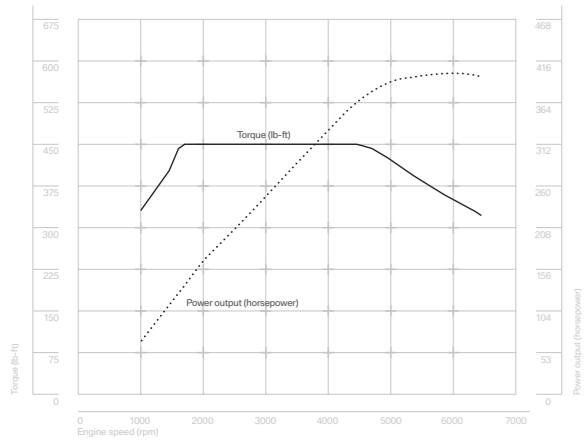

With its TwinPower Turbo technology and precision fuel injection, BMW's 4.4-liter V-8 engine develops breathtaking torque and power. Its potent acceleration in any rev range delivers an unforgettable driving experience.

ENGINES THAT DESERVE TO BE CALLED "POWERPLANTS."

From the moment you push the Start button, you know that no drive will ever be ordinary. All 7 Series models are driven by TwinPower Turbo technology, which delivers immediate, potent thrust while helping to eliminate "turbo lag." In line with BMW EfficientDynamics technology, High Precision Direct Injection delivers precise amounts of fuel into the combustion chamber at very high pressure, enhancing efficiency and unleashing even greater power.

The new 740i and 740Li rely on BMW's acclaimed inline six-cylinder TwinPower Turbo engine. Rated 315 hp with 330 lb-ft of torque, it propels the 740i from stop to 60 in 5.8 seconds,¹ with remarkable efficiency for a luxury performance sedan.

The 750i, 750Li, 750i xDrive and 750Li xDrive are all equipped with a 4.4-liter TwinPower Turbo V-8. Its robust 400 hp accelerates the all-wheel-drive 750i xDrive smoothly from 0 to 60 mph in 5.0 seconds,² while the boost from 450 lb-ft of peak torque is sustained from 1750 all the way to 4500 rpm.

The 760Li³ gets its furious muscle from BMW's formidable 535-hp TwinPower Turbo V-12. Press the accelerator pedal and the speedometer will read 60 mph in just 4.5 seconds.⁴ This power source whips up 550 lb-ft of torque from 1500 to 5000 rpm, yet it is remarkably quiet and free of vibrations.

A 6-speed automatic transmission is standard in the 740i/740Li, 750i/750Li and 750i/750Li xDrive models; the 760Li's V-12 has been matched with BMW's 8-speed automatic. A console-mounted E-Shift control offers both Manual and Automatic modes. In Manual mode, tip the lever forward for downshifts, rearward for upshifts. In any mode, you will enjoy quick, smooth shifting.

¹ BMW AG test results, 740i – 5.8 seconds, 740Li – 5.9 seconds. BMW urges you to obey all posted speed laws and always wear safety belts.

² BMW AG test results, 750i – 5.1 seconds, 750Li – 5.2 seconds, 750Li xDrive – 5.1 seconds.

BMW urges you to obey all posted speed laws and always wear safety belts.

³ Model Year 2011 760Li available September 2010.

⁴ BMW AG test results. BMW urges you to obey all posted speed laws and always wear safety belts.

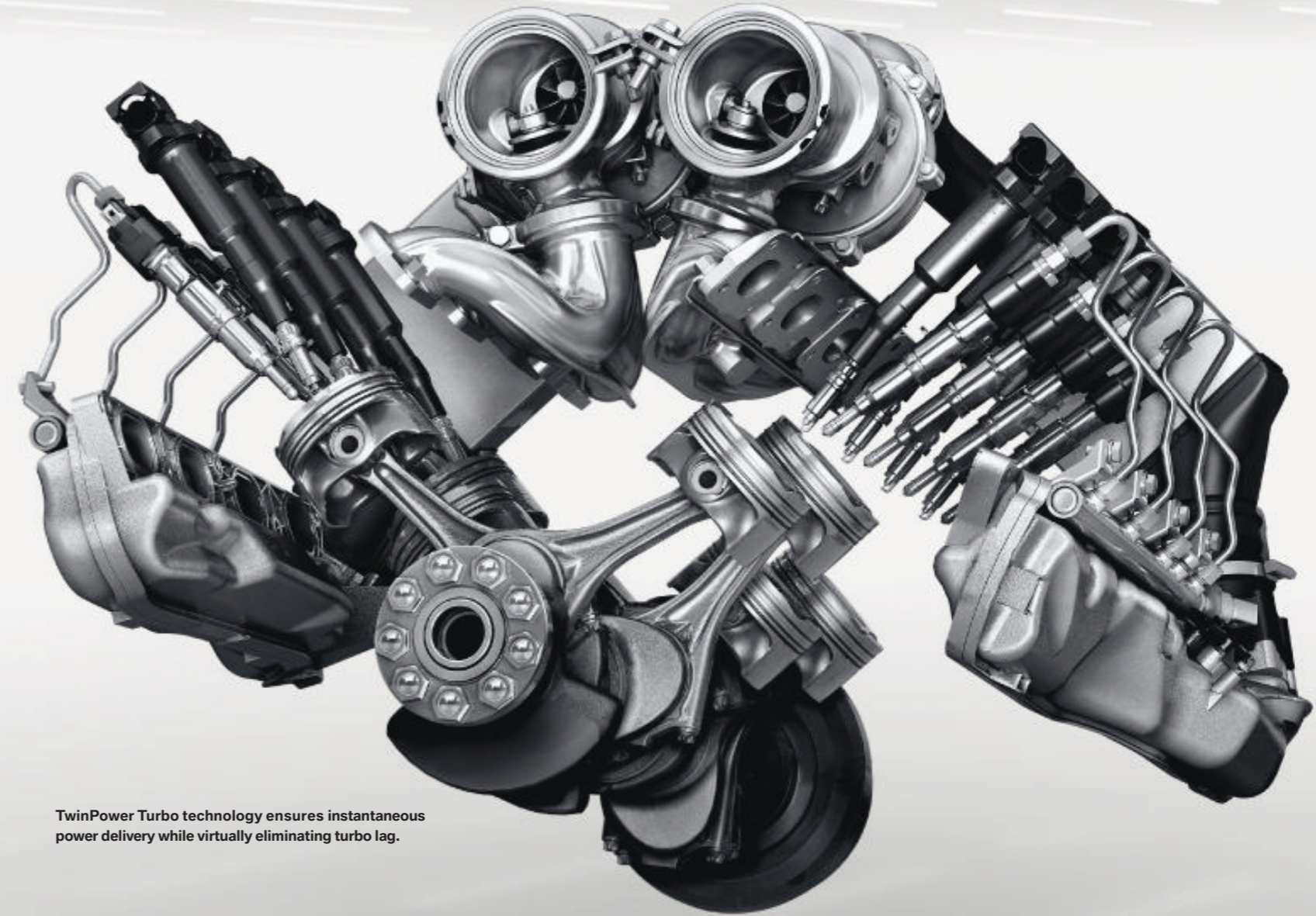

TwinPower Turbo technology ensures instantaneous power delivery while virtually eliminating turbo lag.



THE MOST DYNAMIC WAY TO DRIVE A HYBRID.

Forget everything you previously thought about hybrids: that they are slow, unexciting vehicles that sacrifice performance, space and luxury in the name of frugality. The BMW ActiveHybrid 7 blends all the outstanding attributes of the 7 Series with greatly enhanced efficiency. In fact, the BMW ActiveHybrid 7 is the world's fastest hybrid vehicle, rocketing smoothly from 0 to 60 mph in an incredible 4.7 seconds,¹ while realizing up to 15 percent greater fuel economy than the non-hybrid 7 Series. This "mild" hybrid gets its power from two closely interlinked drive units that permanently work together. BMW's TwinPower Turbo V-8 combustion engine – the main drive source – puts maximum torque at your command, even at low engine speeds. It's linked to an electric motor with a storage battery, which generates a V-12-worthy power boost for blistering acceleration. The ActiveHybrid 7 is also designed to minimize the weight and space requirements of the normally bulky hybrid components. True to the philosophy of EfficientDynamics, BMW uses innovative technology to combine maximum driving pleasure with the lowest possible fuel consumption and emissions.

¹BMW AG test results. ActiveHybrid 750i; ActiveHybrid 750Li – 4.8 seconds.





The cool, elegant Blue Water Metallic paint is exclusive to the BMW ActiveHybrid 7. The same applies to the striking 19-inch Double Spoke (Style 357) light alloy wheels.

YOU KNOW WHAT A HYBRID IS. YOU NEED TO KNOW WHAT BMW MAKES OF IT.

In the BMW ActiveHybrid 7, the combustion engine and electric motor work closely together. Depending upon the situation – maintaining current speed, generating electricity to run various features, or providing bursts of power needed for quick acceleration – one unit backs up the other to an optimal degree. This serves to enhance the efficient performance of BMW's TwinPower Turbo V-8 engine, generating V-12 performance with six-cylinder fuel economy. Among other factors, the low overall weight of the system makes the BMW ActiveHybrid 7 the front-runner among hybrids when it comes to acceleration.



Special welcome: an exclusive chrome door-sill finisher design.



As soon as you brake or lift your foot off the throttle, Brake Energy Regeneration converts the braking energy released by the vehicle into electric power, and feeds it into the battery. The charge process is displayed by a symbol in the tachometer.



A clear graphic in the iDrive Control Display shows the source of power flow in real time. Electric power is shown in blue; power from the combustion engine is indicated in red.



A bar chart indicates driving efficiency. The display shows the previous 15 minutes and is updated every 60 seconds. You can monitor the energy efficiency of your driving style based on the height of the bars: the higher the bar, the more efficient your driving.

Electric air conditioning compressor: The electric drive of the air conditioning system is independent of the combustion engine. You can create a comfortable climate inside the cabin at any time – even when parked with the engine switched off. This frees available hybrid power for use by the engine, and allows unrestricted running of hybrid functions – even during sporty driving maneuvers and in extreme weather.

Hybrid management: This controls performance as well as energy generation and release, for improved driving feel and reduced fuel consumption.

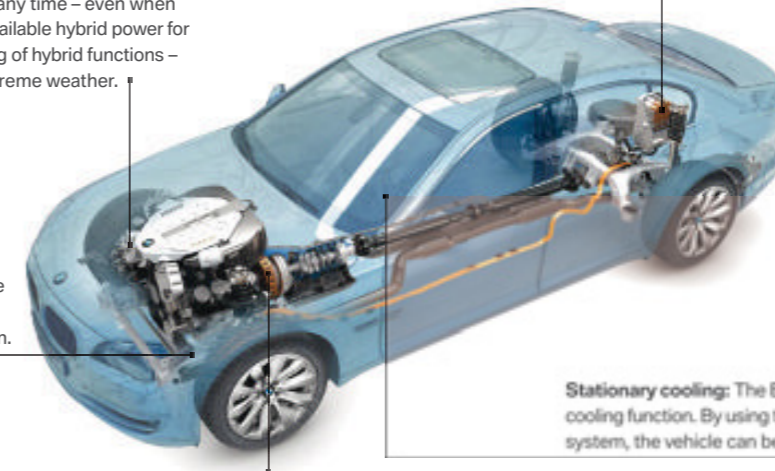

Battery: The compact, high-performance 120-volt lithium-ion battery is ideal for everyday use. It's designed to take up minimal space.

Stationary cooling: The BMW ActiveHybrid 7 features a unique stationary cooling function. By using the remote control to activate the air conditioning system, the vehicle can be cooled even before you get inside.

Electric motor: This takes over the start-up function and backs up the combustion engine during acceleration, for a much more intense driving experience. At the same time, the electric motor helps reduce emissions and fuel consumption while it acts as a generator during Brake Energy Regeneration.



AN IDEAL BALANCE: DYNAMIC HANDLING AND A COMFORTABLE RIDE.

BMW engineers are not magicians, but they do have a way of transforming inert materials into vehicles that come alive on the road as no others do. It starts with the 7 Series' aluminum suspension components that reduce unsprung weight. You feel the benefit in the way the 7 Series so adroitly tames curves and absorbs bumps.

But no two curves, bumps or dips in the road are alike. That's why, with Dynamic Damping Control, the 7 Series responds to each individually. Controlled by a super-fast computer, Dynamic Damping Control adjusts suspension damping – the shock absorbers – nearly instantaneously.



Driving Dynamics Control: With just the push of a button on the console, standard Driving Dynamics Control lets you give the 7 Series a handling and performance attitude adjustment. Choose from four settings – COMFORT, NORMAL, SPORT and SPORT+ – to adjust shock-absorber firmness, transmission shift characteristics, engine-throttle response and power-steering assist. In addition, the traction control feature (at top) can be disengaged when driving on sand, gravel, or deep or packed snow.

As you drive, sensors “read” the road and convey data to the control unit every 2.5 milliseconds. That's 400 times per second, or about 150 times quicker than the blink of an eye. Suspension adjustments occur far too quickly for you to feel them; what you do feel is the result. When Dynamic Damping Control is combined with Active Roll Stabilization and Integral Active Steering – it gives the 7 Series an uncannily smooth ride and sports-car-like agility, without compromise. The best part? You select the way the 7 Series responds via the Driving Dynamics Control button on the console. So no matter what the road may look like, it feels like it was paved just for you.

For details on the availability of standard and optional features, please refer to the **Standard equipment** | **Optional equipment** charts at the back of this brochure.

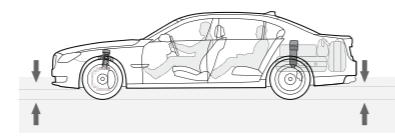

Dynamic Damping Control: This system automatically adjusts shock-absorber settings between softest and firmest, adapting to road conditions, vehicle speed and combined passenger/cargo weight. On smooth roads, shock absorbers are kept at the softest appropriate setting. On uneven road surfaces or when cornering, they are made firmer to maximize ride comfort and road-grip.

xDRIVE TAKES YOU WHERE YOU WANT TO GO. WHATEVER HAPPENS TO CROSS YOUR PATH.

A sudden downpour, mud on the road, leaves or snow: situations that normally make driving challenging. In difficult weather conditions, or on challenging road surfaces, BMW's xDrive intelligent all-wheel-drive system takes all-road traction to new heights, while maintaining the 7 Series' legendary agility. On smooth, dry roads, the 7 Series xDrive models have the feel of their rear-wheel-drive counterparts. But hit a wet uphill curve, for instance, and even before wheelspin can occur, the xDrive all-wheel-drive system immediately recognizes any need for a change in power distribution. Almost instantaneously, xDrive can send more torque to the front axle in order to achieve optimal stability. Should one wheel on an axle spin faster than the other, the brakes automatically engage, as needed, to bring all wheels back in sync. At any given moment, xDrive is working hard, shifting drive power, reducing over- or understeer, enhancing agility, and providing the best possible traction.

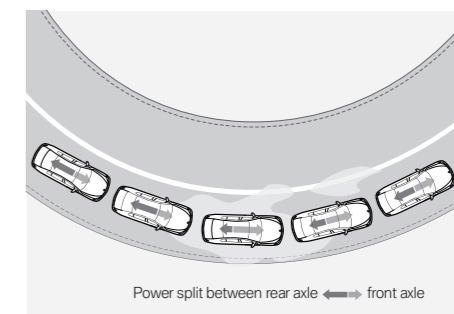

xDrive intelligent all-wheel-drive system uses readings from the gas pedal and Dynamic Stability Control (DSC) sensors to monitor the 7 Series xDrive's driving condition. This data is then used to vary power distribution between the front and rear axles for agile, neutral and forgiving handling.



INTEGRAL ACTIVE STEERING: ENJOY GREATER AGILITY AND STABILITY.

Only BMW could make a luxury sedan feel so agile. Integral Active Steering adds speed-sensitive rear-wheel steering to BMW's Active Steering system. As before with Active Steering, a small turn of the steering wheel at low speeds yields a greater turn of the front wheels for more direct response; now it also steers the rear wheels up to three degrees in the opposite direction, enhancing maneuverability. Changing lanes at highway speeds, the rear wheels turn in the same direction as the front wheels, for unrivaled handling and stability. Your passengers enjoy greater ride comfort from reduced body roll, while you experience extraordinary responsiveness.

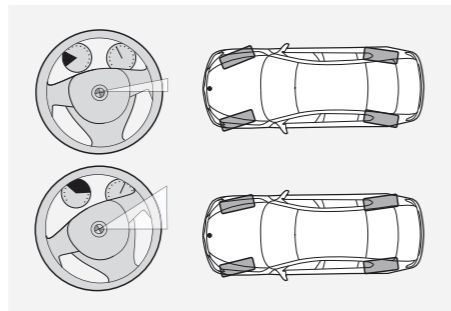

Integral Active Steering: Left, top: at speeds of up to 35 mph, the rear wheels steer in the opposite direction to the front wheels. At the same time, Active Steering boosts the effect of steering wheel input on turning the front wheels, for sharper cornering. Left, below: at 50 mph and above, the rear wheels steer in the same direction as the front wheels. This enhances both straight-line driving and directional stability.

THE CHASSIS OF THE BMW 7 SERIES. OUR ENGINEERS' MASTERPIECE.

Innovative technologies on many fronts aid in the quest for superior agility and smoother ride comfort. Achieving an ideal balance of the two is a BMW hallmark. The 7 Series has long set the benchmark in its class for balancing dynamic handling and a comfortable ride – but that has never stopped BMW from always setting higher standards.

One area for optimizing this balance is high-strength construction using lightweight materials. High-tensile steel is employed extensively in the load-bearing structure. Lightweight aluminum is used in the roof, doors, hood and front fenders, as well as in both the multi-link double-wishbone front suspension and Integral-V multi-link rear suspension. This use of lightweight aluminum offsets engine weight on the front axle, helping to maintain a near-perfect 50/50

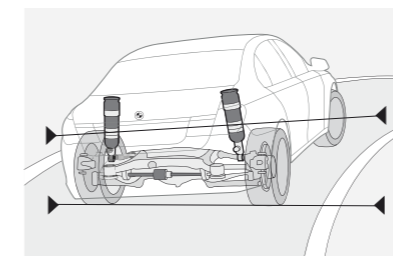

Quick cornering without Active Roll Stabilization:

When cornering at higher speeds, physics dictates that a vehicle's body has a tendency to roll.

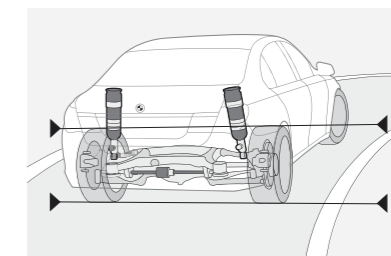

Quick cornering with Active Roll Stabilization:

This feature, included in the Sport Package, allows sportier driving maneuvers. Stabilizers reduce body movement, improving both dynamics and comfort levels.

For details on the availability of standard and optional features, please refer to the **Standard equipment** | **Optional equipment** charts at the back of this brochure.

STAY TOTALLY IN TOUCH WHEREVER YOU GO – WITH BMW CONNECTED DRIVE.

Whether you're far from home or just in the next town, BMW Assist™ offers convenience and peace of mind. There are new ConnectedDrive features that extend BMW's leadership in wireless communications. Marvel at an extensive array of new Mobile Office functions. Get a visual image of your callers. With BMW Assist, you enjoy all this – and more.



With **BMW Assist Safety Plan**, a response specialist is there to help you 24/7 at the touch of a button. Enjoy these services for four years at no additional charge: Automatic Collision Notification, Emergency Request (SOS), TeleService, Enhanced Roadside Assistance, Door Unlock, Stolen Vehicle Recovery, MyInfo and Customer Relations. The **Convenience Plan** adds personalized Directions, Traffic and Weather reports, BMW Search, and Concierge services for restaurant and hotel recommendations, with the destination address and phone number sent to your BMW. Make up to four operator-assisted calls per year with Critical Calling if your mobile phone is not available or if its battery is discharged.



An automotive first: BMW's amazing new **Mobile Office** feature goes way beyond phone calls when it comes to staying in touch. When your compatible Bluetooth® phone is paired with your BMW, text messages and emails are transferred to your BMW's iDrive display screen – and then our system even reads them aloud to you.

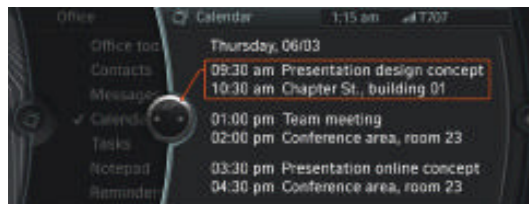

What's on today's agenda? Bring up the **Calendar** and **To-do List** on your display screen while en route, to help you stay on schedule. Need to call your 11 o'clock appointment? Use the iDrive Controller knob to **click on the phone number** in the Calendar – and it's ringing. Meeting with several people? Conduct conference calls; the display screen keeps you informed of the status of incoming calls. Who's ringing you? If you've uploaded photos to your on-board phonebook, you'll see the caller's picture. Even missed calls are listed on the display screen. It's never been easier to stay in touch while in transit.



Enhanced functions for the iPod® and USB adapter add to the ease and pleasure of using your iPod or iPhone.® Want to know which CD that song comes from? The album cover is shown on your display screen. Don't purchase additional cables – your iPod or iPhone's original USB cable connects to your BMW's USB port. Another rare feature: with Bluetooth audio streaming, now you can wirelessly play music through the BMW audio system from any Bluetooth compatible music player or mobile phone, from anywhere in your vehicle. In fact, the audio library appears on the display screen, where you can use the iDrive Controller knob to make your selection.

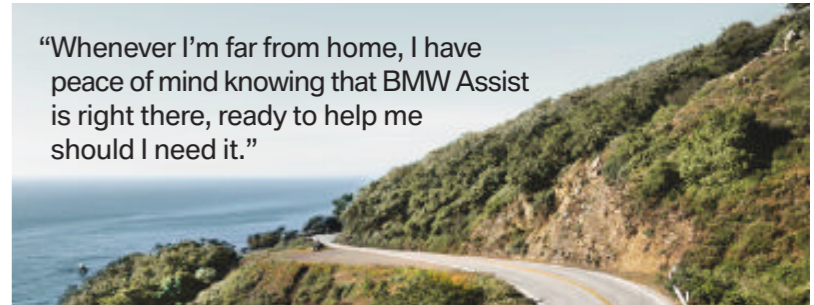

“Whenever I’m far from home, I have peace of mind knowing that BMW Assist is right there, ready to help me should I need it.”

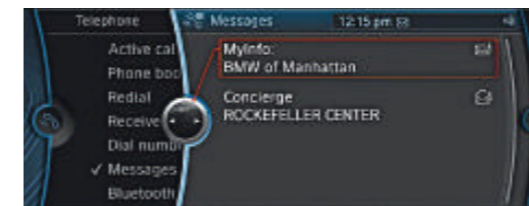

MyInfo allows you to send business locations and street addresses to your BMW from Google Maps.™ Destinations and phone numbers can be accessed and exported to your Navigation system for immediate route guidance, while you can call the destination with your Bluetooth linked phone.

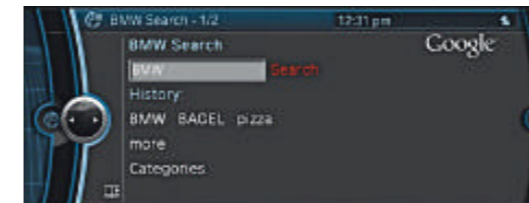

BMW Search allows online access to up-to-date fuel prices and gas station locations; the latest weather forecasts, advisories and warnings; Dow Jones, S&P 500 and NASDAQ indices; and the powerful reach of the Google Maps database – all delivered on the control display inside your vehicle. Access news headlines and have them read aloud via text-to-speech technology. “Send to Mail” pinpoints your current location and planned destination, and allows you to send it to any smartphone or email account. Then it's just a quick hyperlink to Google Maps for your friends and family to see where you are and where you're going.

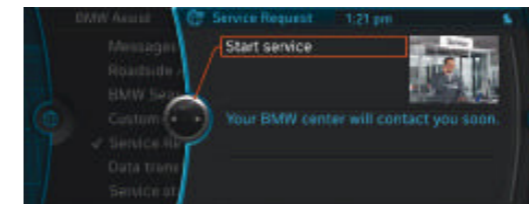

BMW TeleService monitors the status of many of your vehicle's fluids and parts that are subject to wear and tear, and automatically transmits the data to your BMW center before it requires service. Your BMW center will contact you to schedule a convenient appointment. Needed parts will be ordered, so your BMW will be serviced and returned to you as quickly as possible.



Want to know the location of a challenging golf course or a fine French restaurant? Talk to our **Concierge** and get the address and phone number of your desired destination sent to your BMW Navigation system and then start route guidance at the push of a button.

For details on the availability of standard and optional features, please refer to the Standard Equipment | Optional Equipment charts at the back of this brochure.



The **Lane Departure Warning** feature, included in the Driver Assistance Package, uses a camera near the rear-view mirror to monitor road lane markings.¹ If you begin to change lanes without first using the turn signal – a possible indicator of drowsiness – the steering wheel discreetly vibrates as a reminder.

¹ Requires clearly definable lane markings that are not obscured by rain, snow, etc. Lane Departure Warning feature is not a substitute for the driver's own responsibility in maintaining safe control of the vehicle.

AT BMW, WE KNOW THE VALUE OF 20/20 REAR VISION, TOO.

Before you can take advantage of a BMW's razor-sharp handling, you need to know what's around you. The 7 Series offers ingenious features to help you keep track of what's behind and to the side of your vehicle.

Active Blind Spot Detection, included in the Driver Assistance Package, uses radar sensors at the rear to monitor traffic in adjacent lanes, covering an area from the driver's blind spot rearward for nearly 200 feet. If there is a vehicle in this critical area, an illuminated triangular warning LED appears in the side-view mirror. If you activate the turn signal when there is another vehicle in the lane, the LED blinks and the steering wheel vibrates as a warning not to change lanes.

Park Distance Control, BMW's ultrasonic-based parking-assist system, uses audible alert tones if you get too close to an obstacle that's behind or in front of you.

The **Rear-view Camera** shows, on the Control Display, the area behind the vehicle. With Park Distance Control, interactive guidelines show if the vehicle will fit into a parking space, and display parking trajectories and turn angles.

For details on the availability of standard and optional features, please refer to the **Standard equipment** | **Optional equipment** charts at the back of this brochure.



The **Night Vision with Pedestrian Detection** feature identifies people and determines their position and distance from the car. Depending on the vehicle's speed, a warning is triggered, if necessary.

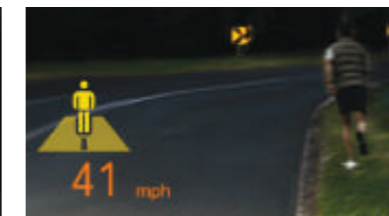

When Night Vision is combined with the **Head-up Display**, the pedestrian warning is also projected directly into the driver's field of vision. The warning is activated when the car is approximately 300 feet from the pedestrian.

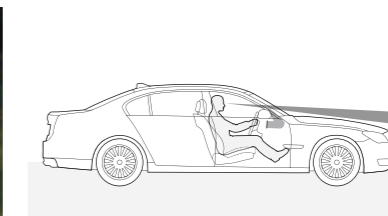

The Head-up Display shows important driving information directly in front of the driver, so concentration remains focused on the road. This increases driver comfort and the safety margin for other road users.



The driver selects the information to be shown on the Head-up Display, such as vehicle speed. It can also display Navigation system arrows, Check Control information, and alerts from the Lane Departure Warning system.

THE BMW 7 SERIES: THE ABILITY TO SEE – AND BE SEEN.

The headlight clusters in the 7 Series are strikingly designed, with BMW's signature double lights under a frosted "eyelid." But the true brilliance of these sculptural forms is in their function. Distinctive Corona headlight-rings that circle all four lamps act as parking lights and, if desired, as Daytime Running Lights. At night, Xenon Adaptive Headlights provide extremely bright, broad illumination; an auto-leveling feature helps keep glare out of the eyes of oncoming drivers. What's around the bend on dark roads? As soon as you begin to round a corner, Adaptive Headlights show you.

Using data from on-board sensors and the steering wheel angle to determine the vehicle's direction, the feature automatically swivels the lights up to 15 degrees, following the curves of the road. Cornering Lights illuminate the side of the road up to 90 degrees when you make a turn. And don't worry about turning high beams on and off: Automatic high beams, automatically do that for you, as needed – so you can enjoy the road ahead.

For details on the availability of standard and optional features, please refer to the **Standard equipment** | **Optional equipment** charts at the back of this brochure.

Night Vision with Pedestrian Detection. Pedestrians are often difficult to see at night. BMW's Night Vision with Pedestrian Detection features an infrared camera in the front bumper that can scan up to 900 feet ahead.¹ It detects people as well as the direction of their movement up to approximately 300 feet away, and displays their presence on the iDrive screen and Head-up Display (if so equipped). The system gives a visual warning as soon as the pedestrians move towards the road, alerting you to potential dangers significantly earlier, so you can react more quickly.

Head-up Display. BMW instrumentation is designed to give you important driving information at a glance. Taking this convenience one step further, BMW offers the Head-up Display, which projects important travel data onto the windshield. It lets you concentrate on the road while staying informed of everything – your speed, Navigation system arrows, Check Control warnings and more. You can also adjust the display for brightness, or turn it off.

¹ Under optimal road conditions. Night Vision performance is also limited by rain, fog, humidity and other weather conditions.



BMW BRAKES PLUS DYNAMIC STABILITY CONTROL: A MASTERFUL BLEND OF BRAWN AND BRAIN.

The road is not always smooth, straight or dry. That is why BMW has long been an innovator of “active safety” features – powerful engines; massive, fade-resistant anti-lock brakes; agile handling and balanced performance – to help you avoid potentially dangerous situations.

A core component of BMW’s active safety systems is Dynamic Stability Control (DSC). When DSC detects wheelspin, understeer (front-end “plowing”) or oversteer (rear-end sliding), it modulates engine power and can apply brakes individually to help keep the vehicle going in the proper direction. In deep snow or sand, switch to Dynamic Traction Control (DTC), which allows carefully measured wheelspin for optimum grip.

DSC also includes four innovative features. With **Brake Stand-by**, when you lift your foot from the accelerator pedal abruptly – as when emergency braking – the brake pads are shifted closer to the rotors for quicker stopping response. **Brake Drying** occurs when sensors determine it is raining; the brake pads are then periodically and imperceptibly brought into contact with the rotors – just enough to dry off the accumulated moisture and help keep them more effective. When brakes heat up due to hard or repeated use, such as when descending a mountain road, **Brake Fade Compensation** applies the brakes with more force, while you still use the same amount of pedal action. And **Start-off Assistant** helps prevent the vehicle from rolling backwards or forwards when you’re stopped on a hill.

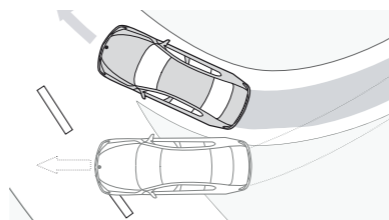

Dynamic Stability Control (DSC) optimizes traction and stability to help keep you going in your intended direction, whether accelerating or braking.



BMW’S PASSIVE SAFETY SYSTEMS: WHAT YOU CAN’T SEE CAN HELP PROTECT YOU.

BMW safety engineers spend a lot of time thinking about the unthinkable: the possible effects of a severe collision. That is why we have, over the decades, developed an impressive array of “passive safety” construction techniques and restraint technologies to help protect you and your passengers.

It starts with the foundation for passive safety: a robust yet weight-optimized body structure employing high-strength steels. In the event of a severe impact, the rigid structure is designed to divert impact forces around the passenger cell, as well as deform in a predetermined way. Three-point safety belts are used at all seating positions; the front safety belts are equipped with electrically driven pretensioners that tighten the belt when sensors anticipate an impact.

That preparedness is one of the many functions of the BMW Advanced Safety System, which coordinates the activation of airbags, front Active Head Restraints, safety-belt pretensioners and more, as needed, in the event of a potential or actual impact. In the 7 Series, BMW’s comprehensive Supplemental Restraint System includes dual-threshold, dual-stage deployment airbags, Active Knee Protection and front-seat side-impact airbags for driver and front passenger. The Head Protection System helps protect occupants, both front and rear.

Should a serious impact occur, the BMW Assist™ system automatically summons emergency help. At the same time, the doors automatically unlock, flashers and interior lights turn on, and the fuel supply is cut off, further helping protect occupants.

Exterior colors.

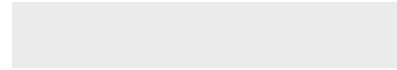

300 Alpine White Non-metallic



668 Jet Black Non-metallic



354 Titanium Silver Metallic



A96 Mineral White Metallic¹



A84 Milano Beige Metallic¹



A72 Cashmere Silver Metallic¹



A52 Space Gray Metallic¹



A90 Dark Graphite Metallic



A76 Deep Sea Blue Metallic¹



A89 Imperial Blue Metallic



896 Blue Water Metallic²



A43 Deep Green Metallic¹



475 Black Sapphire Metallic



416 Carbon Black Metallic³



BMW Individual Exterior Colors



X02 Citrin Black Metallic¹ (BMW Individual)

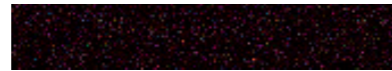

X03 Ruby Black Metallic¹ (BMW Individual)



S34 Azurite Black Metallic¹ (BMW Individual)



X04 Moonstone Metallic¹ (BMW Individual)

The pages in this section show available colors and materials for the BMW 7 Series Sedan. Use these samples to compare paint, upholstery and trim colors. Please note that these samples are representations; they are not exact reproductions. To see the actual colors, visit your local BMW center. They will be happy to show you original samples and assist you with special requests.

Upholstery colors.



LCSW Black Dakota Leather⁴



LCCX Oyster and Black Dakota Leather⁴



LC05 Light Saddle Brown Dakota Leather⁴



NASW Black Nappa Leather⁵



NADH Oyster Nappa Leather⁵



NACX Oyster and Black Nappa Leather⁵



NAD5 Saddle and Black Nappa Leather⁵



BMW Individual Upholstery Colors



ZBC8 Platinum Full Merino Leather⁶



ZBP6 Champagne Full Merino Leather⁶



ZBP5 Amaro Brown Full Merino Leather⁶

Please refer to the Recommended color combinations chart on page 55 for details on limitations and exclusivity when selecting 7 Series upholstery materials and colors.

¹ Not available with M Sport Package.

² Available only on ActiveHybrid models.

³ Requires M Sport Package.

⁴ Standard in 740i and 740Li; not available in other models.

⁵ Optional in 740i and 740Li; standard in all other models.

⁶ Included in and requires optional BMW Individual Composition Package.

Interior trims.



4B7 Fine Line High-Gloss Wood



4CB Fine Line Matte Wood



4CA Ash Grain Wood



4B8 Burl Walnut Wood



BMW Individual Interior Trims



XE5 Dark Red Sycamore Wood



XE6 Walnut Honey Wood



XE8 Piano Finish Black trim

Please refer to the Recommended color combinations chart on the facing page for details on limitations and exclusivity when selecting 7 Series interior trims.

Recommended color combinations.

Upholstery materials	BMW upholstery colors							BMW Individual upholstery colors		
	Dakota Leather ¹			Exclusive Nappa Leather ²				BMW Individual Merino Leather ³		
	Black	Oyster/Black	Light Saddle Brown	Black	Oyster	Oyster and Black	Saddle and Black	Platinum	Champagne	Amaro Brown
Upholstery colors	Black	Oyster/Black	Light Saddle Brown	Black	Oyster	Oyster and Black	Saddle and Black	Platinum	Champagne	Amaro Brown
Exterior colors										
300 Alpine White Non-metallic	*	*	*	*	*	*	*			
668 Jet Black Non-metallic	*	*	*	*	*	*	*	*	*	*
354 Titanium Silver Metallic	*	*	*	*	*	*	*		*	
A96 Mineral White Metallic ⁴	*	*	*	*	*	*	*	*	*	
A84 Milano Beige Metallic ⁴	*	*	*	*	*	*	*		*	
A72 Cashmere Silver Metallic ⁴	*	*	*	*	*	*	*	*	*	
A52 Space Gray Metallic ⁴	*	*	*	*	*	*	*	*	*	
A90 Dark Graphite Metallic	*	*	*	*	*	*	*	*	*	*
A76 Deep Sea Blue Metallic ⁴	*	*	*	*	*	*	*	*	*	*
A89 Imperial Blue Metallic	*	*	*	*	*	*	*	*	*	*
896 Blue Water Metallic ⁵	*	*	*	*	*	*	*	*	*	*
A43 Deep Green Metallic ⁴	*	*	*	*	*	*	*	*	*	*
475 Black Sapphire Metallic	*	*	*	*	*	*	*	*	*	*
416 Carbon Black Metallic ⁶	*	*	*	*	*	*	*	*	*	*
Interior trims										
4B7 Fine Line High-Gloss Wood	*	*	*	*	*	*	*	*	*	*
4CB Fine Line Matte Wood	*	*	*	*	*	*	*	*	*	*
4CA Ash Grain Wood	*	*	*	*	*	*	*	*	*	*
4B8 Burl Walnut Wood	*	*	*	*	*	*	*	*	*	*
BMW Individual exterior colors										
X02 Citrin Black Metallic ⁴	*	*	*	*	*	*	*	*	*	*
X03 Ruby Black Metallic ⁴	*	*	*	*	*	*	*	*	*	*
S34 Azurite Black Metallic ⁴	*	*	*	*	*	*	*	*	*	*
X04 Moonstone Metallic ⁴	*	*	*	*	*	*	*	*	*	*
BMW Individual interior trims										
XE5 Dark Red Sycamore Wood	*	*	*	*	*	*	*	*	*	*
XE6 Walnut Honey Wood	*	*	*	*	*	*	*	*	*	*
XE8 Piano Finish Black	*	*	*	*	*	*	*	*	*	*

¹ Standard in 740i and 740Li; not available in other models.

² Optional in 740i and 740Li; standard in all other models.

³ Included in and requires optional BMW Individual Composition Package.

⁴ Not available with M Sport Package.

⁵ Available only on ActiveHybrid models.

⁶ Requires M Sport Package.

WHITE KNIGHT.

The choice of modern heroes: a 750Li in Mineral White Metallic paint. Mounted on gleaming Multi Spoke alloy wheels and run-flat¹ all-season tires, it's prepared to battle potholed roads and emerge victorious. The interior is clad in classic Saddle Brown and Black Nappa Leather, and trimmed in Fine Line Matte Wood. A Luxury Seating Package adds such pleasures as ventilated front seats and a heated steering wheel, to come to your rescue on the hottest and coldest days.

¹Run-flat tires do not come equipped with a spare tire and wheel.



DRESSED TO THRILL.

Make a dramatic entrance in a 750i Sedan bathed in deep, rich Black Sapphire Metallic paint and accented by Star Spoke alloy wheels. Inside, elegant Oyster Nappa Leather upholstery is set off by dark Ash Grain Wood trim. This 7 Series is available with intelligence features to make a secret agent envious. Night Vision with Pedestrian Detection can not only identify people and animals up to 300 feet away in the dark, it shows the direction of their movements on the iDrive screen and Head-up Display. Later, when it's time to make your exit, hit the accelerator and make a quick getaway – in style.





■ **Xenon Adaptive Headlights** optimize road illumination when cornering at night. Sensors monitor the angle of the steering wheel to determine vehicle direction. The outer headlights swivel accordingly, up to 15 degrees left or right. **Xenon low- and high-beam headlights** illuminate the road ahead and to the side with brilliant clarity. An auto-leveling feature adjusts for varying passenger and cargo loads. The **Corona headlight-rings** that circle both headlights and high beams act as Daytime Running Lights and parking lights. Vertically layered white LED turn-signal indicators also offer increased visibility to oncoming drivers.

■/□ **High-beam Assistant** helps the driver at night by automatically switching between high or low beams, according to the oncoming traffic, vehicles driving ahead, and the quality of road lighting.



■/□ **Comfort Access system** offers keyless access to the vehicle with a multi-function remote control. The **soft-close** feature uses small electric motors to gently close all four doors and the trunk lid.



■ **Door-sill finishers** are constructed with a durable chrome finish. When the doors of the 760Li are opened, a glowing "V12" appears; in all other models, the BMW logo illuminates as part of the soft interior lighting featured with BMW Ambiance lighting.



■ **Adaptive Brake Lights**, shown in the redesigned taillight cluster, consist of layered red LED indicators that offer quicker, heightened vehicle visibility by signaling the intensity of your braking action, thereby warning following drivers to brake quickly.



■ **Dual trapezoidal-shape chrome exhaust tips** are strikingly integrated into the rear bumpers.



□ **V Spoke (Style 302M) M light alloy wheels**, 19x8.5 front, 19x9.0 rear, with 245/45 front, 275/40 rear **run-flat¹ performance tires.²**



□ **Radial Spoke (Style 252) light alloy wheels**, 19x8.5 front, 19x9.5 rear, with 245/45 front, 275/40 rear **run-flat¹ performance tires.²**



■ **Star Spoke (Style 250) 18x8.0 light alloy wheels with 245/50 run-flat¹ all-season tires.**



□ **Double Spoke (Style 253) light alloy wheels**, 20x8.5 front, 20x10.0 rear, with 245/40 front, 275/35 rear **run-flat¹ performance tires.²**



□ **Multi Spoke (Style 235) 19x8.5 light alloy wheels with 245/45² run-flat¹ tires.**



□ **Double Spoke (Style 303M) M light alloy wheels**, 20x8.5 front, 20x10.0 rear, with 245/40 front, 275/35 rear **run-flat¹ performance tires.²**



■ **Double Spoke Star (Style 234) 18x8.0 light alloy wheels with 245/50 run-flat¹ all-season tires.**



■ **Double Spoke (Style 357) light alloy wheels**, 19x8.5 front, 19x9.5 rear, with 245/45 front, 275/40 rear **run-flat¹ performance tires.²**

¹ Run-flat tires do not come equipped with a spare tire and wheel.

² Due to low-profile tires, please note: wheels, tires and suspension parts are more susceptible to road hazard and consequential damages. Performance tires not recommended for driving in snow and ice.

For details on the availability of standard and optional features, please refer to the Standard equipment | Optional equipment charts at the back of this brochure.



■ **Three-spoke leather-wrapped multi-function steering wheel**, featuring power tilt/telescoping adjustments, lets you keep both hands on the steering wheel while adjusting both the audio and a BMW-approved, Bluetooth® enabled mobile phone. The left-hand buttons are used to operate all Cruise Control functions, while those on the right serve the audio functions, such as the radio, telephone and Voice command.



■ **Automatic transmission** provides extremely fast synchronized shifting. Gears are always changed electronically, whether performed in Automatic shift mode or Manual shift mode. The 760Li and ActiveHybrid 7 models offer eight speeds; all other models provide six speeds.

■ **Driving Dynamics Control** allows the driver to choose from four handling and performance settings to adjust ride firmness, transmission shift characteristics, engine-throttle response and power-steering assist.



■ **Dashboard** with four analog instruments shows speed, rpm, fuel level and engine oil temperature above a high-resolution, wide-format Info Display. Also shown, as a graphic display, are the current fuel economy and range, as well as trip computer functions, an odometer and a daily trip recorder.



■ **Black Panel Display** shows the instrument cluster as a matte black surface when the ignition is switched off. Only the chrome rings of the circular instruments (open at the bottom) are visible in 3-D. When the doors are opened, the chrome rings join at the bottom and the analog dials and displays are shown. Then, when the ignition is switched on, the graphics display showing the trip computer and Check Control information light up.



■/□ **Lane Departure Warning system** identifies when the vehicle is getting close to a road marking, and warns the driver by sending a mild vibration through the steering wheel. The system can be turned on and off via a button by the steering wheel.

Requires clearly definable lane markings that are not obscured by rain, snow, etc. Lane Departure Warning feature is not a substitute for the driver's own responsibility in maintaining safe control of the vehicle.



■/□ **Ceramic package** presents a deep black glazed finish to various controls, such as the iDrive Controller bezel, front and rear ventilation controls, and audio controls. The black ceramic provides a rich, custom look and unusually unique feel to the interior.



■ **iDrive Controller** is the central command element for the iDrive system and can be rotated, pushed and tilted to operate various functions via the Control Display. Additionally, four frequently selected menus – CD, radio, Navigation system and telephone – can be called up using direct menu-control buttons.



■ **Memory buttons** provide access to the most frequently used functions of the iDrive system. The eight convenient buttons allow the driver and front passenger to store and then easily access any functions of the Navigation system; the audio system – including specific radio stations or CD tracks; and the Bluetooth enabled mobile phone (if so equipped).



■ **Control Display** shows the functions supported by the iDrive Controller, such as the Navigation system, vehicle settings and radio. The high-resolution 10.2-inch color monitor is located next to the instrument cluster, at an ideal viewing height and distance.



■ **Park Distance Control (PDC)** uses sensors located in the front and rear bumpers to facilitate parking and maneuvering in tight spaces. The driver is kept informed with an audible warning and also a graphic in the iDrive Control Display, showing the distance from the car to an obstacle.



□ When equipped with the optional **Night Vision with Pedestrian Detection** system, the twin-kidney grille is slightly modified. Using nine vertical slats instead of the standard 13 provides an unobstructed view for the infrared camera's lens.



■/□ **Active Blind Spot Detection** warns if a vehicle is in your blind spot, or if a vehicle is approaching at high speed in the passing lane. This feature is activated when you use the turn-signal indicator before changing lanes.



■/□ **20-way power Multi-contour seats**, including four-way lumbar support, conform to your body to provide optimum support and exceptional comfort over long distances. In addition to horizontal, vertical and angled adjustments, seats include an articulated upper backrest, adjustable backrest width, adjustable thigh and adjustable side support, Comfort headrest (two-way power, two-way manual “relax headrest”), and four-way power-adjustable lumbar support. Both driver’s and front-passenger’s seats also include Active Head Restraints and memory function.



■/□ **Heated front seats** are a welcome feature in cooler weather. With the touch of a button, the driver and front passenger can individually select from three heat settings.
 ■/□ **Heated rear seats** keep left and right rear-seat occupants comfortably warm.



□ **Smartphone Integration**, for iPhone® and similar devices, allows access to stored music, can improve signal reception, and recharges the battery. See your authorized BMW center for phone models compatible with this option.



■ **Seat adjustments** for the driver’s and front passenger’s seat positions and head-restraint heights are accessible on the side of each seat. Additionally, all of the driver’s seat settings, as well as the exterior mirrors and steering column settings, are retained with a memory function located on the driver’s-door armrest. The individual settings for two separate drivers can be retained with the driver’s seat memory function.



■ **Lumbar support** in the front seats adds four-way power-adjustable support for the lower back. Lumbar positions can be customized with up/down and in/out adjustments.
 ■/□ **Lumbar support** in the rear Comfort seats soothes occupants.



□ **Massage function** in the rear Comfort seat backrest relaxes the back muscles and provides a soothing sense of well-being. Multiple air chambers generate a wave-like motion from top to bottom, while six rotating elements stimulate the back from the shoulders to the lumbar region.



■ **Front armrest** with integrated storage compartment opens up to allow access to the iPod® and USB adapter port that is included in the optional **Premium Sound Package**. The armrest also conceals the optional Smartphone Integration adapter.



■ **High-fidelity 10-speaker sound system** features two subwoofers under the front seats and 205-watt digital seven-channel amplifier. (Not available in ActiveHybrid 7 models and 760Li.)
 ■/□ **Premium high-fidelity 16-speaker sound system** includes Digital Sound Processing (DSP), two subwoofers under the front seats, and 600-watt digital nine-channel amplifier.



■ **Four-zone automatic climate control** delivers draft-free ventilation. In front, automatic climate control includes fully separate left/right controls, solar sensor, automatic recirculation, and heat-at-rest feature. The rear cabin offers left/right temperature-controlled outlets and auto ventilation.



□ **Rear-seat entertainment** includes two 8-inch color screens integrated into the back of the front seats. The tilt-adjustable monitors can be operated independently. All audio and video sources in the vehicle can be operated from the rear using an additional Controller. (European screens shown.)



■/□ **Rear-view Camera** clearly shows the area behind the vehicle in the Control Display. Working in conjunction with Park Distance Control, interactive guidelines in the Control Display help the driver by showing whether a selected parking space can accommodate the vehicle. Parking trajectories, as well as turn angles, are also shown in the display.



■ **BMW Ambient lighting**, located in the door sills, door handles, map pockets, storage compartments and the back of the front seats, creates a warm red illumination. When the exterior door handles are opened, both the handles and ground below are illuminated for an added margin of safety and convenience.



■ **Vanity mirrors**, which automatically illuminate when accessed, are integrated into the 740Li, 750Li, 750Li xDrive, ActiveHybrid 750Li and 760Li rear rooflining and positioned directly forward of the two outer seats.



■ **Power two-way glass moonroof** with remote, expanded one-touch operation, slides back or tilts up to let in as much fresh air and sky as you like, while a wind deflector helps keep the wind out. Includes a sliding interior sunshade.



■ **Cupholders** are integrated into the front center console and into the center armrest in the rear cabin.

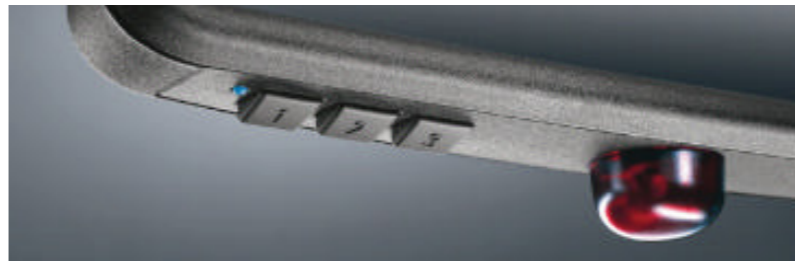

■ **Universal garage-door opener** takes the place of up to three remote-control devices. It can activate remote functions outside the vehicle, such as garage-door openers or home-lighting systems.



■ **Luggage compartment** is illuminated and fully lined. The floor height of the compartment is low enough to offer convenient accessibility when loading and unloading. Compartments in the interior accommodate smaller items securely.

■/□ **Power sunshades** for the rear window and rear-side windows afford protection from the heat and glare of the sun, while shielding occupants from prying eyes.

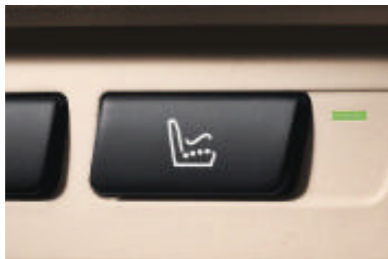

■/□ **Active front seats** help decrease stiffness or fatigue on long trips. When activated, the seat surface is continuously and imperceptibly raised and lowered from side to side, keeping your spine in motion and exercising various support muscles.



■/□ **Heated rear seats** are a welcome feature for left and right rear-seat occupants in cooler weather. With the touch of a button, passengers can individually select their preferred level of warmth.

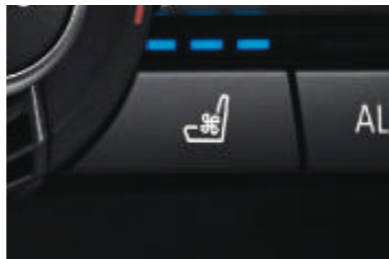

■/□ **Front-seat ventilation** gently blows warm or cool air through the micro-perforations in the leather to keep driver and front passenger comfortably dry in hot weather, and warm in colder weather.

■/□ **iPod® and USB adapter** lets you connect iPods, MP3 players, USB sticks and mobile phones seamlessly with the BMW audio system. Music titles are displayed on the radio or screen as you scroll through and select music by using the vehicle's radio controls, multi-function steering wheel buttons or the iDrive Controller. An **Auxiliary input port** lets you connect an external audio source, such as an iPod or MP3 player.



□ **Six-disc DVD changer** is discreetly integrated into the dash, just above the glovebox. The single-feed changer is readily accessible and supports multi-channel sources as well as compressed audio formats (MP3, WMA, etc.).





M SPORT PACKAGE: ADDING SPORTINESS TO AWESOME POWER.

The **M Sport Package** drives the 7 Series' powerful performance to a higher level. The exterior body styling of the M Aerodynamic kit is enhanced with black shadowline trim around windows and doors. A tri-color M logo on the door sill welcomes you into the sporty cabin that features an M sport multi-function steering wheel and Anthracite Alcantara headliner. Active Roll Stabilization adds extra steady, quick cornering ability; M light alloy wheels with run-flat performance tires¹ enhance its striking looks and sporty handling.



V Spoke (Style 302M) M light alloy wheels, 19x8.5 front, 19x9.0 rear, with 245/45 front, 275/40 rear **run-flat performance tires**.¹

Double Spoke (Style 303M) M light alloy wheels, 20x8.5 front, 20x10.0 rear, with 245/40 front, 275/35 rear **run-flat performance tires**.¹



Three-spoke leather-wrapped multi-function M sport steering wheel features a slightly smaller diameter, thick padding, and special thumb rests for a comfortable grip during sporty driving maneuvers.

¹Run-flat tires do not come equipped with a spare tire and wheel. Due to low-profile tires, please note: wheels, tires and suspension parts are more susceptible to road hazard and consequential damages. Performance tires not recommended for driving in snow and ice.



Luxury's leading edge. In the 760Li,¹ every detail reflects the proud achievements of BMW engineers, designers and artisans. It took generations of these driving enthusiasts to create the swift yet vibration-free acceleration of its TwinPower Turbo V-12 engine. Experience the confidence and ease of navigating challenging traffic situations, aided by an army of innovative active safety features, such as Active Blind Spot Detection. Sit back in the superb 20-way adjustable Multi-contour seats upholstered in supple leather and surrounded by fine wood trim. For the most exclusive way to drive the 760Li, endow it with the BMW Individual Composition 7 Series Package. The 760Li: an automotive tour de force, and BMW's statement of all that luxury, comfort and performance can be.

¹ Model Year 2011 760Li available September 2010.

European model shown.



Signature BMW kidney grille for the 760Li features specially designed chrome trim and vertical slats.



V-12 badge in matte chrome on the front sides features a sleekly integrated turn indicator.



Filigree chrome strip, integrated in the rear bumper between the tailpipes, emphasizes the exclusivity of the 760Li.



Twin tailpipes are integrated in the bumper. Distinguished by their unique, trapezoidal shape, each is set into a chrome surround.



Door sills display an illuminated V-12 insignia for a special welcome into the interior.



The warmth and beauty of the **Burled Walnut Wood trim with inlay** is extended throughout the cabin – even along the front seatbacks, to delight rear-seat passengers.



Interior door handles are lined in fine Nappa Leather and feature Burled Walnut Wood trim with inlay. The Alcantara sunshades and roof-liner emphasize the luxurious character of the cabin.



Interior trim strips in Burled Walnut Wood with inlay enhance the refined look of the dashboard and center console.



CREATE A SPECIAL VEHICLE THAT'S A REFLECTION OF YOU: THE BMW INDIVIDUAL 7 SERIES.

If you have ever wanted to drive a BMW as unique as it is elegant, the BMW Individual Composition 7 Series Package can turn this dream into vibrant reality. In addition to regular 7 Series colors, a choice of four distinctive paints offer greater color intensity and more dramatic effects than traditional metallic paints. An innovative five-coat paint process generates a two-tone iridescence that creates ever-changing nuances in sun and shadow. In the sunlight, Moonstone Metallic and Citrin Black Metallic paint finishes (shown below) shimmer with extraordinarily intense color and millions of tiny sparkling crystals.

Inside, a selection of three upholstery colors and three wood trims are transformed by master craftsmen into a truly stunning customized vehicle. Fine-grain Merino Leather goes through

an extremely mild treatment process to create its exquisite surface and soft, supple texture, which is highlighted by the elegant seat seams and piping exclusive to the BMW Individual 7 Series. Satin-finish Walnut Honey Wood trim artfully sets off the Champagne Leather (shown below). Overhead, the suede-like Alcantara roofliner is perfectly matched to each leather color. The BMW Individual Composition 7 Series Package also adds striking 20-inch wheels (Style 301) with performance tires, and illuminated BMW Individual door-sill finishers.

To learn more about BMW Individual and see the beautiful color and material choices in person, please visit your preferred authorized BMW center. Your BMW client advisor will be happy to tell you more about the BMW Individual Composition 7 Series.



MAKE IT UNIQUELY YOURS – WITH ORIGINAL BMW ACCESSORIES.



Star Spoke (Style 311) 21-inch Chrome wheels with visible wheel studs make a simple yet powerful statement.

Few things enhance the BMW driving experience like Original BMW Accessories. Beautifully designed and expertly crafted, they are created to fit perfectly and last as long as your BMW itself. Complement your vehicle's looks with bold or elegant wheel designs. Enhance its performance with BMW-approved winter tires. Protect the carpeting and trunk with custom

mats. Keep the exterior gleaming with specially formulated car care products. BMW's vast array of products for both the exterior and interior will personalize the pleasures of ownership. For additional information, or to pick up a catalog, please visit an authorized BMW center or visit our website at accessories.bmwusa.com.



BMW Base Support System of high-strength, corrosion-resistant aluminum works with the BMW modular roof rack system.



Gear Selector accented in high-gloss Ash Grain Wood enhances the beauty of the 760Li interior.



Snap-in-adaptor for iPhone® lets you control music and make hands-free calls through the steering wheel or iDrive.

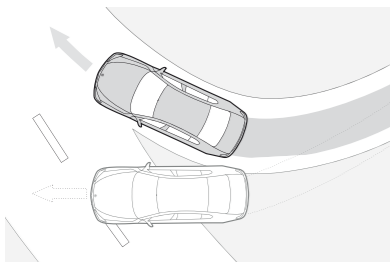

Dynamic Stability Control (DSC) provides remarkable tenacity on slippery road surfaces. If the system senses over- or understeer, it modulates engine power and can apply brakes individually to help keep the vehicle under control and going in the intended direction.

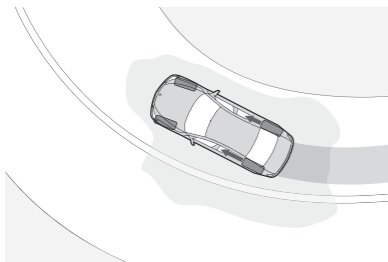

Dynamic Traction Control (DTC) is a sub-function of the DSC system. By raising the threshold for engine and braking interventions, it allows some additional wheelspin. This increases traction on loose surfaces, such as snow and gravel, and also allows the driver to enjoy an even sportier driving style. The DTC function is normally inactive, and must be switched on by pushing the DSC button.

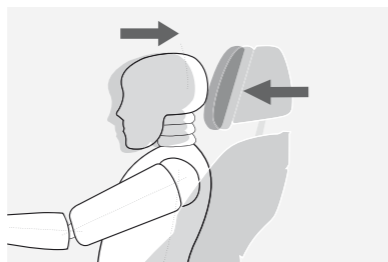

Active Head Restraints in the front seats reduce the risk of whiplash or neck/head/spine injury. When sensors detect a rear-end collision, the headrests rapidly and automatically pivot forward, supporting the driver's and front-seat occupant's heads.



BMW restraint system for the driver and front passenger combines three-point safety belts, automatic safety-belt pretensioners, seat bolsters that help prevent occupants from sliding forward, and Active Head Restraints. This system helps provide optimum restraint in a collision.

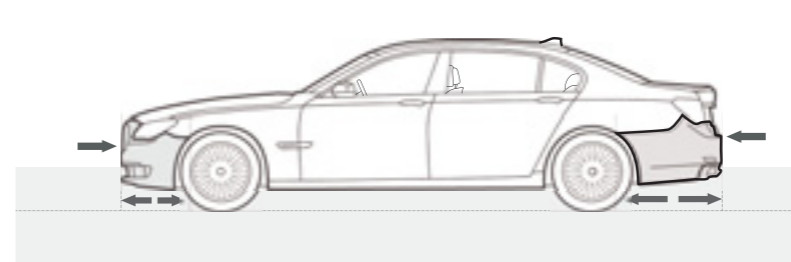

Impact-absorbing bumpers and compressible "crush tubes" front and rear help absorb the force of impact in collisions up to nine mph, minimizing damage to the vehicle's body and simplifying repairs. Only at higher impact speeds do structural supports begin to deform, dissipating impact energy to help protect occupants.

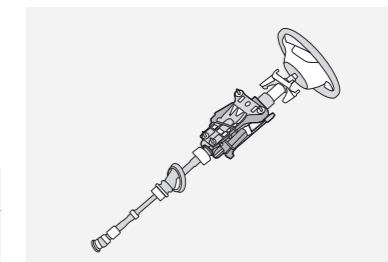

Telescoping steering column system. In a collision, a section of the steering column (the shaft) absorbs a portion of the impact force and collapses, helping to protect the driver.

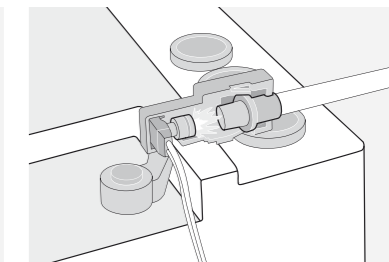

Battery Safety Terminal disconnects the starter cable from the battery in milliseconds after a serious collision, minimizing the risk of an electrical fire. The fuel supply is also cut off automatically. However, warning flashers, interior lights and power windows remain connected.

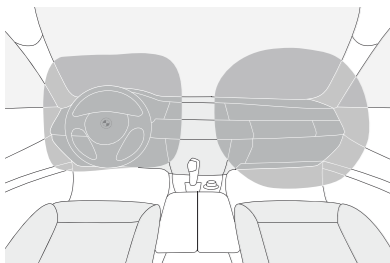

Front airbags help protect the driver's and front passenger's head and torso. In a severe frontal impact, these airbags employ advanced deployment technology. When a safety belt is used, airbags deploy only at a higher crash severity; the force of the deployment depends upon the severity of the impact. **Active Knee Protection** is a special airbag designed to protect front-seat occupants' knees in the event of a severe impact.

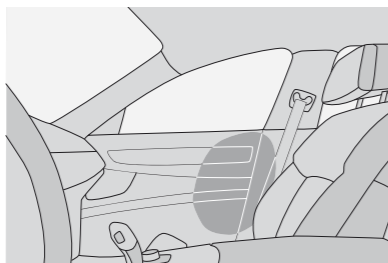

Large-area door-mounted airbags help protect the torsos of driver and front-seat passenger in the event of a side impact.

Please note: These pictures of airbags are for illustrative purposes only. Depending upon the type of accident, none, some or all airbags may deploy.

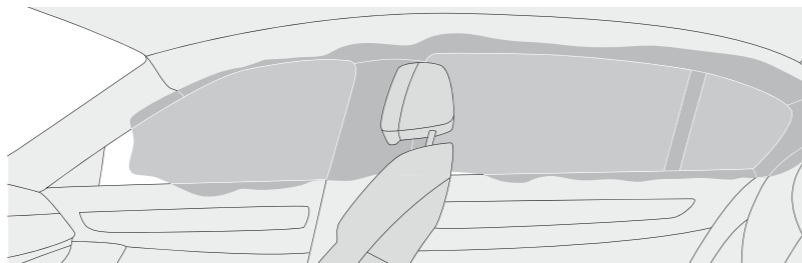

BMW's unique **Head Protection System (HPS)** is designed to help protect the heads of occupants in both front and rear compartments from hitting the side windows, and from being hit by objects penetrating the side windows. In conjunction with the door-mounted airbag, it provides outstanding protection in the case of severe side impact.

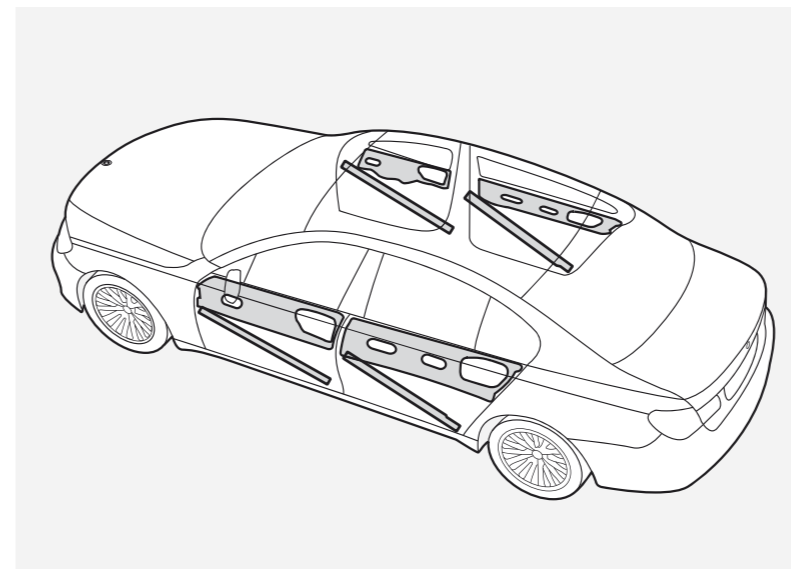

Door anchoring system includes reinforcing bars with hook-like members within each door. In a serious side impact, the bars hook the door to the body, locking them together to make a more rigid passenger cell. When the pressure is released, the anchoring system is designed to disengage so that the doors can be opened (unless further damage from the impact prevents them from opening).

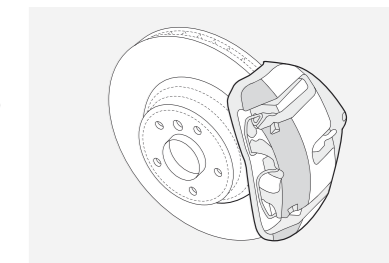

Massive, **high-performance anti-lock disc brakes** are ventilated at all four wheels for fade-resistant operation under hard use. At 14.7" front and 14.5" in the rear, these large brakes offer reassuring confidence.

	740i	750i	750i xDrive	ActiveHybrid 750i	740Li	750Li	750Li xDrive	ActiveHybrid 750Li	760Li
--	------	------	-------------	-------------------	-------	-------	--------------	--------------------	-------

Performance and efficiency									
3.0-liter, dual overhead cam (DOHC), 24-valve, 315-hp inline 6-cylinder engine with TwinPower Turbo technology, piezo direct fuel injection, Valvetronic, and Double-VANOS steplessly variable valve timing	●				●				
4.4-liter, 32-valve 400-hp V-8 engine with TwinPower Turbo technology, High Precision Direct Injection, 4 overhead camshafts, and Double-VANOS steplessly variable valve timing		●	●			●	●		
4.4-liter, 32-valve 455-hp V-8 engine with TwinPower Turbo technology, High Precision Direct Injection, 4 overhead camshafts, Double-VANOS steplessly variable valve timing with electric motor and 120-volt lithium-ion battery				●				●	
6.0-liter, 48-valve 535-hp V-12 engine with TwinPower Turbo technology, High Precision Direct Injection, 4 overhead camshafts, and Double-VANOS steplessly variable valve timing									●
120-volt lithium-ion battery with boost function				●				●	
6-speed automatic transmission with Automatic and Manual shift modes, and fully synchronized electronic gear changes in both	●	●	●		●	●	●		
8-speed automatic transmission with Hybrid Start/Stop function, Automatic and Manual shift modes, and fully synchronized electronic gear changes in both				●				●	
8-speed automatic transmission with Automatic and Manual shift modes, and fully synchronized electronic gear changes in both									●
Brake Energy Regeneration to convert kinetic energy into usable electrical power	●	●	●	●	●	●	●	●	●

Handling, ride and braking									
Anti-lock Braking System (ABS) with Dynamic Stability Control (DSC), including Brake Fade Compensation, Start-off Assistant, Brake Drying, and Brake Stand-by features, with Dynamic Traction Control (DTC), and Dynamic Brake Control	●	●	●	●	●	●	●	●	●
4-wheel ventilated disc brakes with electronic brake proportioning	●	●	●	●	●	●	●	●	●
Driving Dynamics Control	●	●	●	●	●	●	●	●	●
Dynamic Damping Control	●	●	●	●	●	●	●	●	●
xDrive all-wheel-drive system			●				●		
Hill Descent Control			●				●		
Multi-link aluminum double-wishbone front suspension	●	●	●	●	●	●	●	●	●
Integral-V aluminum multi-link rear suspension	●	●	●	●	●	●	●	●	●
Self-leveling air suspension					●	●	●	●	●
Aluminum front and rear subframes	●	●	●	●	●	●	●	●	●
Twin-tube gas-pressure shock absorbers	●	●	●	●	●	●	●	●	●
Vehicle-speed-sensitive variable-assist, variable-ratio rack-and-power steering	●	●	●	●	●	●	●	●	●
Electromechanical parking brake	●	●	●	●	●	●	●	●	●
Active Roll Stabilization (ARS)	○/□	○/□	○/□		○/□	○/□	○/□		●
Integral Active Steering with Servotronic power assist	○	○			○	○			●

- Standard
- Optional
- Included in M Sport Package
- ◆ BMW Individual Composition Package

¹Run-flat tires do not come equipped with a spare tire and wheel.
²Due to low-profile tires, please note: wheels, tires, and suspension parts are more susceptible to road hazard and consequential damage. Performance tires not recommended for driving in snow and ice conditions.

	740i	750i	750i xDrive	ActiveHybrid 750i	740Li	750Li	750Li xDrive	ActiveHybrid 750Li	760Li
--	------	------	-------------	-------------------	-------	-------	--------------	--------------------	-------

Exterior									
Double Spoke (Style 234) 18 x 8.0 light alloy wheels, and 245/50 run-flat ¹ all-season tires	●				●				
Star Spoke (Style 250) 18 x 8.0 light alloy wheels, and 245/50 run-flat ¹ all-season tires		●	●			●	●		
Double Spoke (Style 357) light alloy wheels, 19 x 8.5 front/19 x 9.5 rear, and 245/45 front, 275/40 rear run-flat ¹ performance tires ²				●				●	
Star Spoke (Style 251) light alloy wheels, 19 x 8.5 front/19 x 9.5 rear, and 245/45 front, 275/40 rear run-flat ¹ performance tires ²									●
Radial Spoke (Style 252) light alloy wheels, 19 x 8.5 front/19 x 9.5 rear, and 245/45 front, 275/40 rear run-flat ¹ performance tires ²	○	○			○	○			
V Spoke (Style 302M) M light alloy wheels, 19 x 8.5 front/19 x 9.0 rear, and 245/45 front, 275/40 rear run-flat ¹ performance tires ²	□	□	□		□	□	□		
Double Spoke (Style 303M) M light alloy wheels, 20 x 8.5 front/20 x 10.0 rear, and 245/40 front, 275/35 rear run-flat ¹ performance tires ² (M Sport Package required for 740i, 740Li, 750i, 750i xDrive, 750Li, 750Li xDrive)	○	○	○		○	○	○		□
Multi Spoke (Style 235) light alloy wheels, 19 x 8.5 light alloy wheels, and 245/45 ² run-flat ¹ tires (not available with BMW Individual Composition or M Sport Package)			○				○		
Double Spoke (Style 253) light alloy wheels, 20 x 8.5 front/20 x 10.0 rear, and 245/40 front, 275/35 rear run-flat ¹ performance tires ²				○				○	
V Spoke (Style 254) 18 x 8.0 light alloy wheels, and 245/50 run-flat ¹ all-season tires									○
Double Spoke (Style 301) light alloy wheels, 20 x 8.5 front/20 x 10.0 rear, and 245/45 front, 275/40 rear run-flat ¹ performance tires ²	◆	◆	◆		◆	◆	◆		◆
Xenon Adaptive Headlights with dynamic auto-leveling, Corona headlight-rings and Cornering Lights	●	●	●	●	●	●	●	●	●
Halogen free-form foglights	●	●	●	●	●	●	●	●	●
Intermittent rain-sensing windshield wipers with adjustable and vehicle-speed-sensitive wiping interval, single-wipe control, windshield-washer system with heated washer jets	●	●	●	●	●	●	●	●	●
Body-color bumpers with hydraulic energy absorbers and (front only) compressible elements	●	●	●	●	●	●	●	●	●
Body-color exterior door handles	●	●	●	●	●	●	●	●	●
Power adjustable, power-folding, heated, auto-dimming body-color side-view mirrors	●	●	●	●	●	●	●	●	●
Roof trim strips in body color	●	●	●	●	●	●	●	●	●
Infrared windshield				●				●	●
Climate Comfort laminated glass				●				●	●
Metallic paint	○	○	○	○	○	○	○	○	○
Aerodynamic kit	□	□	□		□	□	□		□
BMW Individual rear badge	◆	◆	◆		◆	◆	◆		◆
High-Gloss black shadowline exterior trim	○/□/◆	○/□/◆	○/□/◆	○	○/□/◆	○/□/◆	○/□/◆	○	○/□/◆

¹Run-flat tires do not come equipped with a spare tire and wheel.
²Due to low-profile tires, please note: wheels, tires, and suspension parts are more susceptible to road hazard and consequential damage. Performance tires not recommended for driving in snow and ice conditions.

	740i	750i	750i xDrive	ActiveHybrid 750i	740Li	750Li	750Li xDrive	ActiveHybrid 750Li	760Li
--	------	------	-------------	-------------------	-------	-------	--------------	--------------------	-------

Interior	740i	750i	750i xDrive	ActiveHybrid 750i	740Li	750Li	750Li xDrive	ActiveHybrid 750Li	760Li
20-way power front Multi-contour seats including 4-way lumbar support, articulated upper backrest, adjustable backrest width, adjustable thigh support, passenger's-seat memory, Active Head Restraints with adjustable side support	◊	●	●	●	◊	●	●	●	●
Memory system for driver's and front passenger's seats, steering wheel, and power-folding outside mirrors (2 positions)	●	●	●	●	●	●	●	●	●
Power rear Comfort seats with 4-way lumbar support, articulated upper backrest, automatic head-restraint height adjustment, automatic safety-belt pretensioners					◆	◆	◆	◆	●
Front console compartment with Auxiliary input, coinholder, and illumination	●	●	●	●	●	●	●	●	●
Heated steering wheel	★	★	★	★	★	★	★	★	●
Heated front seats with fast heating and balance control	★	●	●	●	●	●	●	●	●
Heated rear seats with fast heating and balance control	★	★	★	★	★	★	★	★	●
Active front seats with subtle massage action and ventilated front seats	◊	◊	◊	●	◊	◊	◊	●	●
Rear Comfort seats with ventilation					◆	◆	◆	◆	●
Massage action function for rear Comfort seats					◆	◆	◆	◆	○
Rear center armrest with storage compartment	●	●	●	●	●	●	●	●	●
Dakota Leather upholstery	●				●				
Nappa Leather upholstery	○	●	●	●	○	●	●	●	●
Full Merino Leather upholstery	◊	◊	◊		◊	◊	◊		◊
Leather-covered instrument panel (740i and 740Li require Nappa Leather)	◊	○◊	○◊	●	◊	○◊	○◊	●	●
Fine Line High-Gloss Wood trim (not available with BMW Individual Package)	●	●	●	●	●	●	●	●	●
Fine Line Matte Wood trim (not available with BMW Individual Package)	○	○	○	○	○	○	○	○	○
Ash Grain Wood trim (not available with BMW Individual Package)	○	○	○	○	○	○	○	○	○
Burled Walnut Wood trim with inlay (not available with BMW Individual Package)									●
Piano Finish Black trim	○◊	○◊	○◊		○◊	○◊	○◊		○◊
Dark Red Sycamore Wood trim	○◊	○◊	○◊		○◊	○◊	○◊		○◊
Walnut Honey Wood trim	○◊	○◊	○◊		○◊	○◊	○◊		○◊
Ceramic controls with deep black glazed finish	○	○	○	○	○	○	○	○	●
Anthracite Alcantara headliner				●				●	□
Anthracite headliner	□	□	□		□	□	□		
Alcantara headliner	◊	◊	◊		◊	◊	◊		◊
Rear vanity mirrors					●	●	●	●	●
BMW Individual door-sill finishers	◊	◊	◊		◊	◊	◊		◊
Floor mats	●	●	●	●	●	●	●	●	●

- Standard
- Optional
- Included in M Sport Package
- ◆ Included in Luxury Rear Seating Package
- ◊ Included in Luxury Seating Package
- ★ Included in Cold Weather Package
- ◆ BMW Individual Composition Package
- ☆ Included in Convenience Package

	740i	750i	750i xDrive	ActiveHybrid 750i	740Li	750Li	750Li xDrive	ActiveHybrid 750Li	760Li
--	------	------	-------------	-------------------	-------	-------	--------------	--------------------	-------

Comfort and convenience	740i	750i	750i xDrive	ActiveHybrid 750i	740Li	750Li	750Li xDrive	ActiveHybrid 750Li	760Li
Vehicle & Key Memory	●	●	●	●	●	●	●	●	●
Power 2-way moonroof with key-off and "one-touch" operation, conceal panel and wind deflector	●	●	●	●	●	●	●	●	●
Power windows with key-off operation, "one-touch" open/close and anti-trapping feature	●	●	●	●	●	●	●	●	●
4-zone automatic climate control with draft-free vents featuring automatic front climate control with full separate left/right controls, solar sensor, automatic recirculation, heat at rest feature, left/right temperature-controlled rear outlets, auto ventilation	●	●	●	●	●	●	●	●	●
BMW Ambiance lighting – front, rear and door panels	●	●	●	●	●	●	●	●	●
Adaptive light control for Automatic headlight on/off control	●	●	●	●	●	●	●	●	●
Automatic tilt-down of right outside mirror for visibility of curb when backing up	●	●	●	●	●	●	●	●	●
Automatic-dimming interior rear-view mirror	●	●	●	●	●	●	●	●	●
Park Distance Control, front and rear, with graphic display	●	●	●	●	●	●	●	●	●
Illuminated exterior door handles and ground illumination	●	●	●	●	●	●	●	●	●
Dual cupholders front and rear	●	●	●	●	●	●	●	●	●
Dual illuminated vanity mirrors integrated into rear cabin rooflining					●	●	●	●	●
Integrated Universal garage-door opener	●	●	●	●	●	●	●	●	●
Remote trunk release	●	●	●	●	●	●	●	●	●
Fully finished trunk with emergency interior trunk release	●	●	●	●	●	●	●	●	●
Automatic trunk lid opening and closing	☆	●	●	●	☆	●	●	●	●
Comfort Access keyless entry with multi-function remote control	☆	●	●	●	☆	●	●	●	●
Power trunk lid with push-button close	☆	●	●	●	☆	●	●	●	●
Power soft-close automatic doors	☆	●	●	●	☆	●	●	●	●
Power rear and side window sunshades	○◊	○◊	○◊	○	○◊	○◊	○◊	○	●
Ski bag	★	★	★	●	★	★	★	●	●

	740i	750i	750i xDrive	ActiveHybrid 750i	740Li	750Li	750Li xDrive	ActiveHybrid 750Li	760Li
--	------	------	-------------	-------------------	-------	-------	--------------	--------------------	-------

Premium Sound Package									
Premium high-fidelity 16-speaker sound system with Digital Sound Processing (DSP), 2 subwoofers under the front seats and digital 9-channel amplifier with 600 watts of power	△	△	△	●	△	△	△	●	●
SIRIUS® Satellite Radio with one-year subscription	△	△	△	○	△	△	△	○	●
iPod® and USB adapter (includes cable connector)	△	△	△	○	△	△	△	○	●

Cold Weather Package									
Heated steering wheel	★	★	★	★	★	★	★	★	●
Heated front seats with fast heating and balance control	★	●	●	●	●	●	●	●	●
Heated rear seats with fast heating and balance control	★	★	★	★	★	★	★	★	●
Ski bag	★	★	★	●	★	★	★	●	●

Convenience Package									
Automatic trunk lid opening and closing	☆	●	●	●	☆	●	●	●	●
Comfort Access keyless entry with multi-function remote control	☆	●	●	●	☆	●	●	●	●
Power trunk lid with push-button close	☆	●	●	●	☆	●	●	●	●
Power soft-close automatic doors	☆	●	●	●	☆	●	●	●	●

Driver Assistance Package									
Automatic high beams	■	■	■	■	■	■	■	■	●
Lane Departure Warning ⁵	■	■	■	■	■	■	■	■	●
Active Blind Spot Detection	■	■	■	■	■	■	■	■	●

Rear Entertainment Package									
Rear-seat entertainment, with 2 individual 8-inch color screens	▲	▲	▲	▲	▲	▲	▲	▲	▲
6-disc multi-media changer with MP3 capabilities (ActiveHybrid models: not available with Smartphone Integration)	▲	▲	▲	○	▲	▲	▲	○	●

- Standard
- Optional
- △ Included in Premium Sound Package
- ▲ Included in Rear Entertainment Package
- ★ Included in Cold Weather Package
- ☆ Included in Convenience Package
- Included in Driver Assistance Package
- Included in M Sport Package
- ◇ Included in Luxury Seating Package
- ◆ Included in Luxury Rear Seating Package
- ◇ BMW Individual Composition Package

⁵ Requires clearly definable lane markings that are not obscured by rain, snow, etc. Lane Departure Warning feature is not a substitute for the driver's own responsibility in maintaining safe control of the vehicle.

⁶ Run-flat tires do not come equipped with a spare tire and wheel. Due to low-profile tires, please note: wheels, tires, and suspension parts are more susceptible to road hazard and consequential damage. Performance tires not recommended for driving in snow and ice conditions.

	740i	750i	750i xDrive	ActiveHybrid 750i	740Li	750Li	750Li xDrive	ActiveHybrid 750Li	760Li
--	------	------	-------------	-------------------	-------	-------	--------------	--------------------	-------

M Sport Package									
Active Roll Stabilization (ARS)	○/□	○/□	○/□		○/□	○/□	○/□		●
Power tilt/telescopic leather-wrapped multi-function M sport steering wheel with audio and phone control	□	□	□		□	□	□		□
V Spoke (Style 302M) M light alloy wheels, 19 x 8.5 front/19 x 9.0 rear, and 245/45 front, 275/40 rear run-flat performance tires ⁶	□	□	□		□	□	□		
Double Spoke (Style 303M) M light alloy wheels, 20 x 8.5 front/20 x 10.0 rear, and 245/45 front, 275/40 rear run-flat performance tires ⁶	○	○	○		○	○	○		□
High-Gloss black shadowline exterior trim	○/□/◆	○/□/◆	○/□/◆	○	○/□/◆	○/□/◆	○/□/◆	○	○/□/◆
Aerodynamic kit	□	□	□		□	□	□		□
Anthracite Alcantara headliner				●				●	□
Anthracite headliner	□	□	□		□	□	□		

Luxury Seating Package									
Power rear and side window sunshades	○/◇	○/◇	○/◇	○	○/◇	○/◇	○/◇	○	●
Active front seats with subtle massage action and ventilated front seats	◇	◇	◇	●	◇	◇	◇	●	●
20-way power front Multi-contour seats including 4-way lumbar support, articulated upper backrest, adjustable backrest width, adjustable thigh support, passenger's-seat memory, Active Head Restraints with adjustable side support	◇	●	●	●	◇	●	●	●	●

Luxury Rear Seating Package									
Power rear Comfort seats with 4-way lumbar support, articulated upper backrest, automatic head-restraint height adjustment, automatic safety-belt pretensioners					◆	◆	◆	◆	●
Rear Comfort seats with ventilation					◆	◆	◆	◆	●
Massage action function for rear Comfort seats					◆	◆	◆	◆	○

BMW Individual Composition									
Double Spoke (Style 301) light alloy wheels, 20 x 8.5 front/20 x 10.0 rear, and 245/45 front, 275/40 rear run-flat performance tires ⁶	◇	◇	◇		◇	◇	◇		◇
Leather-covered instrument panel	◇	○/◇	○/◇	●	◇	○/◇	○/◇	●	●
High-Gloss black shadowline exterior trim	○/□/◆	○/□/◆	○/□/◆	○	○/□/◆	○/□/◆	○/□/◆	○	○/□/◆
BMW Individual door-sill finishers	◇	◇	◇		◇	◇	◇		◇
Piano Finish Black trim	○/◇	○/◇	○/◇		○/◇	○/◇	○/◇		○/◇
Dark Red Sycamore Wood trim	○/◇	○/◇	○/◇		○/◇	○/◇	○/◇		○/◇
Walnut Honey Wood trim	○/◇	○/◇	○/◇		○/◇	○/◇	○/◇		○/◇
BMW Individual rear badge	◇	◇	◇		◇	◇	◇		◇
Full Merino Leather upholstery	◇	◇	◇		◇	◇	◇		◇

		740i	750i	750i xDrive	ActiveHybrid 750i	740Li	750Li	750Li xDrive	ActiveHybrid 750Li	760Li
--	--	-------------	-------------	--------------------	--------------------------	--------------	--------------	---------------------	---------------------------	--------------

Weight										
Unladen weight	lbs	4344	4564	4718	4795	4432	4641	4861	4839	5026
Weight distribution, load front/rear	%	50.3/49.7	51.4/48.6	52.8/47.2	51.3/48.7	49.8/50.2	51.5/48.5	52.8/47.2	51.5/48.5	52.4/47.6

Engine										
Type/valves per cylinder		TwinPower Turbo Inline 6/4	TwinPower Turbo V-8/4	TwinPower Turbo V-8/4	TwinPower Turbo V-8/4	TwinPower Turbo Inline 6/4	TwinPower Turbo V-8/4	TwinPower Turbo V-8/4	TwinPower Turbo V-8/4	TwinPower Turbo V-12/4
Displacement	cu cm	2979	4395	4395	4395	2979	4395	4395	4395	5972
Bore/Stroke	inch	3.31/3.53	3.50/3.48	3.50/3.48	3.50/3.48	3.31/3.53	3.50/3.48	3.50/3.48	3.50/3.48	3.50/3.15
Nominal output @ rpm	hp	315 @ 5800-6000	400 @ 5500-6400	400 @ 5500-6400	455 @ 5500-6000 ¹	315 @ 5800-6000	400 @ 5500-6400	400 @ 5500-6400	455 @ 5500-6000 ¹	535 @ 5250-6000
Nominal torque @ rpm	lb-ft	330 @ 1600-4500	450 @ 1750-4500	450 @ 1750-4500	515 @ 2000-3000	330 @ 1600-4500	450 @ 1750-4500	450 @ 1750-4500	515 @ 2000-3000	550 @ 1500-5000
Compression ratio	:1	10.2	10.0	10.0	10.0	10.2	10.0	10.0	10.0	10.0

Transmission										
Automatic gear ratios (6-speed transmission)										
I/II/III	:1	4.17/2.34/1.52	4.17/2.34/1.52	4.17/2.34/1.52		4.17/2.34/1.52	4.17/2.34/1.52	4.17/2.34/1.52		
IV/V/VI	:1	1.14/0.87/0.69	1.14/0.87/0.69	1.14/0.87/0.69		1.14/0.87/0.69	1.14/0.87/0.69	1.14/0.87/0.69		
Automatic gear ratios (8-speed transmission)										
I/II/III/IV	:1					4.71/3.14/2.11/1.67				4.71/3.14/2.11/1.67
V/VI/VII/VIII	:1					1.29/1.00/0.84/0.67				1.29/1.00/0.84/0.67
Reverse gear ratio	:1	3.40	3.40	3.40	3.32	3.40	3.40	3.40	3.32	3.32
Final drive ratio	:1	3.46	3.46	3.46	2.81	3.46	3.46	3.46	2.81	2.81

Performance										
Top speed ²	mph	150	150	150	150	150	150	150	150	150
Acceleration 0-60 ³	sec	5.8	5.1	5.0	4.7	5.9	5.2	5.1	4.8	4.5
Drag coefficient	C _d	0.30	0.31	0.32	0.31	0.30	0.31	0.32	0.31	0.32

Fuel consumption⁴										
City	mpg	17	15	14	17	17	14	14	17	TBD
Highway	mpg	25	22	20	26	25	21	20	26	TBD
Tank capacity, approximate	gal	21.7	21.7	21.7	21.7	21.7	21.7	21.7	21.7	21.7

¹ Includes a 20-hp electric motor and high-performance 120-volt lithium-ion battery.

² Top speed limited electronically.

³ BMW AG test results. Actual acceleration results may vary, depending on specification of vehicle; road and environmental conditions; testing procedures and driving style. These results should be used for comparison only and verification should not be attempted on public roads. BMW urges you to obey all posted speed laws and always wear safety belts.

⁴ EPA-estimated figures are for comparison purposes only. Your actual mileage will vary, depending on speed, driving habits, trip length and driving conditions; actual mileage may be lower.

⁵ Run-flat tires do not come equipped with a spare tire and wheel.

⁶ Due to low-profile tires, please note: wheels, tires, and suspension parts are more susceptible to road hazard and consequential damage. Performance tires not recommended for driving in snow and ice conditions.

		740i	750i	750i xDrive	ActiveHybrid 750i	740Li	750Li	750Li xDrive	ActiveHybrid 750Li	760Li
--	--	-------------	-------------	--------------------	--------------------------	--------------	--------------	---------------------	---------------------------	--------------

Tires and wheels										
Tire dimensions	standard	245 / 50	245 / 50	245 / 50	245 / 45 front 275 / 40 rear	245 / 50	245 / 50	245 / 50	245 / 45 front 275 / 40 rear	245 / 45 front 275 / 40 rear
Type of run-flat ⁵ tire	standard	all-season	all-season	all-season	performance ⁶	all-season	all-season	all-season	performance ⁶	performance ⁶
Wheel dimensions	standard	18.0 x 8.0	18.0 x 8.0	18.0 x 8.0	19 x 8.5 front 19 x 9.5 rear	18.0 x 8.0	18.0 x 8.0	18.0 x 8.0	19 x 8.5 front 19 x 9.5 rear	19 x 8.5 front 19 x 9.5 rear
Material	standard	light alloy	light alloy	light alloy	light alloy	light alloy	light alloy	light alloy	light alloy	light alloy

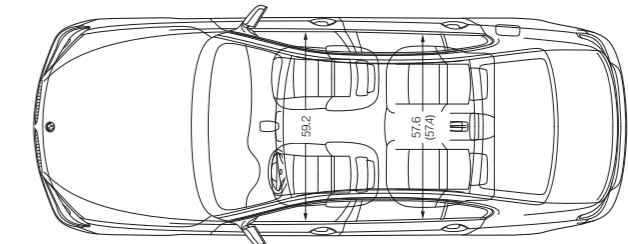
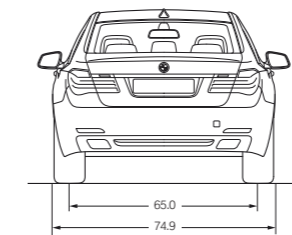
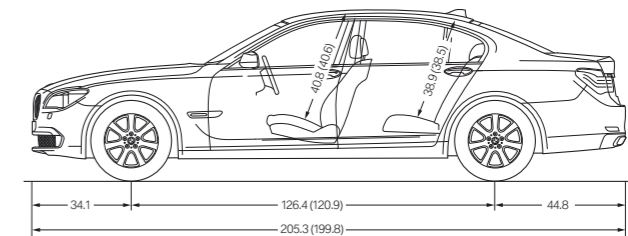
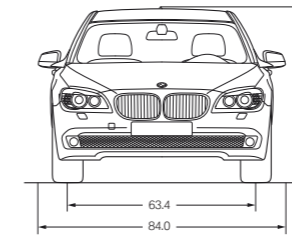

Technical drawing dimensions of 7 Series long-wheelbase models shown in inches. Figures in () refer to the 740i, 750i (short-wheelbase version).

ActiveHybrid 750i height is 58.5 inches; ActiveHybrid 750Li height is 58.4 inches.

Height of 750Li and 750Li xDrive with roof antenna is 58.5 inches; 750i, 750i xDrive and ActiveHybrid 750Li height with roof antenna is 58.7 inches.

Height of ActiveHybrid 750i with roof antenna is 58.8 inches; front track is 63.8 inches; rear track, 64.3 inches.

Width at rear shoulder height in ActiveHybrid models is 57.4 inches.

U.S. Distributor: BMW of North America, LLC, Woodcliff Lake, NJ 07677. All illustrations and specifications contained in this brochure are based on the latest product information available at the time of printing. BMW reserves the right to make changes at any time, without notice, in colors, materials, equipment, specifications and models. BMW may, subject to legal requirements, determine the Model Year designation of its vehicles. The Model Year designation on any particular model may be longer or shorter than 12 months. Some vehicles

pictured may contain non-U.S. equipment. Some models may be shown with optional equipment. While BMW NA makes all reasonable efforts to provide accurate information in this brochure, there is no guarantee or warranty of accuracy. Furthermore, we do not assume any liability for the accuracy or completeness of information presented. This brochure shall not be used or relied upon as a substitute for information that is available from your BMW center. Further information can be obtained from your authorized BMW center or bmwusa.com.

We constantly monitor your BMW's needs – so you don't have to. Tackling mountain switch-backs, the last thing you should be thinking about is the state of your brake pads. Thanks to BMW's integrated on-board diagnostics system, you will always know exactly when the next service is due, and what work will be required.

Condition-Based Service (CBS) measures the condition of key parts that are subject to wear and tear. It also tracks fluid levels and monitors your BMW's time- and mileage-dependent service requirements. Using this data, the Info Display in the cockpit automatically alerts you in advance whenever any part of

JOY IS THE FEELING OF BEING LOOKED AFTER BY THE BEST. BMW SERVICE FOR YOUR BMW.

BMW Ultimate Service.™ At BMW, we believe that a premium ownership experience should feature performance and luxury, as well as safety and convenience. We believe you should be able to drive a BMW to its potential, while enjoying peace of mind and reduced cost of ownership. That's the idea behind BMW Ultimate Service: a suite of comprehensive programs and services that are included in every new vehicle. The New Vehicle/SAV Limited Warranty, the BMW Maintenance Program, Roadside Assistance, and BMW Safety Plan with TeleService come standard. The **New Vehicle/SAV Limited Warranty** provides you with coverage for the first four years or 50,000 miles, whichever comes first. Additionally, you have 12-year, unlimited-mileage warranty protection against corrosion and rust perforation.² **BMW Maintenance Program** is one of the most comprehensive maintenance programs in its class. We cover all factory-recommended maintenance during the New Vehicle/SAV Limited Warranty coverage period. This includes scheduled oil services and inspections. Also covered is the replacement of items that are subject to normal wear and tear, such as brake pads, wiper blade inserts and engine drive belts.³ And, thanks to BMW's advanced engineering, most owners enjoy a well-balanced maintenance schedule, with flexible routine service intervals that can save you time. When your vehicle requires attention, your authorized BMW center ensures that it receives only genuine BMW parts – your assurance of exacting quality standards.

BMW Roadside Assistance is provided free of charge for the first four years – with no mileage limit. Call **1-800-332-4BMW (4269)** for friendly on-the-road help, 24/7, anywhere in the United States, Canada and Puerto Rico. This includes everything from flat-tire changes, emergency gasoline and lock-out service, to towing, alternative transportation and even trip-interruption benefits. This service also provides valuable trip-routing advice.

your vehicle will require servicing. You can also use the iDrive Control Display to find out which components will need to be serviced, and when.

When combined with TeleService – the innovative telematics service included with the BMW Assist™ Safety Plan¹ – the CBS-collected data is automatically transmitted to your BMW center, which then contacts you to set up a service appointment. And because they use only **Original BMW Parts**, you can rely on expert fit and long-lasting BMW quality.

The **BMW Assist** Safety Plan is a four-year program that is included with BMW Ultimate Service for the first four years – with no mileage limit, at no cost. You'll enjoy peace of mind knowing that a friendly response specialist is there to help you, 24/7, at just the push of a button. The Safety Plan includes Automatic Collision Notification, Emergency Request, Enhanced Roadside Assistance, Door Unlock, Stolen Vehicle Recovery and Customer Relations. MyInfo allows you to send business locations and street addresses with their associated phone numbers from the Google Maps™ website directly to your BMW. The destination can be sent to your Navigation system for turn-by-turn directions, and you can call the destination via your Bluetooth® linked cell phone. And for the ultimate in coverage, add the optional **Convenience Plan.**⁴ You'll enjoy unlimited access to personalized Directions, Traffic and Weather reports, as well as our Concierge feature, which can send a destination address and phone number, such as a restaurant or hotel, right to your BMW. You can make up to four operator-assisted calls per year with Critical Calling if your cell phone is not available, or if its battery is discharged. BMW Search allows online access to up-to-date fuel prices and the latest weather forecasts, as well as Bloomberg's stock indices and the powerful reach of the Google Maps database – delivered to the iDrive display right inside your vehicle.

BMW's unique **TeleService**, included in the BMW Assist Safety Plan, continually monitors specific parts that are subject to wear and tear – including the engine oil, micro-filter, spark plugs, brake linings and various fluids – as well as services that require attention at regular intervals, such as vehicle service inspections. This data is automatically transmitted to your BMW center, which will then call you to schedule a service appointment. You don't have to keep track of when your vehicle requires routine maintenance. An added benefit: any needed maintenance service parts will already be on hand, so your BMW is serviced and returned to you as quickly as possible.

For more details on BMW Ultimate Service, visit your authorized BMW center or log on to **bmwusa.com/ultimateservice**.



JOY COMES IN MANY FORMS.

BMW Virtual Center.

If you get the sudden urge to shop for a BMW but your BMW center is closed, there's good news – the BMW Virtual Center is open 24 hours a day! Log on to **bmwusa.com**, and in the top navigation bar, choose “Build Your Own,” and then the model that interests you. Configure the BMW of your dreams, and see what the monthly payments would be. You can even send the specifications to your authorized BMW center, apply for financing, or request a test drive – all online!

BMW Financial Services.

Arranging to buy or lease a BMW is easier than you may think. Your authorized BMW center offers leasing and financing to suit your personal needs through BMW Financial Services.⁵ Start the process at our website, where you can build your “dream vehicle,” get an estimate on a monthly lease or financing payment, submit a credit application to BMW Financial Services – and get approval – all online!⁵ To find out how BMW Financial Services can help put you behind the wheel of your favorite BMW model, log on to **bmwusa.com/fs** or call, toll-free, **1-800-578-5000**.

BMW Publications in the “Media Gallery & Library.”

Sent to new owners and lessees several times a year, **BMW Magazine** is a fascinating view of the latest events and products in the world of BMW, including personality profiles, travel reviews, and the latest BMW technologies. You can read articles from **BMW Magazine** on the BMW website at **bmwusa.com** under the “Media Gallery & Library” heading, found in the “Experience” section. Here, you can also view featured videos and images, read recent news articles, and download BMW wallpapers. While you're there, check out the “News Feed” area to enjoy articles from **Inside Track**. For more information, call Customer Assistance at **1-800-334-4BMW (4269)** or visit BMW online at **bmwusa.com**.

The new **BMW Welt** (“BMW World”) delivery and brand-experience center in Munich is bold proof of BMW's passion for design. When you take advantage of the BMW European Delivery Program,⁶ this is where you will meet your new BMW – in a personalized process that is highly dramatic and totally unforgettable. (You might also realize substantial savings that just may pay for your trip.) While you're there, marvel at the historic BMWs in the Museum; learn about our engineers' newest innovations in the Technology and Design Atelier; and take a tour of the plant to experience firsthand the state-of-the-art methods used to create a BMW. Then comes the unique experience of driving your new BMW on the roads it was designed for. To learn more, visit **bmwusa.com/europeandelivery**.

¹ The BMW Assist and Bluetooth Hands-free Calling system with 4 years of Safety Plan services is standard in the 7 Series. In order to receive BMW Assist services, a subscriber agreement must be completed and transferred to the BMW Assist Response Center. GPS and underlying wireless services must be available and functioning; vehicle ignition must be turned on (except for Door Unlock and Stolen Vehicle Recovery), battery charged and connected and vehicle's electrical system operational; services may be limited to certain geographic areas. Call toll-free **1-888-333-6118**, go to **bmwassist.com**, or visit your BMW center for additional program details. Services are subject to the terms and conditions of your subscriber agreement.

² See your authorized BMW center for details on these limited warranties.

³ The BMW Maintenance Program covers factory-recommended maintenance services as determined by the Service Interval Indicator for all new eligible MY 2004 and later BMW vehicles. Specific additional items that need replacement due to normal wear and tear are also covered. The maintenance coverage period is for the first 4 years or 50,000 miles, whichever comes first. Exclusions from coverage include: gasoline, gasoline additives, windshield washer fluid and additives, battery, tires, wheels, wheel alignment and tire balancing. All work must be performed by an authorized BMW center. See the Service and Warranty Information booklet for specific terms, conditions and limitations. Further information can also be obtained from your authorized BMW center.

⁴ Requires BMW Assist Safety Plan subscription. Services are subject to the terms and conditions of your subscriber agreement. Please go to **bmwassist.com** for additional details on the optional Convenience Plan.

⁵ Subject to credit approval and other terms and conditions.

⁶ Not all models available for BMW European Delivery Program. Please go to **bmwusa.com** or visit your authorized BMW center for details.

More about BMW



bmwusa.com
1-800-334-4BMW

The Ultimate
Driving Machine®

BMW and the environment.

BMW is a strong proponent of the environment and social responsibility. It is important to manage the earth's resources responsibly, and not jeopardize the needs of future generations. That is why BMW makes vehicles that minimize adverse environmental impact, from production (pollution prevention and waste minimization at the plant) through owner use (low emissions) to eventual disposal (easy drainability of all fluid-related components and easy neutralization of all pyrotechnic devices).

This effort has been recognized worldwide and, as a result, we are pleased to have received numerous environmental honors. In the U.S., for example, the Environmental Protection Agency accepted BMW's Spartanburg, SC production and manufacturing facility as a charter member of the agency's National Environmental Performance Track. Internationally, BMW AG – the parent company of both BMW of North America and BMW Manufacturing Co., Spartanburg, SC – was the first automotive company to be represented on the Dow Jones Sustainability Group Index, and has remained on the Index ever since. At BMW, we strive for high performance in everything we do.

©2010 BMW of North America, LLC. Not to be reproduced wholly or in part without written permission of BMW NA. The BMW name, model names and logo are registered trademarks. The Bluetooth word mark and logos are owned by the Bluetooth SIG, Inc. and any use of such marks by BMW is under license. iPhone and iPod are registered trademarks of Apple Inc. Other trademarks and trade names are the property of their respective owners.

BMW recommends Castrol