

1 9 9 8

# CHEVY EXPRESS AND CHEVY VAN



LIKE A ROCK





USDA FOREST SERVICE

G1500 Chevy Van. Shown with conversion and paint by an independent supplier. G2500 Chevy Express LS in Medium Blue-Green Metallic.

## THE ULTIMATE IN PLEASURABLE TRAVEL.

*Full-size ruggedness and strength. Incredible comfort and convenience. Contemporary styling. Impressive safety features. These are the qualities that enable Chevrolet full-size vans to provide an exceptionally pleasurable travel experience. They're built to be dependable, versatile full-size vans. And they're designed to make all your adventures a pleasure, which is exactly what you expect from Chevy Truck — the most dependable, longest-lasting trucks on the road.\**

\*Dependability based on longevity: 1981–1996 full-line light-duty truck company registrations. Excludes other GM divisions.





*G1500 Chevy Van with conversion features and paint by an independent supplier.*

## THE PLEASURES OF A CHEVY VAN CONVERSION VAN.

*With its uncompromising attention to comfort, safety and durability, Chevy Van is ideal for conversions. And a Chevy Van conversion van is the ideal way for you and your family to relax and share the adventures of the road together. To help you get a quality conversion van, our engineers worked with upfitters to make Chevy Van easy to upfit. The result is a vehicle that offers all the comfort, convenience and entertainment features you need to make traveling a pleasure. And the best way to experience this is to get a Chevy Van conversion van out on the road, because after just one trip, you'll realize getting there really is half the fun!*

**NOTE:** Conversion vans are supplied to Chevrolet by outside manufacturers independent of Chevrolet. Chevrolet is not responsible for the safety or quality of design features, materials or workmanship of any alterations by any such manufacturer. Chevrolet does not warrant these alterations. See page 27 for further information about alterations and warranties.



## CUSTOMIZE CHEVY VAN WITH ALL THE COMFORTS OF HOME.

*There are countless journeys all across the country, just waiting for you and your family. There's no better way to experience what America has to offer than in a Chevy Van that has been upfitted by an independent supplier into the conversion van of your choice. A variety of comfort, convenience and entertainment features enable you to customize Chevy Van exactly according to your family's needs. The result is an exceptionally versatile vehicle that takes all the comforts of home and creates an especially pleasurable way to travel.*



**Chevy Van conversion van interior shown with available features provided by an independent supplier.**

NOTE: Here are just a few samples of interior features provided by independent suppliers.

### **REAR SOFA BED.**

For the ultimate in flexibility, your Chevy Van conversion van can be upfitted with attractive features such as a rear seat that easily folds into a roomy and comfortable sofa bed.

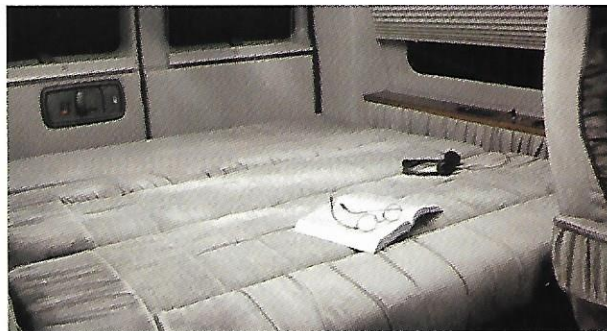

### **REAR-CABIN ENJOYMENT.**

When your Chevy Van conversion van is upfitted with the rear stereo/TV audio control with dual headphone jacks, rear-seat passengers can select the entertainment of their choice.

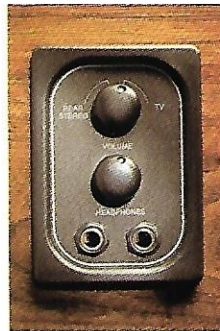



**ENTERTAINMENT CENTER.**

A CD/stereo/game console can transform your Chevy Van conversion van into a self-contained entertainment center.

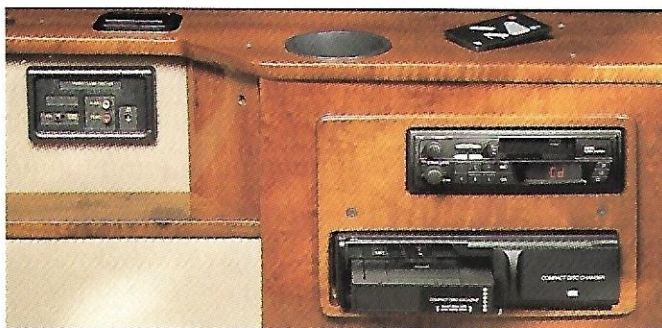

**AIR COMPRESSOR.**

You can upfit your Chevy Van conversion van with handy features such as an air compressor, which lets you quickly and easily inflate sports gear and other items.





G3500 Chevy Express LS Extended Wheelbase in Silvermist Metallic.



## THE PERFECT TRAVELING COMPANION.

*From its truck-tough, full-length chassis to its exceptionally versatile accommodations, Chevy Express delivers everything you and your family need in a full-size passenger van. Whether you choose a regular or extended wheelbase model, you'll discover confident ride and handling on journeys both short and long. Incredible spaciousness for up to 15 people and many features and conveniences are designed to make every trip more enjoyable. In every way, Chevy Express accommodates you — with strength and style.*





*Chevy Express LS interior in Gray Custom Cloth.*

## RELAX IN TOTAL COMFORT.

*In every way, Chevy Express and Chevy Van are designed to make traveling a pleasure for you and your passengers. An abundance of standard features that are literally at your fingertips helps create a soothing and accommodating environment.*

*Generous seating areas provide superb comfort and support.*

*And conveniences such as standard front air conditioning and an available rear air conditioning/heater system (Chevy Express only) help make every mile more pleasant.*

### **REMOTE KEYLESS ENTRY.**

*This optional system provides remote locking and unlocking of doors from up to 30 feet away, and also activates interior lighting.*

*In addition, a single key operates the side and rear doors and the ignition, enhancing convenience as well as security.*



### **ELECTRIC REMOTE OUTSIDE MIRRORS.**

*Available dual power mirrors include a defog feature that helps keep them clear, even in inclement weather conditions.*



### **ADJUSTABLE SHOULDER SAFETY BELT.**

*Sliding shoulder safety belt anchors help the driver and front passenger adjust safety belts for individual comfort.*

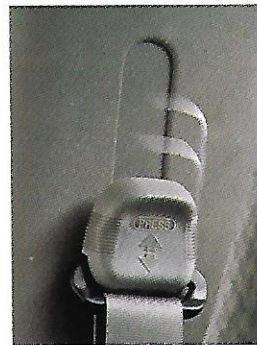

### **CONVENIENCE CENTER.**

*A convenience center for the driver and front passenger includes two cup holders, a covered power outlet and a pull-open, lighted storage bin.*

### **PREMIUM SOUND.**

*The ETR AM/FM stereo premium sound systems are available with a cassette player, a compact disc player, or both cassette and compact disc players (as shown here).*



### **SAFETY BELT COMFORT GUIDES.**

*Outboard shoulder safety belts on Chevy Express feature new adjustable comfort guides to fit older children and small adults. Please refer to your owner's manual for more details.*



*Chevy Express LS instrument panel. Shown with optional equipment.*

## THE OPEN ROAD IS CALLING.

*Chevy Express and Chevy Van provide the features you need to navigate the open road with confidence. From the driver's perspective, the pleasing instrument panel design ensures that all gauges are easy to read and all controls are within easy reach. This thoughtful interior design combines with an excellent view of the road to help provide a sense of security and control, making every journey more enjoyable.*





G3500 Chevy Express LS Extended Wheelbase in Silvermist Metallic.

## FULL-SIZE SPACIOUSNESS, FULL-SIZE CONVENIENCE.

Chevy Express and Chevy Van are not just roomy — they offer the greatest cargo capacity in the full-size van segment.\* With their exclusive design, the rear cargo doors — the tallest and widest in the segment\* — open an unimpeded 165 degrees. And the rear cargo opening is significantly wider than that of either Ford Econoline or Dodge Ram Van. At the side, both the 60/40 swing-out doors and the no-cost optional sliding door operate easily and open wide. It all adds up to exceptional convenience in loading and unloading people as well as cargo.

### **SLIDING SIDE DOOR.**

The optional sliding side door — available at no extra cost — glides open and closes smoothly and features a child safety lock for added peace of mind.



### **REAR-SEAT ACCESS.**

With the front axle and engine moved forward, there is generous room — the most room in the full-size van segment\* — to step between the front seats while the vehicle is parked.

### **WIDE-SWINGING REAR DOORS.**

Rear cargo doors open an unimpeded 165 degrees, giving you enough height and width to easily load a variety of large items.



### **ENTRY-ASSIST REAR BUMPER.**

The standard entry-assist rear bumper design and low step-in height help make it easy to get bulky items in and out.

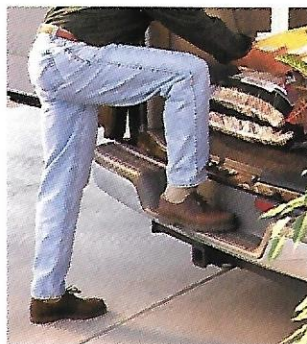

### **AN IDEAL VAN FOR MOBILITY AIDS.**

Chevy Express and Chevy Van are excellent choices for drivers and occupants who use mobility aids. For more information about the GM Mobility Program, please see page 28

\*Extended Wheelbase model. †Excludes other GM vehicles.

## THE LONG-LASTING DEPENDABILITY YOU DEMAND.

No matter how you look at it, Chevy Express and Chevy Van are designed to provide strong, reliable performance. It is this focus on ruggedness and durability in every detail that lies at the heart of Chevy Truck.

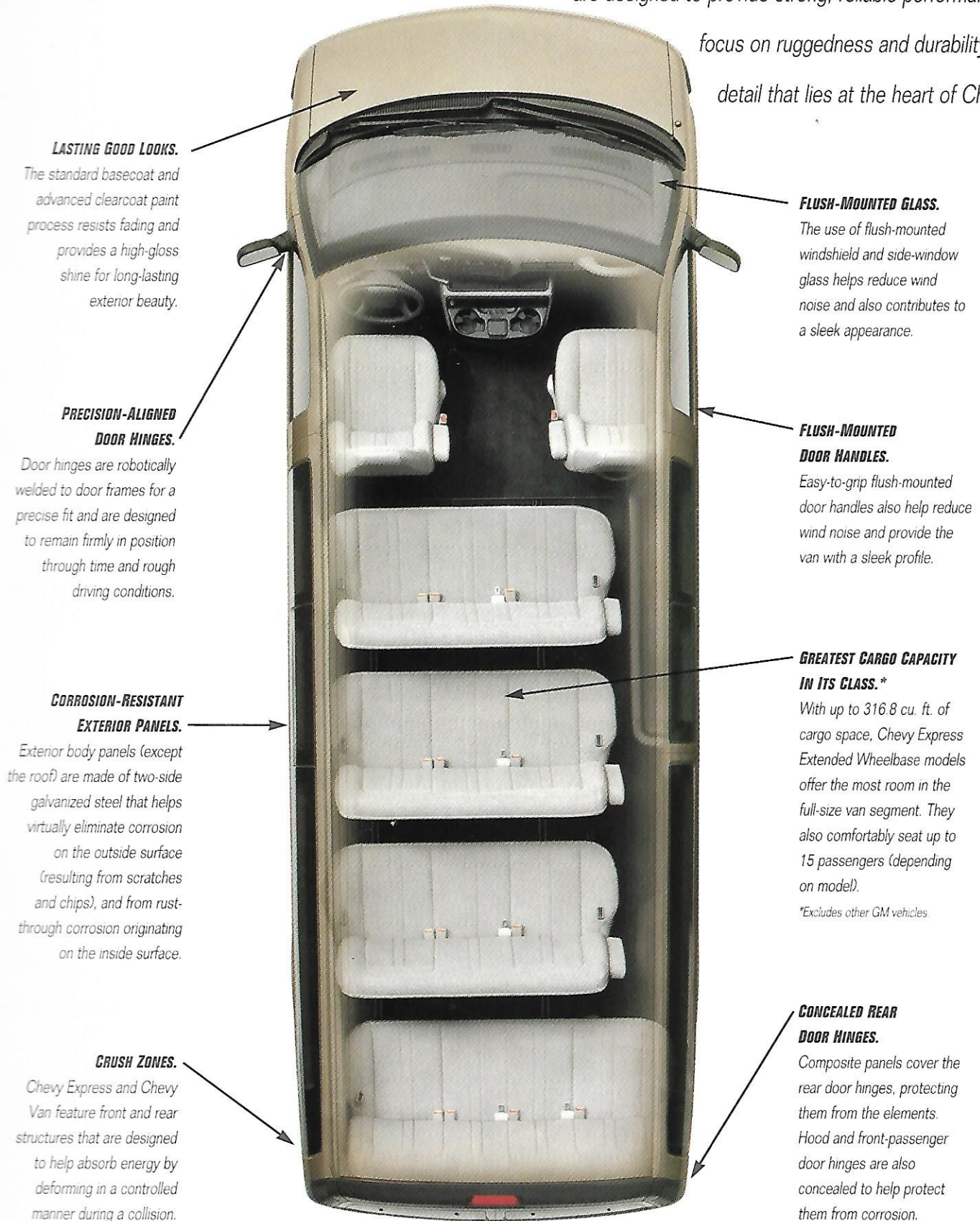

### **LASTING GOOD LOOKS.**

The standard basecoat and advanced clearcoat paint process resists fading and provides a high-gloss shine for long-lasting exterior beauty.

### **PRECISION-ALIGNED DOOR HINGES.**

Door hinges are robotically welded to door frames for a precise fit and are designed to remain firmly in position through time and rough driving conditions.

### **CORROSION-RESISTANT EXTERIOR PANELS.**

Exterior body panels (except the roof) are made of two-side galvanized steel that helps virtually eliminate corrosion on the outside surface (resulting from scratches and chips), and from rust-through corrosion originating on the inside surface.

### **CRUSH ZONES.**

Chevy Express and Chevy Van feature front and rear structures that are designed to help absorb energy by deforming in a controlled manner during a collision.

### **FLUSH-MOUNTED GLASS.**

The use of flush-mounted windshield and side-window glass helps reduce wind noise and also contributes to a sleek appearance.

### **FLUSH-MOUNTED DOOR HANDLES.**

Easy-to-grasp flush-mounted door handles also help reduce wind noise and provide the van with a sleek profile.

### **GREATEST CARGO CAPACITY IN ITS CLASS.\***

With up to 316.8 cu. ft. of cargo space, Chevy Express Extended Wheelbase models offer the most room in the full-size van segment. They also comfortably seat up to 15 passengers (depending on model).

\*Excludes other GM vehicles.

### **CONCEALED REAR DOOR HINGES.**

Composite panels cover the rear door hinges, protecting them from the elements. Hood and front-passenger door hinges are also concealed to help protect them from corrosion.



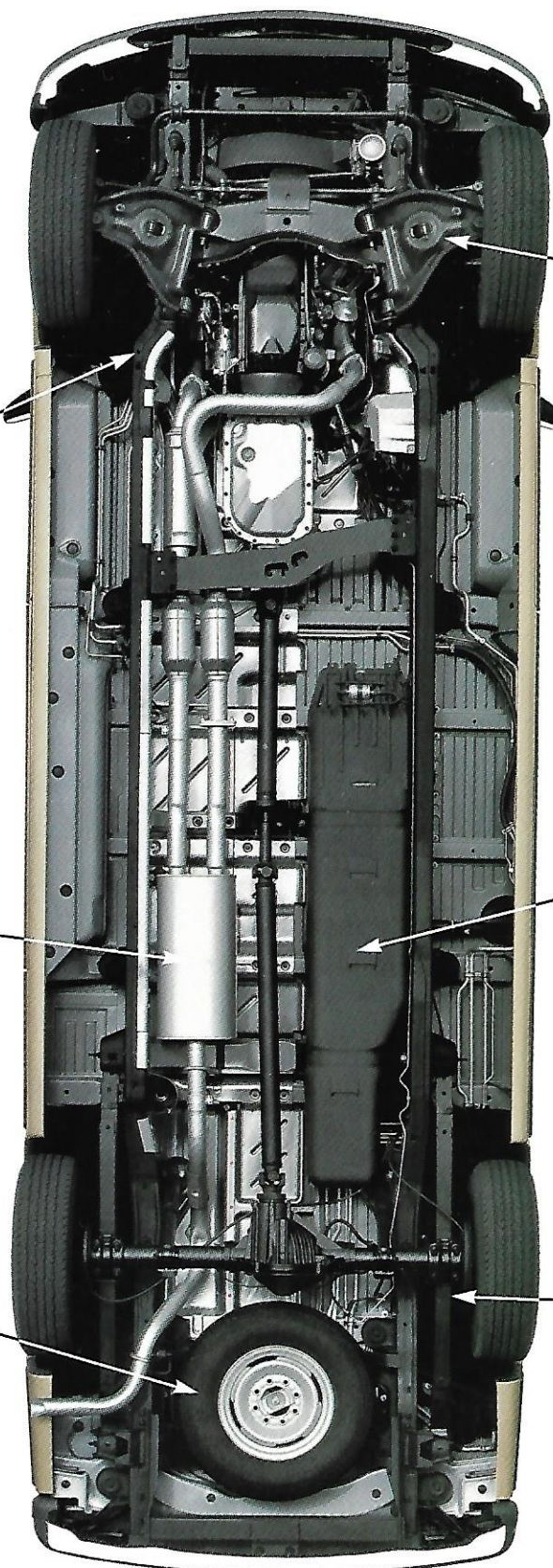

**STEEL LADDER-TYPE FRAME.**

Exceptional strength and rigidity are provided by a steel ladder-type frame with boxed front sections that help support the engine and transmission.

**STAINLESS-STEEL EXHAUST SYSTEM.**

Made of corrosion-resistant aluminized stainless steel, the muffler and all pipes from the converter back are designed to provide long-lasting durability.

**UNDERBODY SPARE TIRE.**

Mounted beneath the vehicle floor, the spare doesn't interfere with cargo space inside the van, leaving more room for gear.

**INDEPENDENT FRONT SUSPENSION.**

Every Chevy Express and Chevy Van features a rugged and reliable independent front suspension that helps keep the front wheels virtually straight up and down at all times, for a stable ride and precise control.

**LARGE-CAPACITY FUEL TANK.**

With a standard 31-gallon fuel tank, Chevy Express and Chevy Van are designed to travel a long way between fill-ups.

**TWO-STAGE MULTI-LEAF REAR SPRINGS.**

Specially designed second-stage springs engage as load weight increases to provide additional support without sacrificing ride quality.



**G3500 Chevy Express LS Extended Wheelbase in Dark Copper Metallic.**

*Day in and day out, Chevy Express provides you with uncompromised versatility — which is exactly what you expect from a full-size passenger van. A wide variety of seating configurations is designed to meet your needs for carrying people and all their gear. This focus on function meets its match in an equally strong focus on convenience to help ensure that all your travels are pleasant.*



**EXCELLENT AIR CIRCULATION**

For enhanced passenger comfort all the way to the back row, ceiling vents help circulate air on Chevy Express models with optional rear heating and air conditioning.

UNLIMITED VERSATILITY.



**VERSATILE SEATING FOR 5 TO 15 PASSENGERS.**

Chevy Express models offer seating configurations for 5, 8, 12 or 15 passengers, with availability depending on the selected model.

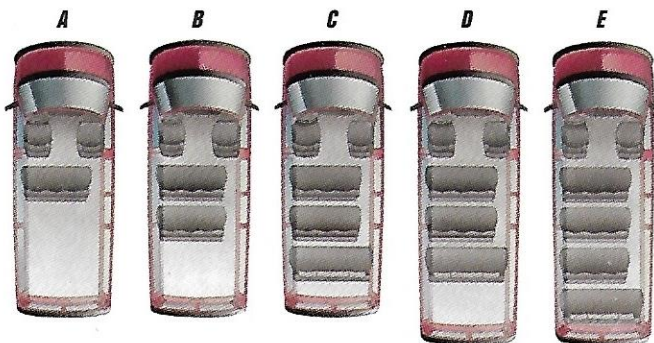

**SEATING CONFIGURATIONS**

SERIES/MODEL	WHEELBASE	PASSENGER CAPACITY (CONFIGURATION)	
		STANDARD	OPTIONAL
G1500 Chevy Express	135"	8 (B)	5 (A)
G2500 Chevy Express	135"	12 (C)	8 (B)
G3500 Chevy Express	135"	12 (C)	8 (B)
G2500 Chevy Express Extended	155"	12 (D)	—
G3500 Chevy Express Extended	155"	12 (D)	15 (E)
All Chevy Van conversion vans	135"/155"	*	*

\*Seating depends on conversion van features added by an independent supplier.



G1500 Chevy Van in Summit White with conversion by an independent supplier.

## HELPING YOUR FAMILY STAY SAFE AND SECURE.

Safety for your family is among your top priorities in a full-size van. That's why Chevy full-size vans are designed to help provide you and your family with the added safety, security and peace of mind that come from a comprehensive list of safety features. Included are features such as Next Generation driver and front-passenger air bags,\* side door beams, Daytime Running Lamps and four-wheel ABS. You also have the security of the new standard Passlock® theft-deterrent system. Chevy full-size vans help provide security for you and your family, mile after mile.

*\*Always wear safety belts, even with air bags. Also see note below on child safety. Next Generation front-passenger air bag will be available interim 1998 model year.*

### **PASSLOCK® THEFT-DETERRENT SYSTEM.**

All Chevy Express and Chevy Van models now feature the security of the Passlock® theft-deterrent system as standard equipment. Passlock® automatically disables the vehicle's ignition system if the proper key is not used.



### **SIDE DOOR BEAMS.**

Double-wall steel front and side doors are reinforced with structural steel beams designed to help avoid intrusions into the passenger compartment during shallow side-angle collisions.

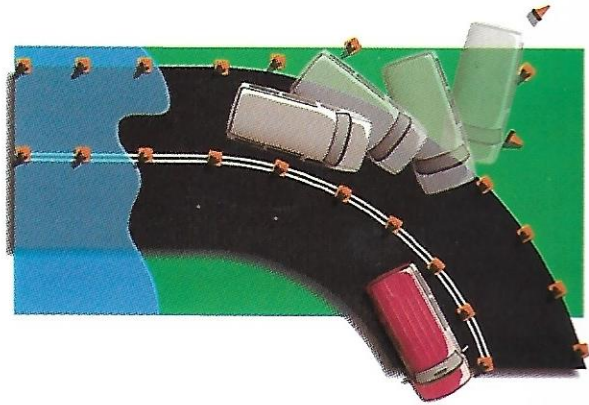

### **STANDARD FOUR-WHEEL ANTI-LOCK BRAKE SYSTEM (ABS).**

Standard on all Chevy Express and Chevy Van models, four-wheel ABS is designed to help keep control by reducing wheel lockup while braking on most slippery surfaces.

### **DAYTIME RUNNING LAMPS.**

During daytime driving, reduced-intensity beam headlamps come on automatically to alert roadway users to your oncoming vehicle.



**A NOTE ON CHILD SAFETY:** Children are generally safer if they ride in a rear seat using the appropriate child safety seats and restraints, which is why General Motors recommends that child safety seats be properly secured in a vehicle's rear seat. This includes an infant or child riding in a rear-facing seat or a forward-facing child seat, and an older child riding in a booster seat. Make sure the child is properly restrained in the safety seat. See your vehicle's owner's manual and child safety seat's instructions for more information.



*G2500 Chevy Express LS Regular Wheelbase in Medium Blue-Green Metallic.*

## THE LONG-LASTING DEPENDABILITY OF VORTEC POWER.

Whether traveling across town or across the country, you need strong, reliable performance. That's exactly what you get with the impressively responsive Vortec V6 and powerful Vortec V8 gasoline engines offered in Chevy Express and Chevy Van conversion van. With their blend of power, efficiency and reliability, Vortec engines help you haul, tow and pass with ease. If you need substantial low-end torque for heavy hauling or trailering, a Turbo-Diesel V8 is available.

### 100,000-MILE MAINTENANCE.

Platinum-tip spark plugs help Vortec engines travel up to 100,000 miles before their first scheduled tune-up.\* And the recommended engine coolant change interval is up to 150,000 miles or five years, whichever comes first.\*

\*Maintenance needs vary with different uses and driving conditions. See your owner's manual for more information.



### EFFICIENT FUEL DELIVERY.

Sequential Fuel Injection (SFI) ensures precise, high-pressure fuel delivery to each cylinder, making efficient use of every drop of gasoline.

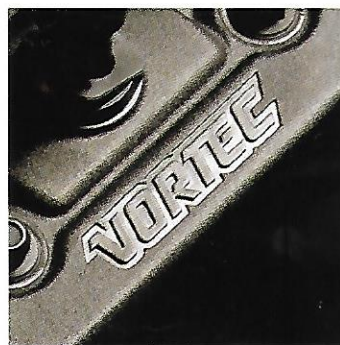

### STANDARD VORTEC POWER.

The Vortec V6 and Vortec V8 gasoline engines deliver impressive power to haul, tow and pass, along with smooth, quiet operation. And the Vortec 7400 V8\* is the most powerful gasoline V8 in the full-size van class.†

\*Not available on Chevy Van with Conversion Package.  
†Excludes other GM vehicles.

## POWERTRAIN SPECIFICATIONS

ENGINE	VORTEC GASOLINE ENGINES				DIESEL ENGINE
	VORTEC 4300 V6 SFI <sup>1</sup> (RPO L35)	VORTEC 5000 V8 SFI <sup>1</sup> (RPO L30)	VORTEC 5700 V8 SFI <sup>1</sup> (RPO L31)	VORTEC 7400 V8 SFI <sup>1</sup> (RPO L29)	6.5L TURBO-DIESEL V8 <sup>2</sup> (RPO L65)
Displacement (liters)	4.3	5.0	5.7	7.4	6.5
HP @ RPM	200 @ 4400	220 @ 4600	245 @ 4600 <sup>3</sup>	290 @ 4000	190 @ 3400
Torque (lb.-ft.) @ RPM	250 @ 2800	280 @ 2800	325 @ 2800 <sup>4</sup>	410 @ 3200	385 @ 1800
TRANSMISSION	4-SPEED AUTOMATIC OVERDRIVE <sup>5</sup>	4-SPEED AUTOMATIC OVERDRIVE <sup>5</sup>	4-SPEED AUTOMATIC OVERDRIVE <sup>5, 6</sup>	4-SPEED AUTOMATIC OVERDRIVE <sup>5, 6</sup>	4-SPEED AUTOMATIC OVERDRIVE <sup>5, 6</sup>
AVAILABILITY	WHEELBASE (IN.)	GVWR (LBS.) <sup>7</sup>			
<b>CHEVY EXPRESS</b>					
G1500	135	7100	S	O	O
G2500	135	8600	-	S	O
G2500 Extended	155	8600	-	S	-
G3500	135	9500	-	S	O
G3500 Extended	155	9500	-	S	O
<b>CHEVY VAN (WITH CONVERSION PACKAGE)<sup>8</sup></b>					
G1500	135	7100	S	O	-
G2500	135	8600	-	S	O
G2500 Extended	155	8600	-	S	O
G3500	135	9500	-	S	O
G3500 Extended	155	9500	-	S	O

S — Standard. O — Optional.

<sup>1</sup> Sequential Fuel Injection. <sup>2</sup> This diesel engine includes an exclusive warranty for 5 years or 100,000 miles, whichever comes first. A \$100 deductible per repair visit applies after 3 years/36,000 miles. See your Chevy Truck dealer for terms and conditions of this limited warranty. <sup>3</sup> 250 hp @ 4600 with GVWRs at 8,600 lbs. or above. <sup>4</sup> Torque 330 lb.-ft. @ 2800 with GVWRs at 8,600 lbs. or above. <sup>5</sup> With brake/transmission shift interlock. <sup>6</sup> Heavy-duty transmission with GVWRs at 8,600 lbs. or above. <sup>7</sup> Gross Vehicle Weight Rating. includes vehicle, passengers, equipment and cargo. <sup>8</sup> For information about Chevy Van cargo models for commercial use and G3500 RV and Commercial Gateway Vans, please see your Chevy Truck dealer.



*G1500 Chevy Van in Medium Storm Gray Metallic with conversion by an independent supplier.*



## FULL-SIZE STRENGTH MAKES TRAILERING EASY.

With their full-frame ruggedness and strength, Chevy Express and Chevy Van have what it takes to meet your trailering needs. Each powertrain's standard cooling system is capable of attaining the maximum trailer rating. With the optional Trailering Package, including a heavy-duty weight-distributing trailer hitch platform and 8-lead trailer wiring harness, your new van is ready to handle a variety of trailering situations without a lot of additional, expensive options.

### TRAILERING CAUTION.

If you don't use the correct equipment and drive properly, you can lose control of your vehicle when you pull a trailer. For example, if the trailer is too heavy, your vehicle brakes may be less effective. You and your passengers could be seriously injured. Pull a trailer only after you have taken the following steps.

### TRAILER BRAKES.

If your trailer weighs more than 1,000 lbs. loaded, then it must have its own adequate brakes. Be sure to read and follow the instructions for the trailer brake controller so that it is installed, adjusted and maintained properly.

- Don't tap into your vehicle's brake system if the trailer's brake system will use more than 0.02 cu. in. of fluid from your vehicle's master cylinder. If it does, neither braking system will work well. You could even lose your vehicle brakes.
- The trailer brake parts must be able to take 3,000 psi of pressure. If not, the trailer brake system must not be used with your vehicle.

If everything checks out thus far, have a qualified individual make the brake fluid tap at the port on the master cylinder that sends fluid to the rear brakes. Don't use copper tubing, because it will bend and ultimately break. Use only steel brake tubing.

### HITCHES.

It's important to have the correct hitch equipment. Crosswinds, large trucks going by and rough roads are just a few of the reasons why you'll need the right hitch. Here are some rules to follow:

- If you'll be towing a trailer that, when loaded, will weigh more than 4,000 lbs., be sure to use a frame-mounted, weight-distributing hitch and sway control of the proper size. This equipment is very important for proper vehicle loading and good handling when you're driving.
- If you have to make any holes in the body of your vehicle to install a trailer hitch, be sure to seal the holes if you ever remove the hitch. If they're not sealed, dirt, water and dead carbon monoxide from the exhaust can get into your vehicle.

**NOTE:** Your vehicle may require additional special equipment to tow the maximum trailer weights listed here. The weight-carrying hitch limit for Chevy Express/Chevy Van models is a 4,000-lb. trailer with 400-lb. tongue weight. A weight-distributing hitch is required with trailer weights over 4,000 lbs.

### TRAILERING — VORTEC GASOLINE ENGINES

ENGINE TRANSMISSION	VORTEC 4300 V6 AUTOMATIC			VORTEC 5000 V8 AUTOMATIC			VORTEC 5700 V8 AUTOMATIC			VORTEC 7400 V8 AUTOMATIC		
	MAX. TRAILER WEIGHT (LBS.) <sup>1</sup>	MAX. TONGUE LOAD (LBS.)	REQUIRED AXLE RATIO	MAX. TRAILER WEIGHT (LBS.) <sup>1</sup>	MAX. TONGUE LOAD (LBS.)	REQUIRED AXLE RATIO	MAX. TRAILER WEIGHT (LBS.) <sup>1</sup>	MAX. TONGUE LOAD (LBS.)	REQUIRED AXLE RATIO	MAX. TRAILER WEIGHT (LBS.) <sup>1</sup>	MAX. TONGUE LOAD (LBS.)	REQUIRED AXLE RATIO
G1500	4000	500	3.42	5000	600	3.42	5500	700	3.42	6500	800	3.73
	4500	550	3.73				6500	800	3.73			
G2500	4000	500	3.42	5000	600	3.42	5500	700	3.42	5500	700	3.73
	4000	500	4.10				7000	850	4.10			
G3500							5500	700	3.73	6500	800	3.42
							7000	850	4.10	8000	950	3.73
										10,000	1000	4.10

<sup>1</sup> Maximum trailer weight is calculated assuming the driver and one passenger are in the tow vehicle and it has all required trailering equipment. The weight of additional optional equipment, passengers and cargo in the tow vehicle must be subtracted from the maximum trailer weight.

**NOTE:** The vehicle owner is responsible for obtaining the hitch ball, a hitch of the proper size, type and capacity, and other appropriate equipment required to safely tow both the trailer and the load that will be towed. Ask your Chevrolet dealer advice about towing and the proper towing equipment for your new vehicle.

### TRAILERING — DIESEL ENGINE

ENGINE TRANSMISSION	6.5 LITER TURBO-DIESEL V8 AUTOMATIC		
	MAX. TRAILER WEIGHT (LBS.) <sup>1</sup>	MAX. TONGUE LOAD (LBS.)	REQUIRED AXLE RATIO
G2500	6500	800	3.73
	8000	950	4.10
G3500	6000	750	3.73
	7500	900	4.10

<sup>1</sup> Maximum trailer weight is calculated assuming the driver and one passenger are in the tow vehicle and it has all required trailering equipment. The weight of additional optional equipment, passengers and cargo in the tow vehicle must be subtracted from the maximum trailer weight.

**NOTE:** The maximum weight-carrying trailer hitch limit for all Chevy Express/Chevy Van models is a 4,000-lb. trailer with a 400-lb. tongue weight. • A Heavy-Duty Trailering Package (RPO Z82) is available and includes a weight-distributing hitch platform and 8-lead trailer wiring harness. • Model availability of driveline combinations must be verified by your Chevrolet dealer for correct emissions equipment.

### GROSS COMBINATION WEIGHT RATINGS (GCWRs)

ENGINE	AXLE RATIO	GCWR (LBS.)	ENGINE	AXLE RATIO	GCWR (LBS.)
Vortec 4300 V6	3.42	9500	Vortec 7400 V8	3.42	13,500
	3.73	10,000		3.73	15,000
	4.10	10,500		4.10	17,000
Vortec 5000 V8	3.42	10,500	6.5 Liter Turbo-Diesel V8	3.73	10,000
Vortec 5700 V8	3.42	11,000		4.10	14,500
	3.73	12,000			
	4.10	13,500			

### THE USE OF GCWRs TO DETERMINE ENGINE, TRANSMISSION AND REAR AXLE RATIOS:

Perhaps you prefer to use Gross Combination Weight Ratings (GCWRs) to determine the powertrain you will require to tow a specific trailer with your van. The chart above shows you the maximum allowable GCWR based on all the available truck engines and rear axle ratios. The GCWR includes the total loaded weight of both the van and the trailer. Any available engine may be used for trailering if the GCWR shown is not exceeded.



*G3500 RV Cutaway Van in Summit White. Shown with camper body from an independent supplier and additional options.*

**DESIGNED FOR YOUR ADVENTUROUS SPIRIT.**

*If you're looking for a large, dependable, long-lasting RV chassis, the full-frame G3500 RV Cutaway Van is for you. Available in three different wheelbase lengths — 139", 159" and 177" — the Cutaway Van can be equipped with your choice of Vortec or Turbo-Diesel V8 engines. See your dealer for more information.*





**CAMPER BODY OPTION**

For the ultimate in travel versatility, the G3500 RV Cutaway Van can be upfitted with a wide range of attractive camper bodies from an independent supplier.

**NOTE:** The safety and productivity of your completed vehicle require that the addition of a body or equipment and/or any other type of alteration be performed in accordance with all applicable Federal Motor Vehicle Safety Standards and in accordance with prudent engineering principles. Vehicle completion and/or alteration should be performed only by professional, reputable intermediate and final-stage manufacturers or vehicle alterers. Consumers are urged to inquire as to the facilities, trained personnel and professional group affiliations of the intermediate and/or final-stage manufacturer or vehicle alterer that may install a body or equipment on your Chevrolet chassis or perform any type of alteration to your vehicle. Make sure your supplier uses the proper equipment to the exact specifications required to make your Chevrolet perform as it was intended.



*G3500 Chevy Express LS Extended Wheelbase in Dark Carmine Red Metallic.*

# GENUINE CUSTOMER CARE. YOU NEVER TRAVEL ALONE.

## NEW VEHICLE LIMITED WARRANTY

This warranty is for GM vehicles registered in the United States. Please see your Chevrolet dealer for complete terms and conditions of this New Vehicle Limited Warranty.

## WHAT IS COVERED FOR 3 YEARS/36,000 MILES:\*



The complete vehicle



Sheet-metal coverage:  
 ■ Corrosion coverage  
 ■ Rust-through coverage<sup>†</sup>



Tires



Repairs made to correct any vehicle defect



Towing to your nearest Chevrolet dealership



No charge for warranty repairs.

\*Whichever comes first. <sup>†</sup>6 years or 100,000 miles, whichever comes first.

## AN IMPORTANT NOTE ABOUT ALTERATIONS AND WARRANTIES.

Installations or alterations to the original equipment vehicle (or chassis) as distributed by General Motors are not covered by the General

Motors New Vehicle Warranty. The special body company, assembler, equipment installer or upfitter is solely responsible for warranties on the

body or equipment and any alterations (or any effect of the alterations) to any of the parts, components, systems or assemblies installed by GM.

## COURTESY TRANSPORTATION

Customers who purchase or lease a 1998 Chevy Express or Chevy Van are eligible for Courtesy Transportation (at no charge) when their vehicles are left at a participating dealership for repairs

covered under the 3-year/36,000-mile New Vehicle Limited Warranty. Courtesy Transportation, at participating dealers only, may include shuttle service, expense reimbursement

or, if the repair requires the vehicle to stay at the dealership overnight, vehicle rental. Actual services may vary at the election of the participating dealer. See your dealer for details.

## ROADSIDE ASSISTANCE\*

Roadside Assistance service is provided through a toll-free 800 number, 24 hours a day, 365 days a year. Roadside Assistance advisors can assist with minor mechanical problems over the phone or coordinate a variety of services through Chevrolet dealers' preferred service providers.

## BASIC CARE PROVIDES:



Toll-free access  
1-800-CHEV-USA



Basic over-the-phone technical advice



Free towing to nearest dealer for warranty repairs



Dealer services at reasonable cost (i.e., wrecker services, locksmith/key service, glass repair, etc.)

## COURTESY CARE, WHICH APPLIES FOR 3 YEARS/36,000 MILES, PROVIDES:



Basic Care services



Free fuel delivery



Free locksmith/key service (when keys are lost on the road or locked inside)



Free non-warranty towing



Free flat tire change service



Free jump start.

\*Roadside Assistance membership is free. Some services may incur costs. Courtesy Care is available to retail, retail lease and corporate lease customers operating 1994 and newer Chevrolet vehicles for a period of 3 years/36,000 miles, whichever comes first. All Courtesy Care services' associated costs must be prearranged by Chevrolet Roadside Assistance or dealer service management and must be driver-initiated. Basic Care and Courtesy Care are not part of or included in the coverage provided by the New Vehicle Limited Warranty. Chevrolet reserves the right to modify or discontinue Basic Care and Courtesy Care at any time. See dealer for complete details of the Chevrolet Roadside Assistance Program.

## ADDITIONAL INFORMATION

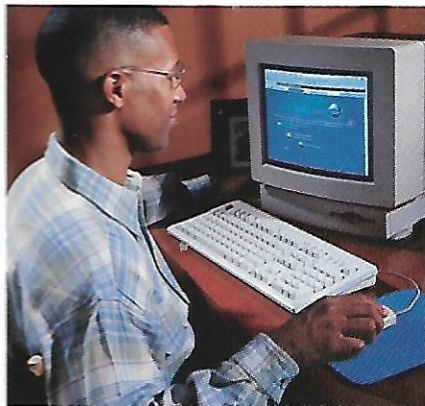

### PLEASE CONTACT US ...

For any additional information on 1998 Chevrolet car or truck products, call 1-800-950-2438 or visit us on the Internet at <http://www.chevrolet.com>

### CUSTOMER ASSISTANCE CENTER.

The Chevrolet Customer Assistance Center has a special toll-free number: 1-800-222-1020. It puts you in contact with experts who can handle any product or service questions you may have with your new Chevy Express or Chevy Van.

### SMARTLEASE BY GMAC.

SMARTLEASE by GMAC makes it easy to enjoy the excellence of Chevy Express or Chevy Van. With SMARTLEASE, qualified customers can be approved in about one hour, and you'll enjoy low SMARTLEASE monthly payments. Plus, SMARTLEASE offers you choices at the end of your lease.

You can either buy your Chevy Express or Chevy Van at a price guaranteed up



front, or return your van with no other obligations — providing the terms of the lease have been met. For more information about SMARTLEASE or any of the other quality GMAC financing options, see your Chevy dealer or call 1-800-32-SMART.

### TURN PLASTIC INTO STEEL WITH THE GM CARD®.

The GM MasterCard® with no annual fee (standard GM Card only) gives you an important financial advantage on your next purchase or lease of a GM vehicle. Use The GM Card® for purchases and you'll receive up to 5 percent of that purchase amount in GM Card Earnings. You can earn

as much as \$500 per Account Year, for a maximum of \$3,500 over a period of seven years.

Your GM Card Earnings are

over and above any other discount or incentive. To request your GM Card, call 1-800-8GM-CARD.



### THE GM MOBILITY PROGRAM FOR PERSONS WITH DISABILITIES.

We invite your inquiries about the GM Mobility Program for Persons with Disabilities. The program can reimburse you up to \$1,000 toward any aftermarket driver or passenger adaptive equipment you may require for your 1998 Chevy Express or Chevy Van, and can set up complete GMAC\* financing for you, too. The program can also provide you with free resource information such as area driver assessment centers and mobility equipment installers. See your Chevy dealer for more details or call this toll-free number for more information: 1-800-323-9935. Text telephone (TTY) users, call 1-800-833-9935.

\*Available to qualified applicants.

### UPDATED SERVICE INFORMATION.

Chevrolet regularly sends its dealers useful service bulletins about Chevrolet products. Chevrolet monitors product performance in the field. We then prepare bulletins for servicing our products better. Now you can get these bulletins, too. Ask your dealer or, for ordering information, call toll free: 1-800-551-4123.

### ASSEMBLY.

Chevrolet trucks are assembled by different operating units of General Motors, its subsidiaries or suppliers to GM worldwide. Chevrolet trucks incorporate thousands of components produced by different operating units of GM, its subsidiaries or suppliers to GM worldwide. We sometimes find it necessary to produce Chevrolet trucks with different or differently sourced components than originally scheduled. All such components have been approved for use in Chevrolet trucks and will provide the quality of performance associated with the Chevrolet name. Since some options may be unavailable when your vehicle is assembled, we suggest that you verify that your vehicle includes the equipment you ordered or, if there are changes, that they are acceptable to you.

### ENGINES.

Chevrolet trucks are equipped with engines produced by different operating units of GM, its subsidiaries or suppliers to GM worldwide.

### CORROSION PROTECTION.

Chevrolet trucks are designed and built to resist corrosion. All body sheet-metal components are warranted against rust-through corrosion for 6 years/100,000 miles (whichever comes first). Application of additional rust-inhibiting materials is not required and none is recommended. See your Chevrolet dealer for terms of this limited warranty.

### A WORD ABOUT THIS BROCHURE.

We have tried to make this brochure as comprehensive and factual as possible. We reserve the right, however, to make changes at any time, without notice, in prices, colors, materials, equipment, specifications, models and availability. Since some information may have been updated since the time of printing, please check with your Chevrolet dealer for complete details.

### GM PROTECTION PLAN.

The available GM Protection Plan offers service protection in addition to that provided by GM's New Vehicle Limited Warranty. Ask your dealer about it. Coverage available only in the U.S. and Canada.

Chevrolet, the Chevrolet Emblem, General Motors, GM, the GM Emblem, Chevy Van, TheftLock, Delco, ETR, Passlock and Solar-Ray are registered trademarks of the General Motors Corporation. Chevy, Chevy Express and Vortec are trademarks of the General Motors Corporation. GMAC and SMARTLEASE are registered trademarks of the General Motors Acceptance Corporation. "Scotchgard" is a registered trademark of 3M. TM & © Marvel Characters, Inc. All rights reserved.

© 1997 General Motors Corp. All rights reserved.



# DIMENSIONS, MODELS AND WHEELS.

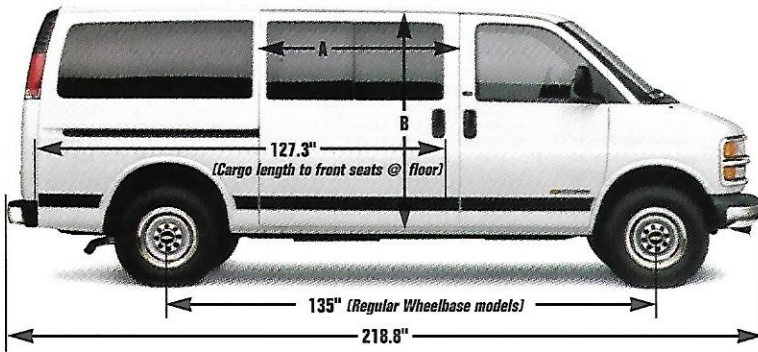
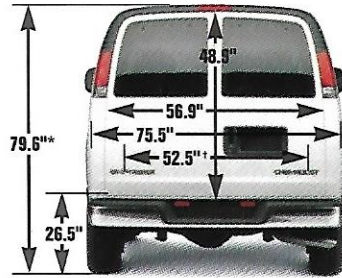
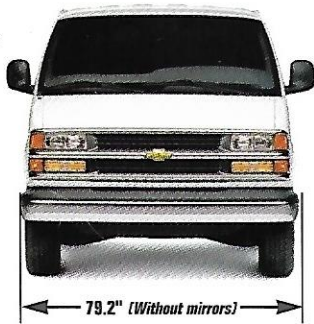
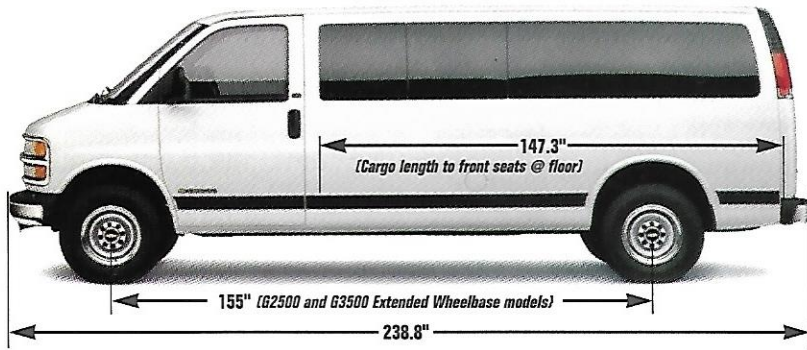

DOOR TYPE	A	B
Sliding	40.9"	49.2"
60/40 Split	46.7"	48.8"

\*G1500 with 7100-lb. GVWR.  
†Width between wheelhousings.

## DIMENSIONS

INTERIOR DIMENSIONS (IN.)	REGULAR WHEELBASE	EXTENDED WHEELBASE
Height of rear opening	48.9	48.9
Width of rear opening @ floor	56.9	56.9
Width of rear opening @ belt	56.9	56.9
Floor-to-ceiling height	53.8	53.8
Maximum cargo floor width	73.1	74.1
Cargo floor width @ wheelwells	52.5	52.5
Load floor length to front seat <sup>1</sup>	127.3	147.3
<b>CARGO VOLUME (CU. FT.)</b>		
All center- and rear-row seats removed <sup>2</sup>	267.3	316.8

<sup>1</sup> Measured at beltline. <sup>2</sup> Measured floor to roof.

## MODEL SELECTOR

MODEL	WHEELBASE (IN.)	GVWR (LBS.)	TRIM AVAILABILITY	
			BASE	LS
Chevy Express				
— G1500	135	7100	S	O
— G2500	135	8600	S	O
— G3500	135	9500	S	O
Chevy Express Extended				
— G2500	155	8600	S	O
— G3500	155	9500	S	O
Chevy Van with Converter Package <sup>1</sup>				
— G1500	135	7100	S	—
— G2500	135	8600	S	—
— G3500	135	9500	S	—
Chevy Van Extended with Converter Package <sup>1</sup>				
— G2500	155	8600	S	—
— G3500	155	9500	S	—

<sup>1</sup> With RPO YF7 Converter Package — available to Chevrolet Quality-Approved Converters.



### ARGENT-PAINTED STEEL WHEEL.

Includes black center cap. Standard with Chevy Express Base trim and Chevy Van. Size: 15" x 6" with G1500, 16" x 6.5" with 2500/G3500.



### ARGENT-PAINTED STEEL WHEEL WITH BRIGHT TRIM RING.

Includes bright center cap. Optional (RPO P06) on Base Chevy Express, included with optional LS trim. Size: 15" x 6" with G1500, 16" x 6.5" with G2500/G3500.



### CAST-ALUMINUM WHEEL.

Optional (RPO N90) for G1500 Chevy Express and G1500 Chevy Van with RPO YF7 Conversion Package. Size: 15" x 7".



### CHROME-PLATED STEEL WHEEL WITH CHROME CENTER CAP.

Optional (RPO N83) for G1500 Chevy Express models and G1500 Chevy Van with RPO YF7 Conversion Package. Size: 15" x 7".

## PREFERRED EQUIPMENT GROUPS

These convenient option packages make it easy to tailor a new Chevy Express or Chevy Van conversion van to your specifications.

CHEVY EXPRESS TRIM LEVEL PREFERRED EQUIPMENT GROUP	BASE		LS	
	1SA	1SB	1SC	1SD
Standard Body	■	■	■	■
Convenience Group: Power Door Locks and Power Windows		■	■	■
Convenience Group: Tilt-Wheel™ Adjustable Steering Column and Electronic Speed Control with Resume Speed		■	■	■
LS Trim			■	■
Air Conditioning: Front and Rear, with Dual Controls, includes Rear Heater				■
Glass: Solar-Ray Deep-Tinted				■
Remote Keyless Entry				■
Mirrors, Exterior: Dual Black Fold-Away, Electric Remote Control with Defog Feature				■
Mirrors, Visor: LH and RH, Illuminated				■
Steering Wheel, Leather-Wrapped				■

CHEVY VAN TRIM LEVEL¹ PREFERRED EQUIPMENT GROUP	BASE		
	1SC	1SD	1SF
Standard Body	■	■	■
YF7 Conversion Package (includes Front Air Conditioning, 124-Amp Alternator, Chrome Grille with Composite Headlamps, Chrome Front and Rear Bumpers, Power Door Locks and Windows, Tilt-Wheel™ Adjustable Steering Column and Electronic Speed Control with Resume Speed, ETR AM/FM Stereo with Seek-Scan, Cassette Player and Digital Clock, Dual Direct-Control Outside Rearview Mirrors and 60/40 Split Rear Side Cargo Door)	■	■	■
Glass: Solar-Ray Deep-Tinted		■	■
Glass: Swing-Out Rear Side Cargo Door and Rear Doors		■	■
Mirrors, Exterior: Dual Black Fold-Away, Electric Remote Control with Defog Feature		■	■
Mirrors, Visor: LH and RH, Illuminated		■	■
AM/FM Stereo with Seek-Scan, Automatic Tone Control and Cassette Player²		■	■
Steering Wheel, Leather-Wrapped		■	■
Antenna, Power			■
Remote Keyless Entry			■
Wheels: Cast-Aluminum (G1500 Series only)			■

■ — Included in Preferred Equipment Group.

¹ With RPO YF7 Conversion Package. For information about Chevy Cargo Van models equipped for commercial use and G3500 Commercial and RV Cutaway Van models, please see your Chevy Truck dealer. ² May upgrade.

## STANDARDS AND OPTIONS

CHEVY EXPRESS  
BASE LS (w/YF7\*)  
CHEVY VAN

**NOTE:** Some individually available options listed may be included in, or be ordered only with, specific Preferred Equipment Groups. Please see the Preferred Equipment Groups chart for content and availability. Some additional ordering restrictions may apply. Please see your salesperson for details.

### SEATING

#### SEAT STYLES

Front bucket seats, reclining adjustable high-back, driver and front-passenger; with integral head restraints and padded door panel armrests — Vinyl trim	S	-	-¹
Front bucket seats, reclining adjustable high-back, driver and front-passenger; with integral head restraints, padded door panel armrests, inboard armrests and map pockets on seatbacks — Custom Cloth trim	O	S	-
Rear bench seat(s) (Chevy Express only): 3-passenger, with RH pivoting armrest (one, two or three seats are provided, depending on model configuration selected; a 4-passenger, rearmost-row seat is also included with 12- and 15-passenger seating) See page 17 for availability by series — Vinyl trim — Custom Cloth trim	S O	- S	- -
Seat adjuster, power: — driver 6-way — passenger 6-way	O² O³	O O⁴	- -

### INTERIOR FEATURES

Air bags, Next Generation driver and front-passenger (Next Generation front-passenger air bag will be available interim 1998 model year.)	S	S	S
Air conditioning, front (with CFC-free refrigerant)	S	S	S
Air conditioning, front and rear (with CFC-free refrigerant), includes dual controls, rear heater and 124-amp alternator	O	O	-
Child comfort guides; outbound seating positions	S	S	-
Convenience Group: power door locks and power windows	O	S	S
Convenience Group: Tilt-Wheel™ Adjustable Steering Column and electronic speed control with Resume Speed	O	S	S
Floor covering: embossed black vinyl, full-width mat — entire floor area and front wheelhousings — full-floor carpeting with mats	S O	- S	-¹ -¹
Glass, Solar-Ray, light-tinted	S	S	S
Glass, Solar-Ray, deep-tinted, in rear side windows and rear door windows	O⁵	O	O⁵
Glass, window (in addition to windshield and front doors) — complete body — none — rear doors only, fixed or swing-out — rear doors and side cargo door, fixed or swing-out	S - - -	S - - -	O S O O



	CHEVY EXPRESS		CHEVY VAN
	BASE	LS	(w/YF7*)

#### INTERIOR FEATURES (contd.)

Interior trim panels			
— composite	S	-	- <sup>1</sup>
— composite with Custom Cloth on LH side behind driver seat	-	S	- <sup>1</sup>
Headliner: color-keyed cloth, full width			
— full-length	S	S	-
Heater, rear	O <sup>6</sup>	O <sup>6</sup>	-
Lighting: three dome lamps, with defeat switch and front door-actuated switches and underhood lamp	S	S	S
Lighting, auxiliary: includes reading lights, stepwell lights (front and side doors) and retractable reel-type underhood lamp	O	S	O
Locking system: single two-sided key for ignition and all doors	S	S	S
Remote Keyless Entry	-	O	O
Scotchgard™ Protector: on floor carpeting and Custom Cloth seats and trim	O <sup>7</sup>	S	- <sup>1</sup>
Sliding shoulder safety belt anchors; driver and right front passenger	S	S	S
Sunshades: color-keyed, LH and RH with full map strap on LH side	S	S	S
— with LH and RH illuminated vanity mirrors	-	O	-

#### INSTRUMENT PANEL/CONTROLS

Ashtray (lighted) and cigarette lighter	S	S	S
Cup holders, dual: in instrument panel console	S	S	S
Gauges, analog type: includes speedometer, trip odometer, fuel level, voltmeter, engine temperature and oil pressure	S	S	S
Heater and defroster: with front side-window defoggers	S	S	S
Passlock® vehicle theft-deterrent system	S	S	S
Power outlet, one auxiliary, 12-volt electric: covered	S <sup>4</sup>	S <sup>4</sup>	S <sup>4</sup>
Storage bin, lighted: in engine cover extension	S	S	S
Steering wheel: with mini-module air bag	S	S	S
Steering wheel, leather-wrapped: with mini-module air bag	O	O	O
Warning tone, headlamps-on	S	S	S

#### SOUND SYSTEMS BY DELCO ELECTRONICS

**NOTE:** All sound systems include a Delco Electronics ETR (Electronically Tuned Receiver) AM/FM stereo, seek-scan and digital clock.

ETR AM/FM stereo with four speakers	S	S	-
ETR AM/FM stereo with cassette player and four speakers	O	O	S
ETR AM/FM stereo with cassette player: includes automatic tone control, speed-compensated volume, TheftLock, eight speakers and power antenna	O	O	O

#### SOUND SYSTEMS BY DELCO ELECTRONICS (contd.)

ETR AM/FM stereo with compact disc player: includes automatic tone control, speed-compensated volume, TheftLock, eight speakers and power antenna	O	O	O
ETR AM/FM stereo with cassette player and compact disc player: includes automatic tone control, speed-compensated volume, tape Search and Repeat feature, TheftLock, eight speakers and power antenna	O	O	O
Antenna, power	O <sup>9</sup>	O <sup>9</sup>	O

#### EXTERIOR FEATURES

Air dam, front (G1500 Series only)	S	S	S
Body panels, two-side galvanized (except roof)	S	S	S
Bumper, front:			
— painted Argent	S	-	-
— chrome, with step pad	-	S	S
Bumper, rear: with entry-assist step			
— painted Argent	S	-	-
— chrome	-	S	S
Daytime Running Lamps (DRL)	S	S	S
Door(s), body-side: with child safety lock			
— 60/40 swing-out	S	S	S
— sliding (no-cost option)	O	O	O
Doors, rear panel, dual: with child safety lock	S	S	S
Grille, composite: painted Dark Argent, with single rectangular halogen headlamps	S	-	-
Grille, chrome: with dual composite headlamps	-	S	S
Mirrors, exterior:			
— dual, black, fold-away	S	-	-
— dual, black, electric, fold-away with defog feature	O <sup>10</sup>	O	S
Moldings, body-side: graphite	-	S	-
Wipers, windshield: with intermittent feature and pulse washers	S	S	S

#### CHASSIS FEATURES

Alternator, 100-amp	S	S	-
Alternator, 124-amp	O <sup>11</sup>	O <sup>11</sup>	S
Battery, heavy-duty: 600cca	S <sup>12</sup>	S <sup>12</sup>	S <sup>12</sup>
Brake system, power-assisted: front disc/rear drum with 4-wheel ABS	S	S	S
Cold Climate Package: includes engine block heater	O <sup>13</sup>	O <sup>13</sup>	O <sup>13</sup>
Differential, locking rear	O	O	O
Exhaust system, aluminized stainless-steel	S	S	S
Fuel tank: 31-gallon capacity	S	S	S
Springs, heavy-duty: front coil and 2-stage multi-leaf rear	S	S	S
Steering, power: speed-sensitive EVO (Electronic Variable Orifice)	S	S	S

	CHEVY EXPRESS		CHEVY VAN
	BASE	LS	(w/YF7*)

#### CHASSIS FEATURES (contd.)

Trailing special equipment, heavy-duty: includes weight-distributing trailering hitch platform and 8-lead trailer wiring harness	O	O	O
--	---	---	---

#### TIRES

G1500 Series:			
P235/75R-15 blackwall	S	S	S
P235/75R-15 whitewall	O	O	O
P235/75R-15 white outline-lettered	O	O	O
G2500 Series:			
LT225/75R-16E blackwall	S	S	S
G3500 Series:			
LT245/75R-16E blackwall	S	S	S
Spare tire, full-size: with steel wheel, mounted under rear floor	S	S	S

S — Standard with trim level. O — Optional.

\*RPO YF7 is the order code for the Chevy Van Conversion Package (available to Quality-Approved Converters only). Equipment availability may vary for Chevy Van RPO YF7 Conversion Package. See your Chevy Truck dealer for details.

**1** Seating, floor covering and trim panels supplied by independent converter. **2** Requires optional Custom Cloth bucket seats. **3** Requires optional Custom Cloth bucket seats and power driver-seat adjuster. **4** Requires optional power driver-seat adjuster. **5** Requires rear side-door and rear-door glass. **6** Included with optional front and rear air conditioning. **7** Requires optional Custom Cloth bucket seats and optional carpeting. **8** On lighter receptacle can serve as second power outlet. **9** Requires standard AM/FM stereo with cassette player, included with optional uplevel sound system (includes automatic tone control). **10** Requires RPO ZQ2 Convenience Group (includes power door locks). **11** Included on G2500 and G3500 Series and with optional rear air conditioning. **12** Two batteries @ 600cca each with optional 6.5L Turbo-Diesel engine. **13** Not available with 6.5L Turbo-Diesel V8 engine.

**NOTE:** The Chevy Express and Chevy Van trim features indicated reflect only a portion of the total content of each trim level. See your Chevy Truck dealer for complete listings.

## CHEVY EXPRESS COLOR AND TRIM.

With a choice of Custom Cloth or vinyl trim, plus a wide selection of exterior paint colors, you can personalize your Chevy Express just the way you want it.

### COLOR AVAILABILITY

EXTERIOR COLORS	INTERIOR COLORS		
	NAVY	NEUTRAL	GRAY
Light Autumnwood Metallic		■	
Medium Blue-Green Metallic		■	■
Dark Brown Metallic		■	■
Dark Copper Metallic		■	■
Medium Storm Gray Metallic	■		■
Dark Carmine Red Metallic		■	■
Medium Madrid Red Metallic		■	■
Silvermist Metallic	■		■
Summit White	■	■	■

**NOTE:** A Red interior is available in Chevy Van with RPO YF7 Conversion Package only.

#### CUSTOM CLOTH TRIM

Chevy Express only; included with LS trim, optional with Base trim.



Navy



Neutral



High-back bucket seat shown in Gray Custom Cloth.

#### VINYL TRIM

Included with Base trim.



Navy



Gray

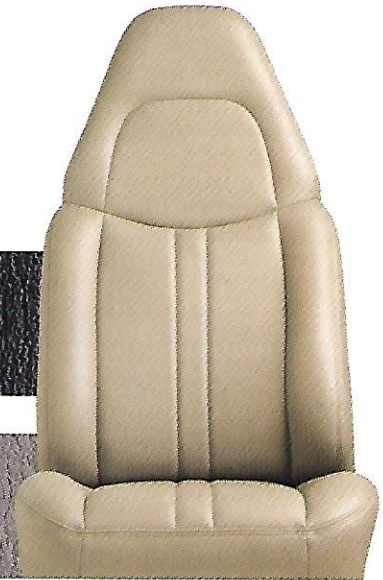

Standard high-back bucket seat shown in Neutral Vinyl.



*Light Autumnwood Metallic*



*Dark Carmine Red Metallic*



*Medium Blue-Green Metallic*



*Medium Madrid Red Metallic*



*Dark Brown Metallic*



*Silvermist Metallic*



*Dark Copper Metallic*



*Summit White*



*Medium Storm Gray Metallic*



**CHEVY TRUCKS**