



2020 RAM PROMASTER CITY



FROM CARGO TO PEOPLE, *THIS CITY GETS IT RIGHT.*



CARGO VAN



WAGON



CARGO VAN AND WAGON: PURE CAPABILITY, EVERYWHERE YOU LOOK.

This is Ram ProMaster City® at a glance: one well-thought-out body design that capably meets multiple assignments and uses—and with commercial-grade capability. One powertrain that delivers remarkable performance, impressive economies of scale—and a host of best-in-class advantages. Two proven and practical models—offering nearly unlimited potential for businesses, organizations, shuttles and families. ProMaster City models feature a nimble 2.4L Tigershark® MultiAir®2 in-line four-cylinder mated to a

class-exclusive 9-speed automatic transmission^{1*}—a working powerhouse that delivers best-in-class horsepower¹, best-in-class torque¹ and best-in-class highway fuel economy² (Cargo Van)—and backed by top-tier rankings that include best-in-class payload¹ and unsurpassed towing¹ (Cargo Van), topped off with best-in-class GVWR¹ for all models. If you're looking for a commercial-grade vehicle that's versatile, tough and resilient—your review here is just the start. Spec out your Ram ProMaster City model of choice anytime at ramtrucks.com/promastercity

*All disclosures can be found on the last page.

IT ALL GETS DOWN TO *STANDING OUT.*

**AMERICA'S
MOST EFFICIENT
WORK VAN³**



CARGO VAN **BEST-IN-CLASS**

28 MPG HWY FUEL ECONOMY²
2.4L TIGERSHARK® MULTIAIR^{®2} I-4

BEST-IN-CLASS

178 HP 174 LB-FT OF TORQUE¹
2.4L TIGERSHARK MULTIAIR² I-4

CLASS-EXCLUSIVE

9-SPEED
AUTOMATIC TRANSMISSION¹

CLASS-EXCLUSIVE

**BI-LINK REAR
SUSPENSION¹**
OUTSTANDING COMFORT & STABILITY

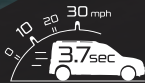

0 - 30 MPH IN 3.7 SEC⁴

**ENGINE OIL CHANGE INTERVALS
UP TO 10,000 MILES**

CARGO VAN **UNSURPASSED**

2,000-LB
MAXIMUM TOWING¹

5YR/60,000MI⁵
POWERTRAIN LIMITED WARRANTY

DESIGNED TO EXCEL WHERE IT REALLY COUNTS.



CARGO VAN **BEST-IN-CLASS**

131.7-CU FT

CARGO CAPACITY¹
(BEHIND FIRST ROW)

CARGO VAN **BEST-IN-CLASS**

1,890-LB

MAXIMUM PAYLOAD¹

ACCOMMODATING
OVER 4 FT
BETWEEN WHEEL WELLS

AVAILABLE
RAM TELEMATICS™
WITH TOUCHSCREEN DISPLAY

CONVENIENT
60/40 SPLIT REAR DOORS

Doors open 180 degrees.
Designed to accept a standard pallet.

STANDARD
UCONNECT® 3 WITH
5-INCH TOUCHSCREEN DISPLAY



RAM PROMASTER CITY[®]
A MODEL OF EFFICIENCY



CARGO VAN

BEST-IN-CLASS

28 MPG HWY FUEL ECONOMY²

THE BEST-IN-CLASS ADVANTAGES JUST KEEP ROLLING IN. When the starting point of your search for a commercial-grade Cargo Van is best-in-class highway fuel economy,² you know things are looking good. Happily, America's Most Efficient Work Van³ makes it even better. Along with that highway fuel economy figure are best-in-class stats for horsepower,¹ torque¹

and GVWR (it's 5,395 lb),⁶ as well as a big GCWR of 5,900 lb.⁶ Best-in-class advantages continue, with payload (up to 1,890 lb)¹ and cargo capacity behind the first row (of 131.7 cu ft)¹—about the volume of three washer/dryer sets. Also, with an accommodating 48.4 inches between the wheel wells—perfect for a pallet—Ram ProMaster City[®] proves itself, time after time.

THE RIGHT POWERTRAIN FOR THE CITY.



CLASS-EXCLUSIVE 9-SPEED AUTOMATIC TRANSMISSION!

- ▶ Equipped with Electronic Range Select (ERS), an electromechanical gear selection system that provides you with manual shift control of the transmission
- ▶ A wide 9.79 ratio spread brings outstanding launch characteristics and smooth, nearly indecipherable transfer between gears
- ▶ Shorter mid-range gears ensure quick transitions, and higher gears—7th, 8th and 9th transitions—relate to lower engine speeds
- ▶ High efficiency in all gears and speeds thanks to nested carriers, dog clutches and advanced hydraulic control unit architecture

2.4L TIGERSHARK® MULTIAIR®2 I-4

- ▶ **BEST-IN-CLASS** HORSEPOWER **178 HP¹** @ 6,400 rpm
- ▶ **BEST-IN-CLASS** TORQUE **174 LB-FT¹** @ 3,800 rpm
- ▶ 3.7 seconds from a full stop to 30 mph⁴
- ▶ Smart pulse-width modulation technology on the alternator and fuel pump helps contribute to operating efficiency
- ▶ Individual oil squirters help keep internal temperatures in the ideal range
- ▶ Position of the exhaust manifold helps minimize noise in the engine compartment
- ▶ Runs on 87-octane gasoline
- ▶ 5-Year/60,000-Mile Powertrain Limited Warranty⁵



An aerial, top-down view of a city street. The street is filled with cars, some parked and some in motion. Buildings line both sides of the street. A dark, semi-transparent banner is overlaid across the center of the image, containing the text 'RAM PROMASTER CITY' in red and 'CAPABILITY DELIVERED' in white. The overall tone is dark and professional.

RAM PROMASTER CITY[®]
CAPABILITY DELIVERED

BEST-IN-CLASS CARGO CAPACITY **131.7 CU FT.**¹
(BEHIND FIRST ROW)



BEST-IN-CLASS MAXIMUM PAYLOAD **1,890 LB.**¹



**OVER
4 FT**



**ENOUGH SPACE FOR
THE REAL WORLD.**

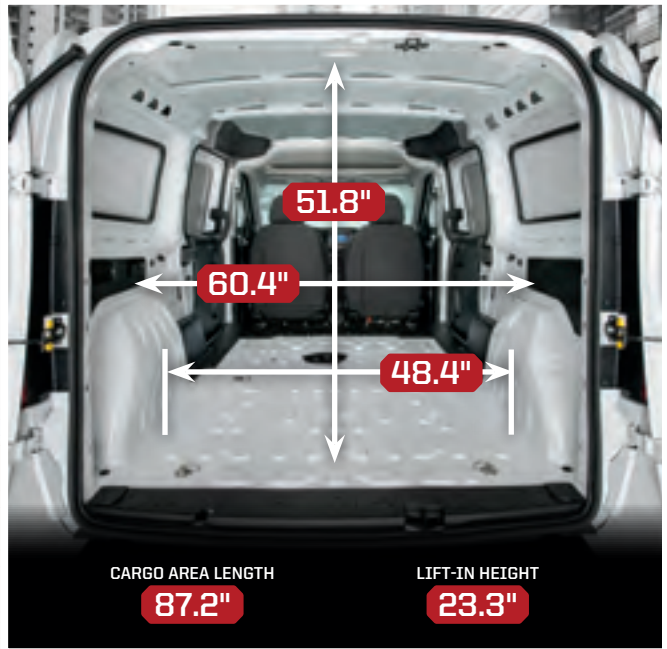

PRACTICAL. PURPOSEFUL. PROFICIENT. From the first sketch on the design board, the focus was threefold: make it big. Make it user-friendly. Make it versatile. Which is why you'll find an easy-to-load floor height, a huge interior made for customized upfits and near-vertical side walls that welcome aftermarket shelving. Engineered and built for real-world needs, Ram ProMaster City® Cargo Van leaves it all up to you. You know what you need to succeed—and this adaptable design is ready for it.

ROOF CAPACITY *THAT INCREASES YOUR CAPABILITIES.*



150-LB⁷

ROOF WEIGHT CAPACITY





Shown with aftermarket upfit.

UPFITS AND PARTITIONS: *DIVIDE AND CONQUER.*



OPEN TO CABIN Standard on Tradesman® Cargo Van and SLT Cargo Van



PARTITION Available for Tradesman Cargo Van and SLT Cargo Van



PARTITION WITH WINDOW Available for Tradesman Cargo Van and SLT Cargo Van

DESIGN LATITUDE *OPENS NEARLY EVERY POSSIBILITY.*



IT'S MADE TO BE WHATEVER YOU MAKE OF IT. Take a look, make some choices—and grow your business. The nearly vertical side walls are ideal for aftermarket shelving. The low, flat floor and adaptable rear doors simplify

the transformation of this Cargo Van into a mobile workshop. The spacious interior accommodates volumes of cargo and equipment—including pallets. So use your imagination, because this partner is your blank canvas.

Shown with aftermarket upfit.

THE MECHANICS OF *STRENGTH AND CAPABILITY.*

BEST-IN-CLASS GVWR¹: SUPPORT FROM TWIN-TUBE STRUTS, COIL SPRINGS AND UNIBODY FRAME

Our large-diameter, twin-tube hydraulic MacPherson struts (52 mm) work with outstanding unibody frame strength—all contributing to the best-in-class Gross Vehicle Weight Rating¹. We also added GVWR-tuned, high-performance stamped-steel, clamshell-sectioned control arms, steel crossmembers, specifically tuned springs, a solid 26-mm-diameter stabilizer bar with cast iron knuckles and large coil springs. Maximum performance gives you formidable capability, nimble maneuverability and a comfortable ride.

FRAME STRENGTH The body-frame integral (unibody) design includes an integrated frame, boxed frame components, multiple crossrails and a robust suspension. The engineering gives Cargo Van best-in-class payload up to 1,890 lb¹, unsurpassed towing up to 2,000 lb¹, best-in-class GVWR of 5,395 lb¹⁻⁶ and a Gross Combined Weight Rating (GCWR) of 5,900 lb⁶.

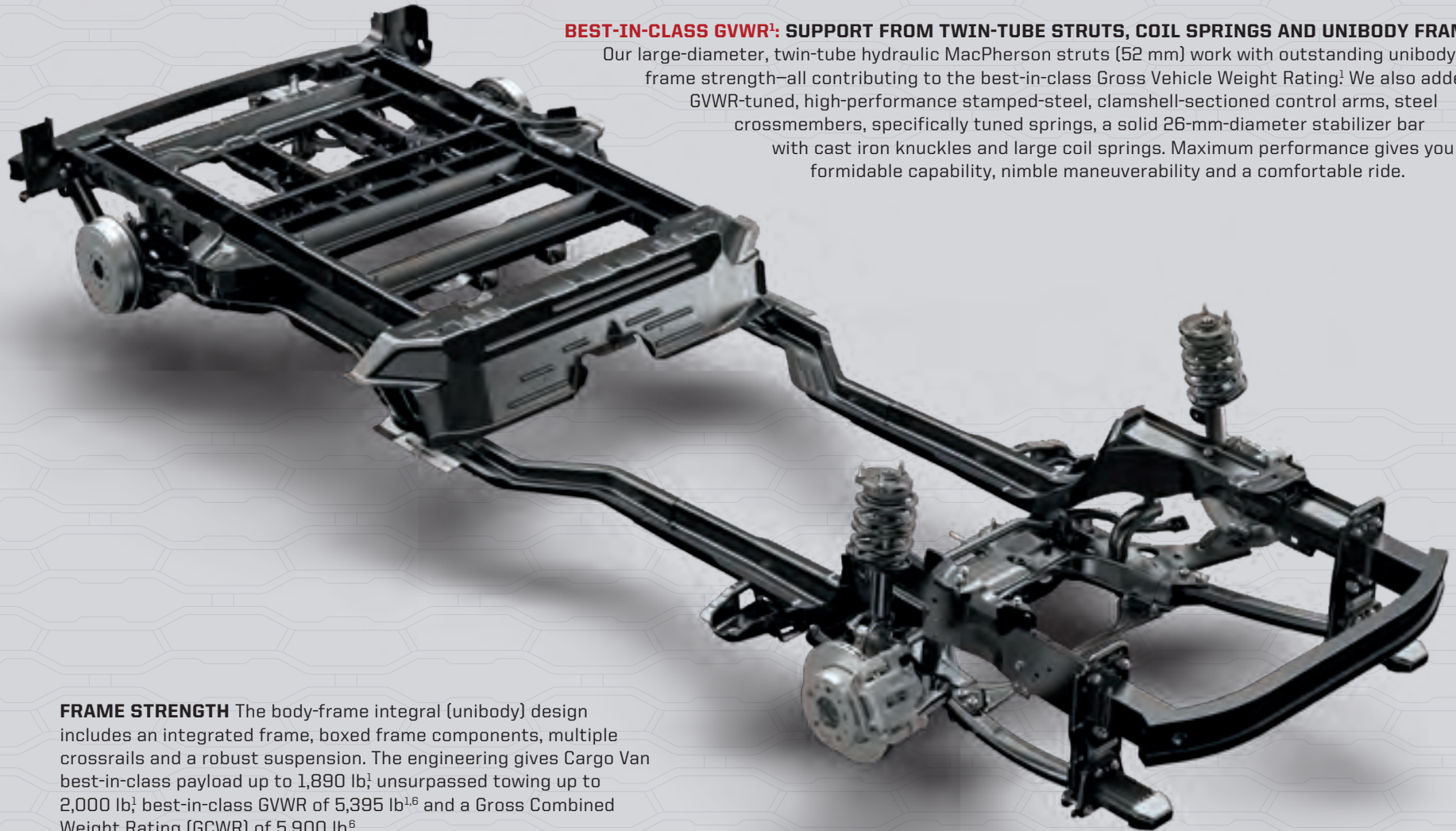

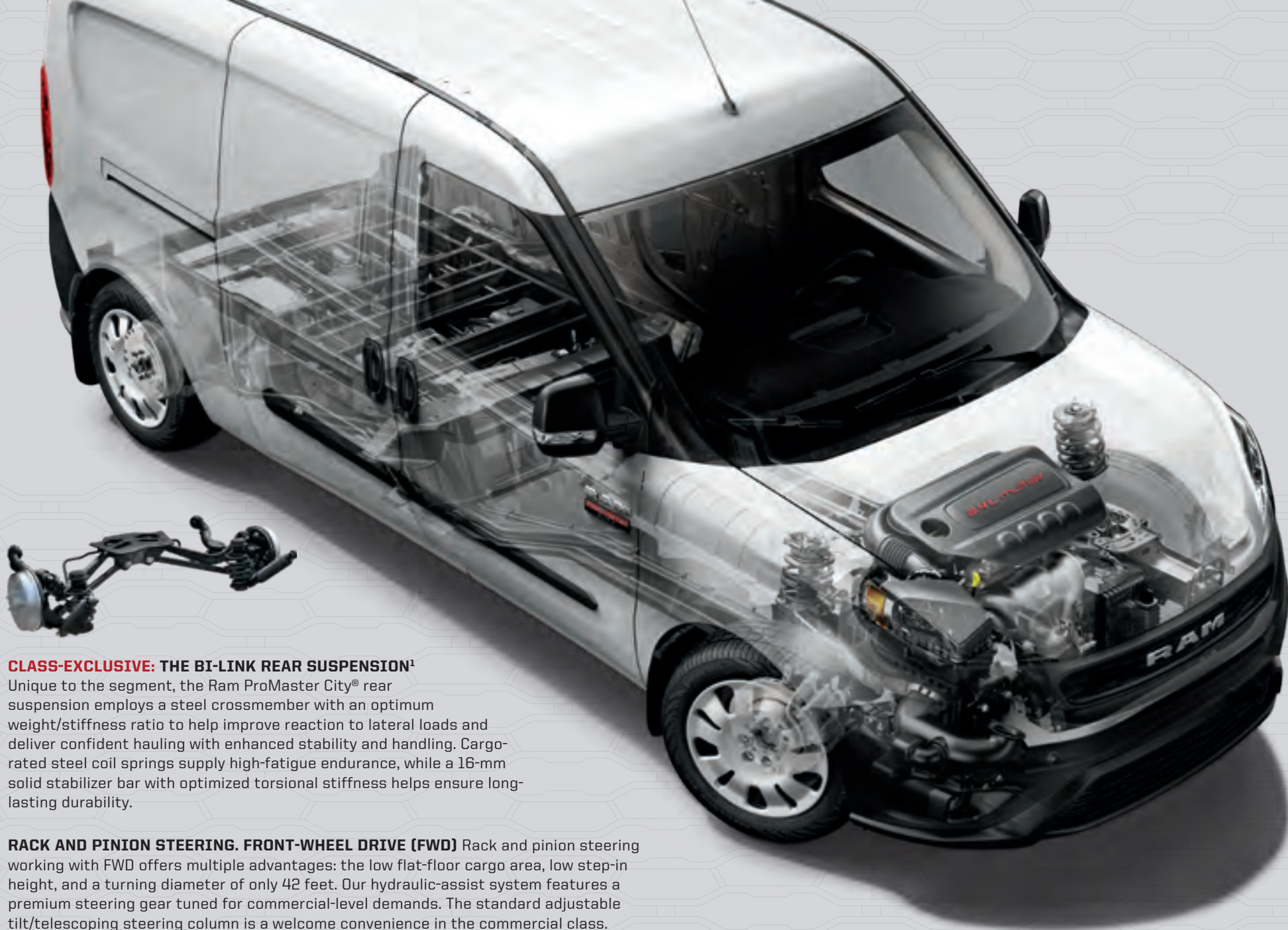

CLASS-EXCLUSIVE: THE BI-LINK REAR SUSPENSION¹

Unique to the segment, the Ram ProMaster City[®] rear suspension employs a steel crossmember with an optimum weight/stiffness ratio to help improve reaction to lateral loads and deliver confident hauling with enhanced stability and handling. Cargo-rated steel coil springs supply high-fatigue endurance, while a 16-mm solid stabilizer bar with optimized torsional stiffness helps ensure long-lasting durability.

RACK AND PINION STEERING. FRONT-WHEEL DRIVE (FWD) Rack and pinion steering working with FWD offers multiple advantages: the low flat-floor cargo area, low step-in height, and a turning diameter of only 42 feet. Our hydraulic-assist system features a premium steering gear tuned for commercial-level demands. The standard adjustable tilt/telescoping steering column is a welcome convenience in the commercial class.

THE MECHANICS OF *AGILITY AND CONTROL.*

YOU'RE ALWAYS RIDING WITH SAFETY AND SECURITY.

SEVEN STANDARD AIR BAGS⁸

INCLUDING CLASS-EXCLUSIVE DRIVER-SIDE KNEE AIR BAG^{1,8}

Few competitive vehicles in the class offer so many. Our system includes dual-stage driver and front-passenger air bags,⁸ side air bag⁸ inflatable curtains, front-seat-mounted thorax air bags,⁸ the class-exclusive driver-side knee air bag,^{1,8} dual front seat belt pretensioners and seat belt load limiters.

IN-FLOOR TIE-DOWN RINGS

In-floor tie-down rings (six on Cargo Van, four on Wagon) help secure cargo. They come as standard equipment on every model.

PARKVIEW[®] REAR BACK-UP CAMERA⁹

Standard on every model, the ParkView Rear Back-Up Camera⁹ automatically shows the rear scene in the Uconnect[®] 3 with 5-inch touchscreen display when in Reverse. The on-screen grid lines help when backing up to docks and trailers or into parking spaces.

PARKSENSE[®] REAR PARK ASSIST SYSTEM¹⁰

The available ParkSense Rear Park Assist System¹⁰ is an indispensable asset to help keep the driver alert to his or her surroundings. Activated under 8 mph when in Reverse, it detects objects up to 55 inches away (from the center of the rear fascia) and projects audible warnings that increase in intensity as the vehicle nears obstructions to the rear.



In-floor tie-down rings and seven standard air bags⁸

ELECTRONIC STABILITY CONTROL (ESC)¹¹

Every Ram ProMaster City[®] features one of the most comprehensive and advanced technologies for handling and maneuvering: the Electronic Stability Control (ESC)¹¹ system. This system integrates the Antilock Brake System (ABS) with a variety of All-Speed Traction Control technologies that enable all four corners of the vehicle to respond to lateral movement and the steering input from the driver. ESC¹¹ helps maintain

control under conditions such as wet or snow-covered roads, during tight turns and when the driver must utilize evasive maneuvers to help counter the unexpected. Calibrated to engine output, ESC¹¹ includes four-channel ABS, Brake/Lock Differential, a full-function All-Speed Traction Control system, Brake Assist, Trailer Sway Control,¹² Hill Start Assist and Electronic Roll Mitigation.

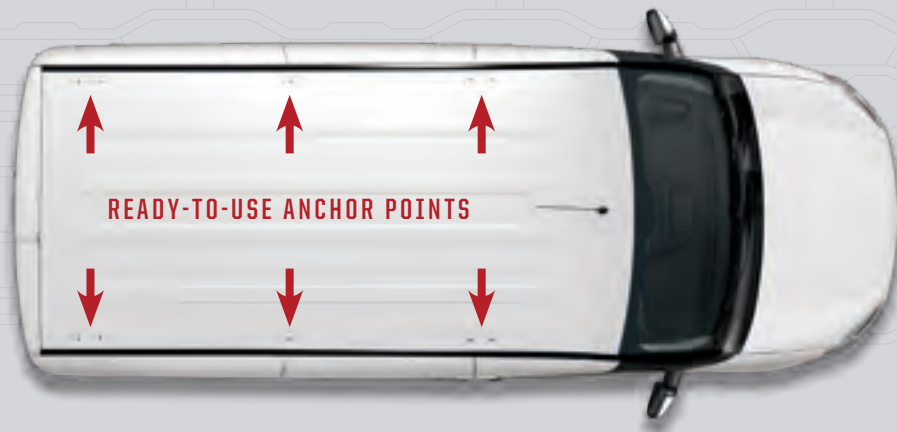

TOP-LEVEL CARGO MANAGEMENT

Convenient anchor points are in place for numerous aftermarket roof accessories—including available Roof Rails from Mopar®. Molded in color with a Silver finish, they carry a 150-lb⁷ max rating and will accommodate a variety of optional equipment. They're ideal for commercial applications, like ladders and similar large items. For a complete inventory, search mopar.com

A DESIGN THAT'S *JUST PLAIN SMART.*

SLEEK AERODYNAMIC EXTERIOR

Thoroughly wind tunnel-tested, Ram ProMaster City® delivers a super-low drag coefficient (CD)—it's a mere 0.30. While this enables a remarkably quiet interior, reducing wind resistance also acts as a major contributor to impressive efficiency.

INTELLIGENT FORWARD LIGHTING

Headlamps are high-mounted above common crash zones to help reduce damage (and costs) in the event of a collision. The system includes the Follow Me Home function, keeping the headlamps lit for a preset time after the engine is shut down to help illuminate your path in the dark.



EVEN IN BACK, WE'RE IN THE FOREFRONT.



Shown with aftermarket upfit.

60/40
REAR DOORS



OFFSET DOORS ARE DESIGNED TO BE SIMPLE AND CONVENIENT. From every standpoint, it just makes sense. With the larger of the rear doors positioned on the left, curbside work is easier, the cargo area is more accessible—and, most importantly, the worker avoids traffic in motion.



Uconnect®

TECHNOLOGY THAT CAN GET YOU THERE.

STAY IN TOUCH—AND IN THE KNOW. YOU NEED UCONNECT.® You need information, news and sports—without taking your eyes from the road or your hands off the wheel. You need directions to your next destination. Or you're just taking a break, and you need clear fidelity for ten minutes of uninterrupted "You Time." Uconnect can get you there—with Integrated Voice Command, exceptional audio and, depending on the radio you choose, navigation and points of interest. Available SiriusXM® Radio¹³ includes a one-year trial subscription.

(((SiriusXM®)))



UCONNECT 3 WITH 5-INCH DISPLAY

- ▶ AM / FM Stereo
- ▶ MP3 Capability with USB Input
- ▶ Integrated Voice Command
- ▶ Five-inch Color Touchscreen
- ▶ Four-speaker Sound System
- ▶ ParkView® Rear Back-Up Camera⁹



UCONNECT 3 NAV WITH 5-INCH DISPLAY

- All features of the Uconnect 3 with 5-inch display, plus:
- ▶ GPS Navigation
 - ▶ Points-of-interest Accessibility
 - ▶ Turn-by-turn Navigation

MEASURE PRODUCTIVITY *EVERY DRIVEN MILE.*

AVAILABLE RAM TELEMATICS™ A COMPREHENSIVE SET OF DIAGNOSTICS FOR YOUR RAM PROMASTER CITY®. Scalable to fleets of all sizes, factory-installed and backed by a 3-Year/36,000-Mile Basic Limited Warranty,¹⁴ available Ram Telematics monitors key performance metrics in real time—the power you need to transform your business.

Tracking nearly 100 separate mechanical functions—everything from accelerator pedal position to engine info such as coolant level and oil life monitoring—these detailed notifications help keep your Ram vehicle in top-notch condition, let your drivers make better decisions and, most importantly, contribute to dramatically increased uptime.



RAM TELEMATICS

POWERED BY VERIZON CONNECT

STAY ON TRACK BY KEEPING TRACK. Zero complexity plus total visibility equals 100% effectivity. This is vehicle status and history that add insight about driver behavior. Just a few of the many advantages:



VEHICLE DIAGNOSTICS

- ▶ Oil Life Monitoring
- ▶ Tire Pressure Monitoring
- ▶ Diagnostic Trouble Codes



VEHICLE PERFORMANCE

- ▶ Fuel Consumption
- ▶ Idling
- ▶ Odometer Readings



VEHICLE TRACKING

- ▶ GPS Location



DRIVER BEHAVIOR

- ▶ Speeding vs. Posted Speed Limit
- ▶ Hard Braking / Accelerating
- ▶ ABS / Stability Control Events



DRIVER SAFETY AND VEHICLE SECURITY

- ▶ Seat Belt Usage
- ▶ Air Bag[®] Deployment
- ▶ Unauthorized Vehicle Use



RAM TELEMATICS

POWERED BY VERIZON CONNECT

THE WELL-RUN BUSINESS: MORE VEHICLE UTILIZATION WITH LESS DOWNTIME.

The successful business is efficient, effective and up-to-date, and stays on top of any and all technologies that will help it run better. For fleets both large and small, the state-of-the-art available Ram Telematics™ is the way to continue getting the best from your Ram ProMaster City®.

Powered by Verizon Connect, available Ram Telematics gives you instant and real-time on-screen monitoring, provides complete visibility of fleet operations and helps reduce the total costs of ownership.

Activation is easy, with your choice of one-, three- and five-year plans. Online registration is fast and simple.

PROFITS ROLL WITH BOTTOM-LINE SAVINGS. Ram Telematics advantages in real-world numbers:

+15% IN PRODUCTIVITY

+20% IN VEHICLE UTILIZATION

-25% IN FUEL EXPENSES

-30% IN IDLE TIME

-10% IN MILEAGE DRIVEN

-15% IN OVERTIME

Source: "Total Cost of Fleet Operation—Benefits of Installing Telematics" Frost & Sullivan, 2018

Optimize your assets to their fullest and get the most from your Ram vehicle. Get more at ramtrucks.com/telematics



ONE PLAN. MULTIPLE DIVIDENDS.



RAM PROMASTER CITY[®]
MORE THAN JUST CARGO



RAM PROMASTER CITY® WAGON

THE WAGON THAT PUTS PEOPLE FIRST.



HUGE INNER SPACE. PERFECT FOR EXPLORING THE GREAT OUTDOORS. It's got everything a people-first vehicle should offer. Like sleek aerodynamic styling—with a roof design ready-made for adding on the fun stuff. Like a spacious and well-appointed interior—with dual side sliding doors that help make getting in and out a breeze. Like an intelligent 60/40 rear door design that promotes secure and convenient loading—curbside or beachside. Add towing rated up to 1,878 lb⁷ and you've got the just-right Wagon for people, pooches, parties and playtime.



LARGE ENOUGH FOR THE WHOLE CREW. The confined spaces of the traditional family vehicle are long gone. The area behind Passenger Wagon's upright second-row seats is 74.1 cu ft⁷; fold them down, and the space opens up to 101.7 cu ft⁷.

Properly secure all cargo. Animals should always be safely and properly secured while vehicle is in motion.

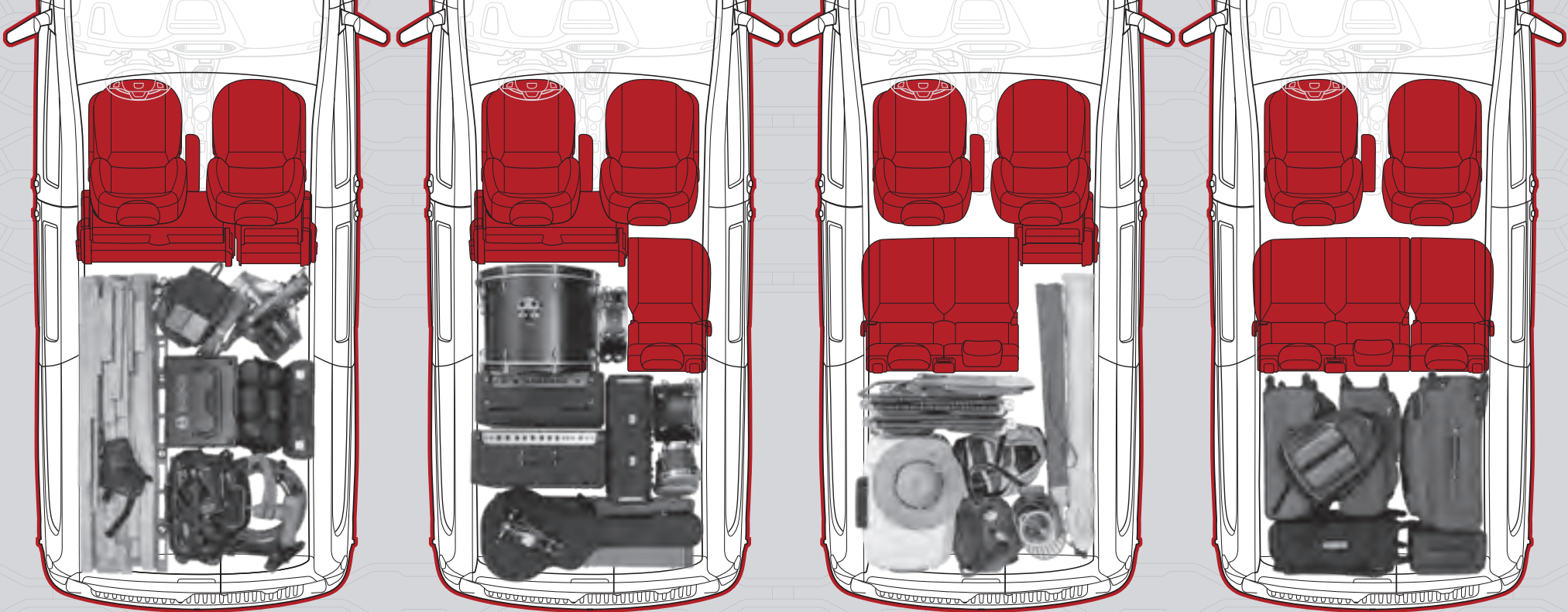

INSTANTLY ADAPTS TO NEARLY EVERY LIFESTYLE.

EACH FOLD IN THIS WAGON BRINGS NEW OPPORTUNITIES. Before we get into the mechanics of the seats themselves—that's on the next page—let's discuss just what this interior design allows you to do: it's pretty much anything. With rear seats folded, you've got a cavernous 101.7 cu ft⁷ of max

cargo room. At full five-person occupancy, you still have 74.1 cu ft⁷ of cargo room behind the second row of seats. The variations illustrated above reflect the designed-in adaptability that'll satisfy just about any lifestyle out there. So feel free to do your thing. We're ready for it.



STORAGE: ABUNDANT. SPACIOUS. CONVENIENT.

From the huge in-door pockets (with sculpted bottle holders) to specialized trays to oversized glove compartments, it's all here—even an overhead shelf, two 12-volt auxiliary power outlets, and USB port and connections to charge on-the-go electronics.

LONG AND SHORT HAULS. RIDE IN COMFORT.



AMPLE ROOM FOR PEOPLE AND CARGO. If you're totally demanding about interior comfort, quality and convenience, know this: we're comfortable with it. On every model, these front tubular seats feature spring suspensions and adjustable headrests with reclining seatbacks¹⁵ and super-durable fabrics.

Manual supports for the driver's seat and heated surfaces for both front seats are available. Rear seats feature innovative Fold-and-Tumble operation with up to nine configurations. Impressive storage, huge cargo room and comfort for everyone make this the Wagon of choice.

A TOTAL FOCUS TO MEET SPECIAL NEEDS.



JUST TAKE A SEAT. THIS RIDE IS JUST RIGHT. The true measure of adaptability is to satisfy challenging demands with dignity, grace and style. Count on Ram ProMaster City® and the FCA Driveability Program to help you achieve it.

Expansive side door openings provide huge, unimpeded access to the interior. The flat floor and big 60/40 split rear doors make wheelchair access and mounting apparatus simple. Standard in-floor D-rings (four on Wagon, six on Cargo Van) ensure secure anchoring—and incentives offered by the Driveability Program are pocketbook-friendly. Think comfort and operational ease—because our starting point was to make a van that's all about you.

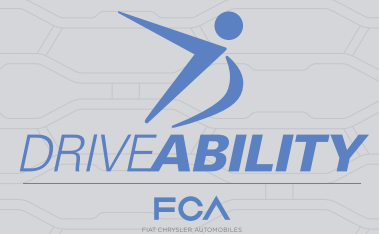

Shown with aftermarket upfit.

AUTHENTIC ACCESSORIES BY MOPAR®

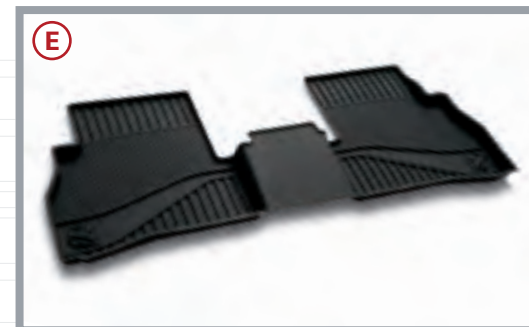

- A. LED Cargo-Area Lights
- B. Hitch Receiver¹⁶
- C. Molded Splash Guards
- D. All-Weather Floor Mats, First Row
- E. All-Weather Floor Mats, Second Row



AS THE OFFICIAL SERVICE, PARTS AND CUSTOMER CARE PROVIDER for the Ram Brand, only Mopar Parts and Accessories can ensure the proper fit, finish and functionality that make your Ram ProMaster City® the ideal vehicle for your needs. Why? It's simple: this is original equipment, engineered by the same people who designed your vehicle. They know it inside out, and that means you can customize it with exacting quality and complete confidence.

Mopar is also more than parts and accessories. We're here to help you properly maintain and care for your vehicle. Our certified technicians are trained to know your vehicle best, and our Mopar Express Lane service departments are set up to get you in and out quickly. From parts and accessories to expert service and more, always be sure to choose Mopar. Learn more at mopar.com

EXTEND YOUR *CAPABILITIES.*

RAM PROMASTER CITY® IS READY-MADE TO GIVE YOU MORE.

The roof on every model features six ready-to-use anchor points designed to perfectly fit the optional factory-installed Mopar® Side Roof Rails or the Mopar Three-Bar Utility Rack. Add available Mopar Adjustable Crossbars or many other accessories to fit your needs. Get more by learning more. Start at mopar.com



Three-Bar Utility Roof Rack (shown with PVC Carriers¹⁷)



Side Rails with Adjustable Crossbars and Roof-Mount Ski and Snowboard Carrier¹⁸

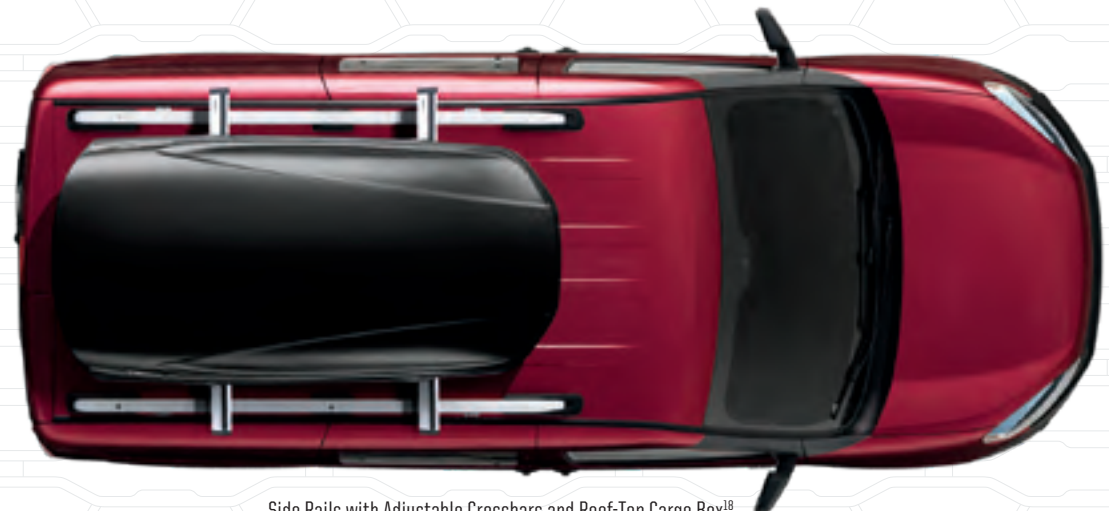

Side Rails with Adjustable Crossbars and Roof-Top Cargo Box¹⁸



RAM PROMASTER CITY[®]
CRAFTED TO EXCEL

2020 RAM PROMASTER CITY®
BUYER'S GUIDE

	Wagon	Wagon SLT	Tradesman® Cargo Van	Tradesman SLT Cargo Van
ENGINE / TRANSMISSION				
2.4L TIGERSHARK® MULTIAIR®2 I-4 ENGINE / 9-SPEED AUTOMATIC TRANSMISSION	•	•	•	•
MECHANICAL FEATURES				
ALTERNATOR – 160-amp	•	•	•	•
BATTERY – 700-amp, maintenance-free	•	•	•	•
BRAKES – Four-wheel antilock	•	•	•	•
FUEL TANK – 16-gallon	•	•	•	•
UPFIT INTERFACE CONNECTOR (included with Taxi Cab Package and RV-Ready Prep Package; limited availability)	O/P	O/P	O/P	O/P
EXTERIOR FEATURES				
BODYSIDE MOLDING – Black	•	•	•	•
BUMPERS – Front and rear, Black	•	–	•	–
– Front and rear, body-color	–	•	–	•
DAYTIME RUNNING LAMPS	0	0	0	0
DOORS – Window Group 01 – Includes rear hinged doors with fixed glass and sliding side doors with vented glass (Wagon models only)	•	•	–	–
– Window Group 02 – Includes power second-row windows and rear doors with fixed windows (included with Taxi Cab Package and Popular Equipment Group)	P	P	–	–
– Window Group 03 – Includes side and rear doors with solid panels	–	–	•	•
– Window Group 04 – Includes left and right sliding door panels / rear doors with fixed windows	–	–	0	0
– Window Group 05 – Includes left and right sliding cargo doors with grates and vented glass / rear doors with fixed windows	–	–	0	0
– Window Group 06 – Includes left and right sliding doors with vented side windows / rear doors with fixed windows (requires Cargo Partition Pack – Solid or Cargo Partition Pack – Window)	–	–	0	0
– Window Group 06A – Includes power second-row windows and rear doors with fixed windows (requires Cargo Partition Pack – Window or Cargo Partition Pack – Solid; packaged with Popular Equipment Group)	–	–	–	P

	Wagon	Wagon SLT	Tradesman Cargo Van	Tradesman SLT Cargo Van
EXTERIOR FEATURES (continued)				
DOORS (continued) – Window Group 07 – Includes left sliding cargo door panel / right sliding door with grate and vented window / rear doors with fixed windows	–	–	0	0
– Window Group 08 – Includes left sliding cargo door panel / right sliding cargo door with vented glass / rear doors with fixed windows (requires Cargo Partition Pack – Window or Cargo Partition Pack – Solid)	–	–	0	0
– Window Group 09 – Includes left sliding door panel and right sliding cargo door grates with vented windows / rear door panels	–	–	0	0
– Window Group 10 – Includes left / right sliding cargo doors with grates and vented glass / rear door panels	–	–	0	0
– Rear doors with 180-degree opening	•	•	•	•
FOG LAMPS – Front (requires Lights and Wheels Group)	–	P	–	P
GLASS – Deep-tint	0	•	0	0
RAM GRILLE	•	•	•	•
HEADLAMPS – Halogen	•	•	•	•
MIRRORS – Remote, manual-adjustable	•	–	•	–
– Power-adjustable, folding, heated with body-color caps	–	•	–	•
ROOF RACK – Side Rails (by Mopar®; limited availability)	0	0	0	0
ROOF RACK CROSSBARS (by Mopar; limited availability)	0	0	0	0
CROSSBARS – Three-Bar Utility (not available with Roof Rack Side Rails; by Mopar)	0	0	0	0
SPLASH GUARDS – Vehicle set (by Mopar; limited availability)	0	0	0	0
TIRE SERVICE KIT – Includes puncture sealant and portable air compressor	•	•	•	•
TIRES – 215/55R16XL BSW All-Season	•	•	•	•
WHEELS – 16-inch steel painted Silver with center cap	•	–	•	–
– 16-inch steel painted Black with full-painted Silver wheel covers (included with Taxi Cab Package)	O/P	•	0	•
– 16-inch aluminum (requires Lights and Wheels Group)	–	P	–	P
– Full-size spare tire	0	0	0	0
– Full-size Spare Tire and Inflator Kit	0	0	0	0

• = Standard 0 = Optional P = Part of Package F = Fleet only – = Not available

2020 RAM PROMASTER CITY®
BUYER'S GUIDE

INTERIOR FEATURES

	Wagon	Wagon SLT	Tradesman® Cargo Van	Tradesman SLT Cargo Van
AIR CONDITIONING	•	•	•	•
DOOR LOCKS – Power, speed-sensitive	•	•	•	•
FLOOR MATS – Front and Rear Carpet (by Mopar®; limited availability)	0	0	–	–
– Front and Rear Slush (by Mopar)	0	0	–	–
– Front Carpet (by Mopar; limited availability)	–	–	0	0
– Front Slush (by Mopar; limited availability)	0	0	–	–
LIGHTING – Map / courtesy / cargo lamps	•	•	•	•
CARGO AREA LIGHTING – LED (by Mopar)	–	–	0	0
SEATS – 60/40 Fold-and-Tumble three-person rear bench	•	•	–	–
– Cloth low-back bucket with manual adjuster	•	–	•	–
– Heated front (included with Popular Equipment Group)	–	0/P	–	0/P
– Premium cloth bucket with driver-side manual lumbar and height adjusters	–	•	–	•
– Premium vinyl bucket with driver-side manual lumbar and height adjusters and passenger-side manual lumbar adjuster (included with Taxi Cab Package on Wagon; not available with heated front seats)	0/P	0	0	0
SPEED CONTROL	0	•	0	•
STEERING COLUMN – Tilt / telescoping	•	•	•	•
STEERING WHEEL – Base	•	–	•	–
– Leather-wrapped with audio controls (included with Uconnect® 3 NAV with 5-inch display)	P	•	P	•
WINDOWS – Front, power with one-touch up / down	•	•	•	•
– Second-row power (included with Popular Equipment Group and Taxi Cab Package)	P	P	–	P

UCONNECT MULTIMEDIA

	Wagon	Wagon SLT	Tradesman Cargo Van	Tradesman SLT Cargo Van
UCONNECT 3 WITH 5-INCH DISPLAY – Includes AM / FM and Integrated Voice Command with Bluetooth®	•	•	•	•
UCONNECT 3 NAV WITH 5-INCH DISPLAY AND NAVIGATION – Includes AM / FM / NAV and leather-wrapped steering wheel with audio controls on Tradesman Cargo Van and Wagon models	0	0	0	0
SIRIUSXM® RADIO ¹³ WITH ONE-YEAR TRIAL	0	0	0	0
SPEAKERS – Four	•	•	•	•
– Six (packaged with Popular Equipment Group)	–	P	–	–
RAM TELEMATICS™ – Includes one-year service	0	0	0	0
– Three-year subscription	0	0	0	0
– Five-year subscription	0	0	0	0

SAFETY & SECURITY

	Wagon	Wagon SLT	Tradesman Cargo Van	Tradesman SLT Cargo Van
AIR BAGS ⁸ – Driver and front-passenger	•	•	•	•
– Driver inflatable knee bolster	•	•	•	•
– Supplemental front-seat side	•	•	•	•
– Supplemental side-curtain for 1st and 2nd rows	•	•	–	–
– Supplemental side-curtain for 1st row	–	–	•	•
DOT-CERTIFIED ROADSIDE SAFETY KIT (by Mopar)	0	0	0	0
ELECTRONIC STABILITY CONTROL (ESC) ¹¹ – Includes All-Speed Traction Control, Brake Assist, Brake-Lock Differential, Electronic Roll Mitigation, Hill Start Assist and Trailer Sway Control ¹²	•	•	•	•
PARKSENSE® REAR PARK ASSIST SYSTEM ¹⁰	0	0	0	0
PARKVIEW® REAR BACK-UP CAMERA ⁹	•	•	•	•
REMOTE KEYLESS ENTRY	•	•	•	•
REMOTE START SYSTEM ¹⁹ (by Mopar)	0	0	0	0
TIRE PRESSURE MONITORING (TPM) SYSTEM – Warning lamp	•	•	•	•

• = Standard 0 = Optional P = Part of Package F = Fleet only – = Not available

2020 RAM PROMASTER CITY®
BUYER'S GUIDE

PACKAGES / EQUIPMENT GROUPS

	Wagon	Wagon SLT	Tradesman® Cargo Van	Tradesman SLT Cargo Van
CARGO PARTITION PACKAGE – No window - Includes rear-wall trim	–	–	0	0
– With window - Includes rear-wall trim	–	–	0	0
LIGHTS AND WHEELS GROUP – Includes front fog lamps and 16-inch aluminum wheels	–	0	–	0
POPULAR EQUIPMENT GROUP – Includes heated front seats, Window Group 02 and six speakers (Wagon models); heated front seats and Window Group 06A on Cargo Van	–	0	–	0
REAR WIPER / WASHER / DEFROSTER GROUP – Includes rear window defroster and rear window wiper / washer (included with Taxi Cab Package; requires deep-tint sunscreen glass; not available with Window Group 03 sliding side and rear doors with solid panels)	0/P	0	0	0

PACKAGES / EQUIPMENT GROUPS (continued)

	Wagon	Wagon SLT	Tradesman Cargo Van	Tradesman SLT Cargo Van
RV-READY PREP PACKAGE – Includes upfit interface connector and Class III hitch receiver with four- and seven-pin wiring harness (restrictions apply)	0	0	0	0
TAXI CAB PACKAGE – Includes Rear Wiper / Washer / Defroster Group; premium vinyl bucket seats; upfit interface connector; two additional key fobs; Black, heated, power-adjustable mirrors; Window Group 02 and 16-inch steel wheels painted Black with full-painted Silver wheel covers	F	–	–	–
MOPAR TRAILER TOW GROUP – Includes Class III hitch receiver with four- and seven-pin wiring harness (not available with RV-Ready Prep Package)	0	0	0	0

• = Standard 0 = Optional P = Part of Package F = Fleet only – = Not available



Shown with aftermarket upfit.

EXTERIOR COLORS



Silver Metallic



Quartz Gray Metallic



Blue Night Metallic



Black Metallic



Bright Red



Deep Red Metallic



Bright White

INTERIOR FABRIC COLORS

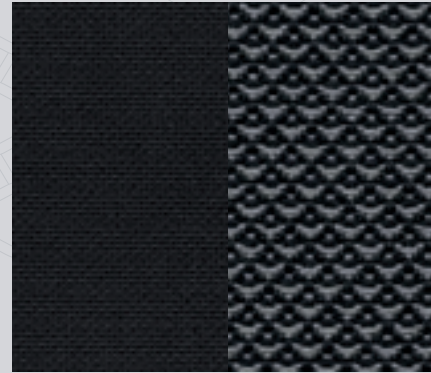

Black Cloth

Standard on Tradesman® Cargo Van/Wagon

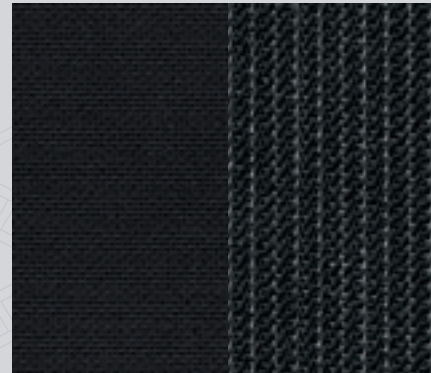

Premium Black Cloth

Standard on SLT Cargo Van/Wagon

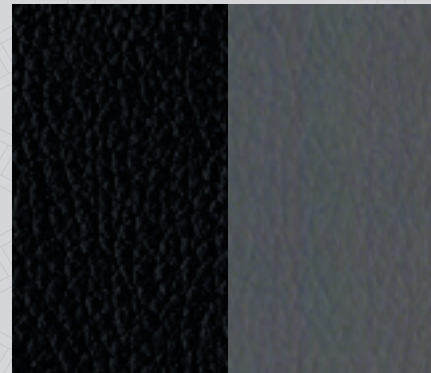

Premium Black Vinyl

(seat surfaces are Diesel Gray Vinyl)

Available on Tradesman and SLT Cargo Van/Wagon
Included with Taxi Cab Package

WHEELS



16-inch Steel Wheel painted
Silver with Center Cap
Standard on Tradesman
Cargo Van/Wagon



16-inch Steel Wheel with
full-painted Silver Wheel Cover
Standard on SLT Cargo Van/Wagon
Available on Tradesman
Cargo Van/Wagon
Included with Taxi Cab Package



16-inch Aluminum Wheel
Available on SLT Cargo Van/Wagon

RAM PROMASTER CITY® WAGON & CARGO VAN – SPECIFICATIONS

2.4L TIGERSHARK® MULTIAIR®2 I-4

HORSEPOWER	BEST-IN-CLASS 178 HP¹ @ 6,400 rpm
TORQUE	BEST-IN-CLASS 174 LB-FT¹ @ 3,800 rpm
CONFIGURATION	In-line four-cylinder
DISPLACEMENT	144 cu in (2,360 cc)
BORE x STROKE	3.46 x 3.82 in (88.0 x 97.0 mm)
BLOCK MATERIAL	Aluminum
CYLINDER HEAD MATERIAL	Aluminum
AIR INDUCTION	Naturally aspirated
VALVE TRAIN	Chain-driven DOHC, 16-valve
FUEL DELIVERY	Sequential, multiport injection
RECOMMENDED FUEL	Unleaded regular (87-octane)
COMPRESSION RATIO	10.0:1
ALTERNATOR	160-amp
OIL CAPACITY	5.5 quarts

THE HEART OF THE EFFICIENCY. Mated to the class-exclusive 9-speed automatic transmission; this proven in-line 4-cylinder powerhouse provides stellar economic figures. Among them: best-in-class horsepower¹; best-in-class torque¹; best-in-class highway driving range with standard motor²⁰; unsurpassed towing capability—up to 2,000 lb¹ on Cargo Van models. Finally, it all runs on pocketbook-friendly 87-octane gasoline, with the confidence that comes from a comprehensive 5-Year/60,000-Mile Powertrain Limited Warranty.⁵ In the final analysis, Ram ProMaster City is a rolling example of low costs of ownership and operation.



PAYLOAD / TOWING	WAGON	WAGON SLT	TRADESMAN® CARGO VAN	TRADESMAN SLT CARGO VAN
GVWR⁶	5,395	5,395	5,395	5,395
GCWR⁶	5,900	5,900	5,900	5,900
CURB WEIGHT	3,671	3,671	3,501	3,501
MAXIMUM PAYLOAD⁷	1,720	1,720	1,890	1,890
MAXIMUM TOWING⁷	1,878	1,878	2,000	2,000

Notes regarding this chart: weights given in lb. Trailer Weight Rating and Tow Vehicle Trailering Weight are calculated as specified in SAE J2807. Driver and passenger weight = 300 lb. Trailer Equipment Weight = 50.7 lb for conventional hitch. Specifications subject to change. See dealer for details.

RAM PROMASTER CITY® WAGON & CARGO VAN – SPECIFICATIONS

DIMENSIONS (in inches unless otherwise noted)

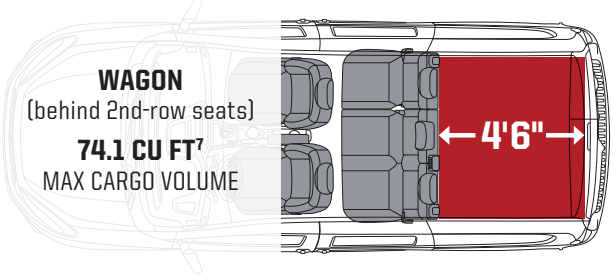
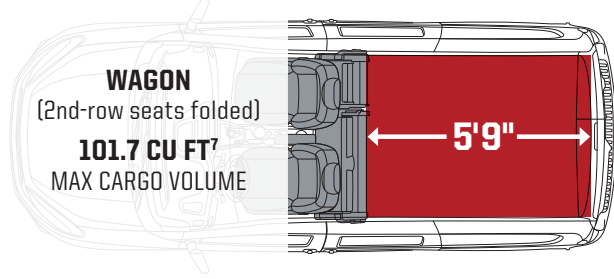
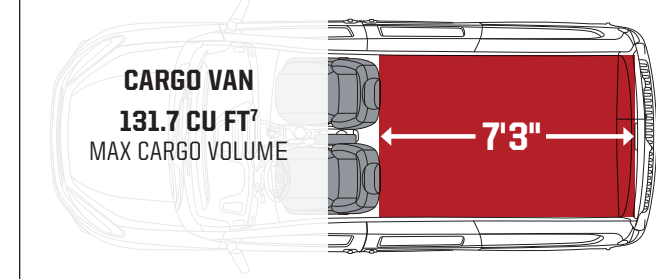
	WAGON	WAGON SLT	TRADESMAN® CARGO VAN	TRADESMAN SLT CARGO VAN
CARGO AREA – HEIGHT	48.7	48.7	51.8	51.8
– LOAD FLOOR LENGTH <small>(behind 2nd-row seats on Wagon / second-row seats folded on Wagon)</small>	54.7 / 69.2	54.7 / 69.2	87.2	87.2
– VOLUME (cu ft) <small>(behind 2nd-row seats on Wagon / second-row seats folded on Wagon)</small>	74.1 / 101.7	74.1 / 101.7	131.7	131.7
 <p>WAGON <small>(behind 2nd-row seats)</small> 74.1 CU FT⁷ MAX CARGO VOLUME</p>	 <p>WAGON <small>(2nd-row seats folded)</small> 101.7 CU FT⁷ MAX CARGO VOLUME</p>	 <p>CARGO VAN 131.7 CU FT⁷ MAX CARGO VOLUME</p>		
DOOR OPENING HEIGHT – REAR CARGO	46.4	46.4	47.4	47.4
– SIDE SLIDING	42.7	42.7	43.6	43.6
DOOR OPENING WIDTH – REAR CARGO	48.6	48.6	48.6	48.6
– SIDE SLIDING	21.2	21.2	25.8	25.8
HEAD ROOM – FIRST-ROW	45.8	45.8	45.8	45.8
– SECOND-ROW	44	44	–	–
HEIGHT – OVERALL	74.2	74.2	74.2	74.2
HIP ROOM – FIRST-ROW	52.8	52.8	52.8	52.8
– SECOND-ROW	59.2	59.2	–	–
LEG ROOM – FIRST-ROW	40.8	40.8	40.8	40.8
– SECOND-ROW	36.8	36.8	–	–
LENGTH – OVERALL BODY	187.1	187.1	187.1	187.1
REAR DOOR LIFT-IN HEIGHT	23.8	23.8	23.3	23.3
SIDE DOOR STEP-IN HEIGHT	19.3	19.3	21.5	21.5
WHEELBASE	122.4	122.4	122.4	122.4
WIDTH – BETWEEN WHEEL WELLS	48.4	48.4	48.4	48.4
– MAXIMUM BETWEEN SIDE PANELS	57.6	57.6	60.4	60.4
– VEHICLE (including mirrors)	84.6	84.6	84.6	84.6



THE DEALER NETWORK FOR YOUR BUSINESS.

Your **BusinessLink** dealer is committed to providing you, the small business owner, with the vehicle support you need for your business, from servicing all makes and models of your existing vehicles to selling you the right vehicles needed to perform the work that you do. Your **BusinessLink** dealer provides priority service because we know downtime is costing you money. Your **BusinessLink** dealer has sales professionals trained to properly “job-rate” the right vehicle for your work application along with providing commercial finance options. New vehicle sales to qualified small business owners also receive a free alternate transportation contract, in the event your vehicle is in for service.

Membership in the **BusinessLink** program is free. Membership helps us to identify you as a small business owner so we can provide you with both the service you deserve and update you with offers that can help reduce the costs of doing business. Ask your **BusinessLink** dealer to register today.

BusinessLink has you covered.

- ▶ Full Range of FCA Commercial Vehicles
- ▶ Free Membership
- ▶ Priority Service
- ▶ Extended Service Hours
- ▶ Dedicated Staff of Commercial Vehicle Experts
- ▶ Free Alternate Transportation
- ▶ Generous Incentives
- ▶ Expertise in Commercial Financing Options
- ▶ 24/7 Towing Service Available

ON THE JOB

INCENTIVES FOR SMALL BUSINESSES.

Running a business presents plenty of challenges. Like cutting costs, not corners. Like saving time and money while avoiding hassles. The **ON THE JOB**²¹ commercial incentive program provides assistance in customizing and servicing your business vehicles.

ON THE JOB²¹ allowances make your business more profitable!

- ▶ **NO-EXTRA-CHARGE** 2-Year Gas/4-Year Diesel Lube-Oil-Filter Allowance
- ▶ **\$300 - \$1,000** Allowance on Select Mopar® Service Contracts
- ▶ **UP TO \$1,000** Commercial Graphics Program Allowances²²
- ▶ **UP TO \$1,000** Commercial Equipment/Upfit Allowances²³

CHRYSLER

C A P I T A L

A commercial line of credit from Chrysler Capital is ideal for qualified business customers looking for a flexible, easy way to manage growing vehicle needs. Chrysler Capital streamlines the process—and with prequalification, you’re ready to buy a vehicle when you need it. Ask your **BusinessLink** dealer for details.

RAM OUTFITTER

BORN UNDER THE RAM LOGO. Ram Outfitter is where you'll find the useful, the cool and the stylish—from clothing and caps to coolers and tools. Make the Ram identity part of your everyday lifestyle. It's all at outfitter.ramtrucks.com



JOIN IN

**RAM
NATION**



Join fellow Ram enthusiasts and tell your story by posting comments, participating in discussions, and sharing your photos and videos. Join our community on Facebook, Twitter, YouTube and Instagram.

Explore Ram Life at ramtrucks.com/ram-life.html

1 Class is Small Commercial Van segment (Class 1). When properly equipped. See dealer for details. 2 Class is Small Commercial Van segment. EPA-estimated 28 hwy mpg, 2.4L automatic 9-speed transmission. Actual mileage may vary. 3 Based on best-in-class cargo capacity, best-in-class payload and best-in-class hwy mpg. Class is Small Commercial Van segment (Class 1). 4 Based on manufacturer testing. Always drive carefully, consistent with conditions. Always wear your seat belt and obey posted speed limits. 5 Visit Mopar.com for complete details and a copy of the Powertrain Limited Warranty. 6 Assumes properly equipped vehicle and 150-lb allowance for driver. Additional options, equipment, passengers and cargo weight must be subtracted. See dealer for details. 7 When properly equipped. See dealer for details. 8 Always sit properly in designated seating positions with seat belts securely fastened at all times. 9 Always check entire surroundings visually before proceeding. 10 Always look before proceeding. An electronic drive aid is not a substitute for conscientious driving. Always be aware of your surroundings. 11 Always drive carefully, consistent with conditions. Always wear your seat belt and obey traffic laws. 12 Always drive carefully, consistent with conditions. 13 SiriusXM Radio, SiriusXM Traffic and SiriusXM Travel Link each require a subscription sold separately, or as a package, by Sirius XM Radio Inc. **If you decide to continue service after your 1-year trial included with the new vehicle purchase, the subscription plan you choose will automatically renew thereafter and you will be charged according to your chosen payment method at then-current rates.** Trial service is not transferable. Fees and taxes apply. Please see the Customer Agreement at www.siriusxm.com for complete terms and how to cancel, which includes calling SiriusXM at 1-866-635-2349. All fees and programming are subject to change. Not all vehicles or devices are capable of receiving all services offered by SiriusXM. Data displays and individual product availability vary by vehicle hardware. Current information and features may not be available in all locations, or on all receivers. Weather Forecast, Current Conditions may not be available in all locations. 14 Visit Mopar.com for complete details and a copy of the Basic Limited Warranty. 15 Never operate the vehicle with the seats reclined to the extent that the seat belts are not secure and flat against your torso. 16 Check Owner's Manual for hitch type, load capacity and heavy-duty equipment required. Do not exceed rated tow capacity of the vehicle as equipped. Trailer may require items not supplied by Mopar. 17 Not available from Mopar; sold separately. 18 Carrier mounts to the Mopar Side Rails with Adjustable Crossbars or Mopar Three-Bar Utility Roof Rack; accessories are sold separately. 19 Check state and local laws regarding the use of remote start systems. 20 Class is Small Commercial Van segment (Class 1). EPA-estimated 28 hwy and 16-gallon fuel tank, 2.4L automatic 9-speed transmission. Actual mileage may vary. 21 ON THE JOB is a retail incentive program; see your dealer for official rules. Inquire about eligibility by calling 877-ONTHEJOB or by logging on to www.fcausfleet.com. The purchaser or lessee must be a qualified commercial customer for more than 30 days prior to the date of the vehicle purchase. An official ON THE JOB Customer Acknowledgment Form must be signed by the customer (provided by the dealer). 22 Allowance varies by graphic program. See dealer for details. Take retail delivery by 12/01/2020. 23 Allowance varies by upfit and model. See dealer for details. Take retail delivery by 12/01/2020.

©2019 FCA US LLC. All Rights Reserved. Ram, Mopar, the BusinessLink design, ParkSense, ParkView, the Ram's Head logo, Ram ProMaster City, Tigershark, Tradesman and Uconnect are registered trademarks, and DriveAbility & design, On The Job & design and Ram Telematics are trademarks of FCA US LLC. Chrysler Capital is a registered trademark of FCA US LLC and licensed to Santander Consumer USA Inc. MultiAir is a registered trademark of C.R.F. Società Consortile per Azioni, used under license by FCA US LLC.

Bluetooth is a registered trademark of Bluetooth SIG, Inc. Sirius XM Connected Vehicles Services Inc. Sirius, XM and SiriusXM and all related marks and logos are trademarks of Sirius XM Radio Inc. Facebook and logo are registered trademarks of Facebook, Inc. The Twitter logo is a service mark of Twitter, Inc. YouTube and other marks are registered trademarks of Google LLC. Instagram and logo are registered trademarks of Instagram, Inc. Katerack is a registered trademark of Dejana Truck & Utility Equipment Co. All rights reserved.

About this catalog: since the time of publication, some of the information you'll find in this catalog may have been updated. Ask your dealer for details. Some of the equipment shown or described throughout this catalog may be available at extra cost. Specifications, descriptions, illustrative materials and all competitive comparisons contained herein are as accurate as known at the time this publication was approved for printing. FCA US LLC reserves the right to discontinue models at any time or change specifications without notice or without incurring obligation. Options may be required in combination with other options. For the price of the model with the equipment you desire, or verification of specifications contained here, see your Ram dealer.



For more information, visit ramtrucks.com/promastercity

Ram is a registered trademark of FCA US LLC.

74-383-2026_1/20