



2021 RAM COMMERCIAL



THE RAM COMMERCIAL FAMILY: GETTING THE JOB DONE RIGHT

Ram Chassis Cab shown with aftermarket upfit.

RAM CHASSIS CAB

3500/4500/5500

BEST-IN-CLASS: AVAILABLE MAX DIESEL TRAILERING:
29,770 LB (4500)^{1*}
35,220 LB (5500)²

BEST-IN-CLASS: AVAILABLE MAX DIESEL GCWR:
37,500 LB (4500)^{1,3}
43,000 LB (5500)^{2,3}

AVAILABLE MAX DIESEL TORQUE: 800 LB-FT

RAM PROMASTER®

CARGO VAN/CHASSIS CAB/CUTAWAY

CLASS-EXCLUSIVE: FRONT-WHEEL DRIVE⁹

BEST-IN-CLASS: STANDARD CARGO HEIGHT: 66.3 IN⁹

BEST-IN-CLASS: WIDTH BETWEEN WHEEL WELLS: 56 IN⁹

BEST-IN-CLASS: MAX CARGO WIDTH: 75.6 IN⁹

BEST-IN-CLASS: LOWEST LOAD FLOOR HEIGHT⁹

BEST-IN-CLASS: MAX PAYLOAD: 4,680 LB (CARGO VAN)¹⁰

BEST-IN-CLASS: TURNING DIAMETER: 36.3 FT
(118-IN WHEELBASE)⁹

AVAILABLE MAX TOWING: 6,910 LB (CARGO VAN)⁹

RAM HEAVY DUTY PICKUP

2500/3500

AMERICA'S LONGEST LASTING HEAVY-DUTY PICKUPS⁴

BEST-IN-CLASS: STANDARD GAS HORSEPOWER: 410 HP⁵

BEST-IN-CLASS: AVAILABLE MAX DIESEL TORQUE:
1,075 LB-FT (3500)⁵

BEST-IN-CLASS: AVAILABLE MAX DIESEL TOWING:
37,100 LB (3500)⁵

RAM PROMASTER CITY®

CARGO VAN/PASSENGER WAGON

BEST-IN-CLASS: CARGO CAPACITY: 131.7 CU FT
(CARGO VAN; BEHIND FIRST ROW)¹¹

BEST-IN-CLASS: PAYLOAD: 1,890 LB
(CARGO VAN)¹¹

BEST-IN-CLASS: HORSEPOWER: 178 HP¹¹

BEST-IN-CLASS: TORQUE: 174 LB-FT¹¹

BEST-IN-CLASS: MAX GVWR: 5,395 LB^{9,11}

RAM LIGHT DUTY PICKUPS

1500

MOST AWARDED LIGHT-DUTY TRUCK IN AMERICA⁶

LARGEST BRAKES IN ITS CLASS⁷

BEST-IN-CLASS: AVAILABLE DIESEL TOWING: 12,560 LB⁷

BEST-IN-CLASS: AVAILABLE DIESEL TORQUE: 480 LB-FT⁷

AVAILABLE MAX V8 TOWING: 12,750 LB⁹

MAX PAYLOAD: 2,300 LB⁹

1500 CLASSIC

CLASS-EXCLUSIVE:

STANDARD LINK COIL REAR SUSPENSION¹²

CLASS-EXCLUSIVE:

AVAILABLE RAMBOX® CARGO MANAGEMENT SYSTEM¹²

MAX TOWING: 10,610 LB⁹

MAX PAYLOAD: 1,930 LB⁹

*All disclosures can be found on the last page.

SUPPORTING YOU AND YOUR BUSINESS



Some demand capability, reliability and toughness. Others won't settle for less than complete comfort and luxury. Of course, for others, technology is nonnegotiable. But for those that want it all, there is the Ram Brand. Regardless of which Ram vehicle you choose, you can be sure it was engineered to deliver. The Ram Commercial lineup brings incredible performance and available state-of-the-art Ram Telematics™. Ram 1500 boasts impressive frame strength and robust towing. Work-ready capability and a smooth-shifting 8-speed transmission are at the heart of the 2500/3500 pickups. There's exceptional towing, payload, GCWR and GVWR for Chassis Cab. Ram ProMaster® and Ram ProMaster City® models showcase versatility and a wealth of commercial-grade assets. Get more at ram.com/commercial



- 4500/5500 CHASSIS CAB.4
- 3500 CHASSIS CAB.7
- 2500/3500 PICKUP9
- RAMBOX® & BED FEATURES.14
- 1500 PICKUP15
- TRUCK INTERIORS18
- UCONNECT®20
- TRUCK CAMERA COVERAGE26
- TRUCK SAFETY AND SECURITY28
- RAM TELEMATICS31
- 1500 CLASSIC PICKUP.33
- PROMASTER35
- PROMASTER CITY40
- POWERTRAINS
 - 3500/4500/5500 CC.44
 - 2500/3500 PICKUP.45
 - 1500 PICKUP46
 - 1500 CLASSIC PICKUP47
 - PROMASTER48
 - PROMASTER CITY.48
- CONFIGURATIONS
 - PICKUP.49
 - CHASSIS CAB49
 - PROMASTER50
 - PROMASTER CITY.50
- BUSINESS SUPPORT51
- RAM NETWORK.52

RAM 4500/5500 CHASSIS CAB



Shown with aftermarket upfit.



360 HORSEPOWER
800 LB-FT OF TORQUE

READY FOR THE TOUGHEST JOBS. Ram 4500/5500 Chassis Cab comes to work with exceptional capability, outstanding towing and hauling, and impressive versatility for available Power Take-Off (PTO). Ram Chassis Cab highlights include work-ready GCWR and max trailering numbers, huge available torque from the available Cummins® Turbo Diesel, along with best-in-class oil change intervals¹³ across the board.

RAM 4500 CHASSIS CAB

BEST-IN-CLASS
AVAILABLE MAX DIESEL GCWR:
37,500 LB^{1,3}

BEST-IN-CLASS
MAX GAS GCWR:
28,500 LB^{1,3}

UNSURPASSED-IN-CLASS-4 Max GVWR: **16,500 LB^{1,3}**

BEST-IN-CLASS Available Max Diesel Trailering: **29,770 LB¹**

BEST-IN-CLASS Max Gas Trailering: **21,540 LB¹**

RAM 5500 CHASSIS CAB

BEST-IN-CLASS
AVAILABLE MAX DIESEL GCWR:
43,000 LB^{2,3}

BEST-IN-CLASS
MAX GAS GCWR:
28,500 LB^{2,3}

UNSURPASSED-IN-CLASS-5 Max GVWR: **19,500 LB^{2,3}**

BEST-IN-CLASS Available Max Diesel Trailering: **35,220 LB²**

Max Gas Trailering: **21,490 LB²**

STRENGTH AND CAPABILITY

A SOLID FOUNDATION YOU CAN BUILD ON

- ▶ Unsurpassed 50,000-psi rear-frame steel strength¹³
- ▶ 63,000-psi steel front engine crossmember
- ▶ Cast iron front track bar bracket
- ▶ Hydroformed front rail sections
- ▶ 50,000-psi rear C-Channel frame rails with eight separate crossmembers

FRONT SUSPENSION STRENGTH

- ▶ Robust five-link coil spring front suspension and beam axle
- ▶ Shock absorbers uniquely tuned to each wheelbase and engine combination
- ▶ Heavy-Duty Front Suspension Package (optional) with taller springs, higher spring rates and a strengthened engine crossmember. Recommended for any vehicle with a forward-biased weight upfit (like an aerial boom or our Snow Plow Package)

REAR SUSPENSION TECHNOLOGY

- ▶ Long-proven two-stage longitudinal leaf springs, tuned to maintain impressive payload and towing capabilities. Retains vehicle attitude at load and overall vehicle dynamics

MAXIMUM TRAILERING

Ram 4500 Chassis Cab

- ▶ Up to 21,540-lb towing⁹ (with the 6.4L HEMI[®] V8)
- ▶ Up to 29,770-lb towing⁹ (with the available 6.7L Cummins[®] Turbo Diesel)

Ram 5500 Chassis Cab

- ▶ Up to 21,490-lb towing⁹ (with the 6.4L HEMI V8)
- ▶ Up to 35,220-lb towing⁹ (with the available 6.7L Cummins Turbo Diesel)

OUTSTANDING CAPABILITY

- ▶ Unsurpassed-in-Class-4 max GVWR of 16,500 lb^{1,3} (with gas or diesel)
- ▶ Unsurpassed-in-Class-5 max GVWR of 19,500 lb^{2,3}

BEST-IN-CLASS GCWR^{1,2}

- ▶ Up to 28,500-lb GCWR³ (4500/5500 with the 6.4L HEMI V8)
- ▶ Up to 37,500-lb GCWR³ (4500 with the available 6.7L Cummins Turbo Diesel)
- ▶ Up to 43,000-lb GCWR³ (5500 with the available 6.7L Cummins Turbo Diesel)

CONVENIENCE AND PEACE OF MIND

- ▶ **BEST-IN-CLASS** up to 12,500-mile diesel oil change intervals¹³ (with available Cummins)
- ▶ **BEST-IN-CLASS** up to 8,000-mile gas oil change intervals¹³ (with standard 6.4L HEMI V8)
- ▶ **CLASS-EXCLUSIVE** available Active Grille Shutters¹⁴
- ▶ **CLASS-EXCLUSIVE** available Adaptive Cruise Control with Stop¹⁵
- ▶ **CLASS-EXCLUSIVE** available Trailer Reverse Guidance¹⁶
- ▶ **CLASS-EXCLUSIVE** available 270° Surround-View Camera System¹⁶

Spec it all out at ram.com/commercial



Shown with aftermarket upfits.

POWER THAT DELIVERS



Shown with aftermarket upfit.



- ▶ **Vehicle System Interface Module (VSIM)**
Helpful inputs and outputs with access to more than 70 distinctive upfitter features including:
 - Lighting outputs
 - PTO controls
 - Six programmable in-cabin auxiliary switches with combined 135-amp output
- ▶ **Seven Trailer-tow Circuits**



- ▶ **Left- or Right-side PTO-mounting Capability**

- ▶ **BEST-IN-CLASS Standard Gas Horsepower¹³: 370 hp** backed by 429 lb-ft of torque from the standard 6.4L HEMI® V8
- ▶ **BEST-IN-CLASS Gas Engine Oil Change Intervals¹³:** Up to 8,000 miles for the standard 6.4L HEMI V8

- ▶ **BEST-IN-CLASS Available Diesel Horsepower¹³: 360 hp** and a no-nonsense 800 lb-ft of torque from the 6.7L Cummins® Turbo Diesel mated with the **CLASS-EXCLUSIVE AISIN®** heavy-duty automatic transmission¹³

- ▶ **BEST-IN-CLASS Available Diesel Engine Oil Change Intervals¹³:** Up to 12,500 miles for the 6.7L Cummins Turbo Diesel
- ▶ **LARGEST-IN-CLASS 52-gallon Single Rear-mounted Fuel Tank¹³:** Standard fuel tank on 4500/5500 Chassis Cab

RAM 3500 CHASSIS CAB

START STRONG. This Ram Truck—with its mighty exterior and refined interior—boasts unsurpassed-in-class max GVWR for gas and available diesel engines,¹⁷ best-in-class standard gas horsepower with the 6.4L HEMI® V8¹⁷ and best-in-class oil change intervals on gas and available diesel engines.¹⁴ Invaluable tech features include available class-exclusive 270° Surround-View Camera System, CHMSL camera and Trailer Reverse Guidance.¹⁶

RAM 3500 CHASSIS CAB

AVAILABLE
MAX DIESEL GCWR:
33,000 LB⁸

MAX GAS GCWR:
25,000 LB⁸

UNSURPASSED-IN-CLASS Max GVWR: **14,000 LB^{8,17}**

BEST-IN-CLASS Standard Max Gas Horsepower: **410 HP¹⁷**
and 429 lb-ft of torque with the 6.4L HEMI V8

Available Max Diesel Towing: **25,890 LB⁸**

Max Gas Towing: **18,950 LB⁸**



Shown with aftermarket upfit.



Shown with aftermarket upfit.

CAPABLE AND FLEXIBLE

THIS FRAME IS READY FOR YOUR UPFIT

- ▶ Unsurpassed 50,000-psi rear-frame steel strength¹⁴
- ▶ Cast aluminum front track bar bracket
- ▶ 63,000-psi and 50,000-psi steel spring tower reinforcements
- ▶ Hydroformed front rail sections
- ▶ 50,000-psi rear C-Channel frame rails with eight separate crossmembers
- ▶ Two-piece front suspension crossmember structure for longer welded interface and greater frame strength

UPFIT-FRIENDLY

- ▶ Industry-standard 34-inch frame rail spacing
- ▶ Pre-drilled frame-mounting holes
- ▶ Fuel-fill hose through the frame
- ▶ Under-the-cab DEF tank positioned away from upfit zone
- ▶ Left- or right-side PTO-mounting capability

RAM ELECTRICAL SYSTEMS

- ▶ Convenient inputs and outputs with access to more than 70 distinctive upfitter features including:
 - Lighting outputs
 - PTO controls
 - Six programmable in-cabin auxiliary switches with combined 135-amp output (all of which are addressable through the SAE J1939-compliant CAN-bus Vehicle System Interface Module)
- ▶ Seven trailer-tow circuits
- ▶ Available max dual alternator with 380-amp output on HEMI® V8 and 440-amp output on Cummins®

STELLAR PTO CAPABILITY

- ▶ Mobile Mode RPM-Up allows higher RPM (in stationary mode) via steering wheel controls, eliminating “feathering” the accelerator
- ▶ Two speeds in split-shaft mode with the available Cummins
- ▶ PTO ramp rate is adjustable via the instrument cluster
- ▶ Hard-Wire Remote Start/Stop and PTO alarm
- ▶ “Memory” feature for its last known state

Spec it all out at ram.com/commercial



Shown with aftermarket upfits.

RAM 2500/3500 PICKUP



UP TO

420 HORSEPOWER
1,075 LB-FT OF TORQUE
37,100-LB TOWING^B

GET THE COMMERCIAL-GRADE ADVANTAGE. With durability and quality engineering built into every Ram Heavy Duty pickup, it's not surprising that Ram 2500/3500 rank as America's Longest Lasting Heavy-Duty Pickups.⁴ The lineup also boasts class-exclusive available features: Auto-Level Rear Air Suspension and the RamBox[®] Cargo Management System.⁵

RAM 2500 PICKUP

AVAILABLE
MAX DIESEL GCWR:
27,980 LB³

MAX GVWR:
10,000 LB³

BEST-IN-CLASS Standard Gas Horsepower: **410 HP⁵**
CLASS-EXCLUSIVE Link Coil Rear Suspension⁵
LARGEST-IN-CLASS Available Fuel Tank: **50 GAL** (Crew Cab only)⁵
LARGEST-IN-CLASS Available Radio Touchscreen: **12 IN⁵**
Available Max Diesel Towing: **20,000 LB³**

RAM 3500 PICKUP

AVAILABLE
MAX DIESEL GCWR:
45,000 LB³

MAX GVWR:
14,000 LB³

BEST-IN-CLASS Standard Gas Horsepower: **410 HP⁵**
BEST-IN-CLASS Available Max Diesel Towing: **37,100 LB⁵**
BEST-IN-CLASS Available Max Diesel Torque: **1,075 LB-FT⁵**
CLASS-EXCLUSIVE Dual-Rear-Wheel Back-Up Sensors⁵
CLASS-EXCLUSIVE Available Power Convex Trailer-Tow Mirrors⁵

MUSCLE THAT PERFORMS

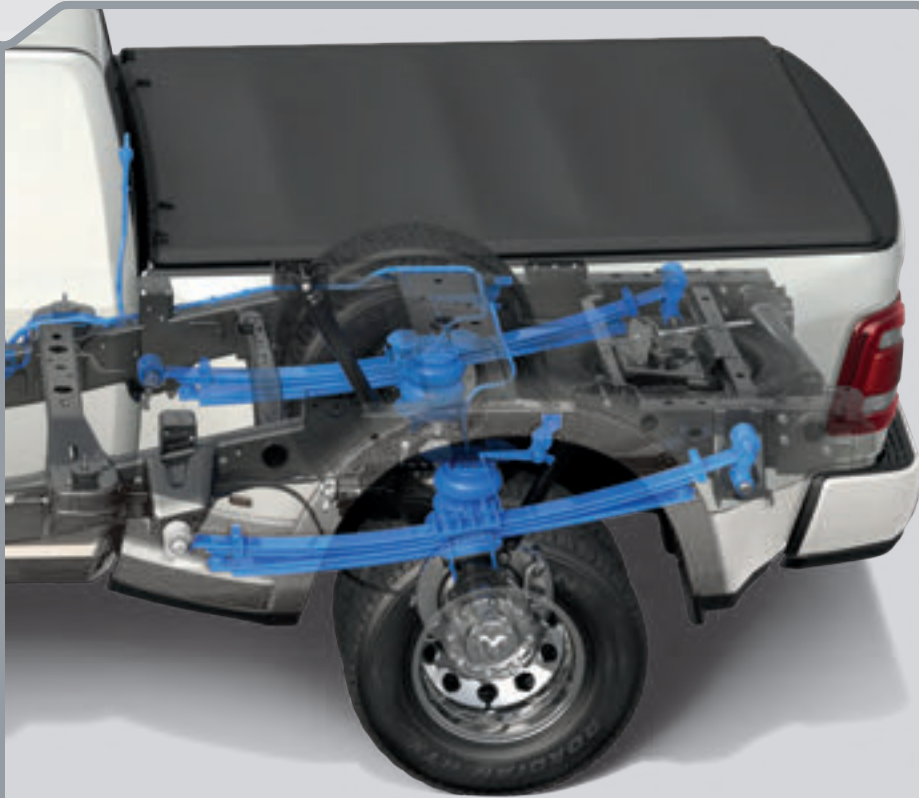

The Ram 3500 available DRW Rear Air Suspension here shows how the leaf springs are augmented with the axle-mounted air springs.

AVAILABLE CLASS-EXCLUSIVE AUTO-LEVEL REAR AIR SUSPENSION⁵ Available only for Ram 2500/3500 Heavy Duty models, this system provides a comfortable ride while increasing control when hauling or towing through a selection of multiple modes.

- ▶ **Payload Mode** With this default mode, load-leveling is improved, so you're assured of a constant and level performance—especially while undertaking serious payload. The system constantly monitors heights on both sides of the vehicle, making critical adjustments in the cases of load shift or changes in road camber
- ▶ **Trailer Mode** The system maintains an even vehicle/trailer rake by raising or lowering the rear suspension, thus ensuring a parallel relationship between vehicle and trailer
- ▶ **Trailer Hookup Mode** which brings the rear suspension to its lowest setting for easier trailer hookup



GOOSENECK/FIFTH-WHEEL varieties of towing rely on pure capability—starting with a strong rear structural crossmember. Note: along with the standard 4-7-pin connector, the factory-installed Fifth-Wheel/Gooseneck Prep Group option includes an additional 7-pin connector integrated into the rear of the bed for easier access. When the Trailer Camera Prep Group is added, the 7-pin connector is upgraded to a 7-12-pin connector.

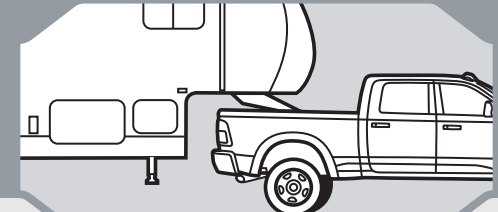
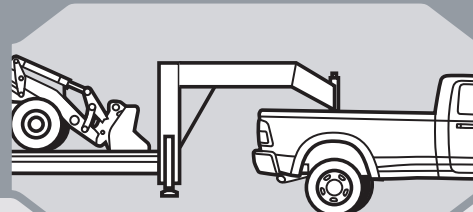

CONFIDENT HEAVY-DUTY CAPACITY. The frames for all models in both weight classes benefit from the use of advanced high-strength steel and tough crossmembers, along with the use of aluminum in strategic areas.

THE FINE-TUNED RAM 2500. The chassis has a finely tuned suspension.

- ▶ Shock absorbers and progressive-rate springs configured to help provide a quality ride, regardless of the load.
- ▶ Bushings engineered for durability and comfort.
- ▶ Smartly designed engine mounts help mitigate Noise, Vibration and Harshness (NVH).

RAM HEAVY DUTY: LONG-LASTING BY DESIGN

Working with the frame and the suspension tuning for Ram 2500 is the TorqueFlite® (8HP75) 8-speed automatic, paired to the 6.4L HEMI® V8. To handle the anticipated towing and payload capacities, the 8HP75 features torque-converter brazing, two gearsets with pinion gears and a heavy-duty park system. Offering a level of shift

refinement not usually seen in heavy-duty trucks, it also features fully electronic operation, an innovative and convenient rotary shifter, and on-the-fly shift mapping, with more than 40 individual maps to optimize shift quality/points—regardless of load or conditions.

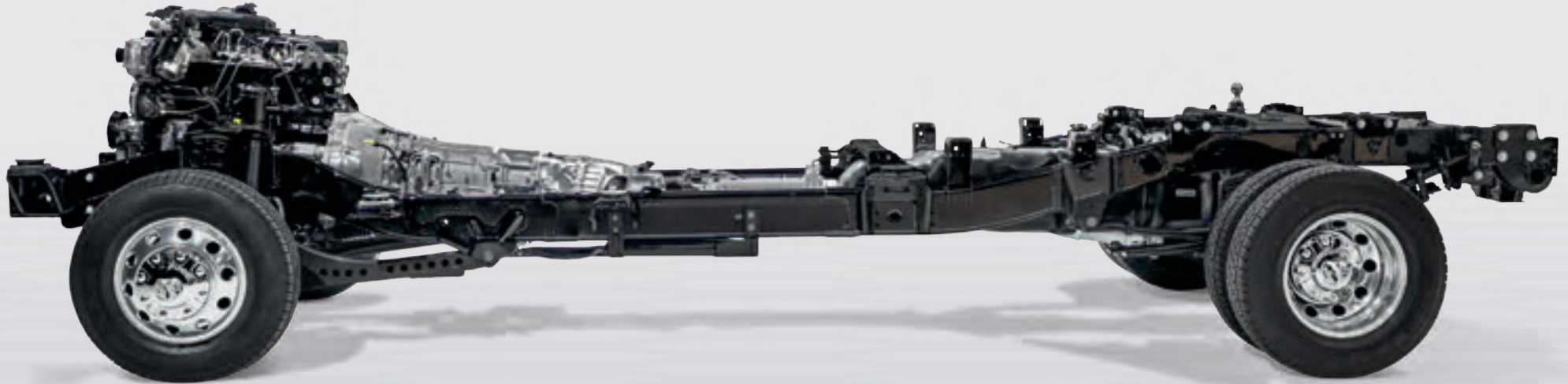

FRAME STRENGTH

Toughness is part of the engineering. Count on robust 63,000-psi steel for the engine crossmember.

RELIABLE 4x4 CAPABILITY

On 4x4 pickup models, a 9.25-inch front axle features sturdy pinion seals; a refined axle housing minimizes Noise, Vibration and Harshness (NVH).

TOUGH AS STEEL

Durability is built into every Ram pickup. 98.5% of the steel used in the Heavy Duty frame is comprised of resilient high-strength steel.

HOOKUP WITH CONFIDENCE

With a standard Class V hitch receiver, conventional hitch capability for a Ram 3500 pickup is a jaw-dropping 23,000 lb.⁹ For 2500, capability is rated at 20,000 lb.⁹

TUNED IN FOR YOUR NEEDS

Suspension tuning on Ram 2500 includes Frequency Response Damping (FRD) shocks and tough, progressive-rate coil springs.

CAPABLE AND COMFORTABLE

Ram 3500 rear two-stage longitudinal leaf-spring suspension supports high payload and towing capacities while providing a comfortable ride, even under heavy loads.

THE POWER YOU WANT



420HP
BEST-IN-CLASS
1,075LB-FT OF TORQUE⁵



CUMMINS® HIGH OUTPUT TURBO DIESEL with the AISIN® 6-SPEED AUTOMATIC TRANS (3500)

The available Cummins diesel—with available torque reaching a stunning best-in-class 1,075 lb-ft⁵—delivers immense capability. Improvements for 2021 include higher limits for boost from a Variable Geometry Turbocharger and flow rate increases in the fuel delivery system. This enables the 6.7L I-6 to produce an additional 75 lb-ft of torque over the previous version.



410HP
429LB-FT OF TORQUE



6.4L HEMI® V8 with VVT and MDS with the 8HP75 8-SPEED AUTOMATIC TRANS

Delivering best-in-class standard gas horsepower⁵, the 6.4L HEMI V8 employs a number of engineering advantages, starting with Variable Valve Timing (VVT), which helps ensure phenomenal towing and payload capability with consistent power across a wide torque band. Efficient by design, the HEMI V8 employs Multi-Displacement System (MDS)/Fuel Saver Technology (transforming the tough V8 into an efficient 4-cylinder) and interactive Deceleration Fuel Shut-Off.



TOW WITH CONFIDENCE



AVAILABLE FEATURES INCLUDE:



ACTIVE FORWARD LIGHTING SYSTEM



TRAILER CAMERA WITH DISPLAY¹⁹



SELF-LEVELING AIR SUSPENSION

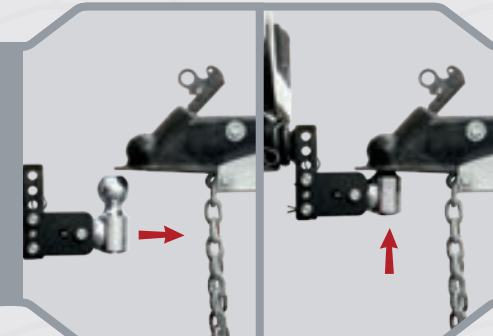

BED-LOWERING MODE WITH AIR SUSPENSION

NEXT-LEVEL STORAGE SOLUTIONS



RAMBOX® CARGO MANAGEMENT SYSTEM

Along with scores of in-cab storage compartments on Ram pickups, the available RamBox Cargo Management System provides ample helpful features, including:

- ▶ **Two Side Storage Bins** which are lockable and drainable
- ▶ **Key Fob Accessibility**
- ▶ **400-watt, 115-volt Power Outlet**, built in for your convenience (not available on 1500 Classic)
- ▶ **RamBox LED Lighting**
- ▶ **Bed Divider** (available)
- ▶ **Cargo Rail System** with four adjustable tie-down cleats (available)
- ▶ **Standard 4x8 Sheet Capacity**



400-WATT, 115-VOLT POWER OUTLET



BED DIVIDER and ADJUSTABLE TIE-DOWN CLEATS (available)

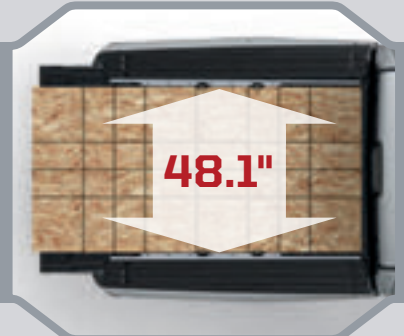

STANDARD 4x8 SHEETS FIT



RETRACTABLE BED STEP. The available Mopar® Bed Step makes getting in and out of your cargo bed easier than ever. A simple foot motion pops it down. Made of tough steel, it's easily installed and is covered with a slip-resistant rubber coating. Available as a factory-installed option or stand-alone Mopar Accessory.

SMART TAILGATE TECHNOLOGY. An available damped tailgate lets you open it more slowly and close it with less force. The tailgate also features an available power-release function: open it with the key fob button or via in-cabin control on the overhead console. (Not available on 1500 Classic.)

IN-BED LED LIGHTING. Controlled by a switch or activated with the unlock button on the key fob, these available side cargo-bed lights help you load anytime and are especially useful if your bed is protected with an available tonneau cover.

RAM 1500 PICKUP



RAM 1500 PICKUP

AVAILABLE
MAX GAS GCWR:
18,350 LB⁹

AVAILABLE
MAX GAS GVWR:
7,100 LB⁹

CLASS-EXCLUSIVE

Available Active-Level™ Four-Corner Air Suspension⁷

CLASS-EXCLUSIVE

Available RamBox® Cargo Management System⁷

CLASS-EXCLUSIVE Standard Link Coil Rear Suspension⁷

BEST-IN-CLASS Available Max Diesel Towing: **12,560 LB⁷**

Available Max V8 Towing: **12,750 LB⁹**

Available 12-inch Touchscreen Media Center

THE LIGHT-DUTY WORKHORSE. Ram 1500 is all about capability, comfort and technology. Among its capability advantages: best-in-class standard V6 horsepower.⁷ No-nonsense available V8 towing. The available 3.0L EcoDiesel V6 with best-in-class 480 lb-ft of diesel torque.⁷ The largest brakes in its class⁷—14.9-inch rotors in front, 14.8-inch rotors in the rear. Ample bed volume with spacious available interior storage. For comfort and technology, count on best-in-class rear leg room,⁷ an available large 12-inch touchscreen media center, the highest number of available speakers in its class⁷ and the powerful audio from the available Harman Kardon® Surround Sound system.

FLEXIBLE AND SUPPORTIVE



AVAILABLE MULTIFUNCTION TAILGATE. This is cargo management made easy. Conventional tailgate operation joins 60/40-split swing-away doors with a 2,000-lb load rating. It's better in every way: closer access to the bed from the bumper, simpler step-up, more convenient loading/unloading (even with a forklift), faster washing out of the bed—and with no need to remove a trailer and/or hitch to open it. (Requires spray-in bedliner.)

eTORQUE TECHNOLOGY AT A GLANCE. Standard on the Pentastar® V6 and available for the HEMI® V8 on Ram 1500, eTorque is a mild-hybrid system which eliminates the alternator and combines a motor generator with a 48-volt battery. Main technological features include:

- ▶ **Electric Power Boost**, which provides optimized efficiency and greater supplemental torque during acceleration and enables the HEMI V8 Multi-Displacement System to operate longer while in 4-cylinder mode.
- ▶ **Stop/Start Technology** helps to improve efficiency by seamlessly turning off the engine at idle stops and restarting operation at acceleration. With eTorque, the engine restart takes only half the time compared to normal Stop/Start.
- ▶ **Regenerative Braking** recovers braking energy and converts it into electricity—which helps recharge the onboard battery system.



THE AVAILABLE CLASS-EXCLUSIVE ACTIVE-LEVEL™ FOUR-CORNER AIR SUSPENSION?

Pioneered by Ram 1500, it remains unique to the Light-Duty Truck segment. Either automatic or driver-operated, the system is available on select trim levels, with five modes that address a wide variety of needs, including off-road ride height, aerodynamic efficiency, ease of cargo access and occupant convenience.

The available Active-Level Four-Corner Air Suspension System uses an air supply component in a single unit to reduce weight and increase capacity.

The five operational modes are engineered to deliver outstanding performance from your Ram 1500. They include two Off-Road Heights, the Aero Mode, Normal Ride Height and the chassis-lowering Entry/Exit Mode.

TAKE IT ON WITH CONFIDENCE

This frame is comprised of high-strength steel, advanced high-strength steel and, in select areas, aluminum. A long list of Ram 1500 advantages takes your towing to commercial-grade levels. Among them:

- ▶ **CLASS-EXCLUSIVE** available Active-Level™ Four-Corner Air Suspension⁷ and the standard Tow/Haul Mode. Both controlled with fingertip ease from the switch bank
- ▶ Standard ParkView® Rear Back-Up Camera¹⁹
- ▶ Available 7x11-inch Trailer-Tow Mirrors
- ▶ Largest Brakes in its Class⁷
- ▶ **Best-in-Class Standard V6 Horsepower⁷** (Pentastar® V6 with eTorque)
- ▶ Up to **12,750-lb Trailering⁹** (available HEMI® V8 eTorque with Max Tow Package)
- ▶ Up to **Best-in-Class Diesel 12,560-lb Trailering⁷** (available EcoDiesel V6 with Max Tow Package)

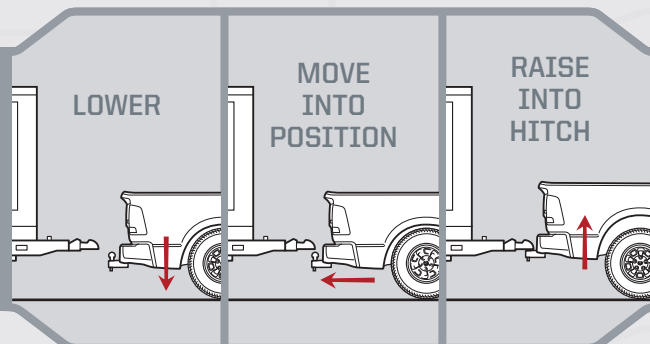

CLASS-EXCLUSIVE ACTIVE-LEVEL FOUR-CORNER AIR SUSPENSION⁷ (available)



FINGERTIP SUSPENSION AND BRAKE CONTROL (available)



PARKVIEW REAR BACK-UP CAMERA¹⁹



RAM 1500: LARGEST STANDARD BRAKES IN ITS CLASS⁷

REFINED AND VERSATILE INTERIORS



UNEXPECTED SOPHISTICATION IN A CAPABLE WORKHORSE

You've made it in business—and Ram Trucks make the drive a pleasure. With true-fidelity audio. Media Hubs with USB ports. Eye-pleasing instrumentation. Whether it's a pickup or a Chassis Cab, from the rugged Tradesman® to the leather-trimmed/real-wood interior of Limited (shown above) to a 2500/3500 Mega Cab®—think intelligent interior storage and the exceptional comfort of an available and class-exclusive reclining rear seat⁵—Ram Trucks put versatility and technology to work for you.

CONVENIENT FOLD-FLAT LOAD FLOORS

For valuable cargo best left inside, utilize the rear area that converts to a genuinely flat floor in moments. (Available on Ram 1500 Classic Quad Cab® and Crew Cab, on 2500/3500 Crew Cab, and on 3500/4500/5500 Chassis Cab Crew Cab models.)

THE REAR IN-FLOOR STORAGE

Ram Crew Cab models take storage one step further with another invaluable advantage: two available removable, drainable and practical in-floor bins.



FOLD-FLAT FLOOR



REAR IN-FLOOR STORAGE

STRENGTH AND INTERIOR COMFORT



CHASSIS CAB CAPABILITIES WITH COMFORT TO MATCH

We think that accomplishing extreme jobs deserves premium amenities. This SLT interior has it all: electronics, convenience, spaciousness and unexpected comfort.



IN TOUCH WHEREVER YOU GO

The Uconnect® system is your customizable, connected vehicle platform dedicated to safe and seamless communication, navigation and entertainment—all from one easy-to-use touchscreen. Smartwatch integration can put the Uconnect App²⁰ right on your Apple Watch.

Uconnect®

DRIVEUCONNECT.COM



8.4-INCH UCONNECT® TOUCHSCREEN DISPLAY



4G WIFI HOTSPOT²³

COMPATIBILITY YOUR WAY

Uconnect brings a wide range of interactive features to your vehicle and beyond through a highly intuitive communication experience.

UCONNECT PHONE²¹

Stay connected safely. Pairs a Bluetooth® phone to send and receive hands-free calls.²¹ Includes:

- **DO NOT DISTURB** to route incoming calls to voice mail and suppress text messages.
- **VOICE RECOGNITION** to make hands-free calls,²¹ listen and respond to text messages,²² record voice memos, and select media stations and navigation destinations.

DRAG-AND-DROP MENU BAR

We've made it easy to customize your Uconnect dashboard with your favorite features and services. Simply press the Uconnect icon on the main menu bar to view all of the available apps. Tap and hold any one of the icons to drag and drop into a personalized menu bar.

SIRI® EYES FREE²⁴

Just say it. Use voice commands with Siri Eyes Free²⁴ and your connected iPhone® to create and send texts, make and receive calls, access directions, and play music. Available.

ONE-STEP NAVIGATION

Take the best route right now. Uconnect employs GPS Navigation for audible turn-by-turn directions, and detailed 3D maps help to ensure you arrive on time. Use Voice Command and say the complete address to get directions quickly. Available.

4G WiFi HOTSPOT²³

Along the way, you can upload, download, post and search. Connects to your personal WiFi²³ device for fast, reliable Internet for up to eight devices within 50 feet of your vehicle. Available.

DRIVEUCONNECT.COM

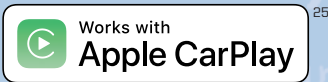

Display some of your favorite iPhone® apps right on your Uconnect® touchscreen. Access your iTunes® library, call anyone in your contacts list or just ask Siri®²⁴ to help you out while you drive. Get directions, make calls and send messages, and connect to Apple Music, all without pausing your drive. Available.



Bring the best of Google with you in your Uconnect system. Talk to Google on Android Auto™²⁶ and get things done with your voice so you can keep your focus on driving. Easily send messages, get directions, control media and more. Just say, "Hey Google" or long-press the voice-control button on your steering wheel. Available.

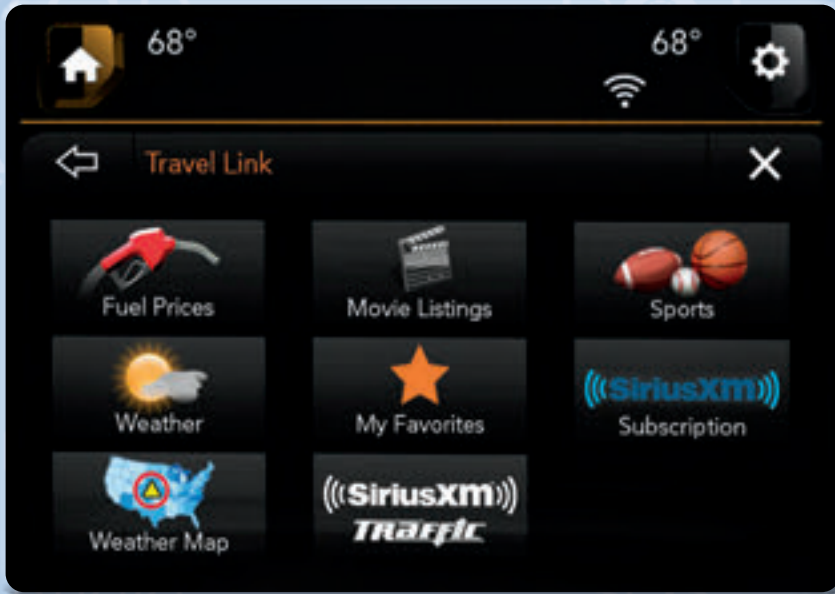

SIRIUSXM TRAVEL LINK^{28,29}

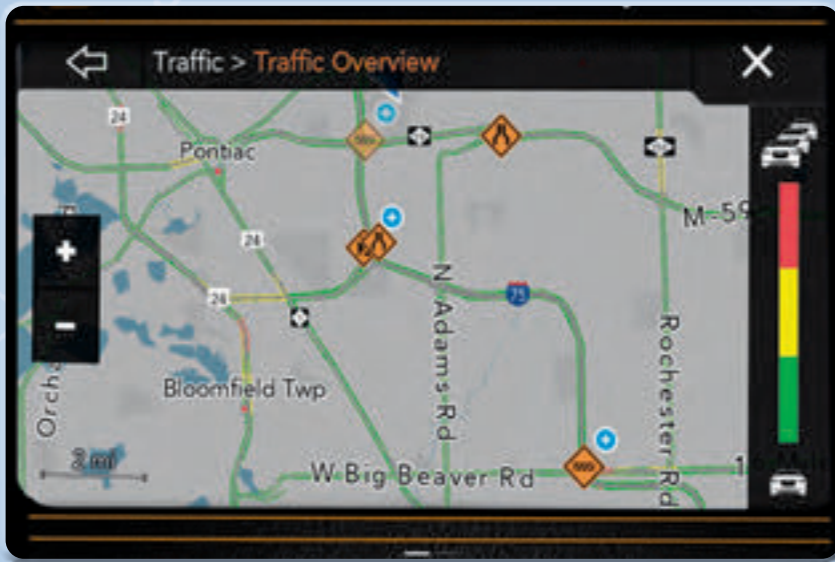

SIRIUSXM TRAFFIC PLUS²⁸

Uconnect®

Trips are enhanced with informative and entertaining apps. Access them on your Uconnect® touchscreen as well as your smartphone. Connected technology keeps you linked to a whole new world.

(((SiriusXM)))

Listen to your favorite playlist from your connected device, then flip to SiriusXM® Radio²⁷ and enjoy the best commercial-free music, plus every major sport and the biggest names in entertainment, news and comedy. You'll get over 150 channels, all at the press of a button. With the SiriusXM All Access²⁷ package, you get every channel available on your satellite radio, and you can also listen wherever you go on your portable devices with the SiriusXM App²⁷ which is included with your six-month trial. Available.

SIRIUSXM 360L²⁷ Models equipped with the available 12-inch Uconnect touchscreen offer SiriusXM 360L²⁷. In addition to delivering both satellite and streaming SiriusXM channels, 360L uses intuitive algorithms to serve up content recommendations based on your listening preferences. This makes it easier to discover more of what SiriusXM²⁷ offers, including exclusive SiriusXM²⁷ on-demand programming. You can also create your own ad-free music stations based on the artists you're listening to. Subscribers can then give songs a thumbs-up or thumbs-down within the SiriusXM²⁷ service, or even skip songs, to create their own personal channel that plays more of what they want to hear.

SiriusXM TRAVEL LINK

Access useful information when you need it, right at your fingertips. Get detailed weather maps, five-day forecasts and severe weather alerts, as well as sports scores and in-game weekly schedules on your favorite teams, information on fuel prices in your area and more. Your first five years of SiriusXM Travel Link^{28,29} service are included. Available.

SiriusXM TRAFFIC PLUS

Avoid congestion before you reach it. Get continuous updates on traffic speed, accidents, construction, road closures and more before you begin your travels. You will get to your destination faster and more easily than ever before. Your first five years of SiriusXM Traffic Plus²⁸ service are included. Available.

DRIVEUCONNECT.COM

Uconnect® + SiriusXM GUARDIAN™

SIRIUSXM GUARDIAN™³⁰ Drive worry-free with SiriusXM Guardian³⁰— a premium suite of safety and convenience services that can be accessed in-vehicle or through the Uconnect® App.²⁰ Includes a one-year trial. Available.

SIRIUSXM GUARDIAN³⁰ SERVICES³¹ + UCONNECT APP²⁰

- SOS CALL³²** In the event of an incident, push the SOS³² button. You'll be connected to a SiriusXM Guardian³⁰ agent who will contact emergency services, provide your location and stay on the line with you until help arrives.
- AUTOMATIC SOS (ASOS)** is a hands-free safety service that can immediately connect you with help in the event your vehicle's air bags³³ deploy. Seconds after the incident, a live agent will contact you through the Uconnect system and alert emergency services. If you are unable to respond, the agent can direct emergency services to your GPS location.
- ROADSIDE ASSISTANCE CALL³⁴** puts you in touch with an agent who can get you help while you're out on the road.
- LOCK/UNLOCK** your car from virtually anywhere.
- START YOUR CAR REMOTELY³⁵**
- FLASH THE LIGHTS** and sound the horn to help find your car.
- VEHICLE FINDER³⁶** allows you to locate your vehicle on a map.
- SEND & GO³⁷** enables you to send destinations to your navigation system.
- THEFT ALARM NOTIFICATION³⁸** Receive alerts by text, email or push notification if your vehicle's available theft alarm is triggered.
- STOLEN VEHICLE ASSISTANCE³⁹**
- FAMILY DRIVE ALERTS⁴⁰** Peace of mind when you hand over the keys. Allows you to set parameters to receive notifications when others are operating your vehicle. Here are just a few:
 - BOUNDARY ALERT** Be alerted the moment your vehicle is driven out of up to five geographic boundaries that you set.
 - CURFEW ALERT** Be alerted if your car is being driven outside of the curfew you set.
 - SPEED ALERT** Receive a notification whenever your car exceeds a speed limit you set.
 - VALET ALERT** Be alerted the moment your vehicle is driven outside of a defined radius.

SMARTPHONE/SMARTWATCH APP Access the features of SiriusXM Guardian³⁰ through the convenient Uconnect App,²⁰ which lets you use your smartphone or smartwatch to keep in touch with your vehicle from a distance.

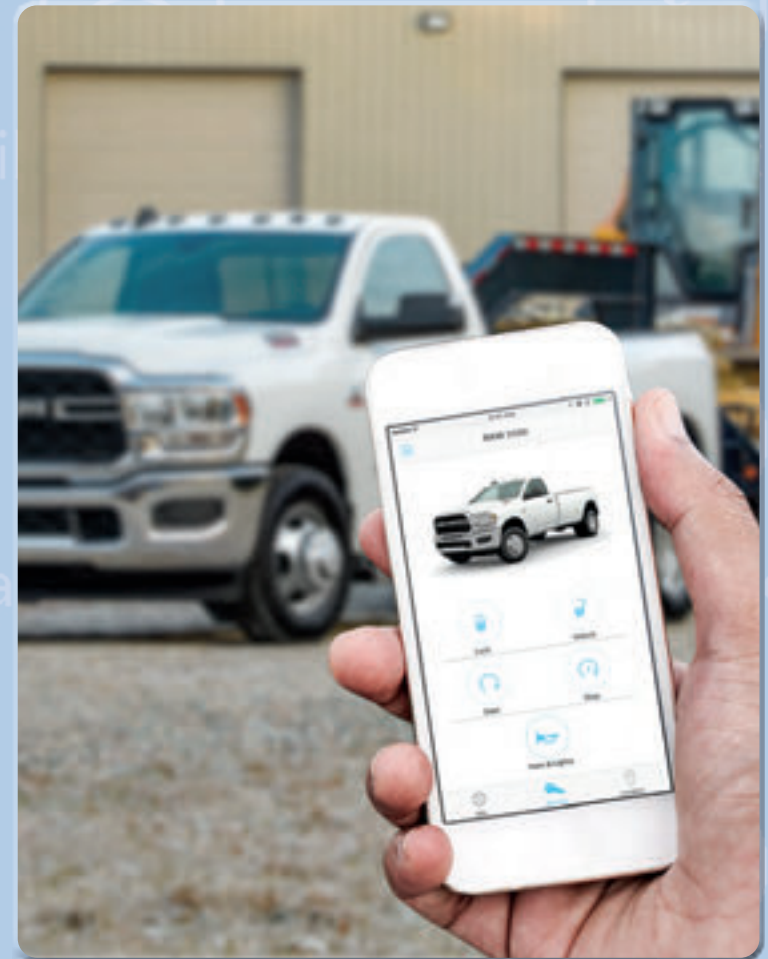

BOUNDARY ALERT



SPEED ALERT

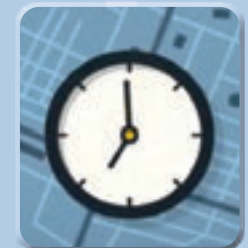

CURFEW ALERT

DRIVEUCONNECT.COM

“Alexa, ask Ram to start my truck.”

“Alexa, ask Ram how much gas is in my truck.”

“Alexa, ask Ram to find the nearest gas station.”

“Alexa, ask Ram to send [address] to my truck.”



Conveniently command your vehicle using your voice with the Ram Skill for Amazon Alexa⁴¹ on an Alexa-enabled device from the comfort of your home! Just ask Alexa to start/stop the engine, lock/unlock the doors, check fuel status or tire pressure and more. With available Uconnect[®] Navigation, you can also ask Alexa to find a business and send the address directly to your vehicle.

Hey Google, ask Ram to start my truck

Hey Google, ask Ram how much gas is in my truck

Hey Google, ask Ram to find the nearest gas station

Hey Google, ask Ram to send (address) to my truck



Remotely voice control your vehicle from any Google Assistant-enabled device with the Ram Action on Google. Simply ask Google to start/stop the engine, lock/unlock the doors, check fuel status or tire pressure and more. With available Uconnect Navigation, you can also ask Google to find restaurants, gas stations and other destinations and send the addresses directly to your vehicle for added convenience.

DRIVEUCONNECT.COM

WE HAVE YOUR BACK



FULL-TIME MONITORING OF YOUR TRAILER AND CARGO

The available Trailer Reverse Guidance¹⁹—available on 2500/3500 Heavy Duty pickups and class-exclusive on Chassis Cabs¹⁶—delivers technology that lets you watch your trailer in real time, aids in parking and maneuvering long or short setups, and provides greater confidence when dealing with tight loading docks. The system “stitches together” select views to create a single scene of both trailer sides; on-screen buttons let the driver pan left/right to better frame the trailer in the image when backing up. No active lines are provided.

New Trailer Reverse Steering Control—available on Ram 1500—provides easy in-cab directional control when backing up a trailer.



AUXILIARY CAMERA SYSTEM¹⁹

This available Mopar[®] system allows you to determine the optimal position of the camera on your trailer. Ample wiring will handle trailers up to 40 feet. This system requires the Auxiliary Camera Prep Package.



SEEING IS KNOWING



RAM 1500/2500/3500 PICKUP: 360° SURROUND-VIEW

THE AVAILABLE SURROUND-VIEW CAMERA SYSTEM¹⁹ Available on Ram 1500, Heavy Duty 2500/3500 and all Chassis Cab models, the Surround-View Camera System¹⁹ assembles images from multiple cameras to provide a “stitched-together” view as from above. It delivers a complete picture to the driver—especially helpful when parking in tight spaces, preparing to load or unload, or when hooking up a trailer. Ram 1500/2500/3500 pickups display 360° visibility; on Ram Chassis Cabs, this class-exclusive feature¹⁶ delivers 270° visibility. The combination of surround-view and model-specific back-up images dramatically improves confidence and capability.



RAM CHASSIS CAB: 270° SURROUND-VIEW



THE CHMSL CAMERA¹⁹

Located in the Center High-Mount Stop Light (CHMSL), this available camera gives a high-perspective view of the vehicle rear, with the image displayed on the center-stack screen. Count on real-time views of the box cargo or in-box hitch status—like available fifth-wheel or gooseneck applications on pickups or, on all models, aftermarket upfits. (Not available on Ram 1500 models.)



THE PARKVIEW® REAR BACK-UP CAMERA¹⁹

On pickups, the tailgate-integrated camera projects a center-stack image with dynamic grid lines and a centerline; when in Reverse, the grid lines become guide paths as the steering wheel is turned. On Chassis Cabs, the camera is upfit-mounted; grid lines are not included. Depending on model, the image is displayed on the center stack or in the rearview mirror.



ADVANCED TECHNOLOGY WORKING FOR YOU



ALL-NEW DIGITAL REARVIEW MIRROR

Ram Trucks offer an impressive suite of standard and available technology that makes every ride easier and more secure.

► **Available Digital Rearview Mirror.**

 A 9.2-inch-wide LCD monitor displays real-time video from a rear-facing camera. The camera is mounted on the back of the Chassis Cab's upfit or located in the pickup's tailgate for an unobstructed view. Different from back-up cameras, the vehicle doesn't need to be in Reverse to activate, and the view is in higher resolution.

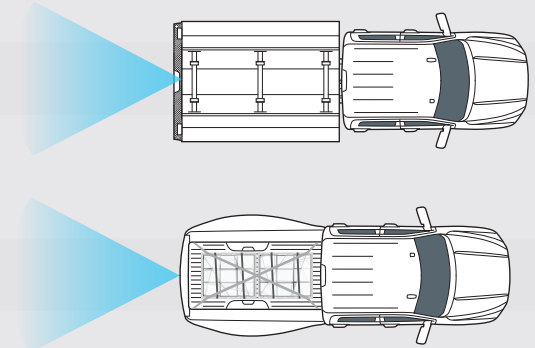

TRAILER TIRE PRESSURE MONITORING

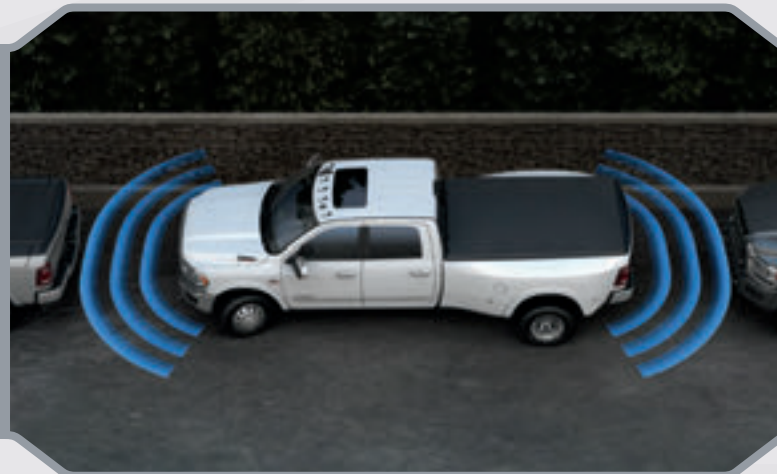

PARKSENSE® FRONT AND REAR PARK ASSIST⁴²

► **Trailer Tire Pressure Monitoring.** Available for Ram 1500, Heavy Duty and Chassis Cabs, this feature provides feedback to the cluster display for added trailering confidence.

► **ParkSense Front and Rear Park Assist.⁴²** Available sensors integrated within the front bumper and rear lower valance take the guesswork out of parking and maneuvering in tight spaces. A graphic display in the instrument cluster notifies the driver of the proximity of nearby objects.

SMART TECH WATCHING OUT FOR YOU

Every Ram Truck embraces Safety and Security—available features include:

► **Forward Collision Warning with Active Braking⁴³** detects when the vehicle is approaching another vehicle or large obstacle too quickly. It prepares the brakes for emergency braking and visually and audibly alerts the driver (including a quick “brake jerk”). If the driver isn’t braking hard or fast enough, the system will apply the brakes automatically, even bringing the vehicle to a stop if traveling under 31 mph.

► **Adaptive Cruise Control with Stop.⁴⁴** This system features full functionality between 0 and 100 mph, automatically adjusting the cruise control to a safe distance (selected by the driver) when slower traffic speeds are detected.



Shown with aftermarket upfit.

► **ParkSense[®] Front and Rear Park Assist.⁴²** It detects objects as far as 47 inches away from the bumpers; read-outs located in the gauge cluster display team up with audible chimes to notify the driver of proximity to front and/or rear objects.

► **LaneSense[®] Lane Departure Warning Plus.⁴⁵** If you begin to drift from your lane, the available LaneSense Lane Departure Warning Plus⁴⁵ helps keep you in your lane by warning you visually and adjusting your steering.



FORWARD COLLISION WARNING WITH ACTIVE BRAKING⁴³

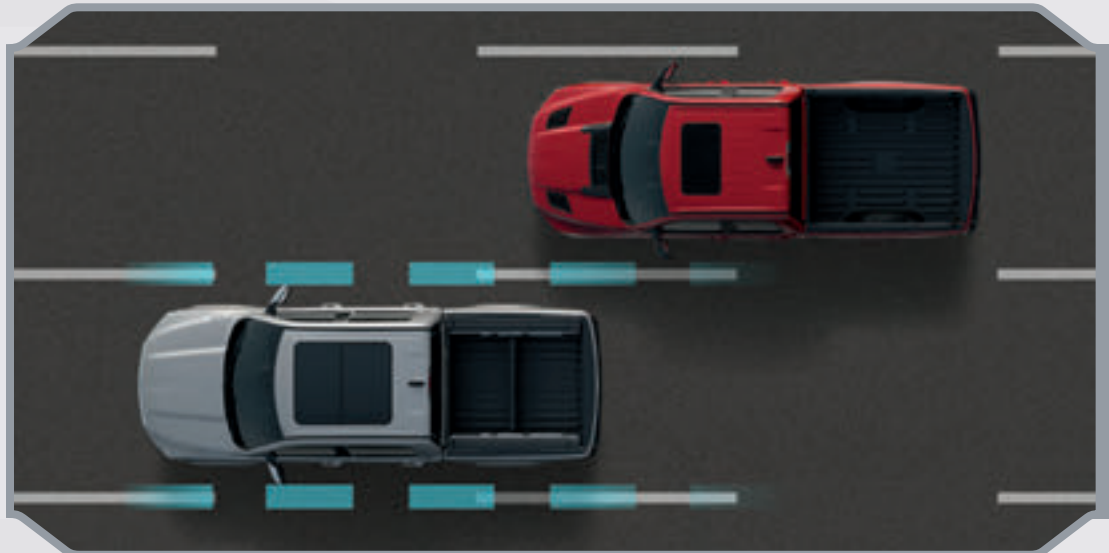

LANESENSE LANE DEPARTURE WARNING PLUS⁴⁵



ELECTRONIC STABILITY CONTROL⁴⁶ IS ON IT



All Ram Truck braking systems feature Electronic Stability Control (ESC),⁴⁶ with multiple assets including:

- ▶ **All-Speed Traction Control.** If slippage occurs during acceleration, automatic throttle control will reduce torque; in extremes, it will apply the brakes and reduce engine power to maintain control.
- ▶ **Hydraulic Boost Compensation.** Should a failure occur in the vacuum brake booster or any related line, the brake controller will run the ABS pump and convey the problem to the driver. The brakes will perform as normal until the failure is serviced.
- ▶ **Trailer Sway Damping⁴⁷** detects yaw and applies the tow vehicle's brakes to reduce the sway.
- ▶ **Rain Brake Support** automatically activates when the windshield wipers engage; brake calipers gently pulse against their rotors to remove water from the pads.
- ▶ **Electronic Brake-Force Distribution** regulates brake pressure to minimize stopping distances.
- ▶ **Ready Alert Braking** senses when the driver's foot is lifted from the accelerator; it applies an imperceptible brake force to ensure that pads and discs are lined up should an emergency stop be required.
- ▶ **Hill Start Assist.** On an incline, this system keeps the vehicle stationary for two seconds after release of the brakes or until the accelerator is depressed.

Shown with aftermarket upfit.

KEEP TRACK AND KEEP YOUR FLEET LEAN

AVAILABLE RAM TELEMATICS™ A COMPREHENSIVE SET OF DIAGNOSTICS FOR YOUR RAM COMMERCIAL VEHICLE. Scalable to fleets of all sizes, factory-installed and backed by a 3-Year/36,000-Mile Basic Limited Warranty,⁴⁹ available Ram Telematics monitors key performance metrics in near real time—the power you need to transform

your business. Tracking numerous separate mechanical functions—everything from accelerator pedal position to engine info such as coolant level and oil life monitoring—these detailed notifications help keep your Ram vehicle in top-notch condition, let your drivers make informed decisions and help increase uptime.



Shown with aftermarket upfit.



STAY ON TRACK BY KEEPING TRACK.

Simplicity plus complete visibility equals total performance. Vehicle status and history provide insight into vehicle maintenance, workforce management and driver behavior. Just a few of the many advantages:



VEHICLE DIAGNOSTICS

- ▶ Oil Life Monitoring
- ▶ Tire Pressure Monitoring
- ▶ Diagnostic Trouble Codes



VEHICLE PERFORMANCE

- ▶ Fuel Consumption
- ▶ Idling
- ▶ Odometer Readings



VEHICLE TRACKING

- ▶ GPS Location
- ▶ Geo-fencing



DRIVER BEHAVIOR

- ▶ Speeding vs. Posted Speed Limit
- ▶ Hard Braking/Acceleration
- ▶ ABS/Stability Control Events



DRIVER SAFETY & VEHICLE SECURITY

- ▶ Seat Belt Usage
- ▶ Air Bag³⁹ Deployment
- ▶ Unauthorized Vehicle Use

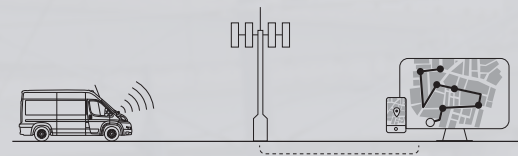

 **RAM TELEMATICS**
— POWERED BY VERIZON CONNECT —



AVAILABLE RAM TELEMATICS™: AN ON-THE-GO OPERATING SYSTEM THAT DRIVES YOUR BUSINESS. The successful business is efficient, effective, up-to-date, and stays on top of any and all technologies that will help it run better. For fleets both large and small, the state-of-the-art available Ram Telematics is the way to get the best from your Ram Commercial vehicle.

Powered by Verizon Connect, available Ram Telematics provides near real-time on-screen monitoring, provides complete visibility of fleet operations and helps reduce the total cost of ownership.



Activation is easy, with online registration and your choice from one-, three- and five-year plans available.

YOUR BUSINESS ROLLS WITH BOTTOM-LINE FIGURES. So do we. Here are just a few areas in which fleet tracking users report improvements:

Users reporting **INCREASES:**

-  **53%** PRODUCTIVITY
-  **50%** CUSTOMER SERVICE
-  **45%** ROUTING

Users reporting **DECREASES:**

-  **36%** FUEL CONSUMPTION
-  **22%** ACCIDENTS
-  **13%** LABOR COSTS

Source: "2020 Fleet Tracking Trends Report, Verizon Connect (2020).

Optimize your assets to their fullest and get the most from your Ram vehicle. Get more at ram.com/telematics

RAM TELEMATICS: HELPING DRIVE PROFITS

RAM 1500 CLASSIC PICKUP



PROVEN, CAPABLE AND REFINED. Look beyond its proven towing and hauling capability, and you'll see that the strengths of Ram 1500 Classic are also measured in comfort, in connectivity and by its classic styling—three of many reasons why the Ram 1500 Classic remains a top pick. Sleek exterior lines, impressive interiors with state-of-the-art technology and your choice of engines all add up to one pickup that will carry on when competitive models fade in the dust. Ram 1500 Classic has it: traditional style and formidable strength.

RAM 1500 CLASSIC PICKUP

AVAILABLE
MAX GCWR:
15,975 LB³

AVAILABLE
MAX GVWR:
6,900 LB³

CLASS-EXCLUSIVE Standard Link Coil Rear Suspension¹²

CLASS-EXCLUSIVE

Available RamBox[®] Cargo Management System¹²

Available Max Towing: **10,610 LB³** (HEMI[®] V8)



3.6L VVT

THE 3.6L PENTASTAR[®] V6. The engine represents excellence in performance and engineering—which includes a thermal management system that helps keep critical components operating at ideal temperatures.



HEMI 5.7 LITER

THE 5.7L HEMI V8 WITH MDS/FUEL SAVER TECHNOLOGY. Few engines carry its clout or its heritage of the innovative hemispherical cylinder head. Fewer still feature the ingenious Multi-Displacement System (MDS), which can transform the mighty V8 into an efficient yet robust 4-cylinder. Available for Ram 1500 Classic models.



INTUITIVE INSTRUMENTATION. Ram 1500 Classic controls and gauges are hand-friendly and easy on the eye. This Warlock model is all about convenience and style: steering wheel-mounted controls, six-ring instrumentation cluster, rotary dial shifter, full-color touchscreen and bright-painted accents. Shown with Apple CarPlay^{®25} integration for your iPhone[®]

CAPABLE AND VERSATILE

THE CLASS-EXCLUSIVE LINK COIL REAR SUSPENSION!² It's still one of the major engineering features that separates Ram 1500 Classic from the competition. Our long-established link coil rear suspension offers a degree of strength and durability the others can't match.

KEEP YOUR GEAR SAFE AND SECURE. Subtle storage pays off big for items best left out of sight. The available in-floor, removable bins on Ram 1500 Classic Crew Cab models come in handy for valuables and small tools.

INSTANT FLAT-FLOOR STORAGE. Quad Cab[®] and Crew Cab available rear seating areas easily convert into a true flat load floor when cargo is best transported inside.

WHERE IT COUNTS: TOWING

- ▶ Class III-rated structural rear bumper
- ▶ Available factory-installed Class IV hitch receiver
- ▶ Tow up to 10,610 lb⁹

CLASSIC FRAME STRENGTH CONTINUES

- ▶ High-strength steel core
- ▶ Eight ultra-tough crossmembers
- ▶ High-strength steel hydroformed tubular front frame unit
- ▶ Ideal for commercial-grade towing and hauling

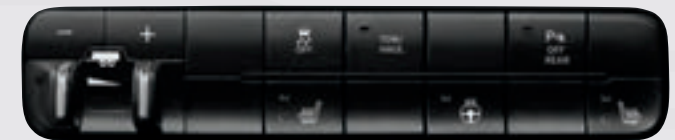

INTEGRATED SWITCH BANK

- Instant operational control over multiple areas including:
- ▶ On/off switch for the Electronic Stability Control⁴⁶ system
 - ▶ Available ParkSense[®] Rear Park Assist⁴²
 - ▶ Available Trailer Brake Controller
 - ▶ Available heated seats and heated steering wheel

RAM PROMASTER®

▶ **CLASS-EXCLUSIVE**

Available DIGITAL REARVIEW MIRROR⁹

▶ **TALLEST AND WIDEST**

Standard cargo area in its class⁹ (Cargo Van)

▶ **STANDARD**

Electronic Stability Control (ESC)⁴⁶

▶ **EXTRA PIECE OF MIND**

Available BLIND SPOT MONITORING⁴⁹ with REAR CROSS-PATH DETECTION¹⁹

▶ **ADDITIONAL ASSISTANCE**

Available FULL-SPEED FORWARD COLLISION WARNING PLUS⁴³

▶ **MONITOR IT REMOTELY**

With available Ram Telematics™

▶ **STANDARD**

PARKVIEW® REAR BACK-UP CAMERA¹⁹

▶ **FORKLIFT-FRIENDLY**

Side and rear doors welcome a standard pallet

▶ **NEAR-VERTICAL SIDE WALLS**

For custom upfits and to maximize capability

IT'S MUCH GREATER THAN THE SUM OF ITS PARTS. The nimble Ram ProMaster steps up to virtually every task out there. Consider a selection of Cargo and Windowed Vans, Chassis Cabs and Cutaways, designed to meet your exact requirements. Now in its third generation, this long-proven commercial van features standard Antilock Brake System (ABS), Traction Control, Trailer Sway Damping⁴⁷ and an available factory-installed trailer hitch for towing up to 6,910 lb⁹.

RAM PROMASTER

BEST-IN-CLASS

MAX PAYLOAD:
4,680 LB¹⁰

MAX TOWING:
6,910 LB⁹

BEST-IN-CLASS Lowest Load Floor Height⁹

BEST-IN-CLASS Standard V6 **280 hp⁹**; with 260 lb-ft of Torque

BEST-IN-CLASS Standard Cargo Height⁹

CLASS-EXCLUSIVE Standard Front-Wheel Drive (FWD)⁹

BEST-IN-CLASS 36.3-foot Turning Diameter
(118-inch Wheelbase)⁹

Max GCWR: **12,000 LB³**

Max GVWR: **9,350 LB³**

IT'S LIKE HAVING A SAFETY NET ALL AROUND YOU

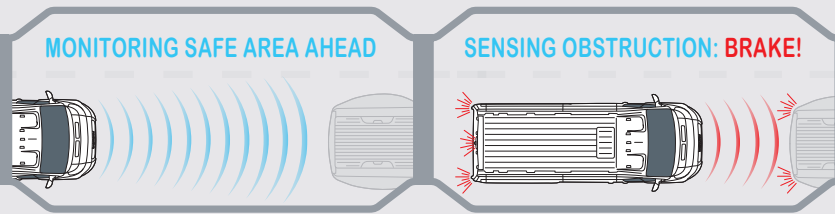

FULL-SPEED FORWARD COLLISION WARNING PLUS (FSFCW+)⁴³

The available FSFCW+⁴³ system provides both audible and visual warnings to alert the driver when it detects a potential frontal collision. The warnings are intended to provide the driver with enough time to react, avoid or mitigate the potential collision.

BLIND SPOT MONITORING (BSM)⁴⁹ WITH REAR CROSS-PATH DETECTION¹⁹

With dual wide-band radar sensors, the available BSM⁴⁹ with Rear Cross-Path Detection¹⁹ scans the blind-spot zones behind the vehicle to help ensure safe maneuvering.

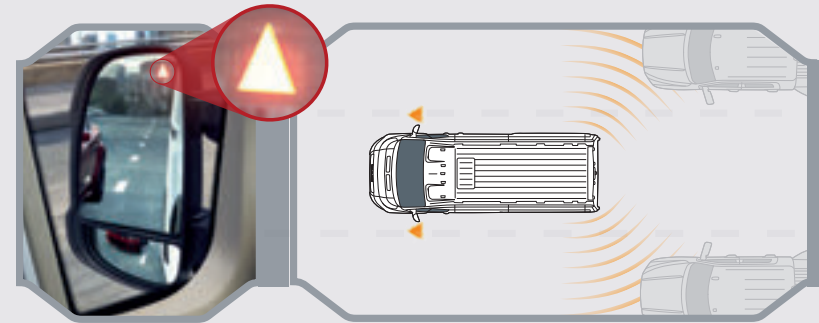

CLASS-EXCLUSIVE AVAILABLE DIGITAL REARVIEW MIRROR⁹

The new available, class-exclusive Digital Rearview Mirror⁹ replaces a traditional reflective rearview mirror with a 9.2-inch-wide LCD monitor that displays real-time video from a rear-facing camera. The camera is located on the back of the van, so the view is unobstructed. Unlike back-up cameras, the vehicle doesn't need to be in Reverse to activate, and the view is a higher resolution.

NEW STANDARD CROSSWIND ASSIST

Crosswind Assist sensors detect the forces acting on the vehicle when crosswinds or sudden gusts occur and apply braking action to individual wheels on the side facing the wind. This braking torque creates a yawing motion which counters the effect of the crosswind. The result is deviation that is significantly reduced. This decreases the strain on the driver, avoiding inappropriate driver responses in gusting winds. The driver's attention is also drawn to the system's intervention by an indicator lamp in the instrument cluster.

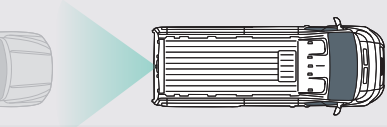
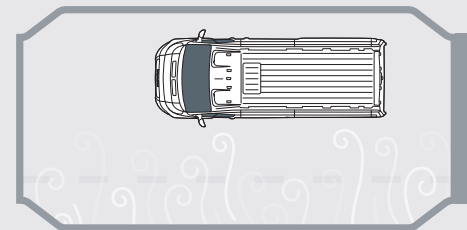

PARKVIEW[®] REAR BACK-UP CAMERA¹⁹

Standard. The camera automatically engages in Reverse, displaying the rear scene on the 5-inch radio screen display. On-screen grid lines enhance the ease of backing up.

THE RIGHT FIT FOR THE JOB

CARGO WIDTH (CARGO VAN)

BEST-IN-CLASS
MAXIMUM CARGO WIDTH⁹
(CARGO VAN)



BEST-IN-CLASS
WIDTH BETWEEN WHEEL WELLS⁹
(CARGO VAN)

2 ROOF HEIGHTS

BEST-IN-CLASS
STANDARD CARGO HEIGHT⁹
(STANDARD ROOF)



AVAILABLE HIGH ROOF



4 CARGO LENGTHS



118-inch wheelbase



136-inch wheelbase



159-inch wheelbase



159-inch wheelbase, extended



RAM PROMASTER® CARGO VAN: ONE VAN. MANY POSSIBILITIES. It's a clean slate that you'll turn into a working masterpiece. Every Ram ProMaster interior helps deliver exactly the right features that translate into a customized workspace, delivery van—or whatever suits you best. Here are just a few key workspace advantages:

- ▶ **BEST-IN-CLASS** Standard cargo height⁹ (shown here with available High Roof)
- ▶ **BEST-IN-CLASS** Maximum cargo width⁹
- ▶ **BEST-IN-CLASS** Width between the wheel wells⁹
- ▶ **BEST-IN-CLASS** Lowest load floor height⁹
- ▶ Jaw-dropping 462.9 cu ft of interior volume (with available High Roof Extended model)
- ▶ Flat load floor
- ▶ Nearly vertical walls
- ▶ Pallet-welcoming rear and side sliding doors
- ▶ Room for a 6-foot 3-inch occupant to work without stooping (with available High Roof, shown here)

Spec it out and see more at ram.com/commercial



Shown with aftermarket upfit.

CHOOSE YOUR MOBILE WORKSTATION



The Ram ProMaster® interior is spacious, designed for easy operation and features many personal touches. Among them:

- ▶ Huge windshield with solar-filter glass
- ▶ High-positioned seats for great visibility
- ▶ NEW available Interior LED Lighting Group
- ▶ Hand- and eye-friendly instrumentation
- ▶ Large glove box, multiple storage bins and cup holders
- ▶ Available overhead shelf that can hold up to 44 lb
- ▶ Numerous available seating configurations



THE NEW AVAILABLE AMBIENT LED INTERIOR LIGHTING provides additional cabin illumination and helps you make the most of your mobile workstation.

SEATING OPTIONS TO FIT YOUR BUSINESS NEEDS

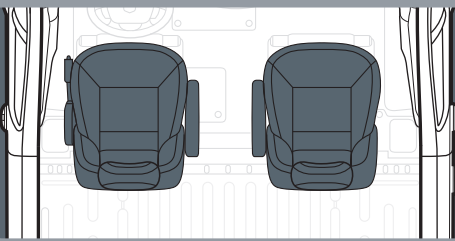

BUCKET SEATS

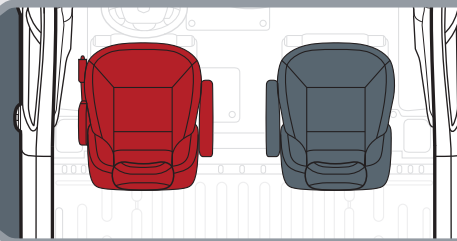

DRIVER SUSPENSION BUCKET SEAT

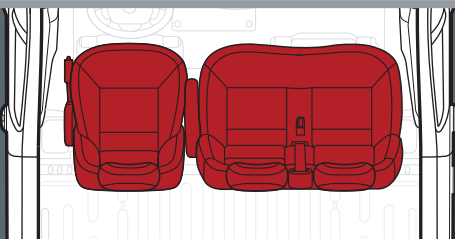

THREE-OCCUPANT SEATING

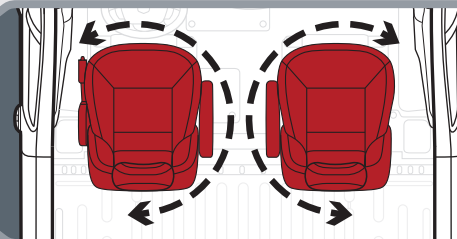

SWIVEL SEATING

BUCKET SEATS

- ▶ Standard four-way with spring suspension
- ▶ Available six-way adjustable seats with manual lumbar support and available heated seat surfaces

DRIVER SUSPENSION BUCKET SEAT

- ▶ Available premium seat adds a pneumatic suspension and a weight-/size-conformity adjustment knob

THREE-OCCUPANT SEATING

- ▶ Single driver bucket seat joined by an available integrated two-person bench seat. The middle seatback insert folds down to become a convenient writing surface

SWIVEL SEATING

- ▶ Available swivel bucket seats with 180° inboard swivel range, 35° outboard swivel, a 58° recliner and a continuous height adjuster

RAM PROMASTER CITY[®]

AMERICA'S MOST EFFICIENT WORK VAN⁵⁰



Shown with aftermarket upfit.

CARGO HAULER MEETS PEOPLE CARRIER. Every day, business owners strive to lower costs and increase efficiencies. With commercial-grade capabilities, a robust powertrain that achieves 0-30 mph in 3.7 seconds,⁵¹ must-have technology and multiple best-in-class features, Ram ProMaster City hits every target. Available in two models, each one offers customizable interiors perfectly suited for businesses, organizations, shuttles, families and weekend warriors.

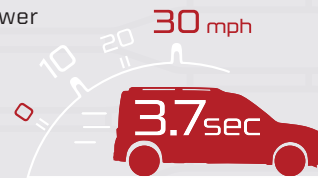

RAM PROMASTER CITY

- BEST-IN-CLASS** MAX PAYLOAD: **1,890 LB** (Cargo Van models)¹¹
- UNSURPASSED** MAX TOWING: **2,000 LB** (Cargo Van models)¹¹
- BEST-IN-CLASS** Max Cargo Capacity: **131.7 cu ft** (Cargo Van models; behind 1st row)¹¹
- BEST-IN-CLASS 178 horsepower**¹¹
- BEST-IN-CLASS 174 lb-ft of torque**¹¹
- CLASS-EXCLUSIVE** Standard **9-speed** Automatic Transmission¹¹
- CLASS-EXCLUSIVE** Bi-Link Rear Suspension¹¹
- Max GCWR: **5,900 LB**⁹



CAPABLE

- ▶ **CLASS-EXCLUSIVE Bi-Link Rear Suspension¹¹** with telescopic twin-tube hydraulic shocks and a solid 16-mm stabilizer bar for a super-comfortable ride and super-capable payload capacity
- ▶ **BEST-IN-CLASS up to 1,890-lb Payload Capacity¹¹**
- ▶ **BEST-IN-CLASS 5,395-lb GVWR^{3,11}**
- ▶ **UNSURPASSED up to 2,000-lb Towing Capacity¹¹**
- ▶ **Six Standard In-floor Tie-down Rings (Cargo Van)**
- ▶ **60/40-split Rear Doors** with the larger door on the left for easy access away from traffic
- ▶ **180° Rear Door Opening** with enough interior width to accommodate a pallet
- ▶ **Resilient Unibody Frame Design**
- ▶ **Six Integrated Roof Anchor Points**, ready for numerous aftermarket accessories, including available Silver Finish Roof Rails from Mopar® with a max rating up to 150 lb⁸

AND EFFICIENT

SMART STEERING. Hydraulic steering and Front-Wheel Drive (FWD) ensure a tight turning radius and help contribute to the low, flat load floor. Inside, the standard adjustable tilt/telescoping steering column is a welcome convenience for a commercial van.

AERODYNAMIC EXTERIOR. The thoroughly wind tunnel-tested Ram ProMaster City® boasts a sleek and super-low drag coefficient [CD] of only 0.30, which contributes to its efficiency and quiet ride.

REAL-WORLD EFFICIENCY. Reduce your time spent at the pump with ProMaster City. Cargo Van models feature best-in-class 28 mpg highway fuel economy.⁵² Drive up to 10,000 miles between recommended oil changes.



A GREAT PLACE TO WORK



Shown with aftermarket upfit.

FLAT FLOOR, NEARLY VERTICAL SIDE WALLS. These are two upfit-enabling factors that welcome customization on Ram ProMaster City®. The walls allow upfitters to efficiently install materials; the floor gives you access and freedom to design it. You'll also appreciate a low lift-in height of 23.3 inches at the rear and a step-in height of 21.5 inches at the side.

PARKVIEW® REAR BACK-UP CAMERA.¹⁹ This camera system automatically shows the rear scene in the Uconnect® 5-inch touchscreen display when in Reverse. The on-screen grid lines help when backing up to docks and trailers or into parking spaces.

PARKSENSE® REAR PARK ASSIST SYSTEM.⁴² Available sensors integrated within the front bumper and rear lower valance take the guesswork out of parking and maneuvering in tight spaces. A graphic display in the instrument cluster notifies the driver of the proximity of nearby objects.



THE WORLD IS YOUR OFFICE



Stocked with state-of-the-art electronics and communications technologies, user-friendly interfaces, and integrated storage, the Ram ProMaster City® interior functions like a production hub. The comfortable seats and easy-to-clean surfaces are as valuable as the space to spread out.

HERE ARE JUST A FEW:

- ▶ Large, standard overhead front shelf system
- ▶ Oversized glove box (176.9 cu in)
- ▶ Open, 12x4-inch in-dashboard storage bin
- ▶ Concave storage tray in front of the driver is ideal for valuables and personal devices
- ▶ Multiple storage pockets and trays around the media center
- ▶ Center console with:
 - Two cup holders
 - Two 12-volt capped auxiliary power outlets
 - USB connections for smart and intuitive charging
- ▶ Side door bins with bottle holder



OVERHEAD FRONT SHELF SYSTEM



IN-DASH STORAGE BIN AND OVERSIZED GLOVE BOX



DOOR BIN WITH BOTTLE HOLDER

POWERTRAINS

RAM 3500/4500/5500 CHASSIS CAB



360 HP/800 LB-FT

6.7L CUMMINS® TURBO DIESEL

WITH THE AISIN® HEAVY-DUTY 6-SPEED AUTOMATIC TRANSMISSION

Significant advantages come with the available Cummins Turbo Diesel—starting with available torque of 800 lb-ft. The 360-hp/800-lb-ft Cummins is partnered solely to the single transmission meant to handle this level of output over the long term: the AISIN AS69RC 6-speed automatic with its Chassis Cab-friendly available Power Take-Off (PTO) capability. This Cummins iteration is available for all Ram Chassis Cabs.



410 HP/429 LB-FT (3500 SRW 10K GVWR)

370 HP/429 LB-FT (3500 OVER 10K GVWR/4500/5500)

6.4L HEMI® V8 WITH MDS/FUEL SAVER TECHNOLOGY AND THE TORQUEFLITE® 8-SPEED AUTOMATIC OR AISIN 6-SPEED AUTOMATIC TRANSMISSION

The standard engine for all Ram Chassis Cab models provides outstanding gas-powered V8 performance with 87-octane unleaded gas. Mate the 6.4L HEMI V8 with the available AISIN 6-speed transmission, and you've got stellar available PTO capability. Configurations: HEMI V8/8HP75 8-speed, standard on 3500; HEMI V8/AISIN AS66RC 6-speed, optional on 3500 and standard on 4500/5500.



Shown with aftermarket upfit.

MDS/FUEL SAVER TECHNOLOGY

It's exactly what business needs. Engineered for the 6.4L HEMI V8 on 3500 Chassis Cab with the 8HP75 8-speed auto, the Multi-Displacement System (MDS) supplies a tough 8-cylinder for the job—and then seamlessly transforms the engine into a smooth and efficient 4-cylinder. If you're using available PTO on a 3500 Chassis Cab powered by the 6.4L HEMI V8/AISIN transmission, MDS only operates while in the stationary (static) mode.

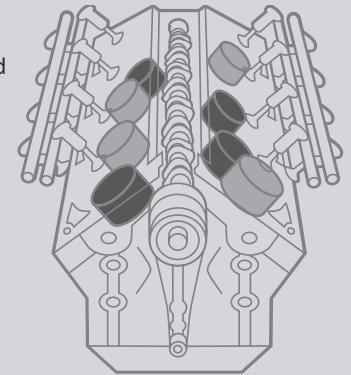

5 YEAR/100,000 MILE
POWERTRAIN LIMITED WARRANTY

EVERY DIESEL POWERTRAIN
IN THE PORTFOLIO IS COVERED
BY OUR 5/100 WARRANTY.¹⁸

5 YEAR/60,000 MILE
POWERTRAIN LIMITED WARRANTY

EVERY GAS POWERTRAIN
IN THE PORTFOLIO IS COVERED
BY OUR 5/60 WARRANTY.¹⁸

POWERTRAINS

RAM 2500/3500 PICKUP



420 HP/BEST-IN-CLASS 1,075 LB-FT⁵ (3500)

6.7L CUMMINS[®] HIGH OUTPUT TURBO DIESEL

WITH THE AISIN[®] HEAVY-DUTY 6-SPEED AUTOMATIC TRANSMISSION

The available Cummins diesel—with available torque reaching a stunning best-in-class 1,075 lb-ft⁵—delivers immense capability. Improvements for 2021 include higher limits for boost from a Variable Geometry Turbocharger and flow rate increases in the fuel delivery system. This enables the 6.7L I-6 to produce an additional 75 lb-ft of torque over the previous version while still maintaining its hallmark durability and efficiency. The Cummins HO is available only on Ram 3500 pickups.

370 HP/850 LB-FT (2500/3500)

6.7L CUMMINS TURBO DIESEL

WITH THE 68RFE 6-SPEED AUTOMATIC TRANSMISSION

This calibration translates into radically high torque output, giving Ram Heavy Duty models extra clout for the job. Like all Cummins engines, it features the “smart” diesel exhaust brake and offers superb, unaided cold-start capability in temperatures as low as -20°F. The 370-hp/850-lb-ft calibration is partnered with the dependable 68RFE 6-speed automatic transmission. Availability is solely on Ram 2500/3500 Heavy Duty pickups.



410 HP/429 LB-FT (2500/3500)

6.4L HEMI[®] V8 WITH MDS/FUEL SAVER TECHNOLOGY AND THE TORQUEFLITE[®] 8-SPEED AUTOMATIC TRANSMISSION

This engineering combines the best: Variable Valve Timing (VVT), Multi-Displacement System (MDS)/Fuel Saver Technology, Individual Cylinder Fuel Control and interactive Deceleration Fuel Shut-Off (iDFSO)—all using 87-octane unleaded. Performance is exceptional.

Technical details of the ZF 8HP75 8-speed automatic include torque-converter brazing and two gearsets with pinion gears, as well as a heavy-duty park system—all to handle the mammoth towing and payload capacities. The 8HP75 offers a level of shift refinement not usually seen in heavy-duty trucks, with fully electronic operation, an innovative and convenient rotary shifter, and on-the-fly shift mapping with more than 40 individual maps to optimize shift quality/points, regardless of load or conditions.

5 YEAR/100,000 MILE
POWERTRAIN LIMITED WARRANTY

EVERY DIESEL POWERTRAIN
IN THE PORTFOLIO IS COVERED
BY OUR 5/100 WARRANTY.¹⁸

5 YEAR/60,000 MILE
POWERTRAIN LIMITED WARRANTY

EVERY GAS POWERTRAIN
IN THE PORTFOLIO IS COVERED
BY OUR 5/60 WARRANTY.¹⁸

POWERTRAINS

RAM 1500 PICKUP



395 HP/410 LB-FT

5.7L HEMI® V8 WITH eTORQUE TECHNOLOGY AND THE TORQUEFLITE® 8-SPEED AUTOMATIC TRANSMISSION

Even an engine that carries the legendary reputation of the 5.7L HEMI V8 can achieve new-generation status. Incorporating eTorque technology in the HEMI V8 takes engineering to the next level—and radically boosts capability. eTorque increases supplemental torque by 130 lb-ft—power you'll appreciate when launching from a full stop while towing a heavy trailer. Available only for Ram 1500.



395 HP/410 LB-FT

5.7L HEMI V8 WITH MDS/FUEL SAVER TECHNOLOGY AND THE TORQUEFLITE 8-SPEED AUTOMATIC TRANSMISSION

The resilient HEMI V8 for Ram 1500 reflects its legendary heritage—but it's really the engineering that makes this the engine of choice for business. Smart refinements to get the most from every drop of fuel include dual spark plug technology and Variable Valve Timing (VVT); both contribute to outstanding engine efficiency and torque levels. The Multi-Displacement System (MDS)/Fuel Saver Technology transforms this legendary V8 into an efficient 4-cylinder under many of the everyday and specialized driving conditions in industry and agriculture. Available for Ram 1500 pickups.

**3.6L
VVT**



305 HP/269 LB-FT

THE 3.6L PENTASTAR® V6 WITH eTORQUE TECHNOLOGY AND THE TORQUEFLITE 8-SPEED AUTOMATIC TRANSMISSION

The standard powerplant is the 3.6L Pentastar V6 with eTorque—a smart configuration that delivers the welcome addition of 90 lb-ft of supplemental torque to an already impressive torque curve. eTorque technology for the Pentastar V6 is on Ram 1500 only.



260 HP/480 LB-FT

THE 3.0L ECODIESEL V6 WITH THE TORQUEFLITE 8-SPEED AUTOMATIC TRANSMISSION

The third generation of the 3.0L EcoDiesel V6 offers significant ratings across the board. It ramps up torque by 14 percent and increases horsepower by 8 percent over the previous version—while measurably minimizing Noise, Vibration and Harshness (NVH) and still maintaining outstanding efficiency. Other upgrades over the previous generation include: a new-generation water-cooled turbocharger, a redesigned cylinder head, an updated exhaust gas recirculation system design and an optimized compression ratio—from 16.5:1 down to 16:1. Available only for the 2021 Ram 1500 pickup.

**5 YEAR/60,000 MILE
POWERTRAIN LIMITED WARRANTY**

**EVERY GAS POWERTRAIN
IN THE PORTFOLIO IS COVERED
BY OUR 5/60 WARRANTY.¹⁸**

**5 YEAR/100,000 MILE
POWERTRAIN LIMITED WARRANTY**

**EVERY DIESEL POWERTRAIN
IN THE PORTFOLIO IS COVERED
BY OUR 5/100 WARRANTY.¹⁸**

POWERTRAINS

RAM 1500 CLASSIC PICKUP



395 HP/410 LB-FT

5.7L HEMI® V8 WITH MDS/FUEL SAVER TECHNOLOGY AND THE TORQUEFLITE® 8-SPEED AUTOMATIC TRANSMISSION

Nothing says capability as well as a 5.7L HEMI V8 in a Ram 1500—with a comprehensive description on the previous page. To that, add the fact that all 5.7L HEMI V8 engines are mated to the TorqueFlite 8-speed automatic transmission with its easy-to-use and dashboard-mounted rotary shifter. This is one powertrain that gives every owner of a Ram 1500 confidence, capability and character. Available for all Ram 1500 Classic pickups.

5 YEAR/60,000 MILE
POWERTRAIN LIMITED WARRANTY

**EVERY GAS POWERTRAIN
IN THE PORTFOLIO IS COVERED
BY OUR 5/60 WARRANTY.¹⁹**



**3.6L
VVT**

305 HP/269 LB-FT

THE 3.6L PENTASTAR® V6
WITH THE TORQUEFLITE 8-SPEED AUTOMATIC TRANSMISSION

As the standard powerplant on select Ram 1500 Classic pickups, the Pentastar V6 delivers ultra-capable performance with notable gas-powered efficiency working with its standard partner, the innovative TorqueFlite 8-speed automatic transmission. One of the many invaluable assets of this engine is its thermal management system—technology that helps keep internal components operating at ideal temperatures.

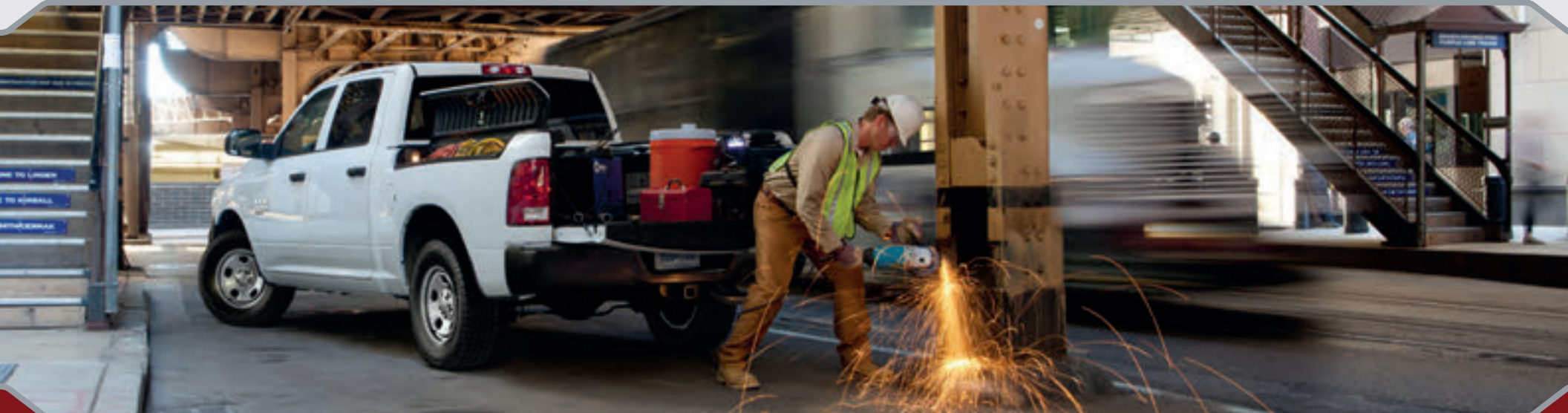

POWERTRAINS

RAM PROMASTER®

3.6L
VVT

280 HP/260 LB-FT

3.6L PENTASTAR® V6 WITH 6-SPEED AUTOMATIC TRANSMISSION

The impressive and reliable Pentastar V6 remains the preferred and standard engine for the 2021 Ram ProMaster models. Light and efficient, it features outstanding horsepower and torque curves, Electronic Throttle Control, and a serious compression ratio of 10.2:1.



5 YEAR/60,000 MILE
POWERTRAIN LIMITED WARRANTY

**EVERY GAS POWERTRAIN
IN THE PORTFOLIO IS COVERED
BY OUR 5/60 WARRANTY.¹⁸**

RAM PROMASTER CITY®

2.4L *multiair*

178 HP/174 LB-FT

**2.4L TIGERSHARK® MULTIAIR® 2 I-4
WITH 9-SPEED AUTOMATIC TRANSMISSION**











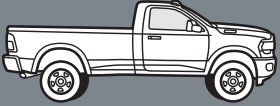



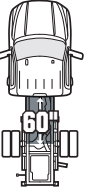

Here's what propels your business forward: the 2.4L Tigershark mated to the 9-speed automatic transmission; working together, these components create a powertrain that delivers hardworking horsepower and torque figures along with notable 4-cylinder efficiency.

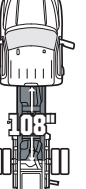

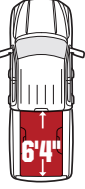
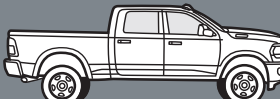
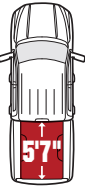
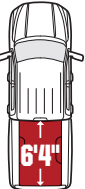
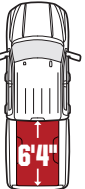



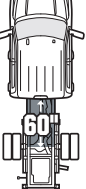
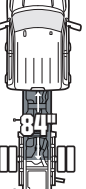
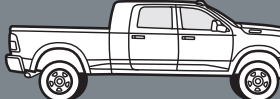
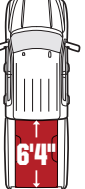
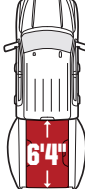









5 YEAR/60,000 MILE
POWERTRAIN LIMITED WARRANTY



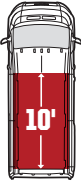

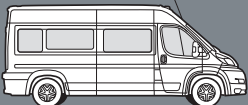
**EVERY GAS POWERTRAIN
IN THE PORTFOLIO IS COVERED
BY OUR 5/60 WARRANTY.¹⁸**

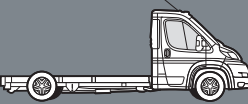
CONFIGURATIONS – PICKUP AND CHASSIS CAB

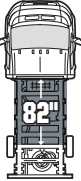
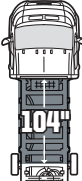
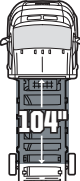
	RAM PICKUP				RAM CHASSIS CAB				
	1500		2500 AND 3500		3500, 4500 AND 5500				
	SRW		SRW	DRW	SRW	DRW			
 <p>REGULAR CAB</p>	 <p>1500 CLASSIC ONLY</p>	 <p>1500 CLASSIC ONLY</p>	 <p>2500, 3500</p>	 <p>3500</p>	 <p>3500</p>	 <p>3500, 4500, 5500</p>	 <p>3500, 4500, 5500</p>	 <p>4500, 5500</p>	 <p>4500, 5500</p>
 <p>QUAD CAB®</p>									
 <p>CREW CAB</p>			 <p>2500, 3500</p>	 <p>2500, 3500</p>	 <p>3500</p>	 <p>3500</p>	 <p>3500, 4500, 5500</p>	 <p>4500, 5500</p>	
 <p>MEGA CAB®</p>			 <p>2500, 3500</p>	 <p>3500</p>	<p>RAMBOX® SYSTEM AVAILABILITY: 1500 CLASSIC PICKUP REG, QUAD & CREW CAB, 5'7" & 6'4" BOX</p> <p>1500 PICKUP CREW CAB, 5'7" BOX</p> <p>2500/3500 PICKUPS SRW CREW AND MEGA CAB, 6'4" BOX</p>		<p> = BED LENGTH</p> <p> = CAB-TO-AXLE LENGTH</p> <p>SRW = SINGLE REAR WHEEL</p> <p>DRW = DUAL REAR WHEEL</p>		

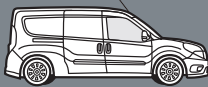
CONFIGURATIONS – RAM PROMASTER® AND PROMASTER CITY

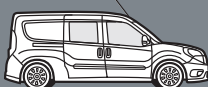
RAM PROMASTER							
	1500		2500		3500		
	118" WB	136" WB	136" WB	159" WB	136" WB	159" WB	159" WB, EXT
 <p>CARGO VAN STANDARD ROOF</p>							
 <p>CARGO VAN AVAILABLE HIGH ROOF</p>							
 <p>WINDOWED VAN HIGH ROOF ONLY</p>							
 <p>CHASSIS CAB/ CUTAWAY STANDARD ROOF ONLY</p>	<div style="border: 1px solid red; padding: 5px;"> <p> = LOAD FLOOR LENGTH</p> <p> = CAB-TO-AXLE LENGTH</p> <p>WB = WHEELBASE</p> </div>						

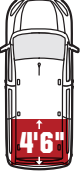
RAM PROMASTER CITY®		
 <p>CARGO VAN 122.4" WHEELBASE</p>	 <p>CARGO LOAD FLOOR</p>	
 <p>PASSENGER WAGON 122.4" WHEELBASE</p>	 <p>CARGO LOAD FLOOR 2ND-ROW SEATS FOLDED</p>	 <p>CARGO LOAD FLOOR BEHIND 2ND-ROW SEATS</p>



RAM.COM/COMMERCIAL

WE'VE GOT YOUR BACK



THE DEALER NETWORK FOR YOUR BUSINESS.

Your **BusinessLink** dealer is committed to providing you, the small business owner, with the vehicle support you need for your business, from servicing all makes and models of your existing lineup to selling you the right vehicles needed to perform the work that you do. Your **BusinessLink** dealer provides priority service because we know downtime is costing you money. Your **BusinessLink** dealer has sales professionals trained to properly "job-rate" the right vehicle for your work application along with providing commercial finance options. New vehicle sales to qualified small business owners also receive a free alternate transportation contract in the event your vehicle is in for service.

Membership is free. Membership helps us to identify you as a small business owner so we can provide you with both the service you deserve and update you with offers that can help reduce the cost of doing business. Ask your **BusinessLink** dealer to register today.

BusinessLink has you covered.

- ▶ Full Range of FCA US Commercial Vehicles
- ▶ Free Membership
- ▶ Priority Service
- ▶ Extended Service Hours
- ▶ Dedicated Staff of Commercial Vehicle Experts
- ▶ Free Alternate Transportation
- ▶ Commercial Incentives
- ▶ Expertise in Commercial Financing Options
- ▶ 24/7 Towing Service Available

ON THE JOB

INCENTIVES FOR SMALL BUSINESSES.

Running a business presents plenty of challenges. Like cutting costs, not corners. Like saving time and money and eliminating hassles. The ON THE JOB⁵³ commercial incentive program provides assistance in customizing and servicing your business vehicles.

ON THE JOB⁵³ allowances make your business more profitable!

- ▶ UP TO \$1,000. Commercial Graphics Program Allowances⁵⁴
- ▶ UP TO \$1,000. Commercial Equipment/Upfit Allowances⁵⁵

CHRYSLER CAPITAL

A commercial line of credit from Chrysler Capital is ideal for qualified business customers looking for a flexible, easy way to manage growing vehicle needs. Chrysler Capital streamlines the process—and, with pre-qualification, you're ready to buy a vehicle when you need it. Ask your **BusinessLink** dealer for details.

For more information, go to [FCAUSFLEET.COM/PROGRAMS/BUSINESS-LINK-DEALERS.HTML](https://www.fcausfleet.com/programs/business-link-dealers.html) or call us toll-free at **877-2THELINK (877-284-3546)**.

RAM NETWORK



RAM

Join fellow Ram enthusiasts and tell your story by posting comments, participating in discussions, and sharing your photos and videos. Join our community on Facebook, Twitter, YouTube and Instagram.

Explore Ram Life at ram.com/ram-life.html

JOIN IN



RAM OUTFITTER



YOUR GO-TO ONLINE SOURCE FOR RAM GEAR: ram.com/outfitter

1 Based on Class 4 pickup-based conventional cab chassis. When properly equipped. See dealer for details. 2 Based on Class 5 pickup-based conventional cab chassis. When properly equipped. See dealer for details. 3 Assumes properly equipped vehicle and 150-lb allowance for driver. Additional options, equipment, passengers and cargo weight must be subtracted. See dealer for details. 4 Based on the average of Vehicles in Operation vs. New Registrations for each model year using IHS Markit Data as of July 1, 2020 for Model Years 1988 - 2020. 5 Class based on 250/2500 and 350/3500 pickups. When properly equipped. See dealer for details. 6 Based on awards within the Light-Duty Pickup segment from 3rd-quarter 2019 - 3rd-quarter 2020. 7 Class based on light-duty pickups. When properly equipped. See dealer for details. 8 When properly equipped. See dealer for details. 9 Class is based on Large Commercial Van segment (Class 2). 10 Class is based on Large Commercial Van segment (Class 2). When properly equipped. See dealer for details. 11 Class is Small Commercial Van segment (Class 1). When properly equipped. See dealer for details. 12 Class based on light-duty pickups. Excludes other FCA US LLC vehicles. 13 Based on Class 4 - 5 pickup-based conventional cab chassis. 14 Based on Class 3 - 5 pickup-based conventional cab chassis. 15 Based on Class 3 - 5 pickup-based conventional cab chassis. This system is a driver convenience system, not a substitute for active driver involvement. The driver must remain aware of traffic conditions and be prepared to use the brakes to avoid collisions. 16 Based on Class 3 - 5 pickup-based conventional cab chassis. Always check entire surroundings visually before proceeding. 17 Based on Class 3 pickup-based conventional cab chassis. 18 Visit Mopar.com for complete details and a copy of the Powertrain Limited Warranty. 19 Always check entire surroundings visually before proceeding. 20 You are responsible for using remote features in accordance with any laws, rules or ordinances in effect in your vehicle's location. You must have an active subscription to SiriusXM Guardian in order to use remote services. See Terms of Service for service limitations. 21 The Uconnect Phone requires a mobile phone equipped with the Bluetooth Hands-Free Profile. To check phone compatibility, please visit UconnectPhone.com. 22 Voice Text Reply feature requires a compatible mobile device that supports text messaging and Bluetooth. Visit UconnectPhone.com for system and device compatibility. 23 Three-month/1GB trial included with the purchase or lease of a new vehicle. Upon expiration of the trial period, purchase of a subscription is required. WiFi Hotspot available through third-party subscription. Requires Internet-enabled mobile device. See dealer for details. This feature is not intended for use by the driver while the vehicle is in motion. Always drive carefully. 24 Requires an iPhone with Siri. Certain features are not available while the vehicle is in motion. iPhone must be within active cellular range. Customer's existing iPhone data rates apply to Internet-supported features. 25 Requires compatible iPhone. See dealer for phone compatibility. Data plan rates apply. Vehicle user interface is a product of Apple. Apple CarPlay, Apple Watch, iTunes and Siri are trademarks of Apple Inc. iPhone is a trademark of Apple Inc., registered in the US and other countries. Apple terms of use and privacy statements apply. 26 To use Android Auto on your phone screen, you'll need an Android phone running 6.0 or higher and the Android Auto App. Google, YouTube, Android Auto, Google Maps and other marks are trademarks of Google LLC. 27 Your service will automatically stop at the end of your trial subscription unless you decide to continue service. If you do not wish to enjoy your trial, you can cancel by calling the number below. If you decide to continue service after your trial, the subscription plan you choose will automatically renew thereafter and you will be charged according to your chosen payment method at the then-current rates. Fees and taxes apply. See the SiriusXM Customer Agreement at siriusxm.com for complete terms and how to cancel, which includes calling 1-866-635-2349. All fees, content and features are subject to change. SiriusXM with 360L: Certain features and/or content may not be available unless an active data connection is enabled in the vehicle. Content varies by subscription package. 28 SiriusXM Traffic Plus/SiriusXM Travel Link require a subscription sold separately, or as a package, by Sirius XM Radio Inc. If you decide to continue service after your 5-year trial included with the new vehicle purchase, the subscription plan you choose will automatically renew thereafter and you will be charged according to your chosen payment method at then-current rates. Trial service is not transferable. Fees and taxes apply. Please see the Customer Agreement at siriusxm.com for complete terms and how to cancel, which includes calling 1-866-635-2349. All fees and programming are subject to change. Not all vehicles or devices are capable of receiving all services offered by SiriusXM. Data displays and individual product availability vary by vehicle hardware. Current information and features may not be available in all locations, or on all receivers. Weather Forecast. Current Conditions may not be available in all locations. 29 This feature does not work while the vehicle is in motion. 30 All SiriusXM Guardian equipped vehicles come with a 12-month complimentary trial effective on the date of purchase or lease of a new vehicle. Enrollment in the trial is required to receive service. Upon expiration of the trial period, purchase of a subscription is required to continue SiriusXM Guardian. SiriusXM Guardian is available only on equipped vehicles purchased within the United States and Puerto Rico. Services can only be used where cellular coverage is available. See Uconnect and SiriusXM Guardian Terms of Service for complete service limitations. 31 Remote Vehicle Start is not available on all vehicles. You are responsible for using remote features in accordance with any laws, rules or ordinances in effect in your vehicle's location. You must have an active subscription to SiriusXM Guardian in order to use remote services. See Terms of Service for service limitations. 32 In the event of a medical or other emergency, press the SOS button to be connected to a Customer Care agent who can direct emergency assistance to your vehicle's location. 33 Always sit properly in designated seating positions with seat belts securely fastened at all times. 34 Roadside Assistance Call connects you with an agent who will provide Roadside Assistance Service. Vehicle must be within the United States, Puerto Rico or Canada and have network coverage. Additional roadside assistance charges may apply. Check warranty for details. 35 Remote Vehicle Start is not available on all vehicles. You are responsible for using remote features in accordance with any laws, rules or ordinances in effect in your vehicle's location. 36 To use Vehicle Finder, you must have the Uconnect App with SiriusXM Guardian installed on a compatible smartphone and have an active subscription to SiriusXM Guardian. 37 Send 6 Go requires a vehicle equipped with Navigation. To use Send 6 Go, you must have the Uconnect App with SiriusXM Guardian installed on a compatible smartphone and have an active subscription to SiriusXM Guardian. 38 Theft Alarm Notification is compatible with factory-installed alarms only. 39 Stolen vehicle police report required. 40 Available only on equipped vehicles with an active subscription to SiriusXM Guardian connected services (Family Drive Alerts is not available on vehicles with 12-inch touchscreen). All SiriusXM Guardian equipped vehicles come with a 12-month trial of the full suite of services effective on the date of purchase or lease of a new vehicle. Enrollment in the trial is required to receive service. Upon expiration of the trial period, purchase of a subscription is required to continue services. Services can only be used within the United States and Puerto Rico where cellular coverage is available. 41 Available on properly equipped vehicles with a Uconnect 4C/4C NAV system. Requires a WiFi Hotspot plan and linked Amazon account to run Alexa in the vehicle. Amazon, Alexa and all related logos and marks are trademarks of Amazon.com, Inc. or its affiliates. 42 Always look before proceeding. An electronic drive aid is not a substitute for conscientious driving. Always be aware of your surroundings. 43 This system is an alert system for the front of the vehicle. It is not a substitute for active driver involvement. The driver must remain aware of traffic conditions and be prepared to use the brakes to avoid collisions. 44 This system is a driver convenience system, not a substitute for active driver involvement. The driver must remain aware of traffic conditions and be prepared to use the brakes to avoid collisions. 45 This system is a driver convenience system, not a substitute for active driver involvement. The driver must remain aware of traffic conditions and maintain control of the vehicle. 46 Always drive carefully, consistent with conditions. Always wear your seat belt and obey traffic laws. 47 Always drive carefully, consistent with conditions. 48 Visit Mopar.com for complete details and a copy of the Basic Limited Warranty. 49 Always check visually for vehicles prior to changing lanes. 50 Based on best-in-class cargo capacity, best-in-class payload and best-in-class hwy mpg. Class is Small Commercial Van segment (Class 1). 51 Based on manufacturer testing. Always drive carefully, consistent with conditions. Always wear your seat belt and obey posted speed limits. 52 Class is Small Commercial Van segment. EPA-estimated 28 hwy mpg, 2.4L automatic 9-speed transmission. Actual mileage may vary. 53 ON THE JOB is a retail incentive program; see your dealer for official rules. Inquire about eligibility by calling 877-ONTHEJOB or by logging on to fcausfleet.com/programs/business-link-dealers.html. The purchaser or lessee must be a qualified commercial customer for more than 30 days prior to the date of the vehicle purchase. An official ON THE JOB Customer Acknowledgment Form must be signed by the customer (provided by the dealer). 54 Allowance varies by graphic program. See dealer for details. Take retail delivery by 01/03/2022. 55 Allowance varies by upfit and model. See dealer for details. Take retail delivery by 01/03/2022.

©2020 FCA US LLC. All Rights Reserved. Ram, Mopar, BusinessLink 6 design, HEMI, Mega Cab, ParkSense, ParkView, Pentastar, Quad Cab, the Ram's Head Logo, RamBox, Ram ProMaster, Ram ProMaster City, Tigershark, TorqueFlite, Tradesman and Uconnect are registered trademarks and Active-Level, On The Job 6 design, Ram 1500 Classic Warlock and Ram Telematics are trademarks of FCA US LLC. Chrysler Capital is a registered trademark of FCA US LLC and licensed to Santander Consumer USA Inc. MultiAir is a registered trademark of C.R.F. Società Consortile per Azioni, used under license by FCA US LLC.

Harman Kardon is a registered trademark of Harman International Industries, Inc. Cummins is a registered trademark of Cummins, Inc. AISIN is a registered trademark of Aisin Seiki Co., Ltd. CNH, Case IH and New Holland are registered trademarks of CNH America LLC. Bluetooth is a registered trademark of Bluetooth SIG, Inc. Sirius XM Connected Vehicles Services Inc, Sirius, XM, SiriusXM and SiriusXM Guardian and all related marks and logos are registered trademarks of Sirius XM Radio Inc. Facebook and logo are registered trademarks of Facebook, Inc. The Twitter logo is a service mark of Twitter, Inc. Instagram and logo are registered trademarks of Instagram, Inc. Katerack is a registered trademark of Dejana Truck & Utility Equipment Co. All rights reserved. Carhartt and the Carhartt C logo are registered trademarks of Carhartt, Inc.

About this catalog: since the time of publication, some of the information you'll find in this catalog may have been updated. Ask your dealer for details. Some of the equipment shown or described throughout this catalog may be available at extra cost. Specifications, descriptions, illustrative materials and all competitive comparisons contained herein are as accurate as known at the time this publication was approved for printing. FCA US LLC reserves the right to discontinue models at any time or change specifications without notice or without incurring obligation. Options may be required in combination with other options. For the price of the model with the equipment you desire, or verification of specifications contained here, see your Ram dealer.

Ram is a registered trademark of FCA US LLC. 74-383-2123_03/21