

1973 Plymouth DUSTER / VALIANT BARRACUDA

Duster/Duster 340/Valiant/Scamp/Barracuda





Duster

Duster is that neat little car that's small enough to go anywhere, yet big enough for five passengers rather than four. Rugged unibody construction cuddles you in solid comfort. Torsion-bar front suspension gives road car handling characteristics. Big, economical Slant Six or 318 V-8 engine runs on no-lead or regular gas.

Extra care in engineering . . . it makes a difference.



Duster & Duster 340

The standard Duster and the sleek Duster 340 are engineered to the needs of today's market. Nimble in traffic. Solid on the expressway. Our best seller for two years. Smart new grille and hood. New taillight treatment. New extra-protection bumper system, front and rear. New colors and trim. And, nice things can be added: sun roof . . . bucket seats . . . vinyl roof . . . air conditioning.

Background: Duster 340 Foreground: Duster
Extra care in engineering . . . it makes a difference.



Valiant & Scamp

Valiant, the 13-year veteran of the compact field and still going strong. The 4-door Valiant is another name for value. Economical to buy. Economical to own. Scamp, a true 2-door hardtop, has a little longer wheelbase than Valiant and Duster, and carries its own styling with dash and flair. Both cars sport major improvements in suspension, steering, engine mounts, and engine emission controls. Extra care in engineering . . . it makes a difference.

Background: Valiant Foreground: Scamp

Duster/Valiant/Barracuda Interiors



Duster/Valiant/Barracuda Interiors

A. The new standard Barracuda and 'Cuda all-vinyl bucket seat is of an entirely new construction, and comfort is engineered in with computerized analysis. Spring deflection, stress

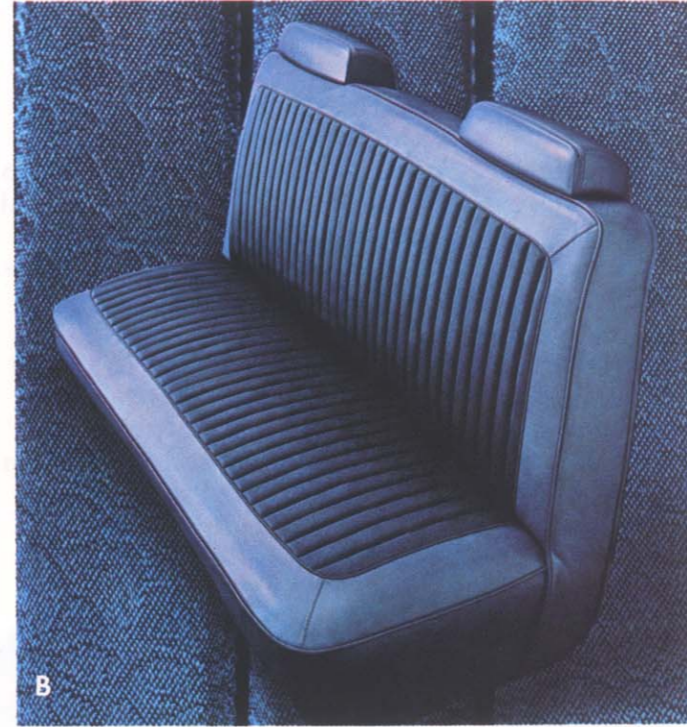

levels, and fatigue characteristics are carefully correlated for ideal support and comfort. Color availabilities are blue, green, black, and white. **B.** The new applied headrest bench seat in cloth-and-vinyl is an optional choice on the 4-door Valiant and comes in blue, green, gold, and black. **C.** The standard Duster and Duster 340 cloth-and-vinyl bench seat with integral head restraints comes in blue, green, and black/white. **D.** The basic Valiant sedan vinyl bench seat with integral head restraints comes in blue, green, and black. Also available, but not shown, is an optional Duster and Duster 340 all-vinyl bucket seat. Colors: white, parchment, and black.

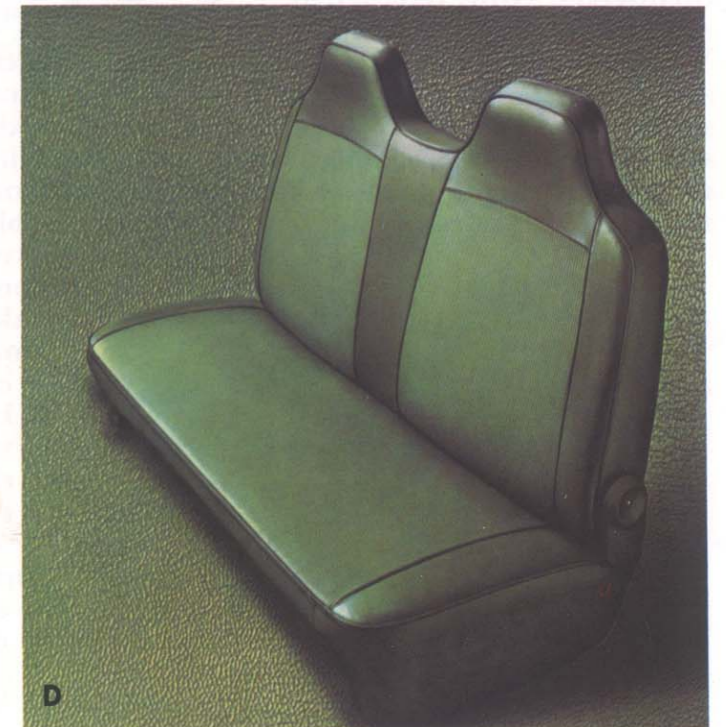

Duster/Valiant/Barracuda Interiors

You probably think of seats and trim in your new car as the "furniture" of the car. And, as such, they are both good looking and comfortable. The compact/sporty cars in Chrysler's stable give you interior design-decor that will please you.

For instance: Below is our new center armrest bench seat in pleated vinyl. Optional on all Valiants in blue, green, black or parchment. This style is also available in a cloth-and-vinyl version for the Valiant Scamp hardtop in parchment only. To the right is our new applied head-rest bench seat in pleated vinyl. Available in blue,

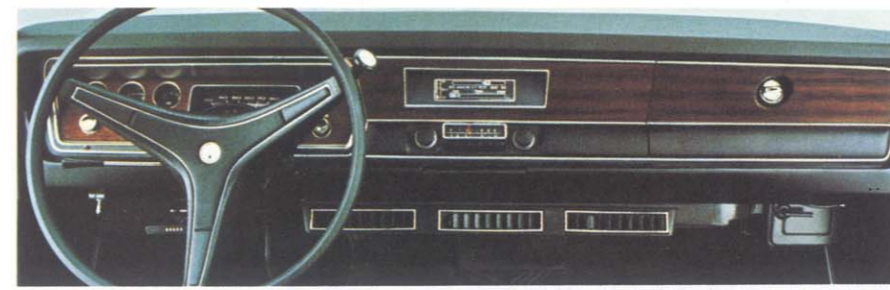

green, parchment, black, and gold. Standard on Scamp and optional on Duster. The instrument panel, shown at the top, features simulated wood-grain highlights. It's standard on the Scamp and is optional dress-up for Duster and Valiant models.



Extra care in engineering . . . it makes a difference.



'Cuda & Barracuda

Sporty appearance and sporty performance. Barracuda and 'Cuda both come equipped with the 318 V-8 . . . a 340 V-8 is optional. Power front disc brakes, standard on the 'Cuda, Electronic Ignition System, bucket seats, unibody construction on both cars—plus a heavy-duty suspension system including front and rear sway bars and F70 x 14" white sidewall tires on 'Cuda.

Dress-up options—sporty body side tape, Barracuda sports decor group, rallye wheels, chrome road wheels, vinyl roof, console.

Background: Barracuda Foreground: 'Cuda
Extra care in engineering . . . it makes a difference.

Features—New and Important to You.

Choosing a Valiant, Duster, Scamp or a Barracuda means you like the compact feel and handling, yet don't want to give up style and comfort.

The short wheelbase, torsion-bar suspension and compact body insure nimble roadability and parking ease, while unibody construction helps make these cars tough and strong.

Torsion bars have been a feature of Chrysler products for over a decade, and have proved themselves. Now, redesigned suspension elements on the Valiant 8-cyl. 318 models accommodate the new standard slider-type disc brakes, and subsequent steering modifications result in improved suspension and stronger steering components.

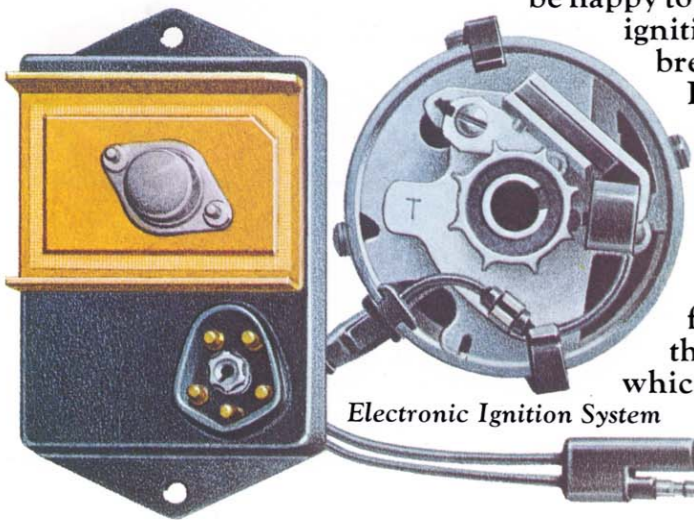

Electronic Ignition System

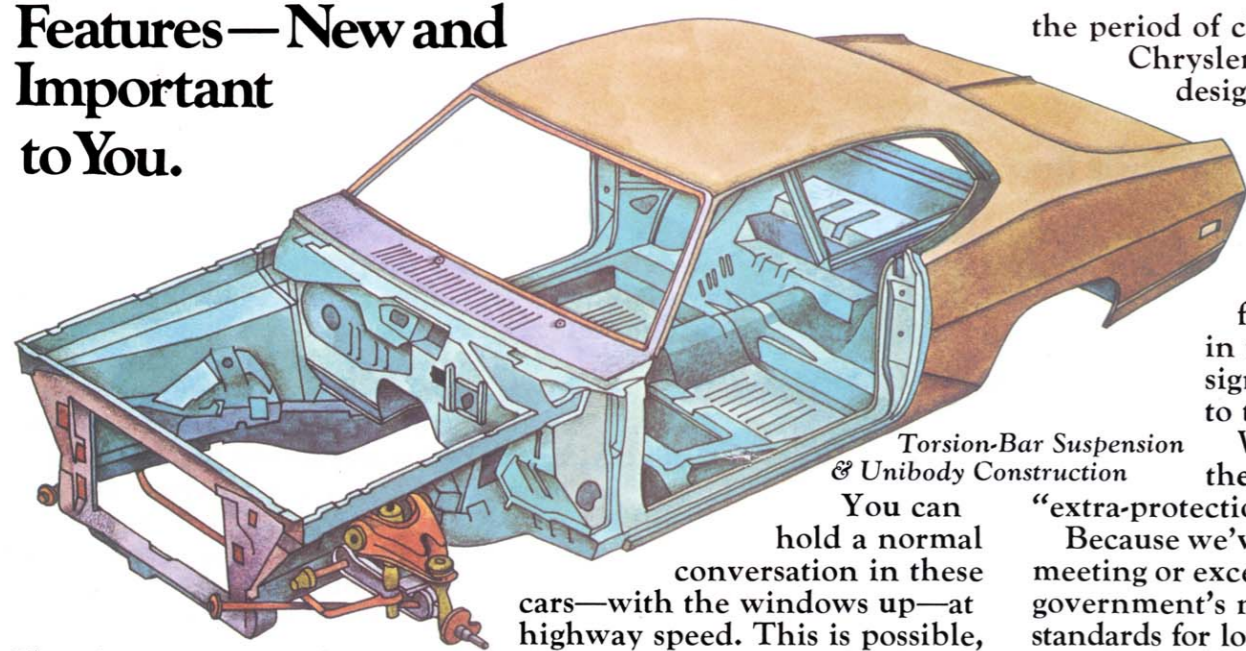

Torsion-Bar Suspension & Unibody Construction

You can hold a normal conversation in these cars—with the windows up—at highway speed. This is possible, due in part, to our unibody construction which utilizes thousands of welds to unite structural members of the body into a rugged single unit that minimizes rattles and squeaks.

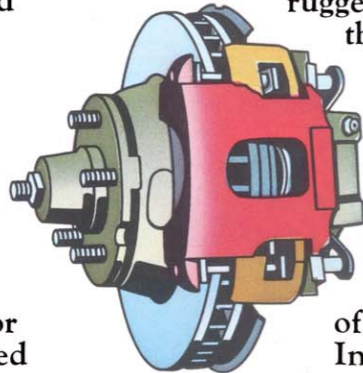

Front Disc Brakes

Also, new seals and weather strips add a new dimension of quiet. Introduced last year as an option, the Chrysler Electronic Ignition System is standard on all domestic models. This system does away with breaker points and condenser—a normal trouble source. You'll be happy to know that electronic ignition is an ecological breakthrough, too.

Engine misfiring, caused by old breaker points, is virtually eliminated thereby reducing related emissions. Emissions are further reduced by the electric assist choke which consists of a heater element in the automatic choke well to shorten

the period of choke operation. Chrysler engineers have designed an extra-protection bumper system that is capable of impacting a fixed barrier at 5 mph in the front and 2½ mph in the rear with no significant damage to the car.

Why do we call these bumpers "extra-protection"? Because we've done our job in meeting or exceeding the federal government's new damage standards for low-speed accidents. Some of the ways we accomplished this are by setting the bumper itself out from the sheet metal by as much as two inches to provide impact protection, and by locating a full-width reinforcement behind the bumper surface to provide increased beam strength during impact. There's also a bumper support structure using heavy-gauge steel with deep sections. In addition to their impact capabilities, the elastomeric bumper guards help keep your 1973 Plymouth from slipping over or under another car's bumper during a low-speed impact.

You have undoubtedly heard about the superior features of disc brakes. This added safety feature is standard on all Dusters and Valiants with V-8 engines and all Barracudas. The front disc brakes are equipped with slotted brake linings for improved braking capability



Trailer-Towing Package

With our new Spacemaker Pak the incomparable little Duster becomes a mini-wagon! Converts in seconds to give you 56 cubic feet of cargo space. That's more room than some compact wagons offer. All you do is snap the rear-seat-back forward, and open the security panel. Then you have a long carpeted space all the way back to the deck lid for cargo or a playpen. With an optional sliding sun roof, it becomes an open-air Space Duster!

reduced by about 85%, the carbon monoxides by 70% and oxides of nitrogen by 50%. We feel the "under-skin" improvements in the 1973 cars are a primary concern. However, there is nothing to say we can't make the visible elements more appealing too! And we have! For instance, new bumpers are

under continuing braking conditions. The characteristic greater fade resistance of the disc brake system is an added safety margin.

Your performance requirements are met by a choice of a Six or V-8 in all models except the Duster 340, Barracuda, and 'Cuda. The high-performance 4-barrel 340 cu. in. V-8 is standard on



Sun Roof

Duster 340 and optional on the 'Cuda and Barracuda. Valiant, Scamp, and Duster offer the choice of the 198 Six or the 318 V-8 as standard engines, with the 318 standard on the 'Cuda and Barracuda. The 225 cu. in. Six is an optional engine for Valiant models.



Spacemaker Pak



Extra-Protection Bumper System

reduced by about 85%, the carbon monoxides by 70% and oxides of nitrogen by 50%.

We feel the "under-skin" improvements in the 1973 cars are a primary concern. However, there is nothing to say we can't make the visible elements more appealing too! And we have! For instance, new bumpers are



obvious on all models, but the striking new hood and grille on the Valiant and Duster give a new character to these compacts.

Security is becoming an important concern of car owners today. Chrysler recognizes this and offers standard and optional security features for your consideration. Standard in '73 is the newly designed deck lid lock. A new steel housing for the deck lid lock improves trunk security. There's also a standard steering column ignition lock and an optional inside hood release.

A new option for 1973, in the compact line, is the trailer-towing package. Available to give Duster and Valiant a towing capacity of up to 2,500 pounds with a 318 CID engine. The trailer-towing components not only handle the load requirement, but add protective elements as well. See the 1973 Trailer-Towing Guide for details.



Cleaner Air System

With our new Spacemaker Pak the incomparable little Duster becomes a mini-wagon! Converts in seconds to give you 56 cubic feet of cargo space. That's more room than some compact wagons offer. All you do is snap the rear-seat-back forward, and open the security panel. Then you have a long carpeted space all the way back to the deck lid for cargo or a playpen. With an optional sliding sun roof, it becomes an open-air Space Duster!

Extra care in engineering . . . it makes a difference.

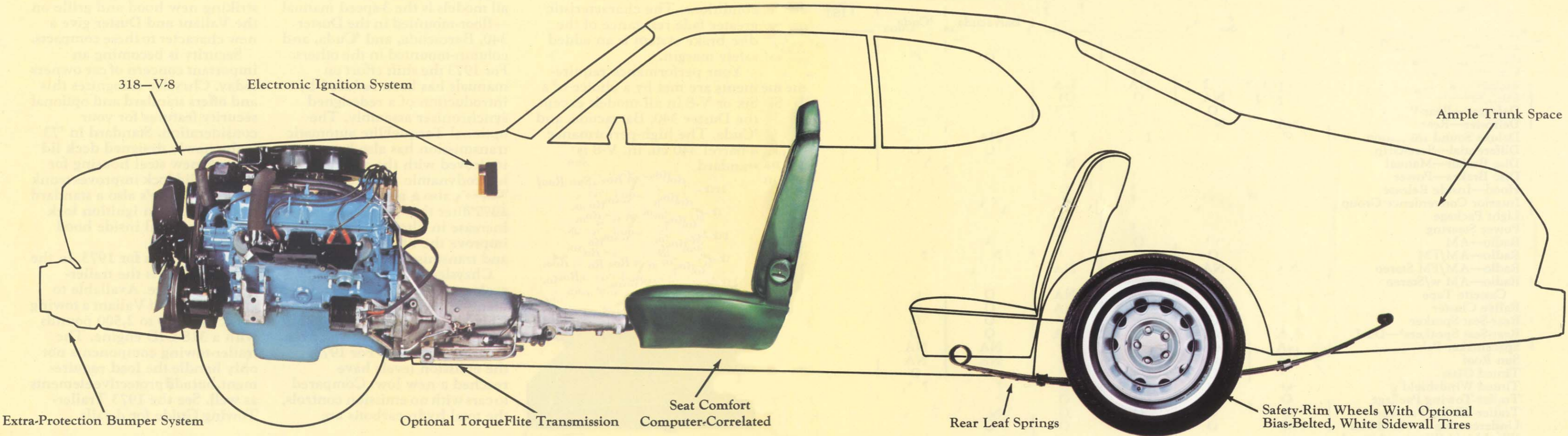

Extra care in engineering...it makes a difference.

A good example is our torsion-bar suspension. Introduced by

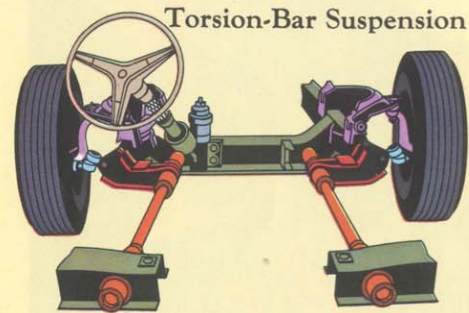

Chrysler to U.S. production cars many years ago, torsion bars help to soften road shock and smooth out bumpy roads.

The beauty of front torsion bars is their simplicity and their ability to control bumps. The principle employs the twisting movement of a steel bar to perform the springing effect of some other cars' coil springs.

In addition, unibody construction literally makes the frame

and body of a Duster, Valiant, or Barracuda a single unit. Over 4,000 welds are used to permanently weld the structure to the frame, thus lessening the possibility of squeaks and rattles, and providing a strong, secure body unit.

In addition, every body goes through our 7-step dip-and-spray process to help prevent rust. Then our new acrylic dispersion enamel is applied to make sure your car stays

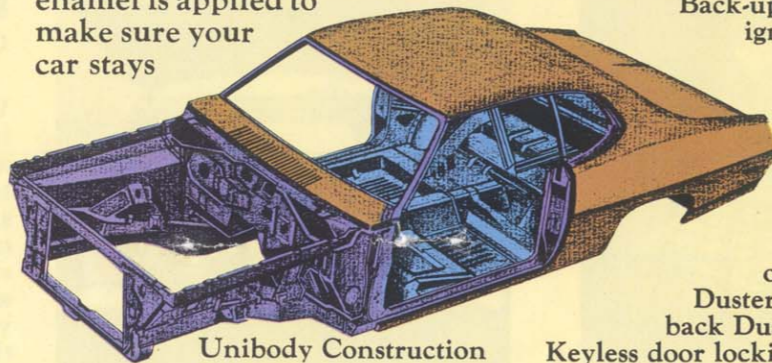

bright and shiny for a long time to come.

Duster, Valiant, Barracuda... the little cars that come through with a lot.

Duster, Valiant & Scamp Standard Features

- 198 CID Six or 318 CID V-8 engine
- 3-speed manual transmission
- Torsion-bar suspension
- Electronic Ignition System
- Electric assist choke
- Fuel gauge
- Temperature gauge
- Ammeter gauge
- Front disc brakes with V-8 engine
- Color-keyed armrests
- Swing-out rear quarter window*
- Cleaner Air System
- Ventless side glass (Duster & Scamp)
- Soft coat hooks
- Concealed spare tire
- Back-up lights
- Anti-theft ignition and steering column lock with ignition warning buzzer
- Side marker lights and reflectors
- Two-door hardtop model (Scamp only)
- Special new Duster taillights*
- Swept-back Duster body styling*
- Keyless door locking
- Hubcaps.

Duster 340

(All of the above Duster features plus these additions and changes.) 340 CID V-8 engine • 3-speed full-synchro manual transmission with floor-mounted shifter • Accent tape stripes • Roof drip rail molding • Heavy-duty suspension • E70 bias-belted tires • 5½ x 14" wheels • Heavy-duty shock absorbers • 8¾ axle • Dual exhaust.

Barracuda Standard Features

318 CID V-8 engine • Keyless door locking • Dual horns • Hubcaps (set of 4) • Inside day/night rearview mirror • Outside rearview mirror • Fuel gauge • Temperature gauge • Ammeter gauge • Torsion-bar suspension • Anti-theft ignition and

steering column lock with ignition warning buzzer • Bucket seats • Cigarette lighter • Ventless side glass • 3-speed all-synchro manual transmission with floor-mounted shifter • Color-keyed headlining and armrests • Roadlamp-styled parking lamps • Twin-circular taillights • Side marker lights and reflectors • Chrome wheel lip and sill molding** • Performance hood** • Color-keyed# grille and black rear deck panel** • Heavy-duty suspension** • Bias-belted tires**.

*Duster only **Std. on 'Cuda #In six popular colors

Standard Safety Features

New extra-protection bumper system, front and rear • Fuel-tank impact

protection • Turn signal with lane-change feature • Less flammable interior materials • Locking steering column • Energy-absorbing front seat-back and armrests • Seat belts, all seating positions • Shoulder belts, 2 front, with new 3-point hook-up • Manual inside door lock — levers with non-override lock feature, except driver's door • Interlocking door latches • Flush-type inside door release levers • Cushioned sun visors • Dual braking system with warning light • Hazard warning lights • Windshield wipers — 2-speed, electric • Locking latch on all folding front seat-backs • Left outside rearview mirror • Padded instrument panel.

Exterior Dimensions	Valiant Sedan	Scamp	Duster	Duster 340	Barracuda	'Cuda
Wheelbase	108 in.	111 in.	108 in.	108 in.	108 in.	108 in.
Overall Length	195.8 in.	199.6 in.	195.8 in.	195.8 in.	193.0 in.	193.0 in.
Overall Width	71.0 in.	71.0 in.	71.8 in.	71.8 in.	75.6 in.	75.6 in.
Overall Height—6-cyl.	54.3 in.	52.8 in.	53.1 in.	—	—	—
—V-8	54.3 in.	52.8 in.	53.1 in.	53.2 in.	50.9 in.	51.3 in.
Track—Front	59.1 in.	59.1 in.	59.1 in.	59.1 in.	60.2 in.	60.2 in.
—Rear	55.6 in.	55.6 in.	55.6 in.	55.6 in.	60.7 in.	60.7 in.

Duster/Valiant/Barracuda Options—Check off your choice with this handy option selector.

OPTIONS	CAR MODELS						CHECK LIST
	Valiant	Scamp	Duster	Duster 340	Barracuda	'Cuda	
Comfort/Convenience							
Air Conditioning	O	O	O	O	O	O	
Cigarette Lighter	O	S	O	S	S	S	
Clock—Electric	NA	NA	NA	NA	O	O	
Console	NA	NA	O	O	O	O	
Defogger—Rear-Window	O	O	O ²	O ²	O	O	
Defroster—Rear, Electric	NA	NA	O	O	NA	NA	
Deluxe Sound Insulation	O	O	NA	NA	NA	NA	
Differential—Sure-Grip	O	O	O	O	O	O	
Disc Brakes—Manual	S ¹	S ¹	S ¹	NA	S	NA	
Disc Brakes—Power	O	O	O	S	O	S	
Hood—Inside Release	O	O	O	O	O	O	
Interior Convenience Group	O	NA	O	O	NA	NA	
Light Package	O	O	O	O	O	O	
Power Steering	O	O	O	O	O	O	
Radio—AM	O	O	O	O	O	O	
Radio—AM/FM	O	O	O	O	NA	NA	
Radio—AM/FM Stereo	NA	NA	NA	NA	O	O	
Radio—AM w/Stereo Cassette Tape	NA	NA	NA	NA	O	O	
Rallye Cluster	NA	NA	NA	NA	O	O	
Rear-Seat Speaker	O	O	O ²	O ²	O	O	
Rear-Seat Speakers ³ —Dual	NA	NA	NA	NA	O	O	
Spacemaker Pak	NA	NA	O	O	NA	NA	
Sun Roof	NA	O	O	O	NA	NA	
Tinted Glass	O	O	O	O	O	O	
Tinted Windshield	O	O	O	O	NA	NA	
Trailer-Towing Package	O	O	O	O	NA	NA	
Trailer-Wiring Package	O	O	O	O	NA	NA	
Undercoating & Hood Pad	O	O	O	O	O	O	
Windshield Wipers—3-speed with Electric Washers	O	O	O	O	O	O	
Decor/Dress-up							
Bright Bumper Guards	O	O	O	O	S	S	
Carpets	O	S	O	O	S	S	
Custom Exterior Group	O	NA	O	O	NA	NA	
Hood Blackout Treatment	NA	NA	O	O	NA	NA	

O—Optional S—Standard NA—Not Available ¹ Optional with 6-cylinder engine ² Not available with Spacemaker Pak

OPTIONS	CAR MODELS						CHECK LIST
	Valiant	Scamp	Duster	Duster 340	Barracuda	'Cuda	
Decor/Dress-up (Continued)							
Hood Scoops	NA	NA	O ⁵	NA	NA	NA	
Hood—Sport	NA	NA	NA	NA	O	S	
Interior Decor Package	O	S	O	O	NA	NA	
Mirror—Dual Racing	NA	NA	O	O	O	O	
Mirror—Inside Day/Night	O	O	O	O	S	S	
Mirror—Remote Control Left	O	O	O	O	O	O	
Molding—Sill	O	O	O	O	O	S	
Molding—Vinyl Side	O	O	O	O	O	O	
Molding—Wheel Opening Lip ⁵	O	S	O	O	O	S	
Sport Decor Package	NA	NA	NA	NA	O	NA	
Tape Stripe—Body Side	NA	NA	O	S	O	O	
Tape Stripe—Lower Deck	NA	NA	O	S	NA	NA	
Tires—Whitewall	O	O	O	NA	O	S	
Tires—Raised White Letter	O	O	O	O	O	O	
Twister Package	NA	NA	O	NA	NA	NA	
Wheel Covers—Deluxe	O	O	O	O	O	O	
Wheels—Chrome Style	NA	NA	NA	NA	O	O	
Wheels—Rallye Road	O	O	O	O	O	O	
Vinyl Roof—Full	O	O	O	O	O	O	
Vinyl Roof—Canopy	NA	NA	O	O	NA	NA	
Performance							
198 Six	S	S	S	NA	NA	NA	
225 Six	O	O	O	NA	NA	NA	
318 V-8	S	S	S	NA	S	S	
340 V-8	NA	NA	NA	S	O	O	
Battery—375 Ampere	O	O	O	O	O	O	
Heavy-Duty Suspension	O	O	O	S	O	S	
Heavy-Duty Package	O	O	O	O	NA	NA	
Optional Axles	O	O	O	O	O	O	
Performance Axle Package	NA	NA	NA	NA	O	O	
Transmission—3-Speed Floor-Mounted	O	O	O	S	S	S	
Transmission— Column-Mounted	S	S	S	NA	NA	NA	
Transmission—4-Speed Manual ⁴	NA	NA	NA	O	O	O	
Transmission—TorqueFlite	O	O	O	O	O	O	

³ Available only with stereo ⁴ Available only with 340 engine ⁵ Available with Package only on Valiant, Duster & Duster 340

- A. Sun Roof.** Catch the sun and the open feeling in your Duster, Duster 340, or Scamp.
- B. Inside Hood Release.** Helps protect under-hood components from theft.
- C. Rear-Window Defroster.** Tiny electric heating elements in the glass for clear vision in winter (Dusters only).
- D. Bright Bumper Guards.** Dress-up body protection with a bright metal flair (standard on 'Cuda and Barracuda).
- E. Rallye Road Wheels.** A set of four to match your sports decor.

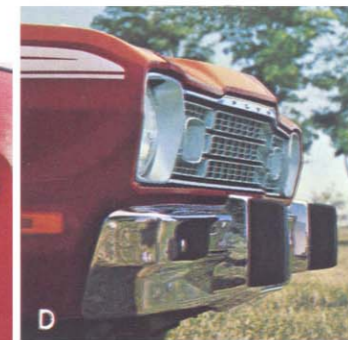
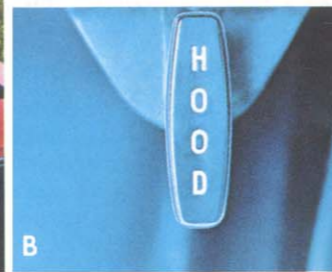

- F. Canopy Vinyl Roof.** Gives the Duster and Duster 340 that rich luxury look.
- G. & K. Radios.** Sound is today's thing! AM... AM/FM... Stereos*... Stereo tape units.* Check the options chart.
- H. Power Front Disc Brakes.** The ultimate in fade-resistant stopping power (standard with 340 engines and on 'Cuda).
- I. Twister Package.** A new special treatment on Duster for that performance look. (It says it all—you're going places!)
- J. Trailer-Towing Package.** Available on all Valiants with capacities to match power.
- L. Hurst Shifter.** A high-performance adjunct for Barracuda and Duster 340 (Barracuda shifter shown).
- M. Chrome Road Wheels.** A smart continental decor extra for Barracuda and 'Cuda.
*Barracuda and 'Cuda only



Extra care in engineering . . . it makes a difference.

DUSTER/VALIANT/BARRACUDA COLORS



Silver Frost Metallic

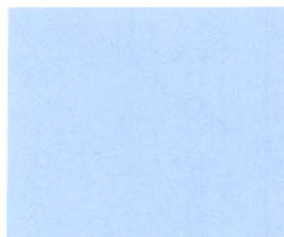

Blue Sky



Basin Street Blue



True Blue Metallic

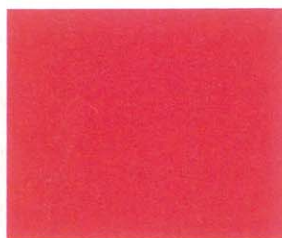

Rallye Red



Mist Green

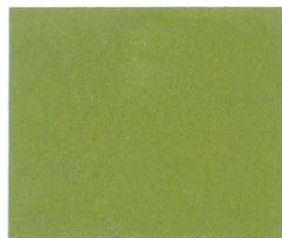

Amber Sherwood Metallic



Forest Green Metallic



Autumn Bronze Metallic



Sahara Beige



Lemon Twist*

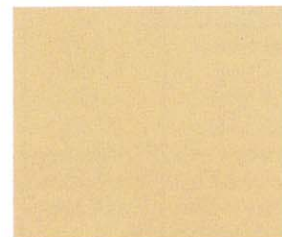

Honey Gold

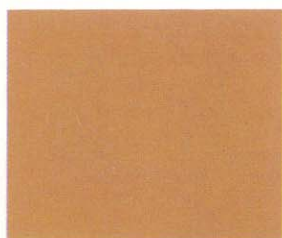

Golden Haze Metallic



Tahitian Gold Metallic



Spinnaker White



Formal Black

*Optional at extra cost.

All product illustrations and specifications are based on authorized information. Although descriptions are believed correct at publication approval, accuracy cannot be guaranteed. Some of the equipment shown on product illustrations is optional, at extra cost. Chrysler Motors Corporation reserves the right to make changes from time to time, without notice or obligation, in prices, specifications, colors and materials, and to change or discontinue models.

Keep your Plymouth coming through in top condition. Service it with men who know it best. See your Plymouth Dealer.



KEEP YOUR
CAR
"FACTORY NEW"
WITH GENUINE
MOPAR PARTS

Plymouth

