

RAM 1500

AUTHENTIC ACCESSORIES



VADA



# HOW TO NAVIGATE



## MENU

Touch/Click the three-line menu icon in the top navigation bar to explore available content destinations, settings, and help



## TO TURN THE PAGES

Touch/Click the arrows on either side of the brochure



## ZOOM

Double-tap/Click to zoom in and out of the brochure



## ALT TEXT

For Alternate Text, please click on the  icon located on each page



*At your service*

## WE ONLY MAKE ORIGINAL PARTS.

MOPAR® IS ORIGINAL EQUIPMENT – DESIGNED BY THE SAME PEOPLE WHO MADE YOUR RAM BRAND VEHICLE.

NO ONE UNDERSTANDS THE ENTIRETY OF YOUR VEHICLE'S FUNCTIONALITY AND DESIGN LIKE WE DO.



### OUR STANDARDS ARE SKY HIGH.

Factory original equipment must adhere to a strict standard of testing. Drive with confidence knowing your Mopar® Parts and Accessories have passed this rigorous testing.



### WE ONLY USE THE GOOD STUFF.

We only use high-quality materials because we know that our parts and accessories will impact the appearance, durability and value of your vehicle for years to come.



### WE HAVE IT. OTHERS DON'T.

Only Mopar has direct, exclusive access to your vehicle's specifications. This information allows us to use an integrated design approach to create precise-fitting parts and accessories.



### WE DON'T DESIGN PARTS OR ACCESSORIES IN A VACUUM.

We consider the vehicle as a whole when engineering our components. Our parts are exclusively designed to complement your vehicle without compromising its aesthetic, functionality and performance.



### EASY-AS-IT-CAN-BE INSTALLATION.

Installing aftermarket pieces often requires cutting/drilling into the vehicle body. Most Mopar Accessories use existing openings and weld nuts for secure installation. This makes the job easier, keeps rust and corrosion away, and helps protect the structural integrity of your Ram Brand vehicle.



ABOVE: RAM 1500 BIG HORN® IN GRANITE CRYSTAL METALLIC FEATURES STAINLESS STEEL TUBULAR SIDE STEPS, CHROME TOW HOOKS, CHROME BODYSIDE MOLDINGS, 20-INCH SATIN CARBON WHEELS AND SOFT TRI-FOLD TONNEAU COVER

ON COVER: RAM 1500 TRX™ IN BILLET SILVER METALLIC/DIAMOND BLACK CRYSTAL PEARL FEATURES OFF-ROAD STYLE RUNNING BOARDS, RAMBAR AND OFF-ROAD 5-INCH LED LIGHT KIT

# CARGO MADE EASY

**A. HARD FOLDING TONNEAU COVER<sup>(1)(2)</sup>** Features an attractive, low-profile design with rigid panels and a high-strength aluminum frame, providing superior security and protection; hidden/quick-release latch system that automatically locks panels when shut – simply lock the tailgate to secure the bed; and an advanced sealing technology for weather resistance. Truck can be driven with cover fully closed, partially closed or fully open, providing full bed access. Made in the U.S.A. [ 82215227AD - 5' 7" Bed ] [ 82215225AD - 5' 7" Bed with RamBox® ] [ 82215224AD - 6' 4" Bed ]

**B. SOFT FOLDING TONNEAU COVER<sup>(1)(2)</sup>** Features a larger opening and softer panels than the Hard Folding Tonneau Cover and uses quick-release latches to make operation and removal fast and easy. Cover is constructed with rails built of durable aluminum material for structural strength and a high-quality canvas that can hold up to extreme weather conditions. [ 82215863AB - 5' 7" Bed ] [ 82215862 - 5' 7" Bed with RamBox ] [ 82215864AB - 6' 4" Bed ] UTILITY RAILS required for use with the 5' 7" RamBox Bed. [ 82215810AB ]

**C. ONE-PIECE TONNEAU COVER IN BODY-COLOR<sup>(1)(2)(3)</sup>** Outstanding protection designed specifically to complement the style of your Ram pickup. Constructed of a lightweight yet super-strong polymer compound with a patented "X-factor" foundation, our One-Piece Tonneau Cover won't weather or crack – unlike comparable fiberglass products. Advantages include a double-seal system, over-rail design, color-match automotive paint finish, integrated interior dome light – and it's all made right here in the U.S.A. See your dealer for a part number specific to your vehicle's specifications.

**D. SOFT ROLL-UP TONNEAU COVER<sup>(2)</sup>** Requiring no special tools or drilling, this top-mount tonneau cover utilizes preset tension controls to keep the cover tight and looking good – year round and even in the harshest of climates. Straight cross tubes ensure a smooth, flat appearance when closed, while side dual-paddle latches securely fasten the cover to the bed. Made in the U.S.A. of quality-constructed, versatile and durable material. [ 82215254AB - 5' 7" Bed ] [ 82215253AB - 5' 7" Bed with RamBox ] [ 82215255AB - 6' 4" Bed ]

Not all part numbers shown. See dealer for additional part numbers by vehicle application.

<sup>(1)</sup> Shown on 5' 7" bed. <sup>(2)</sup> Does not work with Multifunction Tailgate. <sup>(3)</sup> Not compatible with the RamBox® Cargo Management System or the Under-the-Rail Bedliner.





A



B



C

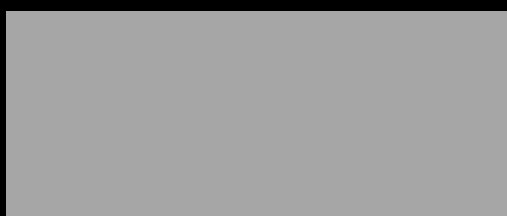

D

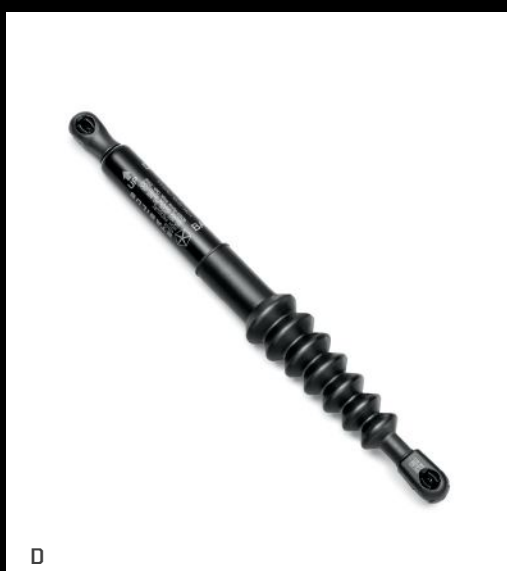

F

**A. BED LIGHT KIT<sup>(1)(2)</sup>** Easily installs into factory-pierced holes on each side of conventional pickup beds to illuminate the cargo area and improve visibility. Includes two lights with integrated on/off switch. [ 82215272AC ]

**B. MOPAR<sup>®</sup> BED ASSIST HANDLE<sup>(3)</sup>** Provides a secure hold when climbing in and out of your truck bed. [ 82215496 ]

**C. POWER RELEASE TAILGATE KIT.** Kit includes two fobs and wiring harness. Part operates tailgate open function only. Compatible TAILGATE DAMPER KIT is available, sold separately. [ 82216123AA ]

**D. TAILGATE DAMPER KIT.** Control the opening rate of your Ram 1500 tailgate with this easy to install Damper Kit. Designed specifically for handling heavy daily use, this kit releases the tailgate at a controlled rate, allowing you to open it even with your hands full. Works with factory cables on trucks without a damper or power release functionality. [ 82215550AB ]

**E. OFF-ROAD 5-INCH LED LIGHT KIT<sup>(4)(5)</sup>** This commercial-grade Light Kit provides an exceptionally bright, fully illuminating light source, needed for safe off-road driving. Light Kit is steam-pressure washer-capable, and also vibration-, shock- and EMC-tested. The cast-aluminum housing ensures proper heat dissipation and long-term durability. Kit contains two off-road 5-inch LED lights, light covers with Mopar<sup>®</sup> logo, wiring harness and switch. [ 82215274AC ] Works with Mopar LIGHT MOUNTING BRACKETS (sold separately). [ 82216127AA - 2 1/4" for Mounting to RamBar ]

**F. CAB PROTECTOR RACK<sup>(6)</sup>** Constructed of industrial-grade steel, providing excellent cab protection from shifting loads in the bed of the truck. Easy, no-drill installation into existing stake hole pockets. [ 82215495AC ] Works with Mopar OFF-ROAD 5-INCH LED LIGHT KIT (sold separately). [ 82215274AC ]

Not all part numbers shown. See dealer for additional part numbers by vehicle application.

<sup>(1)</sup> Properly secure all cargo. <sup>(2)</sup> Not compatible with the Spray-In Bedliner. <sup>(3)</sup> Does not work with the RamBox Cargo Management System. <sup>(4)</sup> Off-Road Lights are aftermarket only, may not be installed by a Chrysler, Dodge, Jeep, Ram or FIAT<sup>™</sup> dealer on any vehicle prior to its first retail sale, and may not be sold or financed in conjunction with the sale of a new vehicle. FCA US LLC does not authorize the installation of these parts on any vehicle prior to its first retail sale. <sup>(5)</sup> Off-Road Lights must remain turned off, or covered, on public roadways. <sup>(6)</sup> Not compatible with the RamBox Cargo Management System or Multifunction Tailgate.



# EXPAND YOUR CAPABILITY

**A. RAMBAR<sup>(1)</sup>** Features a rugged design and mounts securely and easily to your Ram 1500 truck without having to drill any holes. The robust tubular configuration features a powder-coat finish and gives off a sporty vibe. The RamBar also provides an ideal mounting location for the OFF-ROAD 5-INCH LED LIGHT KIT (sold separately). [ 82215959AB ]

**B. MOPAR<sup>®</sup> UNIQUE WHEEL FLARES.** These rugged, heavy-duty Wheel Flares are indispensable if you're off-roading and add style while on the road. Designed as the ultimate defense against debris, branches and gravel. Set of four. [ 82215284AB ]

**C. FORK-MOUNT BIKE CARRIER<sup>(2)(3)</sup>** Carries one bike securely by the front fork and rear wheel. [ TCFKM526AB ]

Not all part numbers shown. See dealer for additional part numbers by vehicle application.

<sup>(1)</sup> Not compatible with the RamBox<sup>®</sup> Cargo Management System or Multifunction Tailgate. <sup>(2)</sup> Properly secure all cargo. <sup>(3)</sup> Mounts to the Sport Utility Bars (sold separately).



RAM 1500 BIG HORN<sup>®</sup> IN BILLET SILVER METALLIC FEATURES RAMBAR, OFF-ROAD 5-INCH LED LIGHT KIT, LIGHT MOUNTING BRACKETS, MOPAR<sup>®</sup> UNIQUE WHEEL FLARES, PICKUP BOX UTILITY RAILS, SPORT UTILITY BARS AND FORK-MOUNT BIKE CARRIER



**A. FORK-MOUNT BIKE CARRIER<sup>(1)(2)</sup>** Carries one bike securely by the front fork and rear wheel. [ TCFKM526AB ]

**B. PICKUP BOX UTILITY RAILS.** These anodized aluminum rails attach to the inside walls of the bed and feature adjustable cleats that slide along the rail system to secure cargo of various sizes. Accommodate the SLIDING TOOLBOXES, SPORT UTILITY BARS and CARGO BED DIVIDER (sold separately). [ 82215285AB - 5' 7" Bed ] [ 82215286AB - 6' 4" Bed ]

**C. SPORT UTILITY BARS<sup>(3)</sup>** Built of heavy-duty Black anodized aluminum, these substantial bars allow for quick carrier installation. Bars attach to the PICKUP BOX UTILITY RAILS (sold separately). [ 82215789 ]

**D. BED-MOUNT CARGO CARRIER<sup>(1)(2)</sup>** Designed to carry cargo safely and securely above your truck bed in conjunction with the CARGO NET (sold separately) and provides two-tier loading capability for added storage. [ TCTRL864 - Basket ] [ 82209422AB - Net ]

**E. UPRIGHT BIKE CARRIER<sup>(1)(2)</sup>** Carries one bike securely. [ TCOE9599 ]

**F. SKI AND SNOWBOARD CARRIER<sup>(1)(2)</sup>** Holds up to six pairs of skis, three snowboards or a combination of the two. [ TCS92725 ]

Not all part numbers shown. See dealer for additional part numbers by vehicle application.

<sup>(1)</sup> Properly secure all cargo. <sup>(2)</sup> Mounts to the Sport Utility Bars (sold separately). <sup>(3)</sup> Not available for vehicles with the RamBox Cargo Management System.





# PUSH BOUNDARIES

**A. BED EXTENDER<sup>(1)</sup>** Extends the bed with the tailgate down. Flipped inward, it's a convenient divider to keep cargo from sliding to the front of the bed. Cannot be used with RamBox<sup>®</sup> Cargo Management System. [ 82215724 ]

Not all part numbers shown. See dealer for additional part numbers by vehicle application.

<sup>(1)</sup> Properly secure all cargo.





A



D



B

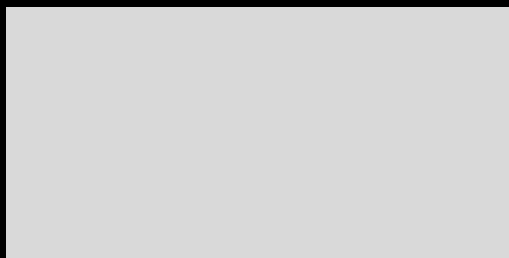

E



C

**SLIDING TOOLBOXES<sup>(1)</sup>** Durable aluminum toolbox with easy-access lid, protective seal coat, stainless steel hinges, locking handle and continuous body welds. Available for conventional or RamBox® Cargo Management System beds equipped with PICKUP BOX UTILITY RAILS (sold separately).

**A. CONVENTIONAL BED SLIDING TOOLBOX.**

[ 82211356AB ]

**B. RAMBOX® BED SLIDING TOOLBOX.**

[ 82211357 ]

**C. CARGO BED DIVIDER<sup>(2)</sup>** Easily adjustable divider is constructed of strong aluminum tubing and is designed for trucks equipped with PICKUP BOX UTILITY RAILS (sold separately). Divider fits snugly into the slots located along the utility rails, enabling you to secure cargo of various sizes. Cannot be used with RamBox Cargo Management System or the Multifunction Tailgate.

[ 82215481 ]

**D. RAMBOX CARGO DIVIDERS.** Set of three vertical dividers fit in the RamBox side slots to keep it all organized. Durable, stylish and easy to install/remove. [ 82215793AB ]

**E. BED MAT<sup>(3)(4)</sup>** Protects and preserves your truck's bed floor and tailgate from dents and scratches. Nylon-reinforced rubber mat removes easily for cleaning.

[ 82215784AB - 5' 7" Bed with RamBox® ]

[ 82215785AB - 6' 4" Bed ]

**F. DROP-IN BEDLINER<sup>(3)</sup>** Skid-resistant bedliner's ribbed construction helps keep cargo from shifting, promotes water drainage from bed and includes built-in supports to split cargo. The liner is molded of a high-density polyethylene blend for added durability. Tailgate liner included.

**G. SPRAY-IN BEDLINER<sup>(3)</sup>** Super tough and installed right at the factory. Available exclusively at the time of vehicle order.

[ Sales Code: XMF ]

Not all part numbers shown. See dealer for additional part numbers by vehicle application.

<sup>(1)</sup> Shown on 5' 7" bed. <sup>(2)</sup> Not compatible with the Multifunction Tailgate.

<sup>(3)</sup> Properly secure all cargo. <sup>(4)</sup> Not compatible with the Multifunction Tailgate.



F



G



# NO REST IN THIS BED

THE CARGO BED IS THE HEART AND SOUL OF RAM 1500 CAPABILITY. THE AUTHENTIC ACCESSORIES SHOWN HERE DRAMATICALLY RAMP UP STORAGE AND DURABILITY.

**A. TRUCK BED STORAGE SYSTEM:<sup>(1)</sup>** Organize your cargo with this smart, ergonomic and U.S.A.-made toolbox. System includes two weatherproof, waist-height lockable drawers (rated at 200 lb each) that slide out to store just about everything. On top, the heavy-duty cover accommodates a true 2,000-lb payload, maintaining full use of the bed area. [ 82215517AC - 5' 7" Bed ]  
[ 82215518AC - 6' 4" Bed ]

Not all part numbers shown. See dealer for additional part numbers by vehicle application.

<sup>(1)</sup> Not compatible with the RamBox Cargo Management System or the Under-the-Rail Bedliner.

Properly secure all cargo.





A



B, C

**A. HITCH RECEIVER<sup>(1)</sup>** This Class IV Hitch Receiver has a 12,750-lb towing capacity with 1,275-lb tongue weight capacity. No rear bumper or fascia trimming or cutting required when installing. This hitch is the same as the production hitch. [ 82215222AC ]

**B. BALL MOUNT ADAPTER KIT<sup>(1)</sup>** Choose the drop weight that's right for your application. Fits 2-inch receivers. Made of heavy-duty cold-rolled steel with e-coat primer and powder-coat paint for extreme durability. [ 82213547 - 2" Drop ] [ 82213548 - 4" Drop ] [ 82213640 - 6" Drop ]

**C. TRAILER-TOW BALL KIT<sup>(1)</sup>**  
[ 82213563 - Chrome 1 7/8" Ball with 1" Shank ]  
[ 82213565 - Chrome 2" Ball with 1" Shank ]

**D. TELESWIVEL<sup>®</sup> HITCH RECEIVER<sup>(1)</sup>**  
Easily and quickly attaches your trailer by extending and swiveling the trailer ball – and at an operating angle 25% larger than that of conventional hitches. Available in Standard, Drop Hitch and Adapter Accessory Channel versions. Adapters sold separately (2-INCH BALL-PINTLE or 2-INCH and 2 5/8-INCH DUAL BALL options). [ 82215194 ]

**E. TELESWIVEL DROP HITCH<sup>(1)</sup>** Allows for height adjustments within an 11-inch range (4-inch rise and 7-inch drop) to accommodate trailers of varying heights. [ 82215196 ]

**F. TELESWIVEL ADAPTER ACCESSORY CHANNEL<sup>(1)</sup>** Allows for installation of various trailering accessories. [ 82215195 ]

**G. 2-INCH BALL-PINTLE.** [ 82215198 ]

**H. 2 5/8-INCH DUAL BALL.** [ 82215197 ]

Not all part numbers shown. See dealer for additional part numbers by vehicle application.

<sup>(1)</sup> Check User Guide for hitch type, load capacity and heavy-duty equipment required. Do not exceed rated tow capacity of the vehicle as equipped. Trailer may require items not supplied by Mopar.



D

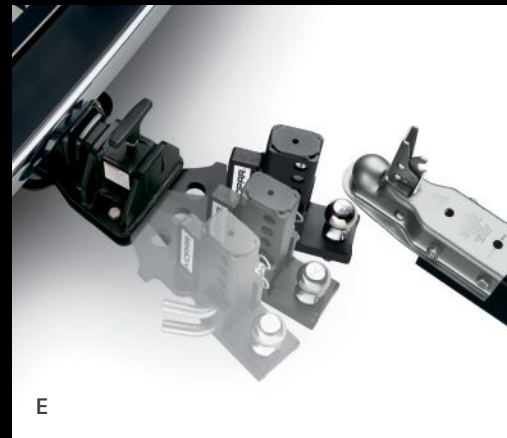

E



F, G



F, H



**HITCH RECEIVER COVER<sup>(1)</sup>** Protects vehicle's hitch opening from the elements and includes a retention strap.

**A. RAM'S HEAD LOGO. [ 82216302AA ]**

**B. MOPAR<sup>®</sup> LOGO. [ 82208455AB ]**

**TOW HOOKS<sup>(2)</sup>** Constructed of industrial-grade steel and can handle up to 1.5x the Gross Vehicle Weight Rating. Available in Chrome and Black finishes giving your Ram truck a sporty, off-road look.

**C. CHROME. [ 82215269 ]**

**D. BLACK. [ 82215268AB ]**

**E. TRAILER-TOW MIRRORS.** These dual-function aerodynamic mirrors install quickly and help improve rear visibility when towing trailers or campers. Featuring one mirror paired with a minor wide-view mirror, the huge 7x11-inch design operates vertically when trawling and flips to horizontal for everyday driving convenience. [ 82215276AD ]

Not all part numbers shown. See dealer for additional part numbers by vehicle application.

<sup>(1)</sup> Check User Guide for hitch type, load capacity and heavy-duty equipment required. Do not exceed rated tow capacity of the vehicle as equipped. Trailer may require items not supplied by Mopar. <sup>(2)</sup> Mopar Performance Parts are sold "as is" unless otherwise noted.



# STEP UP TO CONVENIENCE

**A. BED STEP.** This retractable step provides a convenient intermediate platform to access the truck bed. A spring-loaded cam allows the step to be easily extended by stepping down on it and retracts with a slight push to stow out of the way. [ 82215289AH ]

**B. CHROME BODYSIDE MOLDINGS.** Enhance the appearance of your vehicle. No cutting or drilling required. Easily install in minutes. [ 82215280 - Crew Cab / 5' 7" Bed ] [ 82215697 - Quad Cab® / 6' 4" Bed ] [ 82215698 - Crew Cab / 6' 4" Bed ]

**C. WHEEL-TO-WHEEL LENGTH STAINLESS STEEL TUBULAR SIDE STEPS.** These polished stainless steel steps combine the classic tubular design with slip-resistant step pads on each side for sure footing. No drilling required. Available in cab length or wheel-to-wheel length. [ 82215299AB - Quad Cab / 6' 4" Bed ] [ 82215300AB - Crew Cab / 5' 7" Bed ] [ 82215305AB - Crew Cab / 6' 4" Bed ]

Not all part numbers shown. See dealer for additional part numbers by vehicle application.



RAM 1500 BIG HORN® IN DELMONICO RED PEARL FEATURES BED STEP, CHROME BODYSIDE MOLDINGS, STAINLESS STEEL TUBULAR SIDE STEPS AND 20-INCH SATIN CARBON WHEELS

Properly secure all cargo.





**A. CAB LENGTH STAINLESS STEEL TUBULAR SIDE STEPS.** These polished stainless steel steps combine the classic tubular design with slip-resistant step pads on each side for sure footing. No drilling required. Available in cab length or wheel-to-wheel length. [ 82215308AB - Quad Cab ] [ 82215291AB - Crew Cab ]

**B. POWERED RUNNING BOARDS.** These automatic, electric-powered running boards instantly extend when you open your door and then hide safely out of sight when the doors close. Count on improved ground clearance, enhanced aerodynamics and head-turning good looks. [ 82215288AD - Quad Cab® ] [ 82215287AD - Crew Cab ]

**RUNNING BOARDS.** Designed for minimal slippage and maximum looks, these running boards won't rust and are custom-designed to the unique forms that distinguish your Ram truck.

**C. MATTE BLACK-PAINTED CAB LENGTH.** [ 82215294AB - Quad Cab ] [ 82215301AB - Crew Cab ]  
**D. GLOSS BLACK-PAINTED CAB LENGTH.** [ 82215510AB - Quad Cab ] [ 82215512AB - Crew Cab ]

**E. OFF-ROAD STYLE RUNNING BOARDS.** Cast-aluminum construction with a rugged texture cover providing anti-slip functionality and an off-road look. Designed to fit close to the vehicle for improved clearance with no drilling and easy installation. [ 82215514AC - Quad Cab ] [ 82215508AC - Crew Cab ]

**F. MULTIFUNCTION TAILGATE BED STEP.** This retractable step provides a convenient intermediate platform to access the truck bed. A spring-loaded cam allows the step to be easily extended by stepping down on it and retracts with a slight push to stow out of the way. Bed Step is made of high strength aluminum with an e-coat finish to help protect against rust and corrosion. Mounts to the vehicle frame for secure attachment with no-drill installation and load-rated up to 350 lb. [ 82216265AB ]

Not all part numbers shown. See dealer for additional part numbers by vehicle application.



F

# PROTECT IT, WITH STYLE

FROM FRONT TO REAR AND INSIDE AND OUT, MOPAR® HAS WHAT IT TAKES TO KEEP YOUR RAM 1500 LOOKING GOOD.

**FRONT AIR DEFLECTOR.** Deflects road debris, dirt and insects away from vehicle's hood and windshield.

**A. CHROME.** [ 82215475 ]

**B. MATTE BLACK.** [ 82215476 ]

**C. SIDE WINDOW AIR DEFLECTORS.** Acrylic-tinted deflectors follow the contours of the windows and allow them to be partially open, even during inclement weather.

[ 82215478 - Crew Cab ] [ 82215477 - Quad Cab® ]

**D. CARGO BIN LOCKS.** Designed for Crew Cab in-floor storage bins, these stainless steel locks install easily to create a secure compartment for storing valuables. [ 82211653 ]

Not all part numbers shown. See dealer for additional part numbers by vehicle application.







A



B



C



D



E



F

**A. LOCKING CONSOLE.** Converts your production console into a heavy-duty lockable storage area for valuables. The insert allows full use of armrest and lid and comes ready to install with no drilling required. [ 82215519AC ]

**B. DIESEL GAS CAP.** Helps keep the fuel area clean with an easy on/off ergonomic design. [ 82215782 ]

**C. COLD WEATHER GRILLE COVER KIT.** For diesel engines only. Cover helps to warm both the cabin and engine in cold weather. Specially designed with flaps that open/close to prevent snow and ice buildup – which eases their removal when necessary. [ 82215460AC - Tradesman® / Big Horn® ] [ 82216062AB - Rebel® ] [ 82216061AB - Laramie® / Limited ]

**SPLASH GUARDS.<sup>(1)</sup>** Designed exclusively for the Ram 1500, these guards help protect the lower bodyside panels from damage caused by gravel, salt and road debris. Available for Ram 1500 models (with and without wheel flares).

**D. FRONT.**  
[ 82215488AC - with Fender Flares ]  
[ 82215487AC - without Fender Flares ]

**E. REAR.**  
[ 82215489AD - with Fender Flares ]  
[ 82215490AD - without Fender Flares ]

**HEAVY-DUTY RUBBER SPLASH GUARDS.**

**FRONT.** (Not shown).  
[ 82216217AA - with Fender Flares ]  
[ 82216215AA - without Fender Flares ]

**F. REAR.**  
[ 82216216AA - with Fender Flares ]  
[ 82216218AA - without Fender Flares ]

Not all part numbers shown. See dealer for additional part numbers by vehicle application.

<sup>(1)</sup> Not available for Dual-Rear-Wheel models.

**VADA**

WE'VE GOT YOU COVERED





A



D



B



E



C



F



G



H

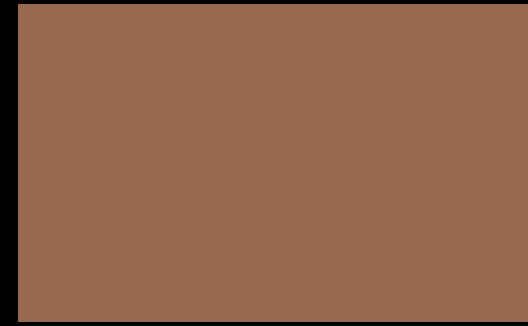

I

**ALL-WEATHER FLOOR MATS.** These custom, bucket-style mats offer maximum coverage and provide deeper channels to trap and protect your floor from wetness, salt, mud, dirt and grime. Available in Black or Brown.

**A. BLACK.**

[ 82215323AD - Quad Cab® ] [ 82215321AD - Crew Cab ]

**B. BROWN.**

[ 82215322AD - Quad Cab ] [ 82215320AD - Crew Cab ]

**C. BLACK WITH RED RAM'S HEAD LOGO.**

[ 82216269AB - Crew Cab ]

**D. BLACK WITH RED RAM'S HEAD LOGO.**

[ 82216268AB - Quad Cab ]

**E. BLACK WITH GRAY RAM'S HEAD LOGO.**

[ 82215422AD - Crew Cab ]

**F. BLACK WITH GRAY RAM'S HEAD LOGO.**

[ 82215421AD - Quad Cab ]

**PREMIUM CARPET FLOOR MATS.** Protect vehicle's footwell carpet. Mats feature the Ram's Head logo. Available in Black or Brown. Front and rear mats sold separately.

**G. FRONT.**

[ 82215405 - Black ] [ 82215407 - Brown ]

**H. QUAD CAB® REAR.**

[ 82215411 - Black ] [ 82215410 - Brown ]

**I. CREW CAB, REAR.**

[ 82215409 - Black ] [ 82215412 - Brown ]

Not all part numbers shown. See dealer for additional part numbers by vehicle application.



# INSIDE IS WHERE IT'S AT

**A. TRAILER CAMERA KIT<sup>(1)</sup>** Improves your rearview visibility to help maneuver around obstacles with your trailer. Trailer Camera Kit is designed to be used in conjunction with the vehicle Trailer Camera Wiring Prep Kit (sold separately). Kit includes one wired camera with housing, trailer wiring harnesses, one 12-way plug, one 12-way park connector and mounting hardware. Note that the Trailer Camera Kit has dual camera capability but requires purchase of two kits. [ 82216068AD ]

**B. TRAILER CAMERA WIRING PREP KIT.** For vehicles without factory camera wiring harness, this Prep Kit allows for the installation of the Trailer Camera Kit (listed above, sold separately). [ 82216274AB ]

**C. MEDIA SCREEN PROTECTOR.** Made of tough, clear, static-cling film. This anti-glare and scratch-resistant protector also provides increased clarity. It does not affect the accuracy of the touchscreen and is removable with no damage to the media center screen. [ 82216076AA ]

**D. WIRELESS CHARGING PAD.** Charging made quick and easy and without use of wires when compatible phone is placed within charging surface of the pad. Professional installation recommended. Not compatible with all center consoles. [ 82215150AF ]

Not all part numbers shown. See dealer for additional part numbers by vehicle application.

<sup>(1)</sup> Always check entire surroundings visually before proceeding.





A



C



B

**A. SEAT COVERS.** Tailored for a perfect fit, these fabric covers won't block seat controls while protecting original upholstery from dirt and damage. Easily removable for washing and feature the Ram's Head logo. [ 82215462 - Front Bench ]  
[ 82215463 - Front Bucket ]  
[ 82215472 - Rear Bench Quad Cab® ]  
[ 82215474 - Rear Bench Crew Cab ]

**B. DOOR SILL GUARDS.** Additional protection against scratches and scuffs. They feature a laser-etched Ram logo on front-door guards. Available in three finishes.

**LIGHT FROST.** (Shown).

[ 82215705AB - Quad Cab ] [ 82215703AB - Crew Cab ]

**BLACK.** (Not shown).

[ 82215420AB - Quad Cab ] [ 82215419AB - Crew Cab ]

**MOUNTAIN BROWN.** (Not shown).

[ 82215706AB - Quad Cab ] [ 82215704AB - Crew Cab ]

**C. KATZKIN® LEATHER INTERIORS.** Handcrafted and professionally designed leather-trimmed interior options. Shown in Black featuring the Ram's Head logo, with Maraschino contrast stitching and perforated leather center panels. Ask your dealer for more information.

Not all part numbers shown. See dealer for additional part numbers by vehicle application.

<sup>(1)</sup> Check state and local laws on the use of remote starters.



## REMOTE START<sup>(1)</sup>

Hit the ground running with the ability to start your vehicle from a distance with the touch of a button. The system operates seamlessly with your vehicle's factory electronic security system.

[ 82216122AB ]

# THE LOOK YOU WANT, FROM HOOD TO WHEELS

**MOPAR® VINYL GRAPHICS.** It's all about adding character and personality – and these bodyside and hood graphics do it. Mopar® Graphics are designed to enhance the curves and lines of your Ram 1500 and tested to withstand all the elements. Professional installation recommended.

Hood graphic works in conjunction with the standard hood.

**A. GRAY METALLIC BODYSIDE GRAPHIC.**

[ 82215529AB - Quad Cab® / 6' 4" Bed ]

[ 82215532AB - Crew Cab / 5' 7" Bed ]

[ 82215815AB - Crew Cab / 6' 4" Bed ]

**B. BLACK BODYSIDE GRAPHIC.**

[ 82215531AB - Quad Cab / 6' 4" Bed ]

[ 82215530AB - Crew Cab / 5' 7" Bed ]

[ 82215816AB - Crew Cab / 6' 4" Bed ]

**C. BLACK HOOD GRAPHIC, SPORT HOOD.** [ 82215534AB ]

**D. LICENSE PLATE FRAME KIT.** Stainless steel in Satin Black with Mopar logo valve stem caps and logo key chain. [ 82215850 ]

Not all part numbers shown. See dealer for additional part numbers by vehicle application.



A



C



B



D



A

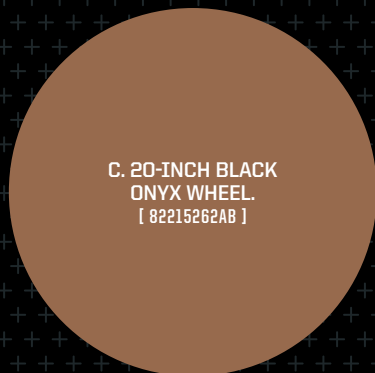

C. 20-INCH BLACK  
ONYX WHEEL.  
[ 82215262AB ]



D

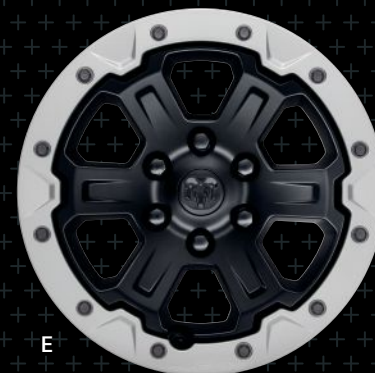

E



A. 20-INCH AGGRESSIVE  
STYLE WHEEL. [ 82215260AB ]

B. 20-INCH LUXURY  
WHEEL. [ 82215261AB ]



C

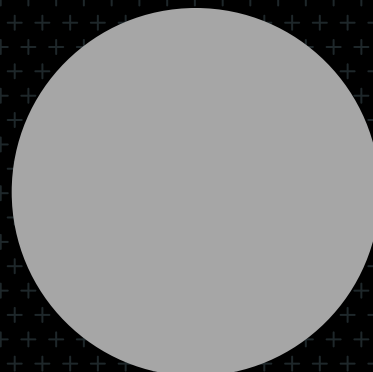

F



B

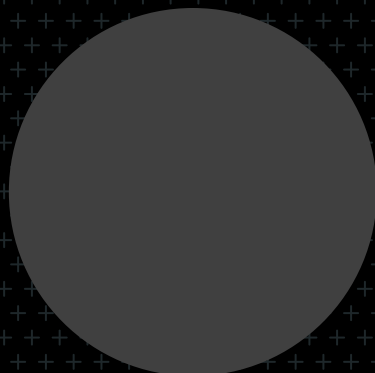

D. 20-INCH SATIN  
CARBON WHEEL.  
[ 82215263AB ]

E. 18-INCH BEADLOCK-  
CAPABLE WHEEL. 19-mm  
offset allows for larger tires.  
Includes Trim Ring.  
[ 82215259AB ]

F. FUNCTIONAL BEADLOCK  
RING KIT. Shown on 18-inch  
Beadlock-Capable Wheel.  
[ P5160110 ]

# THE ALL-NEW RAM TRX™

**A. OFF-ROAD 5-INCH LED LIGHT KIT.** This commercial-grade Light Kit provides an exceptionally bright, fully illuminating light source, needed for safe off-road driving. Light Kit is water-submersible, steam-pressure washer-capable and is also vibration-, shock- and EMC-tested. The cast-aluminum housing ensures proper heat dissipation and long-term durability. Kit contains two 5-inch LED lights, light covers with Mopar® logo, wiring harness and switch. [ 82215274AC ] Works with Mopar LIGHT MOUNTING BRACKETS (sold separately). [ 82216127AA - 2 ¼" for Mounting to RamBar ]

**B. RAMBAR.** Features a rugged design and mounts securely and easily to your Ram 1500 truck without having to drill any holes. The robust tubular configuration features a powder-coat finish and gives off a sporty vibe. The RamBar also provides an ideal mounting location for the OFF-ROAD 5-INCH LED LIGHT KIT (sold separately). [ 82215959AB ]

**C. BED-MOUNTED SPARE TIRE CARRIER KIT.**<sup>(1)</sup> Although this carrier is purposefully designed to be fully integrated to the vehicle and securely holds up to a 37-inch tire, it can also be easily removed when use of the full truck bed is needed. Manufactured for durability, the carrier boasts high-grade thick gauge steel, high-strength welded tubular construction and finished with a base layer of corrosion protection. It's then painted with e-coat and completed with a decorative, high-quality Black powder top coat. Kit includes all mounting hardware, mounting brackets, wheel lug nuts and detailed installation instructions. Available for vehicles without Spray-In Bedliner. [ 82216108AA ]

**D. FUNCTIONAL BEADLOCK RING KIT.**<sup>(2)</sup> Shown on production 18-inch Beadlock-Capable Wheel. Constructed of tough forged aluminum with Black finish. The ring clamps the outer tire bead to the rim, enabling maximum traction with lower tire pressures, ideal engineering for off-roading. [ P5160250AA ]

**E. OFF-ROAD STYLE RUNNING BOARDS.** Cast-aluminum construction with a rugged texture cover providing anti-slip functionality and an off-road look. Designed to fit close to the vehicle for improved clearance with no drilling and easy installation. [ 82215514AC - Quad Cab® ] [ 82215508AC - Crew Cab ]

Not all part numbers shown. See dealer for additional part numbers by vehicle application.

<sup>(1)</sup> Not compatible with the Spray-In Bedliner. <sup>(2)</sup> Mopar Performance Parts are sold "as is" unless otherwise noted.



RAM 1500 TRX™ IN BILLET SILVER METALLIC/DIAMOND BLACK CRYSTAL PEARL FEATURES OFF-ROAD 5-INCH LED LIGHT KIT, LIGHT MOUNTING BRACKETS, RAMBAR, BED-MOUNTED SPARE TIRE CARRIER KIT, FUNCTIONAL BEADLOCK RING KIT AND OFF-ROAD STYLE RUNNING BOARDS





# THE ALL-NEW RAM TRX™

**A. OFF-ROAD STYLE RUNNING BOARDS.** Cast-aluminum construction with a rugged texture cover providing anti-slip functionality and an off-road look. Designed to fit close to the vehicle for improved clearance with no drilling and easy installation. [ 82215514AC - Quad Cab® ] [ 82215508AC - Crew Cab ]

**B. ROCK RAILS.** Help absorb impact and protect lower bodyside panels both on-road and off-road. Their stylish and functional design is engineered to meet stringent loading and durability. Constructed of aluminum and attach to the vehicle using high-strength steel brackets. The Black powder-coat texture seamlessly blends with vehicle aesthetics, allowing for an easy ingress/egress through the integrated step pad. Available for all Ram 1500 Crew Cab models. [ 82216078AB ]

**C. TRX™ BED STEP.** Load-rated for up to 350 lb, the Bed Step features an articulating arm that lowers for easy access to the truck bed and retracts to a stored position with a gentle push, giving an out-of-the-way look within the bumper. Applicable only to Ram 1500 TRX™ vehicles. [ 82216278AC ]

**D. BLACK CREW CAB ALL-WEATHER FLOOR MATS.** These custom, bucket-style mats offer maximum coverage and provide deeper channels to trap and protect your floor from wetness, salt, mud, dirt and grime. [ 82216412AA ]

Not all part numbers shown. See dealer for additional part numbers by vehicle application.



# FINE-TUNE AND FORTIFY

**A. SKID PLATES.** Heavy-gauge steel painted with a high-quality Black powder-coat finish, offering vital protection of the underbody. [ 82215267AB - Transfer Case ] [ 82215265AB - Front Suspension ]

**B. CAT-BACK EXHAUST<sup>(1)</sup>** Helps increase horsepower and torque of 5.7L engines and delivers a deep exhaust tone. Constructed with AL409 stainless steel mandrel-bent tubing and is compatible with production and Mopar® EXHAUST TIPS. [ 77072520AA ]

**C. COLD AIR INTAKE<sup>(1)(2)</sup>** Increases the airflow into the intake manifold to boost horsepower and torque under varying atmospheric conditions. Easy to install. [ 77072428AB ]

**D. 2-INCH LIFT KIT WITH FOX® SHOCKS<sup>(3)</sup>** The Mopar 2-inch Lift Kit is designed and engineered to improve ground clearance and appearance for your Ram 1500 vehicle. The kit features FOX® 2.0 Performance Series IFP shocks. Its brushed aluminum shock body dissipates heat faster than conventional steel and combines with other race-inspired technology to provide incredible fade-free performance, precise handling and stability. Kit includes front shocks, front upper control arms, rear shocks, spring spacers, jounce spacers and a rear track bar bracket. These parts are easy to install as no driveshaft or brake line replacements are required. The kit also works with Electronic Stability Control (ESC)<sup>(4)</sup> and new alignment specifications, which are included in the instructions, and is available for select 2018 - 2021 Ram 1500 4x4 vehicles with standard height steel springs. [ 77072424AC ]

Not all part numbers shown. See dealer for additional part numbers by vehicle application.

<sup>(1)</sup> Mopar Performance Parts are sold "as is" unless otherwise noted. <sup>(2)</sup> This part is designed and intended solely for use in competition vehicles driven on tracks or off-road. Vehicles equipped with this part should not be driven on public roads or highways. Mopar customers are responsible for ensuring that their use of their vehicle equipped with this part complies with applicable federal, state/provincial, and local laws, regulations and ordinances. Vehicles equipped with this part and driven on public roads or highways may violate U.S., California, Canadian or local motor vehicle emissions laws and regulations.

<sup>(3)</sup> Mopar Performance Parts, including Lift Kits, are designated as "Off-Road Only" parts and have not been evaluated or tested for crashworthiness or compliance with safety standards. Mopar Performance Parts noted as "Off-Road Only" are aftermarket only, may not be installed by a Chrysler, Dodge, Jeep®, Ram or FIAT® dealer on a new vehicle, and may not be sold or financed in conjunction with the sale of a new vehicle. FCA US LLC does not authorize the installation of any part noted as "Off-Road Only" on any vehicle prior to its first retail sale. <sup>(4)</sup> Always drive carefully, consistent with conditions. Always wear your seat belt and obey traffic laws.



A



C



B



D

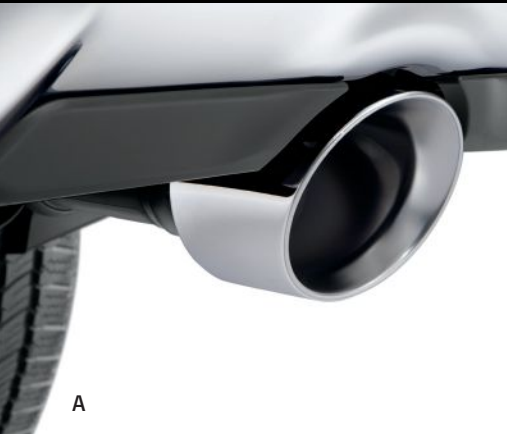

**EXHAUST TIPS.** These 5-inch, dual-wall Exhaust Tips will enhance your existing system, giving your Ram pickup a sporty, finished appearance. Sold as a set of two.  
**A. POLISHED.** [ 82216080AA ]  
**B. BLACK.** [ 82216079AA ]

**C. LED FOG LIGHT KIT.<sup>(1)</sup>** Allows you to upgrade your halogen fog lights to production LED lights. Kit includes LED lights, bezels, mounting hardware and wire harness. [ 82215273AC ]

**D. SPARE TIRE LOCK.** [ 82216081AA ]

**E. WHEEL LOCKS.** Include four chrome-plated lug nuts and a special-fitting key. [ 82212564 ]

Not all part numbers shown. See dealer for additional part numbers by vehicle application.

<sup>(1)</sup> Check local laws on installation and use.



**VADA**

# NO ONE BUT MOPAR®

WHEN YOU DRIVE A RAM BRAND VEHICLE, YOU'RE NOT JUST PART OF THEIR FAMILY, YOU'RE A PART OF OURS – THE MOPAR® FAMILY. IN OUR FAMILY, WE TAKE CARE OF EACH OTHER. WE BELIEVE SERVICE ISN'T JUST ABOUT TUNE-UPS AND PARTS, IT'S ABOUT COMPLETE CUSTOMER CARE.

HERE IS HOW WE TAKE YOUR OWNERSHIP EXPERIENCE TO THE NEXT LEVEL.



SHOW YOUR BRAND PRIDE.

## OFFICIAL MERCHANDISE

You'll find everything from apparel to lifestyle pieces and specialty goods, all handpicked and of the highest quality! Sign up to receive special offers and updates.

[www.wearmopar.com](http://www.wearmopar.com)



AT YOUR FINGERTIPS.

## MOPAR® OWNER'S SITE & COMPANION APP

Get all of the resources you need to make owning your Chrysler, Jeep®, Dodge, Ram or FIAT® Brand vehicle the best experience possible. Schedule service directly with your preferred dealer, create a custom online dashboard tailored to you and your vehicle, and access personalized resources, including your Owner's Manual, Vehicle Health Report, special offers and more – anytime, anywhere. Register your vehicle at [mopar.com](http://mopar.com) or download the Mopar® Owner's Companion App today.

[www.mopar.com/en-us/sign-in](http://www.mopar.com/en-us/sign-in)



CONNECT COMPLETELY.

## VEHICLE HEALTH REPORT

If your vehicle is equipped with Uconnect® you can receive an online monthly Vehicle Health Report with an active subscription. The easy-to-follow, color-coded alerts and health status summary – delivered right to your email or available on demand – can help keep your vehicle running at its best. Learn more and activate today.

[www.mopar.com/en-us/my-vehicle/vehicle-health-report/details](http://www.mopar.com/en-us/my-vehicle/vehicle-health-report/details)



TRUST THE EXPERTS.

## MOPAR® EXPRESS LANE SERVICE

We're here to help you properly maintain and care for your vehicle. Our certified technicians are trained to know your vehicle best, and our Mopar® Express Lane service departments are set up to get you in, out and back on the road again. For expert service and more, always be sure to choose Mopar.

[www.mopar.com/en-us/services/express-lane](http://www.mopar.com/en-us/services/express-lane)



WE BUILT IT. WE BACK IT.

## MOPAR® VEHICLE PROTECTION PLANS

A variety of Protection Plans accepted at all FCA US dealerships have been designed to meet the needs of your unique lifestyle on the road. We stand behind every extended protection plan with certified, factory-trained technicians and the use of original equipment parts. Ask for a Mopar® Vehicle Protection Plan at your dealership, call (800) 442-2666 or visit [mopar.com](http://mopar.com)

[www.mopar.com/en-us/care/mopar-vehicle-protection](http://www.mopar.com/en-us/care/mopar-vehicle-protection)





owners.ramtrucks.com | ramtrucks.com | mopar.com | moparvehicleprotection.com



INSTAGRAM



[www.instagram.com/officialmopar](http://www.instagram.com/officialmopar)



#Mopar | #ThisIsMopar | #MoparFam  
#MoparOrNoCar | #MoparNation



@OfficialMopar



FACEBOOK



[www.facebook.com/mopar](http://www.facebook.com/mopar)



TWITTER



[www.twitter.com/officialmopar](http://www.twitter.com/officialmopar)



#Mopar | #ThisIsMopar



@OfficialMopar



YOUTUBE



[www.youtube.com/mopar](http://www.youtube.com/mopar)

©2021 FCA US LLC. All Rights Reserved. Chrysler, Dodge, Jeep, Ram, Mopar, the Ram's Head logo, Big Horn, Laramie, Mopar Vehicle Protection, Quad Cab, RamBox, Rebel, Tradesman and Uconnect are registered trademarks and TRX is a trademark of FCA US LLC. FIAT is a registered trademark of FCA Group Marketing S.p.A., used under license by FCA US LLC.

Facebook and logo are registered trademarks of Facebook, Inc. FOX is a registered trademark of Fox Factory, Inc. Instagram and logo are registered trademarks of Instagram, Inc. Katzkin and the Katzkin logo are registered trademarks of Katzkin Leather Interiors, Inc. TeleSwivel is a registered trademark of TeleSwivel, LLC. The Twitter logo is a service mark of Twitter, Inc. The YouTube logo is a registered trademark of Google LLC. All other trademarks are the property of their respective owners.

Since the time of printing, some of the information you'll find in this catalog may have been updated. The appearance of accessories shown may vary depending on vehicle application. Visit your Ram dealer for the latest Mopar product information. Visit the Mopar website at [mopar.com](http://mopar.com)

Catalog #00PM5137 (Quantity of 25) 03/21 10K

