

Chrysler '61 Ch

Chrysler '61 Chry

Chrysler '61 C

Chrysler '61 Chry

LAWSON OATES ON BROADWAY  
TELEPHONE REGENT 6-5521



Featuring the new Windsor—a full-size Chrysler—Built to Command

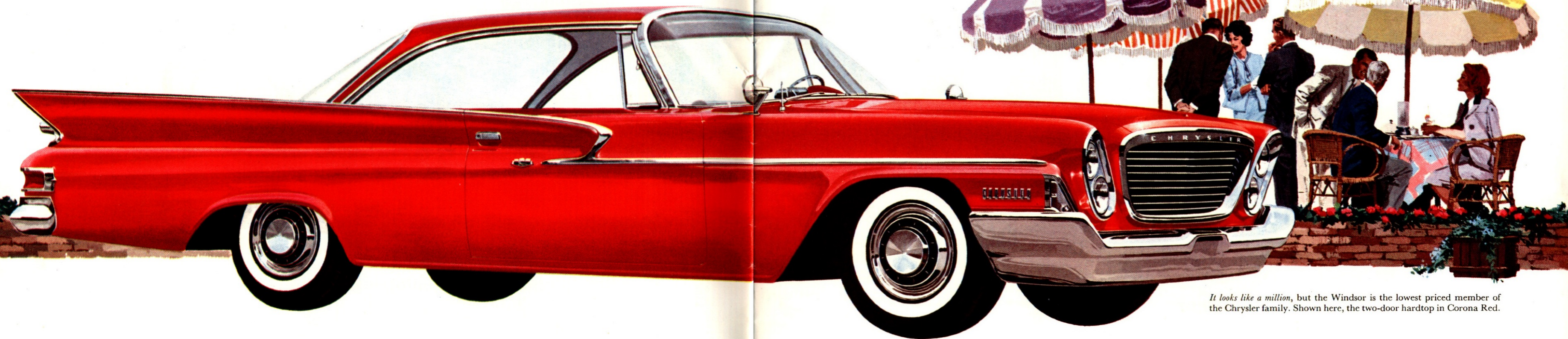

*It looks like a million, but the Windsor is the lowest priced member of the Chrysler family. Shown here, the two-door hardtop in Corona Red.*

This is Chrysler for '61 the "prestige" car built to take unchallenged command of the road. It comes in three series and thirteen models. There are no junior editions. Every Chrysler is a full-size, grown-up car with real six-people room. Every Chrysler is a richly furnished comfortable car fitted with deep-nap broadcloth, textured nylons or supple vinyls. Every Chrysler is a powerful, yet economical car with a V-8 designed by engineers who have produced class winners in three of the last four Mobilgas Economy Runs. And every Chrysler—Windsor . . . Saratoga . . . New Yorker is built the same solid way. Body and frame are joined in a strong, one-piece Unibody. The Unibody is immersed in six different chemicals and rinses to fight rust inside and out. Ninety-five pounds of sound deadener sop up annoying noise. And Chrysler's Torsion-bar suspension grips the road with such assurance that even seasoned auto experts sit up and take notice.

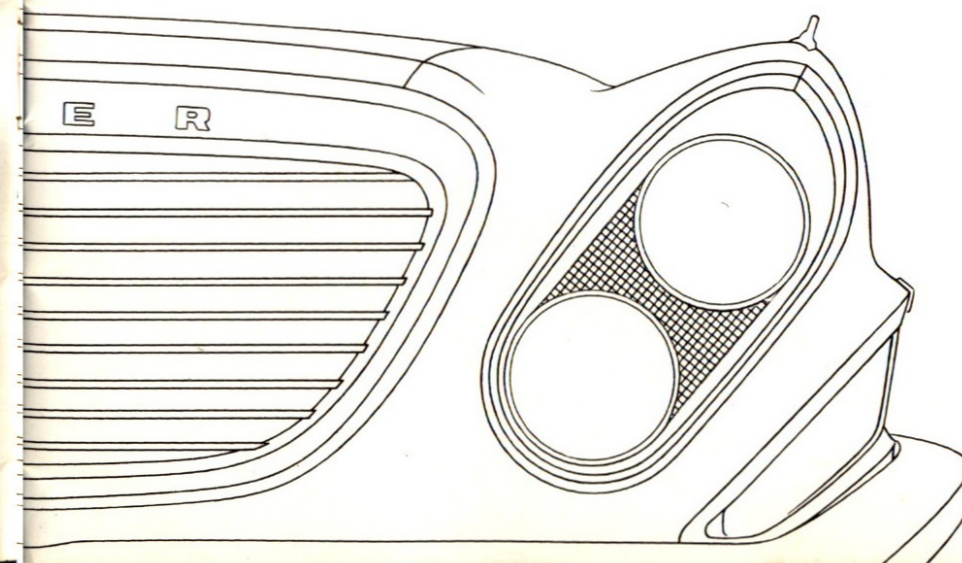

## The Chrysler Windsor

Like your cars roomy? Rangy? Rugged? Like big cars (but hate big price tags)? Then the Chrysler Windsor is your kind of car. Compact? You bet it isn't. The new Chrysler Windsor is a full-size stretching 122 comfortable inches hub to hub. It's a full-powered car packing a lively 361 cubic-inch V-8 engine that's tuned to run on regular gasoline. It's a complete new car built to Chrysler standards of quality. Don't be afraid to ask "how much"?



City smart, country strong, the new Newport Town & Country wagon is at home anywhere. This one's Capri Blue. How would you like yours?

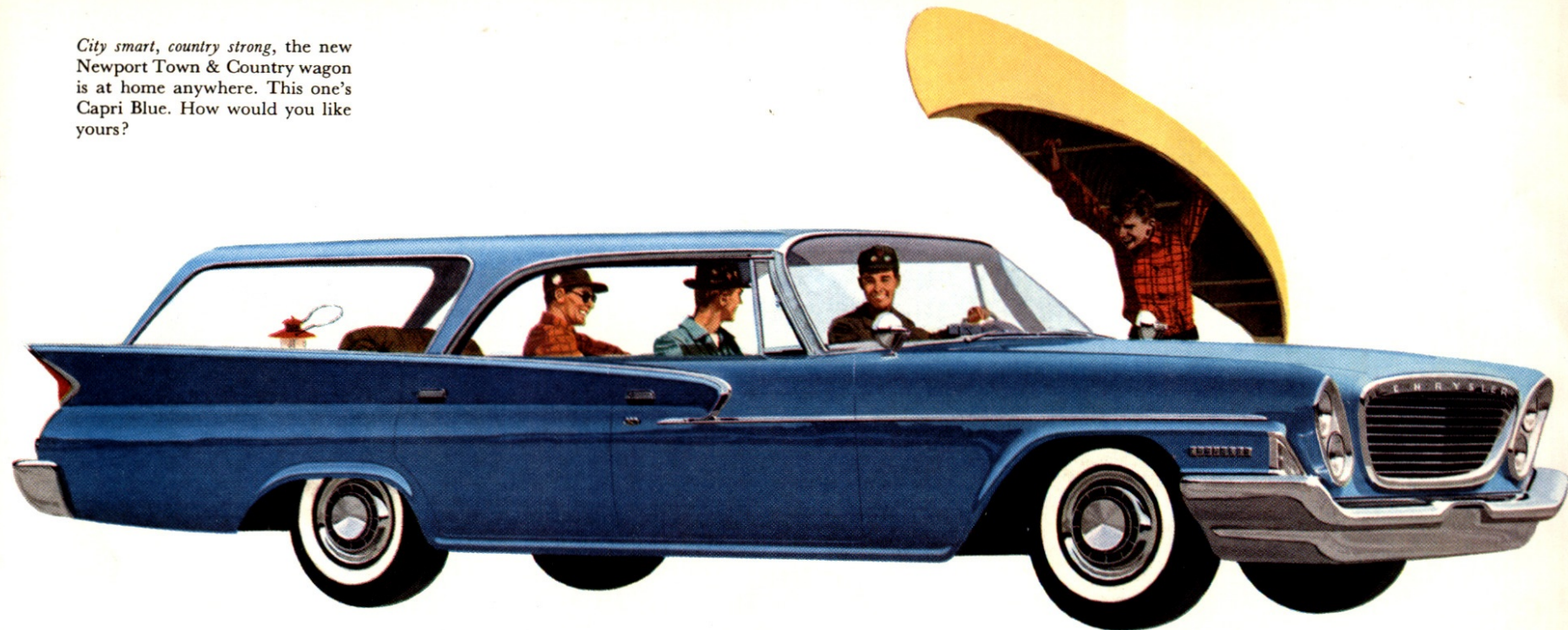

The Chrysler Newport—priced within your reach



Two-way treat, this Sahara Sand Newport convertible is as spacious and snug as a hardtop with the top up. Top down, the sky's the limit on excitement.

Chrysler's Unibody combines the usual separate body and frame in one integrated unit. Result:

**Strength!** In a body-frame car, the frame provides most of the strength and the body's main purpose is housing the passengers. In a Unibody Chrysler the body, itself, provides the strength.

Laboratory tests comparing Chrysler with a conventional body-frame car proved Chrysler 40% stronger, 100% more resistant to twisting!

**Quietness!** Body-frame cars are apt to squeak and rattle when the body rubs against the frame. Unibody is a single piece, scientifically "tuned" to

reduce vibrations . . . blanketed with ninety-five pounds of sound-deadening material.

**Roominess!** Those fat frame members on conventional cars take up room. By eliminating them, Unibody allows lower floors, higher seats, more stretch-out comfort.

**UNIQUE UNIBODY CONSTRUCTION MAKES CHRYSLER STRONGER, QUIETER, ROOMIER**

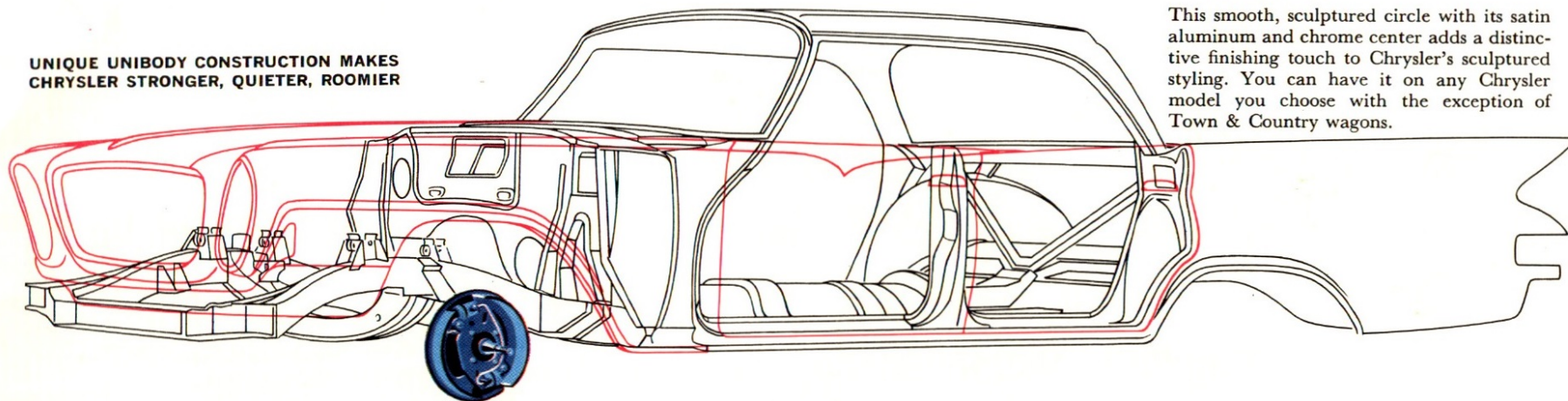

**FLIGHT-SWEEP LID**

This smooth, sculptured circle with its satin aluminum and chrome center adds a distinctive finishing touch to Chrysler's sculptured styling. You can have it on any Chrysler model you choose with the exception of Town & Country wagons.

**SIX DIPS SEAL OUT RUST**

The rolled steel that goes into a Chrysler is scrubbed spotlessly clean before the car is stamped and assembled. Once Unibody is built, it's dipped six times in rust-resistant chemicals and rinses. Every nook and cranny, outside and inside, is coated with a tough, protective shield that seals out rust for years and years.

**BIGGER, BETTER BRAKES**

The Total-Contact brakes on Chrysler are the biggest in its class with up to 251 sq. in. of area. Two cylinders in front brakes insure that all the lining grips the drum.

**SMOOTHER, SAFER RIDE**

Chrysler's Torsion-AIRE suspension uses straight, strong torsion bars in place of the usual front coil springs. Instead of bouncing up and down, they soak up bumps in a horizontal, twisting motion. You get a smoother ride and surer, safer steering. Auto experts applaud Torsion-AIRE. One drive and you will, too.

**MORE MILES FOR YOUR MONEY**

The 361 cu.-in. Windsor V-8 runs on regular gasoline! The 383 cu.-in. Saratoga V-8 has an efficient 2-barrel carburetor. Both have short strokes for less wear. And the 413 cu.-in. V-8 in the New Yorker is the 1961 version of the one that won first in its class in last year's Mobilgas Economy Run.

**HARDEST CAR FINISH KNOWN**

Two coats of primer are baked on each Chrysler's outside surface and wet-sanded by hand to glossy smoothness. Then two coats of Lustre-Bond enamel are baked on top of the primer. Result: the hardest automotive finish known. Highly resistant to fading and chipping, it stays looking showroom new without polishing or waxing.

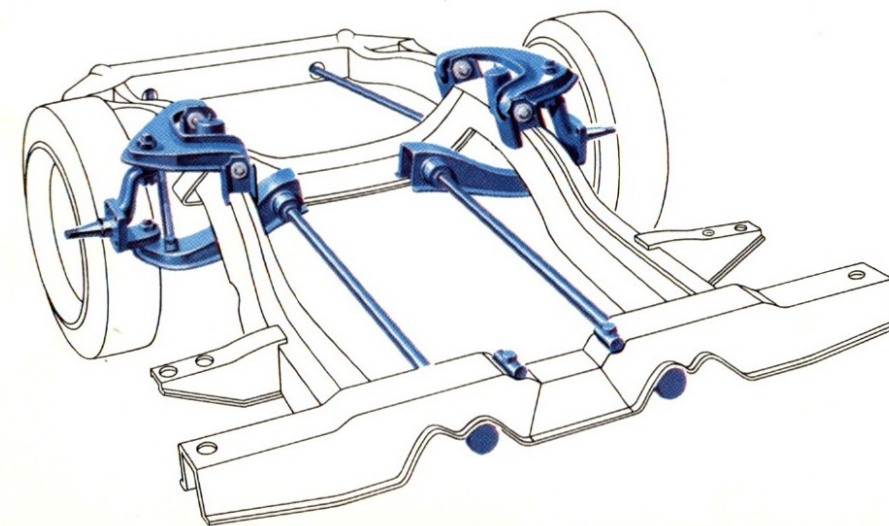

**Every Chrysler** is built from the bottom up to drive better and last longer. Constructed as a solid, single unit instead of a separate body and frame, Chrysler is far stronger and quieter than conventional cars. Dipped six times in rust-resistant chemicals and rinses, it sports a tough protective shield against corrosion outside and in. Torsion bars instead of the usual front coil springs make Chrysler ride smoothly, steer safely. The brakes are bigger . . . feel surer . . . than the brakes on competitive cars. When you drive it, you'll know that Chrysler has no use for compromise, for "next-best" or "as-good-as". Do you?



Green with envy is how your friends will feel when they see you in this Green Saratoga sedan.

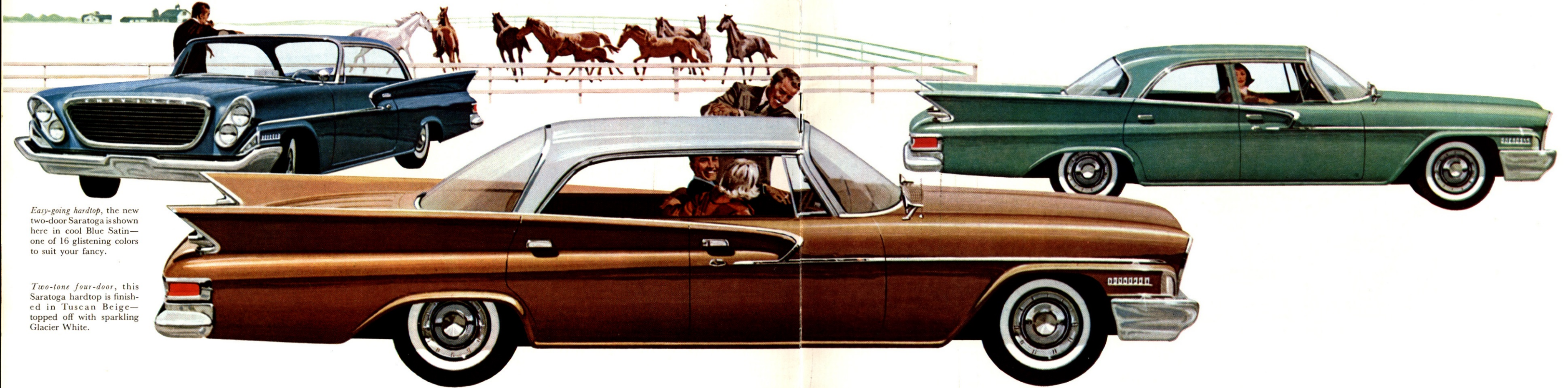

Easy-going hardtop, the new two-door Saratoga is shown here in cool Blue Satin—one of 16 glistening colors to suit your fancy.

Two-tone four-door, this Saratoga hardtop is finished in Tuscan Beige—topped off with sparkling Glacier White.

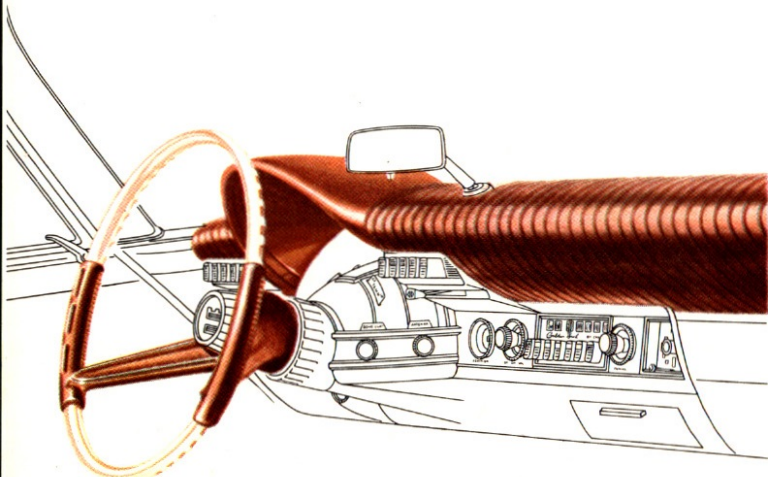

← Chrysler's AstraDome control center places controls at your fingertips, makes instruments easy to read. Push-buttons located at the left of the steering wheel operate Chrysler's TorqueFlite automatic transmission. Pushbutton controls for the optional heater and radio are at the right. Instruments are housed in a three-dimensional setting so you can see them at a glance.

Decorate your Saratoga with vinyl bolsters and pleated fabric cushions. This tan vinyl and brown fabric combination is one of four available. You can also have red or white all-vinyl on hardtops at extra cost. Door panels repeat the vinyl-fabric motif of the seats. Wide rear seat and low tunnel mean room for three to ride in comfort. High front seat supports the driver knee to shoulder.

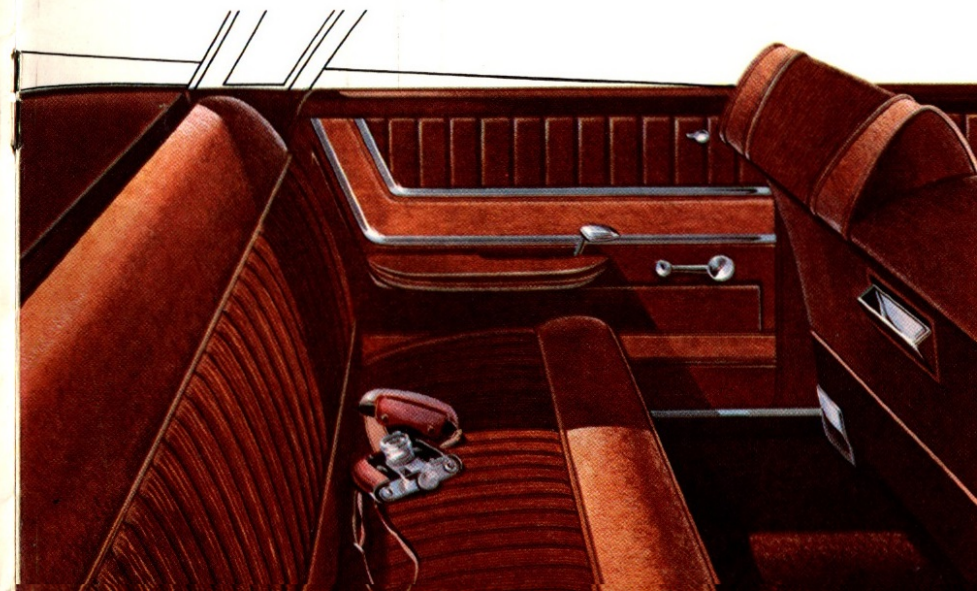

## The Chrysler Saratoga

Who says a high-performance car can't be comfortable? Let the Saratoga prove it can! You get every creature comfort—shoulder-high driver's seat, stretch-out room for six, designer fabrics, deep foam cushion, complete appointments. And you get them in a car that's born for driving. Three hundred and eighty-three cubic inches of engine swallow the miles without guzzling gas. Straight torsion bars in place of the usual front coil springs take the squat out of starts, the lean out of turns, the dive out of stops. You can have your comfort and drive it, too, if your car's a Chrysler Saratoga.



Uninterrupted vision is the beautiful result of this New Yorker Town & Country's hardtop styling. Below, in Cinnamon.

## The Chrysler New Yorker

Raise the roof in this Alaskan White New Yorker convertible. Top up, it's snug as a sedan.

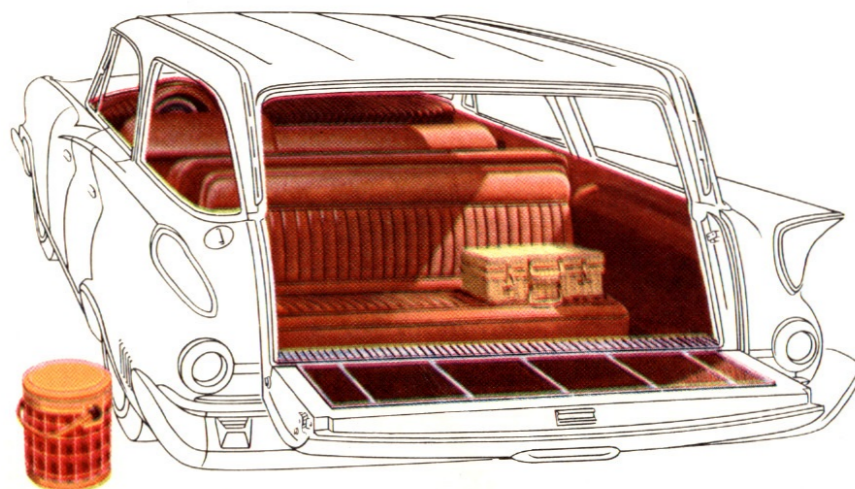
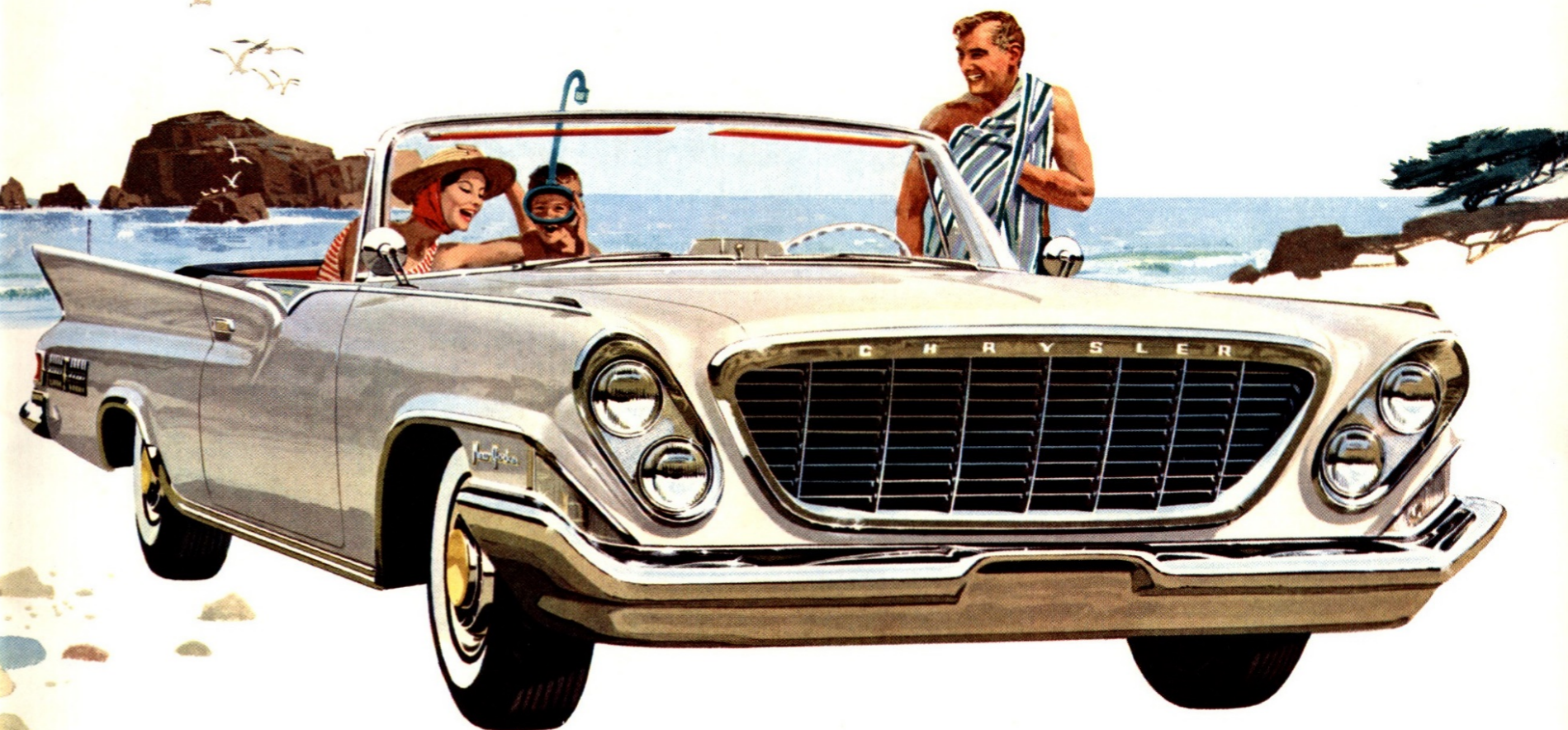
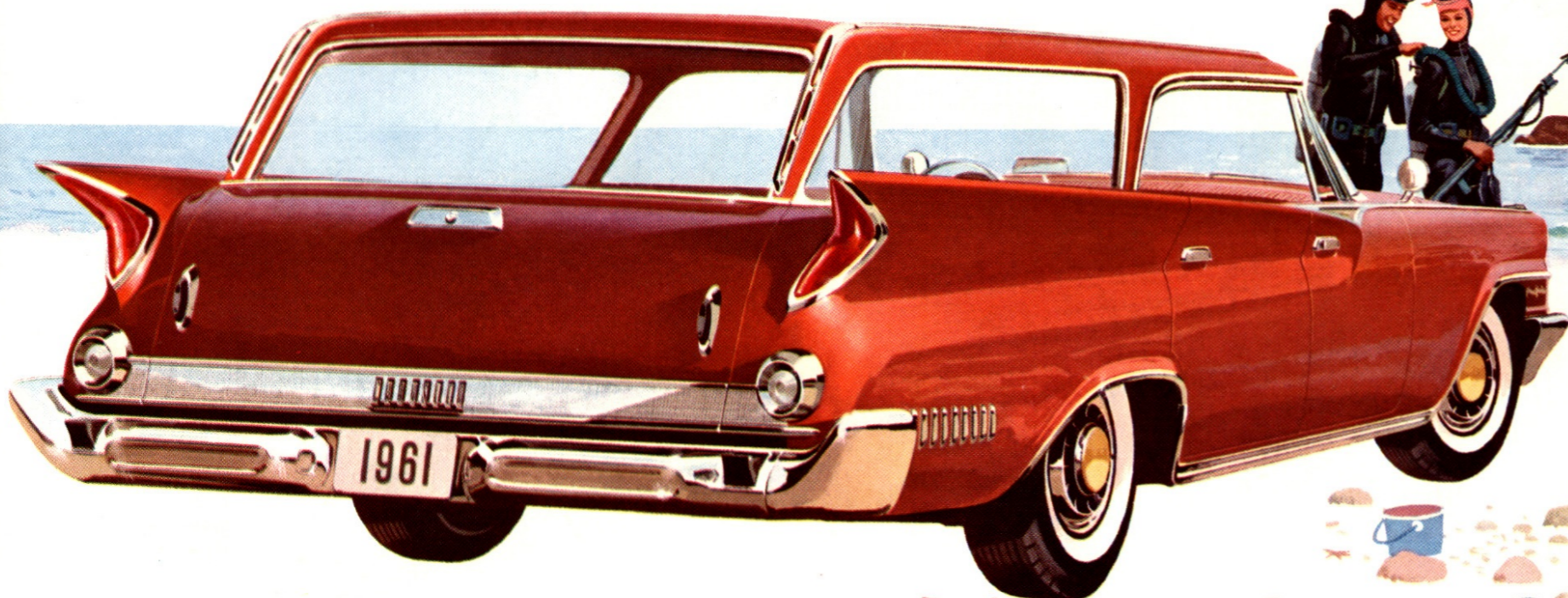

← The rear-facing third seat in nine-passenger New Yorker wagons folds quickly out of sight when not in use. (Choose scuffproof all-vinyl upholstery or vinyl with fabric cushions.) Ninety-five cubic-foot cargo capacity means you *can* take it with you. Deep-pile carpeting down the deck protects fine luggage. The rear window raises or lowers at the flick of a switch on the instrument panel.

→ Handsome vinyl upholstery, stitched over biscuit-shaped bolsters, is standard equipment on New Yorker convertibles and wagons. Interesting basket-weave texture permits the material to "breathe"—keeps you comfortably cool on the warmest top-down days. Wide door openings make ins and outs easy. Wide seats give you all the room and comfort of a hardtop.

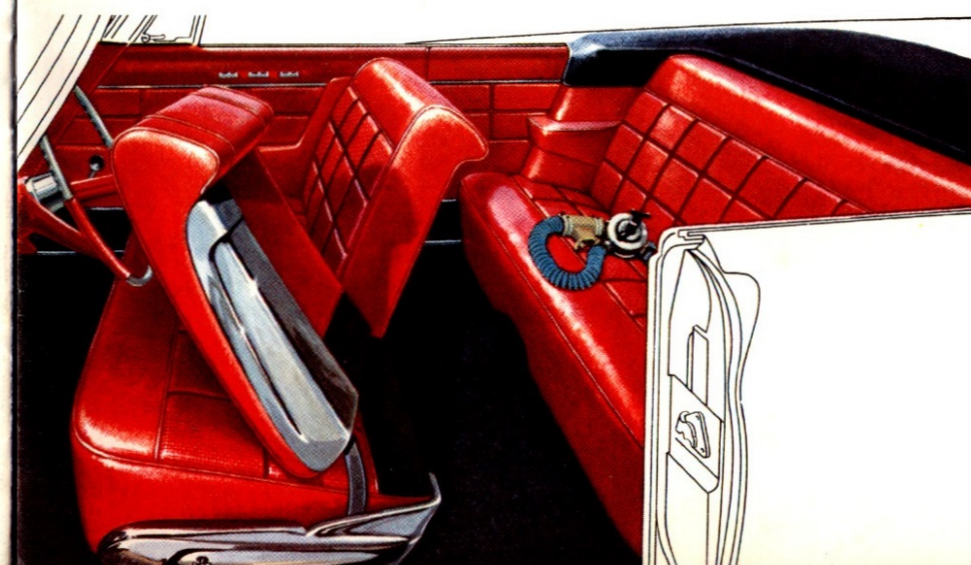

Whether you're wearing a sports jacket or dinner jacket, you'll feel at home in one of these two New Yorkers. The Town & Country is the most spacious, most powerful wagon made. Yet it surrounds you with the thoroughbred beauty, comfort and convenience of a fine sedan. The convertible, too, is a dual personality, combining hardtop roominess and quietness and luxury with a top that opens or closes to match your mood. You'll find either of these New Yorkers one of the most satisfying cars you can own—because it's so superbly made, because it's such sheer fun to drive.



# 1961 Chrysler Accessories

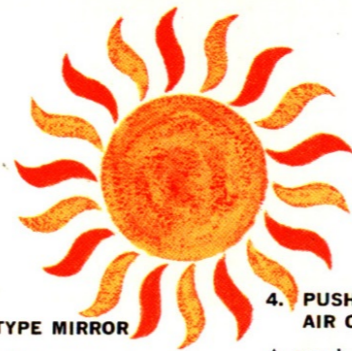

## 1. REMOTE-CONTROL OUTSIDE MIRROR

Move the control inside, and the mirror moves outside to suit your angle of vision. This accessory is especially convenient if more than one person drives your car. (Standard on New Yorkers. Optional on Windsor and Saratoga.)

## 2. CONSTANT-CONTROL POWER STEERING

Works full-time to make driving and parking fingertip easy. Gives firm, accurate feel of the road. (Standard on New Yorkers. Optional on Windsor and Saratoga.)

## 3. TILT-TYPE MIRROR

Lets you flick away dangerous headlight glare from cars coming up behind you. (Standard on New Yorkers. Optional on Windsor and Saratoga.)

## 4. PUSHBUTTON AIR CONDITIONER

A touch sets the temperature. Changes air completely once a minute. Choose single or dual model with cooler in the back as well as the front of the car. (Single model not available on Town & Country wagons, dual model not available on convertibles, optional on New Yorker.)

## 5. POWER DOOR LOCKS

Flick a switch and all four doors lock automatically for peace of mind when there are children aboard or the lady of the house drives alone.

## 6. ELECTRIC CLOCK

Split-second accurate, completely quiet and dependable. (Standard on New Yorkers and Saratoga. Optional on Windsor.)

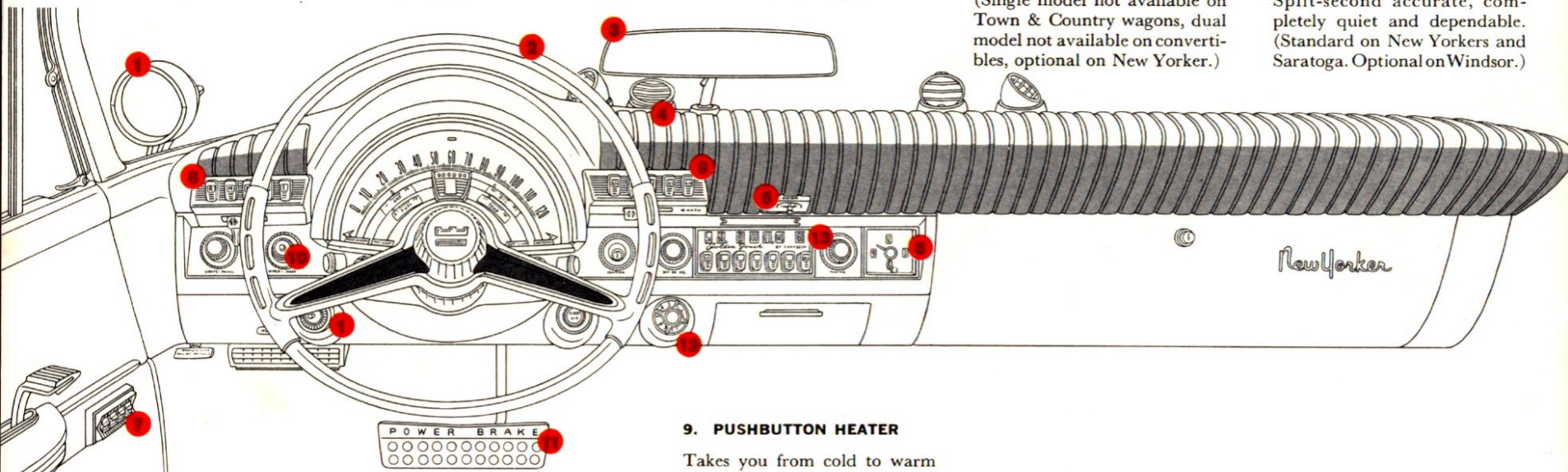

## 7. POWER WINDOWS

You can control all four windows electrically, from the driver's seat. Each passenger also has a control of his own.

## 8. PUSHBUTTON AUTOMATIC TRANSMISSION

Chrysler's TorqueFlite transmission puts pushbutton controls at your fingertips. Works trigger-quick. Glides from gear to gear without a jerk. (Standard equipment.)

## 9. PUSHBUTTON HEATER

Takes you from cold to warm comfort in minutes. Accurate thermostat maintains the temperature you set.

## 10. PUSHBUTTON WINDSHIELD WASHER

Coupled with wide-sweeping, 16-inch electric wipers, this Chrysler option is a must for foul-weather driving. (Standard on New Yorker. Optional on Windsor and Saratoga.)

## 11. TOTAL-CONTACT POWER BRAKES

A touch of your toe brings you to a straight, smooth stop. Wide pedal lets you brake with your left foot. (Standard on New Yorkers. Optional on Windsor and Saratoga.)

## 12. AUTOMATIC AUTO-PILOT

Lets you drive with your foot off the gas. Holds any speed you set until you touch the brake. Takes over again when car returns to set speed. Takes the dangerous tedium out of turnpike driving. Also serves as a reminder of speed limits. (Optional on New Yorker and Saratoga.)

## 13. PUSHBUTTON RADIO

A touch tunes you in. Choose from two Chrysler transistor radios: The Golden Tone. Or the Golden Touch Tuner (imported models only) that lets you change stations with a foot-operated button, comes complete with a power antenna and rear-seat speaker.

# Specifications

Tailor your Chrysler to suit yourself with this world of accessories. Make driving a soft touch with push-button controls. Take the work out of parking and stopping with power steering and power brakes. Complement Chrysler's styling with a circular rear deck lid. Each accessory makes Chrysler more fun to own . . . worth more come time to trade.

## SWIVEL SEATS

Touch a lever, and the seat swings out to meet you. Sit down and swing inside. (Available only on New Yorkers and convertibles. Not available on wagons.)

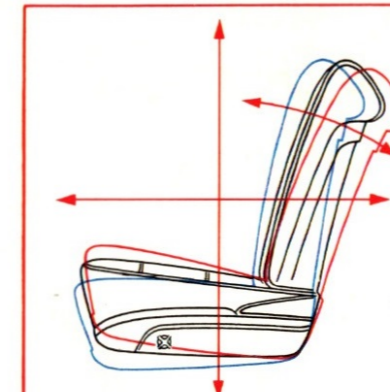

## SIX-WAY POWER SEAT

It moves any direction you move the control on the driver's seat. Cuts fatigue on trips. Great when drivers take turns.

## SURE-GRIP DIFFERENTIAL

Gives your Chrysler sure footing on snowy, icy, muddy or wet roads. Transfers power to the wheel getting the most traction and walks you right out of trouble.

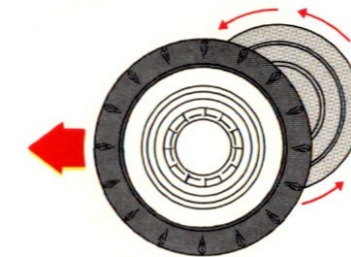

## TINTED GLASS

Softly tinted to shield against the sun's rays, it keeps car cool and gives you a glare-free view. Available for all windows, on every Chrysler.

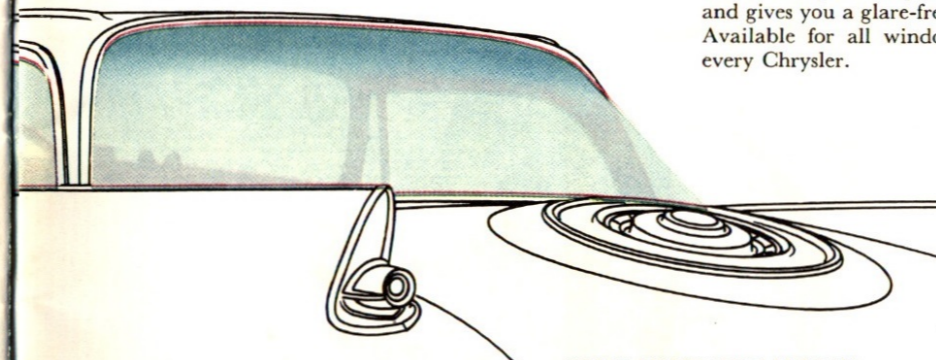

## EXTRA-LARGE REAR WINDOW

Looks great outside—lets you see more from the inside of your Chrysler four-door hardtop. Shaded at the top, it keeps passengers cool. (Standard on 2 door and 4 door hardtops.)

# Specifications

**Engines**—Golden Lion V-8, 90-degree lateral. Bore and Stroke: Windsor—4.12 x 3.38, 361 cubic inches; Saratoga—4.25 x 3.38, 383 cubic inches; New Yorker—4.18 x 3.75, 413 cubic inches. Compression ratio: Windsor—9.0 to 1; Saratoga and New Yorker—10.1 to 1. Horsepower: Windsor—265; Saratoga—305; New Yorker—350.

**Transmissions**—Pushbutton TorqueFlite, fully automatic torque converter with 3-speed gear set, standard.

**Suspension**—Time-tested Torsion-AIRE suspension, standard. Ball-joint pivots (front) with Oriflow shock absorbers.

**Fuel System**—Carburators: dual down-draft on Windsor and Saratoga, four-barrel down-draft on New Yorker. Automatic intake manifold heat control, automatic choke, dual filtration units. Fuel capacity—19.1 Imperial gallons. 18.3 Imperial gallons for Town & Country Wagons.

**Electrical System**—Battery: 12-volt, 66-plate, 60-amp-hr. on Windsor and Saratoga; 12-volt, 78-plate with 70-amp-hr. on New Yorker. Generator: 35 amps. Waterproof ignition. Electric windshield wipers and directional signals. Dual headlights, standard.

**Cooling System**—Thermostatic by-pass control. Pressure vent radiator cap. Coolant ca-

capacity, 14.5 Imperial quarts on Windsor, Saratoga, and New Yorker.

**Brakes**—Total-Contact with Cyclebonded lining. Drum diameters: 12" on New Yorker and all Town & Country Wagons, 11" on Windsor and Saratoga. Power brakes standard on New Yorker; available at extra cost on all Windsor and Saratoga models.

**Steering**—Manual, worm and 3-tooth roller, standard on Windsor and Saratoga. Constant-Control power steering with quick 3½ turns lock-to-lock, standard on New Yorker, available on Saratoga and Windsor.

**Drive**—Hotchkiss drive through rear springs. Hypoid rear axle with 2.93 to 1 ratio.

**Wheels and Tires**—Safety-Rim wheels. Standard tire sizes: Windsor and Saratoga—8.00 x 14, except Newport Town & Country Wagon, 8.50 x 14; New Yorker—8.50 x 14, except Town & Country Wagon, 9.00 x 14. White sidewall and Captive Air tires (wagons only) also available. Chrome stainless wheel covers standard.

**Dimensions**—Wheelbase: Windsor and Saratoga—122", New Yorker—126". Over-all length: Saratoga and Windsor—215.6", New Yorker—219.8". Width: 79.4". Tread: Saratoga and Windsor—61.0" (front), 59.7" (rear); New Yorker—61.2" (front), 60.0" (rear).

## AND MORE ACCESSORIES

For the Windsor, Saratoga and New Yorker: ■ white sidewall tires ■ undercoating and hood insulating pad ■ rear window defogger (not available on convertible, Town and Country) ■ rear radio speaker (not available on Convertible, Town and Country) ■ power radio antenna ■ door edge protector\* ■ rear license plate frame\* ■ vanity mirror ■ dual exhaust ■ captive air tires (Town and Country only).

\*New Yorker only.

For Windsor and Saratoga ■ Rear Bumper Guards.

For Windsor: ■ Sill Moulding and Stone Shields

■ Door Top Moulding on Sedans.

**NOTE:** Constant improvement of its products requires Chrysler Corporation of Canada, Limited, to reserve the right to change prices, specifications and standard equipment without obligation, from time to time, and without notice. Certain special equipment is shown on the vehicles illustrated in this catalogue but your local dealer will gladly advise you of those items that are standard.



Chrysler '61 C

Chrysler '61 Chry

Chrysler for '61 — Windsor . . . Saratoga . . . New Yorker

Chrysler '61

Chrysler '61 Ch



The Chrysler Windsor—full size and full value



New ribbed rear deck forms the happy ending of the Windsor four-door hardtop, shown here in solid Sparkle Silver.



Room with a view, this Windsor four-door sedan is finished in Turquoise—one of 16 colors and 46 combinations in the Chrysler rainbow.

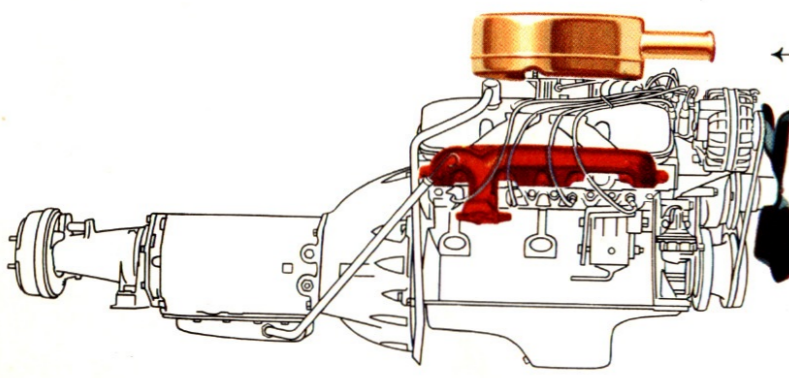

Now you can get more miles per dollar with the Chrysler 361 cubic inch engine, designed to deliver peak performance and economy on regular gasoline. In many areas of Canada, this economy enables you to save as much as a dollar a tankfull! The engine is cushioned (front and rear of transmission) on a coil spring encased with rubber for smooth, quiet operation.

Clothe your Chrysler Windsor in one of four different cloth and vinyl combinations, each colour keyed to an outside enamel. All vinyl upholstery is standard on Newport convertible and wagon. On all Chryslers, the height and angle of the front seat can be custom-positioned in six different ways by your dealer to your individual comfort.

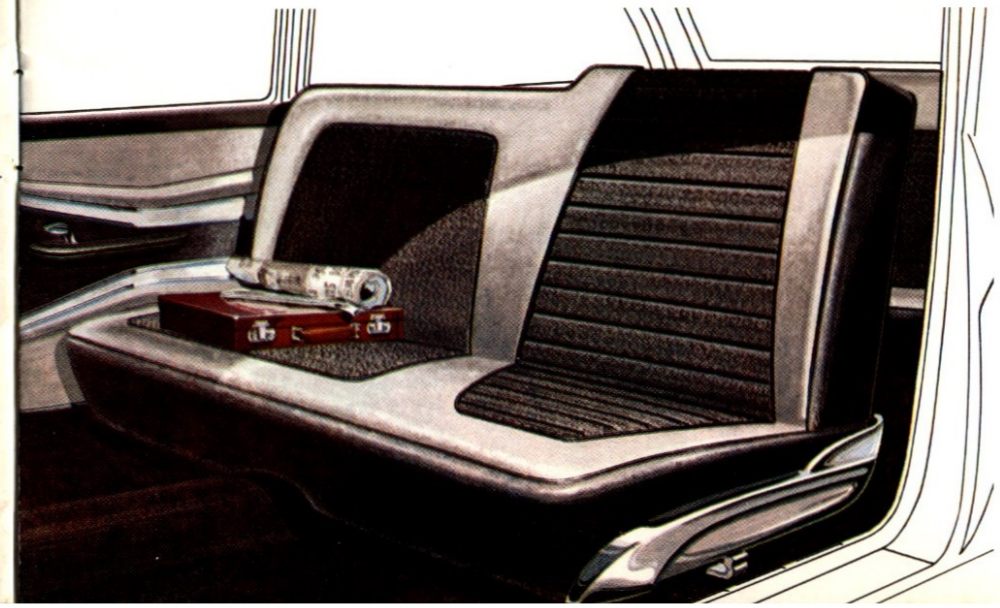

Who'd think to see it, or sit in it or drive it, that the Windsor is the easiest-to-own Chrysler of them all. Feast your eyes on canted headlights, clean contours, tasteful trim—styled to stay in style. Slip inside and take your ease on five-foot-wide seats finished in long-wearing, double-woven fabrics. Take the wheel and see how torsion-bar suspension takes the squat and dive out of starts and stops . . . how the V-8 engine loafs at turnpike limits on *regular* gasoline! You save money when you buy the Windsor. You save more money every mile you drive it! Can you afford less?





New colors for the New Yorker include delicate Dubonnet, here gracing a two-door hardtop. Distinctive grille is extruded aluminum.

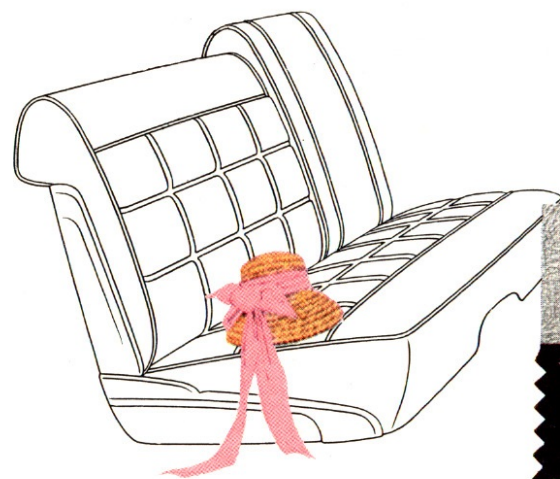

Left and center, vinyl and nylon combinations are standard on New Yorker hardtops and wagons. Near left, the all-vinyl trim, standard on convertibles and extra cost on hardtops.

New Yorker sedans offer deep-nap wool broadcloth in solid blue, right, and gray, center. Or you can choose rich nylon fabrics set into broadcloth bolsters, such as the black and gray combination at the far right.

Black beauty, new razor-edge roof line and extra-large rear windows distinguish the New Yorker four-door hardtop.

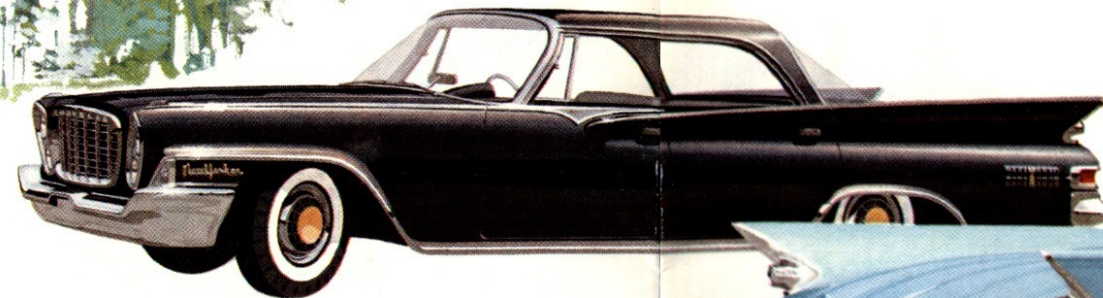

Beauty marks, ten lustrous louvers identify the New Yorker. This is the four-door sedan, decked out in Persian Blue.

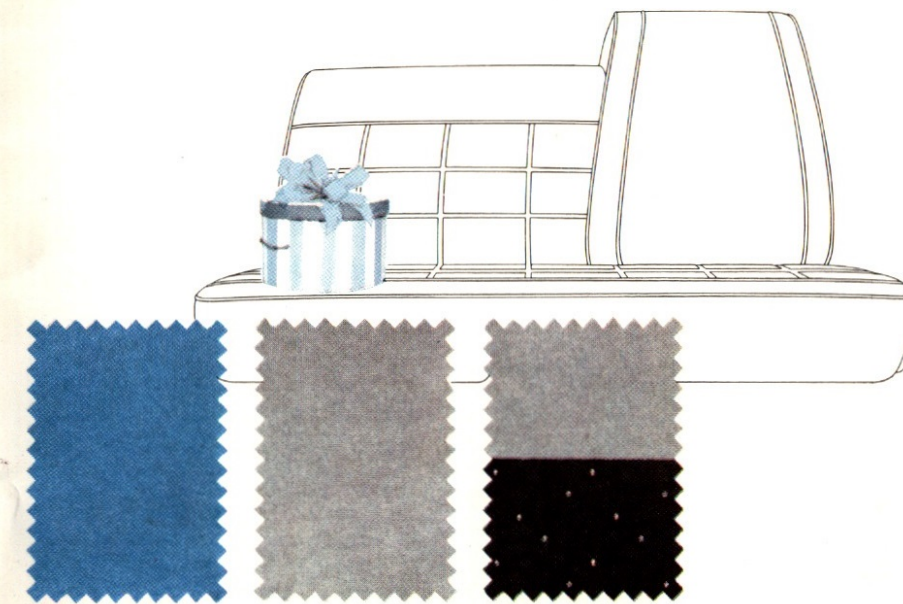
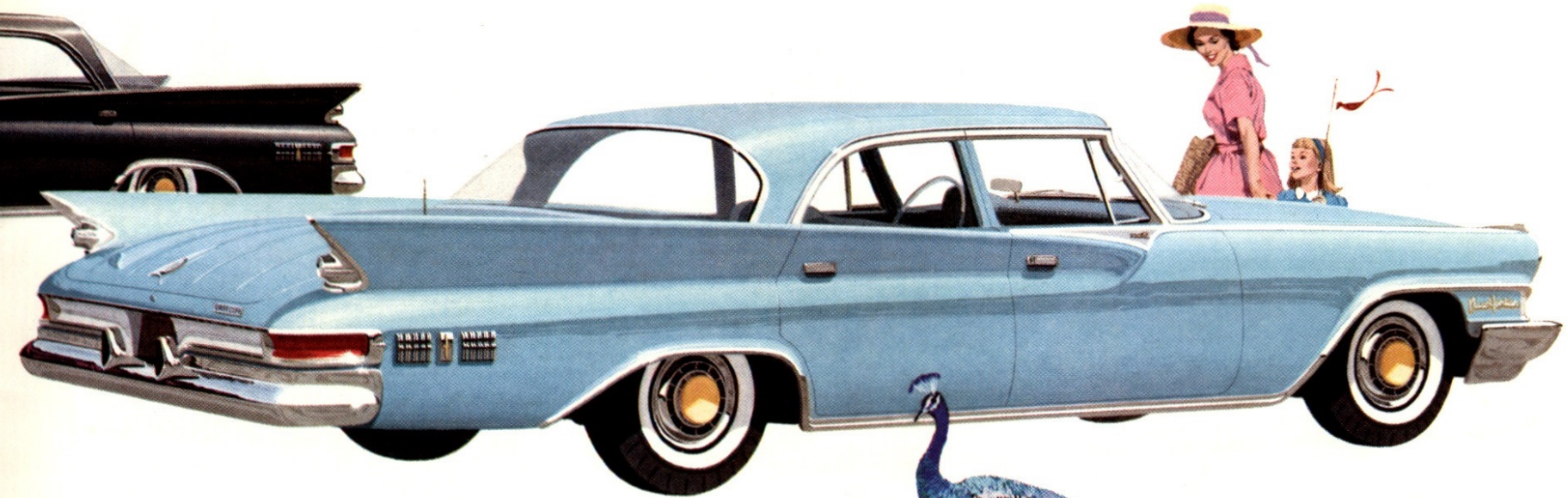

## The Chrysler New Yorker

Sculpture in metal so faultless no chrome camouflage is needed. Sitting room on wheels that flatters you with the same fine fabrics, soft cushions and thick carpets you're used to at home. Thoughtful servant that pampers you with a pushbutton automatic transmission, power steering, power brakes and remote-control mirror. Working partner that combines every excellence known to automotive engineering to carry you quickly, quietly, effortlessly anywhere. Drive this New Yorker. Weigh it against any car you've known before. See for yourself why it's unquestionably Chrysler's finest.



Chrysler '61 Chrysler '61 Chrysler '61 Chrysler '61 Chrysler '61 Chrysler '61 Chrysler '61 Chrysler '61 Chrysler '61 Chrysler '61

Chrysler for '61 — Windsor . . . Saratoga . . . New Yorker

LAWSON OATES ON BROADWAY  
TELEPHONE REGENT 6-5521