

The 2013 M-Class



Mercedes-Benz
The best or nothing.

A champion among luxury SUVs.

The 2013 M-Class is a dynamic presence both on and off the road. Whether driving through rough terrain or cumbersome city roads, this impressive vehicle provides a comfortable ride even when the conditions are not. Modern, stylish and void of the ordinary, the 2013 M-Class will exceed your expectations.

The M-Class

DESIGN	2
ENTERTAINMENT COMMUNICATION	
AGILITY	10
BlueE CIENC 4MATIC™	14
SA ET	1
AMG	1
COLOURS MATERIALS	22
ACCESSORIES OWNERSHIP	2
WEBSITE TEST DRIVE E E IPMENT LISTING AND TECHNICAL SPECIFICATIONS	2





ML 550 4MATIC™.

Assured beauty in confidence.

An unmistakable aura of power emanates from the M-Class. Situated handsomely with an aggressive AMG styled body, triple-louvre radiator grille with the embedded three-point star, and a large chrome-style under-guard at the front and rear. With the body contours accented by cool-white LED daytime running lights and 19" 5 twin-spoke wheels, the ML 350 BlueTEC stands as proof that beauty is not only in the eye of the beholder.





ML 350 BlueTEC with active Bi- xenon headlamps.

It's all in the details.

The same attention to aesthetics applies to the ML 550 4MATIC™. Dynamic body lines are accented by cool-white LED daytime running lights and 20" 5-spoke wheels, making it the most beautiful form of refined power, both on the road and off. Its characteristic body design – cast from a single mould – features elongated lines running along its sides, continuous tail lamps, and a harmonious transition from the rear side windows to the rear window capped under the hallmark M-Class style C-pillar.



Bi-Xenon headlamps with LED daytime running lights.





ML 550 4MATIC™.



ML 350 BlueTEC interior shown with Brown Ash Wood (open-pore).



Make yourself comfortable.

The ML 350 BlueTEC features rich ARTICO leather covered door panels and ergonomic seats along with a finely appointed wood trim and chrome details, promising a sporty, elegant and high-quality interior character. Optional highlights include Climate comfort front seats, Heated rear seats, Panoramic sunroof and Wood/Leather steering wheel, providing further comfort, spaciousness and interior luxury.

The ML 550 4MATIC™ offers even more interior comforts and details – from the standard Leather upholstery and ARTICO dashboard to the optional *designo* Wood/Leather steering wheel and optional multicontour front seats with massage, character and comfort shine throughout every corner.



Ambient lighting with polar, neutral and solar colour settings.

Get the show on the road. Or off.

The 2013 M-Class provides entertainment and convenient communication technology. With the COMAND APS with HDD navigation and DVD changer¹ and harman/kardon[®] LOGIC7[®] surround sound system², confident navigation and crystal clear onboard entertainment allow for a pleasurable and easily navigated drive.

Integrated into your vehicle's audio system, SiriusXM is standard and includes a 6 month complimentary subscription³ featuring over a 120 channels of the best in audio entertainment. Get 100% commercial-free music from every genre, plus sports, news, talk and comedy – all with crystal-clear, coast-to-coast coverage.

Additionally, the available Media interface¹ syncs with your iPod[®] to let you browse artist album artwork similar to your iPod[®].



¹Standard on the ML 550 4MATIC™ and the ML 63 AMG. Available as part of an option package on the ML 350 models. ²Available as part of an option package on the ML 350 models and the ML 550 4MATIC™. Standard on the ML 63 AMG. ³Complimentary service is comprised of a SIRIUS package. Monthly subscription required for service thereafter. © 2012 Sirius XM Canada Inc. "SiriusXM", the SiriusXM logo, channel names and logos are trademarks of Sirius XM Radio Inc. and are used under licence.





COMAND APS with HDD navigation and D D changer.



ML 350 4MATIC™.



Pick your power.

Hidden beneath the ML 350 4MATIC™'s broad, chiselled hood lies a momentous powerplant – the 3.5 L direct injection V6. With an amazing 302 horsepower and 273 lb-ft of torque, this engine offers excellent performance. What's more, it comes mated to the 7G-TRONIC PLUS automatic transmission for smooth, optimized gear shifting.

The ML 350 BlueTEC comes with the 3.0 L Turbo V6 diesel engine, revised for greater power and efficiency. It delivers an impressive 240 horsepower, 455 lb-ft of torque delivering outstanding towing capacity and fuel efficiency.

The ML 550 4MATIC™ provides even more power with a 4.6 L Bi-turbo engine offering 402 hp and 443 lb-ft of torque. A compact and low-weight design reduces friction loss and optimizes fuel consumption.



3.5 L direct injection V6.

Ride like you are on air.

The M-Class takes driving enjoyment to new levels – literally – with AIRMATIC with Adaptive Damping System (ADS)¹. When travelling at high speeds, the ride height of the M-Class is automatically lowered, minimizing drag, reducing fuel consumption and improving handling. When travelling with a heavy payload, the air suspension keeps the ride height of the vehicle constant at all times. With its two manually selectable damper settings: ‘Sport’ and ‘Comfort’, comfort and control are never a concern.

Take comfort to a whole new level.

The M-Class is fitted standard with the 7G-TRONIC PLUS 7-speed automatic transmission. Gears are selected directly, ensuring uninterrupted torque delivery, virtually imperceptible shifts and enhanced ride comfort. Should you need to brake sharply or accelerate quickly, gears can be skipped to allow for quick manoeuvrability. 7G-TRONIC PLUS 7-speed automatic transmission also allows you to downshift manually using the shift paddles on the steering wheel if you'd like even more control over gear selection.

What comes between you and the road.

The M-Class wheels were designed with the same philosophy as the rest of this inspired vehicle. Style, substance and safety are the cornerstones of Mercedes-Benz, and none of these attributes were spared while developing these impressive wheels.



19" 5 twin-spoke wheels²



20" AMG 5-spoke wheels³



21" AMG 5 twin-spoke wheels⁴



21" AMG 5 twin-spoke wheels (Code 798)⁵

¹Standard on the ML 550 4MATIC™ and the ML 63 AMG. Available as part of an option package on the ML 350 models. ²Standard on the ML 350 models. Not available on the ML 550 4MATIC™ and the ML 63 AMG. ³Standard on the ML 550 4MATIC™. Available as part of an option package on the ML 350 models. Not available on the ML 63 AMG. ⁴Available as part of an option package on the ML 550 4MATIC™. Not available on all other models. ⁵Standard on the ML 63 AMG. Not available on all other models.



The innovative Adaptive Damping System (ADS) ensures stability and control are never a concern.



Increased performance. Reduced emissions.

Performance meets fuel economy. Luxury meets responsibility. At Mercedes-Benz, we don't believe in compromise. Our BlueEFFICIENCY philosophy ensures that environmental responsibility plays a major role in all we do. This applies to all levels of vehicle development and production. We take a comprehensive approach to all the potential factors relating to drive systems, lightweight construction, energy management and fuels. The 3.0 L Turbo V6 diesel engine on the ML 350 BlueTEC is no exception. This engine has been revised for greater power and efficiency, delivering an impressive 240 hp and 455 lb-ft of torque. Seamless performance and rigorous fuel economy allow the ML 350 BlueTEC to meet even the strictest emission regulations.



Permanent confidence. Relentless control.

Our 4MATIC™ permanent all-wheel drive system gives you excellent control over your M-Class, for complete confidence no matter what the season or road conditions. It is always engaged, sending torque to each wheel independently and ensuring optimal traction and control. 4MATIC™ is aided by our 4-wheel Electronic Traction System (4ETS). 4ETS monitors each wheel for the first sign of wheel slip. It then individually brakes the slipping wheels to maintain the perfect balance of power and traction. By continuously ensuring that power goes only to the wheels with grip, 4ETS can help keep you moving, even if only one wheel has traction.



4MATIC™ offers confident and advanced traction in the most challenging weather conditions.

Safety should never be left to chance.

The M-Class' extremely sturdy passenger cage protects occupants by way of energy-absorbing front-end, reinforced doors, extended crumple zones, and an elevated ride position. Passive Blind Spot Assist¹ monitors vehicles around you when travelling over 30 km/h². If a vehicle remains in your blind spot for more than 1.5 seconds, a warning triangle appears on the exterior side mirror. The Electronic Stability Program (ESP[®]) enhances control by monitoring your steering and braking, making instantaneous adjustments if it senses loss of control or stability. Seatbelts feature Emergency Tensioning Devices (ETDs) to help remove seatbelt slack in more severe front or rear impacts. Rest assured, driving an M-Class means driving protected.



COLLISION PREVENTION ASSIST reduces the chance of rear end collisions by automatically alerting the driver in the event of danger.



Passive Blind Spot Assist alerts the driver if it identifies a risk of a collision while the vehicle is changing lanes.

¹Standard on the ML 63 AMG. Available as part of an option package on the ML 350 4MATIC[™], ML 350 BlueTEC and the ML 550 4MATIC[™]. ²No system, regardless of how advanced, can overcome the laws of physics or correct careless driving. Please always wear your seat belt. Best performance in snow is obtained with winter tires.

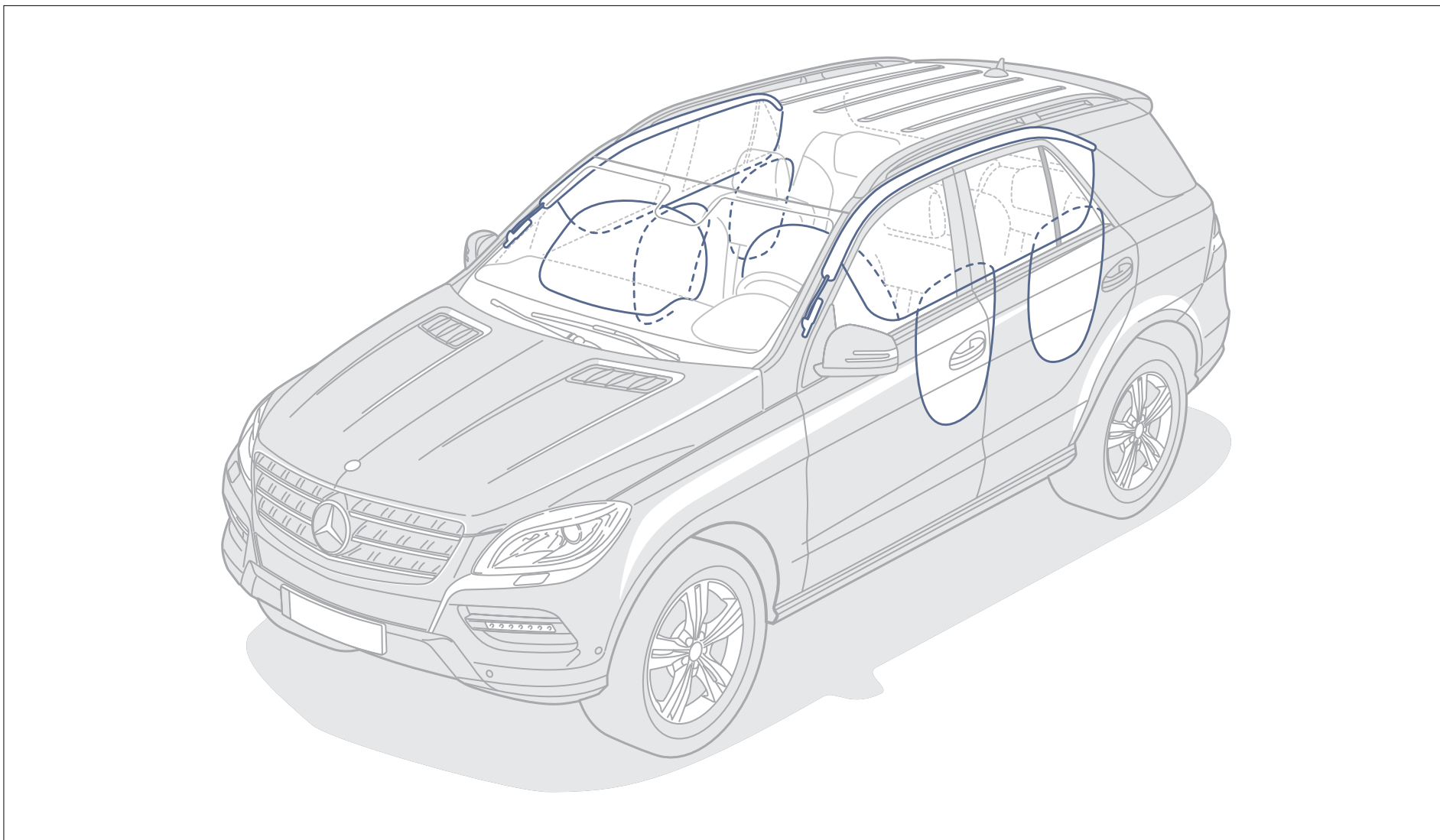

Dual stage front airbags, front side airbags, front pelvic airbags, driver's knee airbag, head protection curtain airbags and rear side airbags provide substantial protection for all occupants in the event of a collision.



Aggressive and powerful with a commanding presence: The ML 63 AMG.

Engineered for effortless superiority.

Handcrafted precision. Dynamic performance. Luxury and style. Classic lines with just a hint of aggression. And most of all: passion. These are the elements of the philosophy behind every Mercedes-AMG vehicle. Our engineers and Master Mechanics always take it one step further – second best is never good enough. The ML 63 AMG has been designed to fulfill every

desire of even the most demanding driver – both in performance and aesthetics. After all, beauty is more than skin deep.

At first sight, the aggressive front of the ML 63 AMG instantly draws attention to itself: the distinctive AMG front apron with large air intakes and matte chrome

trim combined with flared wheel arches provide a powerful appearance. For even more character, the AMG side skirts and AMG rear-apron continue the look, while the AMG 21" 5 twin-spoke wheels complete it.



A dominant and sporty rear attracts attention while providing a characteristic look.

Thrills with unbridled power.

When it comes to performance, the ML 63 AMG sets the benchmark; on or off-road. In combination with the AMG SPEEDSHIFT PLUS 7G-TRONIC transmission, the AMG 5.5-litre V-8 Bi-turbo engine with 518 horsepower and 516 lb-ft of torque assures the greatest driving pleasure with superior fuel efficiency. And 4MATIC™ permanent all-wheel drive with

AMG-specific 40:60 Torque split combined with the AIRMATIC Adaptive Damping System guarantee a smooth ride on any road.

The interior of the ML 63 AMG is equally as impressive. AMG Illuminated stainless steel door sills greet you upon entry, visually matching to the attractive AMG sports

pedals in Brushed stainless steel with rubber studs. A beautiful *designo* leather dashboard caps off the 4.5" Colour instrument cluster display, complemented by the *designo* Velour floor mats below. It's no wonder the ML 63 AMG is as pleasing to look at as it is to drive.



The sporty and well-crafted AMG Sports steering wheel.



The AMG 5.5 L Bi-turbo V8.



Red Brake Calipers; available as part of the AMG Performance Package on the ML 63 AMG.



The ML 63 AMG interior in *designo* Nappa Leather.

Dressed for the occasion.

The finishing touches can mean the difference between a work of art and a true masterpiece. Whichever colour you opt for, you've made the right choice. Because with a selection of paint finishes benefitting from an extra scratch-resistant clear coat, your M-Class is less susceptible not only to scratches, but also to sunlight, temperature variations, dust and soot.



ARTICO ¹	Black/Black	Almond Beige/Mocha Brown	Alpaca Grey/Reef Grey	LEATHER ²	Black/Black	Tobacco Brown/Black	Almond Beige/Black	Alpaca Grey/Black	designo NAPPA LEATHER ³	Black/Black	Chestnut Brown/Black	Porcelain/Black
---------------------	-------------	--------------------------	-----------------------	----------------------	-------------	---------------------	--------------------	-------------------	------------------------------------	-------------	----------------------	-----------------

SOLID PAINT

Black	●	●	●	●	●	●	●	●	●	●	●	●
Calcite White	●	●	-	●	●	●	-	●	●	●	●	●

METALLIC PAINT

Obsidian Black	●	●	●	●	●	●	●	●	●	●	●	●
Cavansite Blue	●	●	●	●	●	●	●	●	●	●	●	●
Cinnabar Red	●	-	-	●	-	-	-	●	-	-	-	-
Tenorite Grey	●	○	●	●	●	○	●	●	●	●	●	●
Iridium Silver	●	-	●	●	●	-	●	●	●	●	●	●
Palladium Silver	●	-	●	●	●	-	●	●	●	●	●	●
Pearl Beige	●	●	-	●	-	●	-	●	-	●	-	●
Citrine Brown	●	●	-	●	-	●	-	●	-	●	-	●
Diamond White	●	●	-	●	●	●	-	●	-	●	●	●

● Recommended combination ○ Possible combination - Not available

¹Standard on the ML 350 models and standard dashboard on the ML 550 4MATIC™. ²Standard on the ML 550 4MATIC™ and available as part of an option package on all ML 350 models. ³Standard on the ML 63 AMG. Not available on all other models.

SOLID PAINT

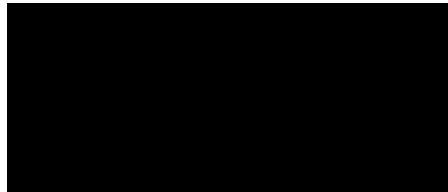

040 Black

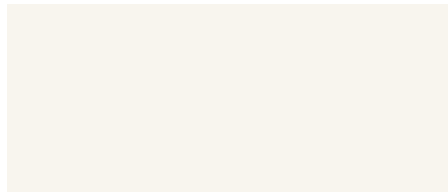

650 Calcite White

METALLIC PAINT (OPTIONAL)



151 Cinnabar Red

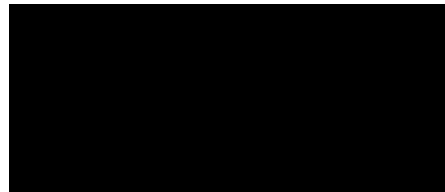

197 Obsidian Black



890 Cavansite Blue



755 Tenorite Grey



775 Iridium Silver



792 Palladium Silver



794 Pearl Beige

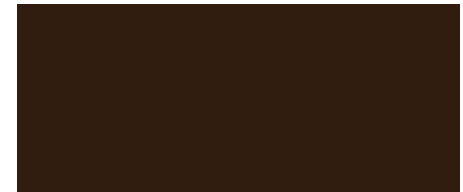

796 Citrine Brown

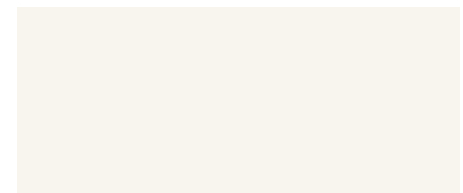

799 Diamond White

ARTICO¹



101 Black/Black



105 Almond Beige/Mocha Brown



108 Alpaca Grey/Reef Grey

LEATHER²



201 Black/Black



254 Tobacco Brown/Black



255 Almond Beige/Black



258 Alpaca Grey/Black

***designo* NAPPA LEATHER³**

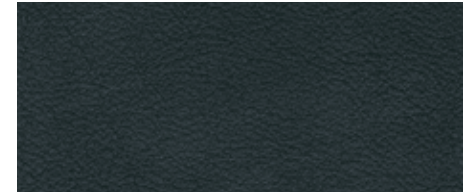

X11 Black/Black

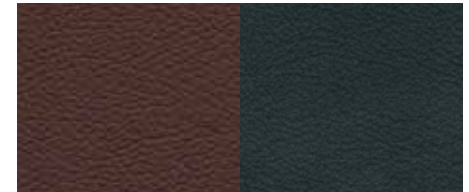

X06 Chestnut Brown/Black

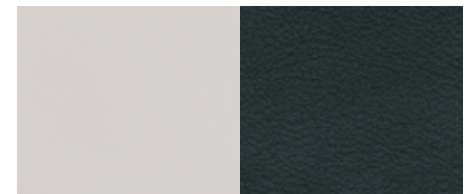

X27 Porcelain/Black

¹Standard on the ML 350 models and standard dashboard on the ML 550 4MATIC™. ²Standard on the ML 550 4MATIC™ and available as part of an option package on all ML 350 models. ³Standard on the ML 63 AMG. Not available on all other models.

TRIM



729 Anthracite Poplar Wood



H09 Brown Ash Wood (open-pore)



731 Burl Walnut Wood

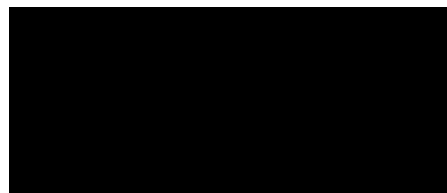

W69 *designo* Piano Black Lacquer Wood

The final touches.

Added nuances and unique refinements are just the things to make your M-Class a distinctively richer driving experience. Mercedes-Benz accessories are a cut above, having been designed and built to the highest standards for concept, engineering, quality style and function.



Load Sill Protector

Conveniently folds together to stay out of the way. When needed, roll out and protect your rear bumper from scratches and chips.



Chrome Hood Grill Inserts

Add an elegant finishing touch to the standard chrome trim elements.



Running Board Light Kit

Smart modern entrance illumination that makes getting into the vehicle at night safe and comfortable.



Door Chrome Cups

Exclusive chrome design protects against scratches and helps round out the vehicle's chrome package to perfection.

A passion for things done right.

A passion for craftsmanship and attention to detail – it's what you'd expect from Mercedes-Benz, setting us apart from all other manufacturers. It drives us to set new standards in design, performance, comfort and safety. To continually build on the legendary traditions of Mercedes-Benz, and to provide you with an ownership experience that includes the valuable benefits described below.

24-hour Roadside Assistance

During the basic warranty coverage of 48 months and the time duration of the optional Extended Limited Warranty, Mercedes-Benz Roadside Assistance will be at your service. We'll bring you some gas, replace a flat tire with your spare, or jumpstart your car. In the event of a mechanical breakdown, if attempts by our Roadside Assistance technician have not made your vehicle safely operable, towing service will be provided to the nearest Mercedes-Benz dealership. Assistance is available 24 hours a day, every day, to anyone driving a Mercedes-Benz anywhere in Canada or the continental U.S.¹

Wear and tear period

The following parts listed are covered for wear and tear during the first 24 months or 40,000 km, whichever comes first. Brake pads, brake discs, brake pad wear sensors and light bulbs.

Mercedes-Benz warranties

The Mercedes-Benz New Vehicle Limited Warranty covers defects in materials or workmanship for 48 months or 80,000 km, whichever comes first. To widen your window of confidence, you can opt for a Mercedes-Benz Extended Limited Warranty as well.²

Customer service

Owning a Mercedes-Benz means that when you have a question, we're here to help. Customer Service is open from 9 a.m. to 5 p.m. EST, Monday through Friday, and is staffed with knowledgeable Mercedes-Benz experts who can talk you through the finer points of working your car's audio system – or even assist you in locating the nearest Mercedes-Benz dealership. Just call 1-800-387-0100. It's that simple.

Trip interruption reimbursement

If a breakdown covered by your New Vehicle Limited Warranty or optional

Extended Limited Warranty occurs more than 80 km from your home, leaves your Mercedes-Benz vehicle inoperable or unsafe to drive, and requires overnight repairs, we've got you covered. You will be reimbursed up to \$500 for hotel accommodations and up to \$600 for alternative travel expenses per incident while your car is being repaired at an authorized Mercedes-Benz dealership.

¹Vehicle must be accessible from main roads. Roadside Assistance may involve charges for parts, service and towing. Depending on the circumstances, these services may be provided by an outside service provider, courtesy of Mercedes-Benz Roadside Assistance. For full details of the Roadside Assistance Program, please see your dealer. ²Please see your dealer for warranty details as well as for terms, conditions and pricing for extended warranty options.



Mercedes-Benz is virtually yours.

Visit mercedes-benz.ca and open an online window to Mercedes-Benz Canada. Revel in the incredible photography of our vehicles and get a visceral impression of what it would be like to see yourself behind the wheel. Access information about any of our vehicles, including financing and leasing options, upcoming models, and configure your dream Mercedes online. Our website also offers details about the Mercedes-Benz Extended Limited Warranty, vehicle ownership, and much more on the fascinating story behind one of the world's most recognizable brands.

To be continued. With a test drive.

Nowhere is your M-Class so convincing as on the road. It's only there that you can fully experience the superior handling and power that makes this car so special. Feel the engine move you forward, and watch your heart rate rise with the speedometer. That unique feeling in your stomach cannot be put down on paper. That's why we would like to invite you in for a test drive at your local Mercedes-Benz dealer. Reserve your appointment today, or visit mercedes-benz.ca. We look forward to seeing you.

The 2013 M-Class

EQUIPMENT LISTING AND TECHNICAL SPECIFICATIONS

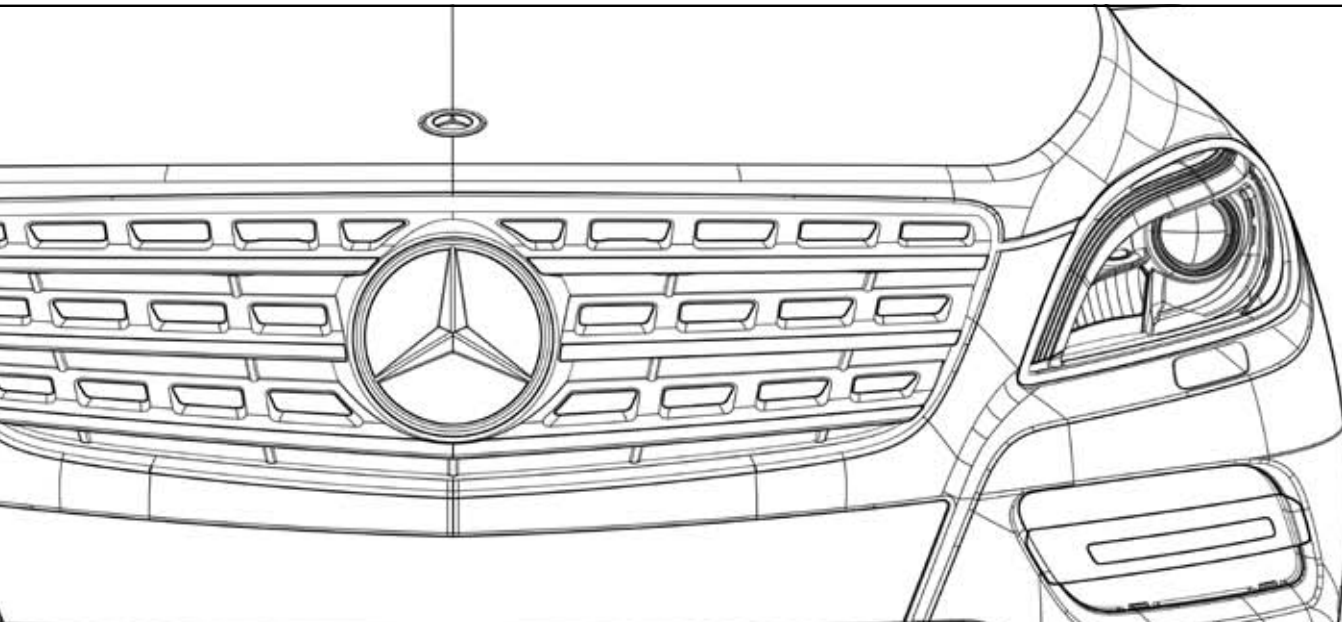

Mercedes-Benz

The best or nothing.

INDIVIDUAL EQUIPMENT

TRANSMISSION

7G-TRONIC automatic transmission

AMG SPEEDSHIFT PLUS 7G-TRONIC

TRACTION/STABILITY

4MATIC™ permanent all-wheel drive with 4ETS

4MATIC™ permanent all-wheel drive with AMG-specific 40:60 Torque Split

Electronic stability program (ESP®) including ABS and traction control

Brake Assist (BAS)

AIRMATIC air suspension with Adaptive Damping System (ADS)

Downhill Speed Regulation (DSR)

AUDIO/VISUAL/COMMUNICATION

COMAND without navigation & DVD changer

COMAND APS with HDD navigation & DVD changer

harman/kardon® LOGIC7® surround sound system

BANG & OLUFSEN performance surround sound system

SIRIUS Satellite Radio¹

Rear Seat Entertainment System

Bluetooth connectivity

Media interface

EXTERIOR

19" 5 twin-spoke wheels

20" AMG 5-spoke wheels

21" AMG 5 twin-spoke wheels

21" AMG 5 twin-spoke wheels (Code 798)

AMG styling package

Exterior power folding mirrors

Auto dimming mirrors (rear view & driver's side)

Heated windshield washer system

ML 350 4MATIC™	ML 350 BlueTEC 4MATIC™	ML 550 4MATIC™	ML 63 AMG
▲	▲	▲	–
–	–	–	▲
▲	▲	▲	–
–	–	–	▲
▲	▲	▲	▲
▲	▲	▲	▲
○	○	▲	▲
▲	▲	▲	▲
▲	▲	–	–
○	○	▲	▲
○	○	○	▲
–	–	Δ	Δ
▲	▲	▲	▲
Δ	Δ	Δ	Δ
▲	▲	▲	▲
○	○	▲	▲
▲	▲	–	–
○	○	▲	–
–	–	Δ	–
▲	▲	▲	▲
▲	▲	▲	▲
▲	▲	▲	▲
▲	▲	▲	▲
▲	▲	▲	▲

INDIVIDUAL EQUIPMENT

EXTERIOR

Active Bi-Xenon headlamps

Adaptive Highbeam Assist (AHA)

Headlamp washers

Aluminium running boards

Trailer hitch

INTERIOR

Climate comfort front seats

Multicontour front seats with massage

Power adjustable front seats

Power lumbar support

Memory package with power steering column

Wood/leather steering wheel

designo wood/leather steering wheel

Heated front seats

Heated leather covered steering wheel with telescopic steering adjustment

THERMATIC automatic climate control

Illuminated visor vanity mirrors

Sliding glass sunroof with pop-up

Panoramic sunroof

Heated rear seats

Privacy glass

Ambient lighting with 3 colour settings

CONVENIENCE

Integrated garage door opener

KEYLESS-GO

Rear view camera

SmartKey with panic button

EASY-PACK power tailgate

EASY-PACK load securing kit

115V power socket

ML 350 4MATIC™	ML 350 BlueTEC 4MATIC™	ML 550 4MATIC™	ML 63 AMG
○	○	▲	▲
○	○	▲	▲
○	○	▲	▲
Δ	Δ	Δ	Δ
Δ	Δ	Δ	–
Δ	Δ	○	○
Δ	Δ	Δ	Δ
▲	▲	▲	▲
▲	▲	▲	▲
▲	▲	▲	▲
▲	▲	▲	▲
Δ	Δ	Δ	Δ
–	–	Δ	–
▲	▲	▲	▲
▲	▲	▲	▲
▲	▲	▲	▲
▲	▲	▲	▲
▲	▲	▲	▲
▲	▲	▲	▲
○	○	○	○
○	○	○	○
▲	▲	▲	▲
▲	▲	▲	▲
○	○	○	○
○	○	○	○
Δ	Δ	○	○
Δ	Δ	○	○

INDIVIDUAL EQUIPMENT

SAFETY

Dual stage front airbags, front side airbags, front pelvic airbags, driver's knee airbag, head protection curtain airbags and rear side airbags
Seatbelts with belt force limiters and emergency tensioning device (ETD)
COLLISION PREVENTION ASSIST
ATTENTION ASSIST
PRE-SAFE®
DISTRONIC PLUS
PARKTRONIC with Active Parking Assist
Anti-theft alarm system
Active Blind Spot Assist
Passive Blind Spot Assist
Active Lane Keeping Assist
Passive Lane Keeping Assist
Tire Pressure Loss Warning System
Electric parking brake

ML 350 4MATIC™	ML 350 BlueTEC 4MATIC™	ML 550 4MATIC™	ML 63 AMG
▲	▲	▲	▲
▲	▲	▲	▲
▲	▲	▲	▲
▲	▲	▲	▲
▲	▲	▲	▲
○	○	○	○
○	○	▲	▲
▲	▲	▲	▲
○	○	○	○
○	○	○	▲
○	○	○	○
▲	▲	▲	▲
▲	▲	▲	▲

EQUIPMENT PACKAGES

ML 350 PREMIUM PACKAGE: Rear view camera, Panoramic sunroof, PARKTRONIC with Active Parking Assist, Heated rear seats, KEYLESS-GO, EASY-PACK power tailgate, Media interface, COMAND APS with HDD navigation & DVD changer, harman/kardon® LOGIC7® surround sound system.

ML 350 SPORT PACKAGE: Adaptive damping system (ADS), AIRMATIC air suspension, 20" AMG 5-spoke wheels.

ML 550 4MATIC™ PREMIUM PACKAGE: Rear view camera, Climate comfort front seats, Heated rear seats, harman/kardon® LOGIC7® surround sound system, KEYLESS-GO, EASY-PACK power tailgate, 115V Power socket.

ML 63 AMG PREMIUM PACKAGE: Rear view camera, Climate comfort front seats, Heated rear seats, KEYLESS-GO, EASY-PACK power tailgate, 115V Power socket.

AMG PERFORMANCE PACKAGE: Additional horsepower (32 additional hp; 44 lb-ft of additional torque), Electronic speed limiter deletion², AMG Performance steering wheel, Red brake calipers.

LEATHER PACKAGE: Leather upholstery, ARTICO leather dashboard.

ADVANCED DRIVING ASSISTANCE PACKAGE: DISTRONIC PLUS, Active Blind Spot Assist, Active Lane Keeping Assist.

DRIVING ASSISTANCE PACKAGE: Passive Blind Spot Assist, Passive Lane Keeping Assist.

BI-XENON HEADLAMP PACKAGE: Headlamp washers, Adaptive highbeam assist (AHA), Active Bi-Xenon headlamps.

ML 350 4MATIC™	ML 350 BlueTEC 4MATIC™	ML 550 4MATIC™	ML 63 AMG
Δ	Δ	-	-
Δ	Δ	-	-
-	-	Δ	-
-	-	-	Δ
-	-	-	Δ
Δ	Δ	-	-
Δ	Δ	Δ	Δ
Δ	Δ	Δ	-
Δ	Δ	-	-

▲ Standard equipment Δ Optional Equipment ○ Optional as part of a Package - Not available

¹Complimentary service is comprised of a SIRIUS package for a duration of 6 months. Monthly subscription required for service thereafter.
 © 2012 Sirius XM Canada Inc. "SiriusXM", the SiriusXM logo, channel names and logos are trademarks of Sirius XM Radio Inc. and are used under licence. ²Intended for track use. Please obey all speed laws.

Technical data:

	ML 350 BlueTEC 4MATIC™	ML 350 4MATIC™	ML 550 4MATIC™	ML 63 AMG
Engine type	24V DOHC V6	24V DOHC V6	32V DOHC V8	32V DOHC V8
Total displacement	2,987 cm ³	3,498 cm ³	4,663 cm ³	5,461 cm ³
Net power	240 hp @ 3,600 rpm	302 hp @ 6,500 rpm	402 hp @ 5,000 – 5,750 rpm	518 hp @ 5,250 – 5,750 rpm
Net torque	455 lb-ft @ 1,600-2,400 rpm	273 lb-ft @ 3,500-5,250 rpm	443 lb-ft @ 1,600-4,750 rpm	516 lb-ft @ 1,750-5,000 rpm
Acceleration ¹ , 0–100 km/h	7.4 seconds	7.6 seconds	5.4 seconds	4.8 seconds
Approximate top speed ²	210 km/h	210 km/h	210 km/h	250 km/h
Tires, front rear	255/50 R 19 255/50 R 19	255/50 R 19 255/50 R 19	265/45 R 20 265/45 R 20	295/35 R 21 295/35 R 21
Fuel economy ³ , city/highway estimate	10.5-7.3 L/100 km	12.3 – 8.9 L/100 km	14.5 - 10.0 L/100 km	15.6 - 11.5 L/100 km
Fuel tank capacity	93 litres	93 litres	93 litres	93 litres
Fuel requirement	Diesel	Premium unleaded	Premium unleaded	Premium unleaded
Dimensions ⁴				
Wheelbase	2,915 mm	2,915 mm	2,915 mm	2,915 mm
Overall length	4,804 mm	4,804 mm	4,804 mm	4,817 mm
Overall height	1,796 mm	1,796 mm	1,796 mm	1,796 mm
Overall width – Mirrors Extended	2,141 mm	2,141 mm	2,141 mm	2,141 mm
Curb weight	2,175 kg	2,130 kg	2,288 kg	2,345 kg
Cargo capacity	690 – 2,010 litres	690 – 2,010 litres	690 – 2,010 litres	690 – 2,010 litres

¹Stated rates of acceleration are based on the manufacturer's track results and may vary depending upon model, environmental and road surface conditions, driving style, elevation and vehicle load. ²Electronically limited.

³These estimates are based on Government of Canada testing methods. The actual fuel consumption of these vehicles may vary. Refer to the Government of Canada Fuel Consumption Guide ⁴With standard equipment.

© 2012 Mercedes-Benz Canada Inc.

All illustrations and specifications contained in this brochure are based on the latest product information available at the time of publication. Mercedes-Benz Canada reserves the right to make changes at any time, without notice, in colours, materials, equipment, specifications and models. Any inaccuracies in colours shown are due to reproduction variations of the printing process. Some vehicles may be shown with non-Canadian equipment. Some vehicles may be shown without side marker lights. Some vehicles are shown with optional equipment available at extra cost. Some optional equipment may not be available on all models. For current information regarding the range of models, standard features, optional equipment and/or colours available in Canada and their pricing, contact your nearest authorized Mercedes-Benz dealer or visit mercedes-benz.ca. harman/kardon® and LOGIC7® are registered trademarks of Harman International Industries Inc. iPod® is a registered trademark of Apple Computer, Inc.

Printed in Canada
MBC-12-M13-20075E

Mercedes-Benz Canada Inc. 98 Vanderhoof Avenue, Toronto, Ontario M4G 4C9
1-800-387-0100
mercedes-benz.ca

