

# LEGACY 2005



[www.subaru.ca](http://www.subaru.ca)



The Supplemental Restraint System (SRS airbags) affords the driver and passenger additional protection in some collisions. This system provides supplemental protection only, and seatbelts must be worn in order to avoid injuries to out-of-position occupants upon airbag deployment. The combination of SRS and seatbelts provides the best protection in a serious accident. All illustrations, specifications, features and photographs contained in this brochure are based on product information available at the time of its printing, and may not be completely accurate following its publication. Colours shown may vary due to reproduction variations in the printing process, and some vehicle parts cannot be shown in certain photographs. Subaru Canada Inc. reserves the right to discontinue or make changes at any time, without notice or incurring obligations, to colours, materials, equipment, accessories, features, specifications and models, or to change their prices. Some models shown may be from international markets and are not available in Canada, or they may be shown with equipment or accessories which are optional (at extra cost) or only available in certain combinations, or they may be subject to product delays or not be available in Canada. Please visit our Web site for the latest information and specifications. For complete details on product updates, warranties or the Subaru Care program, please contact your Subaru Dealer. Subaru, Legacy, SUBARU BOXER, Subaru CARE and Subaru CARE Customer Assistance for Roadside Emergencies are registered trademarks. SPORTSHIFT is a registered trademark of Prodrive. Printed in Canada. 2004 Subaru Canada, Inc. 2005 Legacy model year.



SBL05E

Think. Feel. Drive.

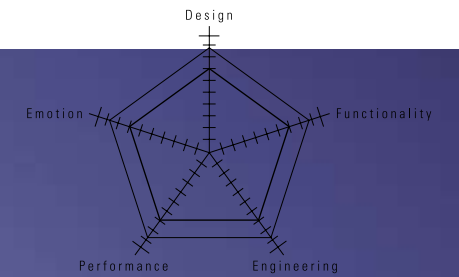

## The Perfect Balance

### Subaru Symmetrical AWD

Whether in the design of a skyscraper or the formation of a snowflake, symmetry creates balance. The Subaru symmetrical full-time All-Wheel Drive system was designed and engineered to achieve the pinnacle of automotive balance, providing unequalled safety and performance through a simple, linear drivetrain configuration. The horizontally-opposed engine, All-Wheel Drive transmission and sophisticated suspension work in complete harmony with the all-new 2005 Legacy's redesigned, lightweight yet incredibly rigid body structure to provide an absolutely world-class driving experience.



**SYMMETRICAL AWD**





***Advanced technology for  
an increasingly challenging world.***

*From modern, multi-lane highways to winding mountain switchbacks, the environment in which we drive is becoming increasingly challenging. That is why the all-new 2005 Legacy – and every vehicle Subaru builds – is designed and engineered with three simple words in mind:*

*Think. Feel. Drive.*

*Every Subaru is the product of intelligent design, forward thinking and over 30 years of All-Wheel Drive expertise.*

*Every Subaru is created with the feeling and passion our engineers have for the act of driving and for translating cutting-edge ideas into real-world technology.*

*Every Subaru is built to be driven and appreciated from both a practical standpoint and an emotional one.*

*By combining these three simple, yet integral concepts with the lessons we have learned in the heat of World Rally Championship (WRC) competition, we have created a vehicle built from the ground up to handle virtually any challenge while providing exhilarating performance and exceptional sophistication: the 2005 Legacy.*

**SYMMETRICAL AWD**



*- Petter Solberg & Phil Mills -  
2003 FIA World Rally Championship for Drivers & Co-Drivers*



**Legacy.**  
Simply world-class.

It takes world-class technology and design to produce a world-class driving experience. With that in mind, Subaru is proud to present the completely redesigned and totally re-engineered 2005 Legacy. Featuring sophisticated weight reduction technology, a state-of-the-art All-Wheel Drive system and all-new levels of style and power, the Legacy provides driving enthusiasts with an exhilarating blend of performance, refinement and safety. Designed to appeal to your senses and engineered to excite your driving spirit, the Legacy represents the next step in the evolution of the grand touring sedan and wagon.







**Built for the  
driving enthusiast.**

When the traffic clears and the road opens up, the 2005 Legacy truly shines. With the proven traction and control of Subaru symmetrical full-time All-Wheel Drive, an incredibly stiff yet lightweight chassis, sophisticated suspension and a near telepathic link between driver and vehicle, the aerodynamically refined Legacy was purpose-built for the discerning driving enthusiast. The Legacy is also available with a soul-stirring, turbocharged SUBARU BOXER engine capable of blurring the outside world with a blazingly quick 5.8 second\* run from 0-to-60 mph.

\*0-60 mph acceleration time for Legacy 2.5GT (5MT), based on testing done by Subaru.



## Dynamic by design.

While advanced technology and superb performance are integral aspects of the 2005 Legacy, these attributes don't come at the expense of style. With its clean, aerodynamic lines, striking front fascia, athletic stance, distinctive headlights and sleek profile, the Legacy communicates

sophistication from every angle and evokes an intense passion for the open road. Offering a world-class driving experience bolstered by intelligent design and superior engineering, the Legacy excites the senses and creates an emotional bond with each and every driver.



2.5i Sedan



2.5i Limited Sedan

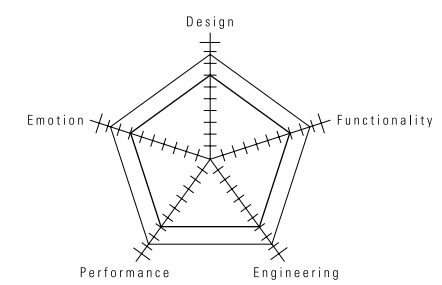



Comforting thoughts.



You'll experience feelings of inspiration and of everything being proportioned just right the first time you slip behind the wheel of the 2005 Legacy. With a sleek, inspiring design, sophisticated technology and the soul of a rally champion, you'll feel at one with the Legacy and be able to

identify with the image it projects. Look a little deeper and you'll find reassurance in the build quality, world-class safety and performance that are synonymous with the Subaru name. Each and every detail contributes to your complete satisfaction. Your seat is waiting for you.

**The freedom of  
comfort and security.**

With its reassuring, solid feel; incredibly smooth, refined ride and luxuriously appointed, inviting cabin, the 2005 Legacy was designed with your total comfort in mind. However, beyond its world-class build quality and sophisticated design, the Legacy also includes a wide array of state-of-the-art safety features that combine to inspire a strong sense of security. When you are ready for an escape, the Legacy gives you the confidence and freedom to do so with feelings of complete contentment and peace of mind.





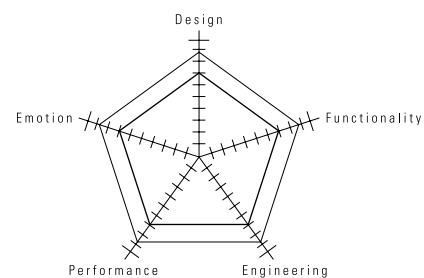

2.5i Wagon



2.5GT Wagon

**One vehicle for work and play.**

With a spacious, well-thought-out cabin, an intelligently designed cargo area and truly refined driving dynamics, the stylish all-new 2005 Legacy is a perfect workday companion. With an available turbocharged engine pumping out an incredible 250 hp and 250 lb-ft of torque

and the same core All-Wheel Drive technology as Subaru's championship-winning WRC rally cars, the Legacy is also a perfect tool for spirited driving. Whether you're tackling the morning commute or a winding mountain switchback, the Legacy is simply world-class.



The next step in  
the evolution of driving.

The introduction of the all-new 2005 Legacy represents the next step in the evolution of the grand touring sedan and wagon. By combining state-of-the-art technology, outstanding craftsmanship, unparalleled safety and awe-inspiring performance with a stunning, versatile and intelligently designed package, we have redefined what a Subaru can be. By designing the Legacy around the rally-proven Subaru symmetrical full-time AWD system, we made sure it retained the soul of a champion. To experience how world-class technology and design can produce a world-class driving experience, test drive the Legacy 2.5i or the turbocharged 2.5GT today.





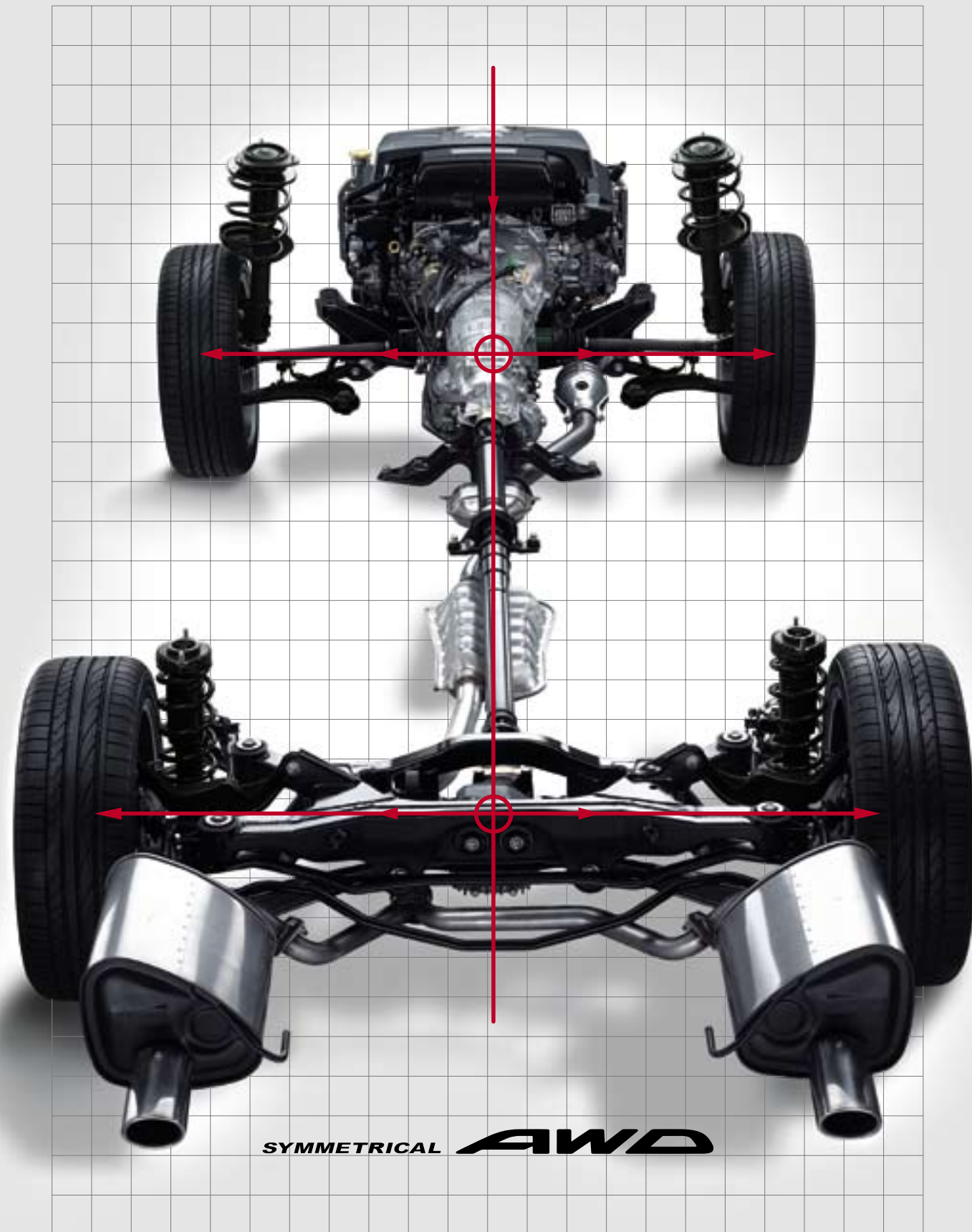

# SYMMETRICAL AWD

The benefits of the Subaru symmetrical full-time All-Wheel Drive system are recognized the world over.

## The superiority of Subaru AWD.

The symmetrical full-time All-Wheel Drive system, standard in every Subaru built for the Canadian market, is much more than the sum of its parts. It is the result of over 30 years of research and development. It is the product of rigorous testing in the heat of World Rally Championship (WRC) competition. It is the culmination of one company's unique quest to provide unparalleled safety and performance in all of its vehicles, regardless of road or weather conditions. Quite simply, it is our passion.

In contrast to conventional designs, Subaru strategically positions the engine, transmission and transfer case along the centreline of the vehicle to create an exceptionally balanced drivetrain. This simple layout provides superior handling and control while increasing driveline efficiency. In the end, the 2005 Legacy's unique symmetrical full-time All-Wheel Drive system, including a limited-slip rear differential on 2.5GT models, provides exceptional levels of both performance and safety, translating into added driver confidence and enjoyment in virtually any weather or road condition.

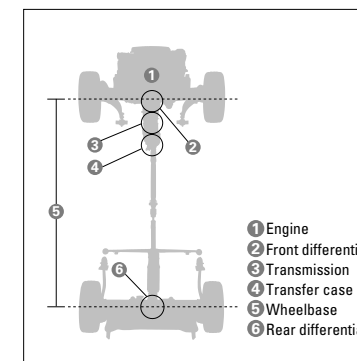

## SUBARU BOXER



The higher the centre of gravity of a vehicle, the greater the compromise to the vehicle's handling and stability. That is why the 2005 Legacy uses a horizontally-opposed "boxer" engine, with pistons that move horizontally, rather than vertically – like a boxer throwing an endless combination of perfect rights and lefts. Unlike the bulky size of some V-shaped or in-line configuration engines, the compact design of the SUBARU BOXER allows it to be mounted closer to the road and in harmony with the symmetrical layout of the drivetrain, lowering the Legacy's centre of gravity and improving its balance. Also, all SUBARU BOXER engines are aluminum units whose low mass further contributes to solid handling and directional stability. With the natural smoothness, efficiency and responsiveness of its powerplant and the performance of symmetrical full-time AWD, the Legacy offers a world-class driving experience.



# DRIVE SUBARU



## Push the envelope.

At Subaru, we believe advanced technology and innovative design can provide an ideal balance between world-class safety and performance, inspiring driver confidence and a passion for the open road. As proof of these beliefs, Subaru is proud to present the all-new 2005 Legacy. By combining a lightweight yet incredibly rigid chassis with the compact size and responsiveness of a SUBARU BOXER engine, the control and traction of symmetrical full-time AWD and the all-road benefits of long-travel suspension, the Legacy offers superior vehicle dynamics as well as exceptional stability and grip. Whether tackling a winding mountain road on a clear autumn day or performing an emergency lane change in the dead of winter, the Legacy has been designed and engineered from the ground up to create seamless communication between vehicle and driver,



providing both exhilaration and peace of mind.

## Advantages of Subaru symmetrical full-time AWD and the SUBARU BOXER engine.

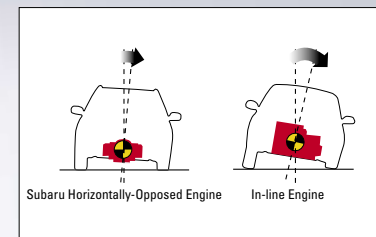

### Better balance

During cornering, centrifugal force causes a vehicle to lean; how much it leans depends in part on the position of the vehicle's centre of gravity. Due to the placement of the compact, aluminum, horizontally-opposed SUBARU BOXER engine, the all-new 2005 Legacy features an exceptionally low centre of gravity, which helps improve handling and stability while reducing body roll and deviation from your chosen direction.

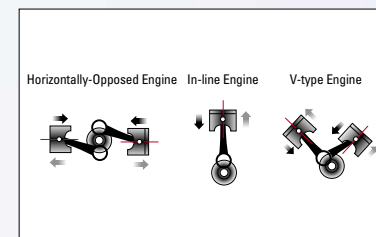

### Less vibration

With its 180-degree configuration, Subaru's horizontally-opposed engine dramatically cuts down vibration by eliminating the inertia of opposing pistons that exists in some V-shaped or in-line configuration engines. The result with the SUBARU BOXER engine is smooth, seamless power right through the rev range as well as unprecedented driving comfort.

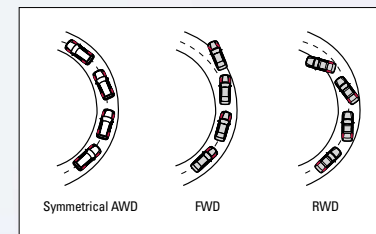

### More grip and traction

One reason that Subaru has devoted so much time and energy to perfecting full-time AWD is the system's inherent advantages over two-wheel drive during cornering. By transmitting power through all four tires, the Legacy is better able to maintain its intended path, allowing for stable and controlled cornering. In contrast, when gripping ability is restricted to just two tires in front-wheel drive (FWD) or rear-wheel drive (RWD) vehicles, lateral forces tend to make the vehicle either "understeer" or "oversteer", which can lead to instability.



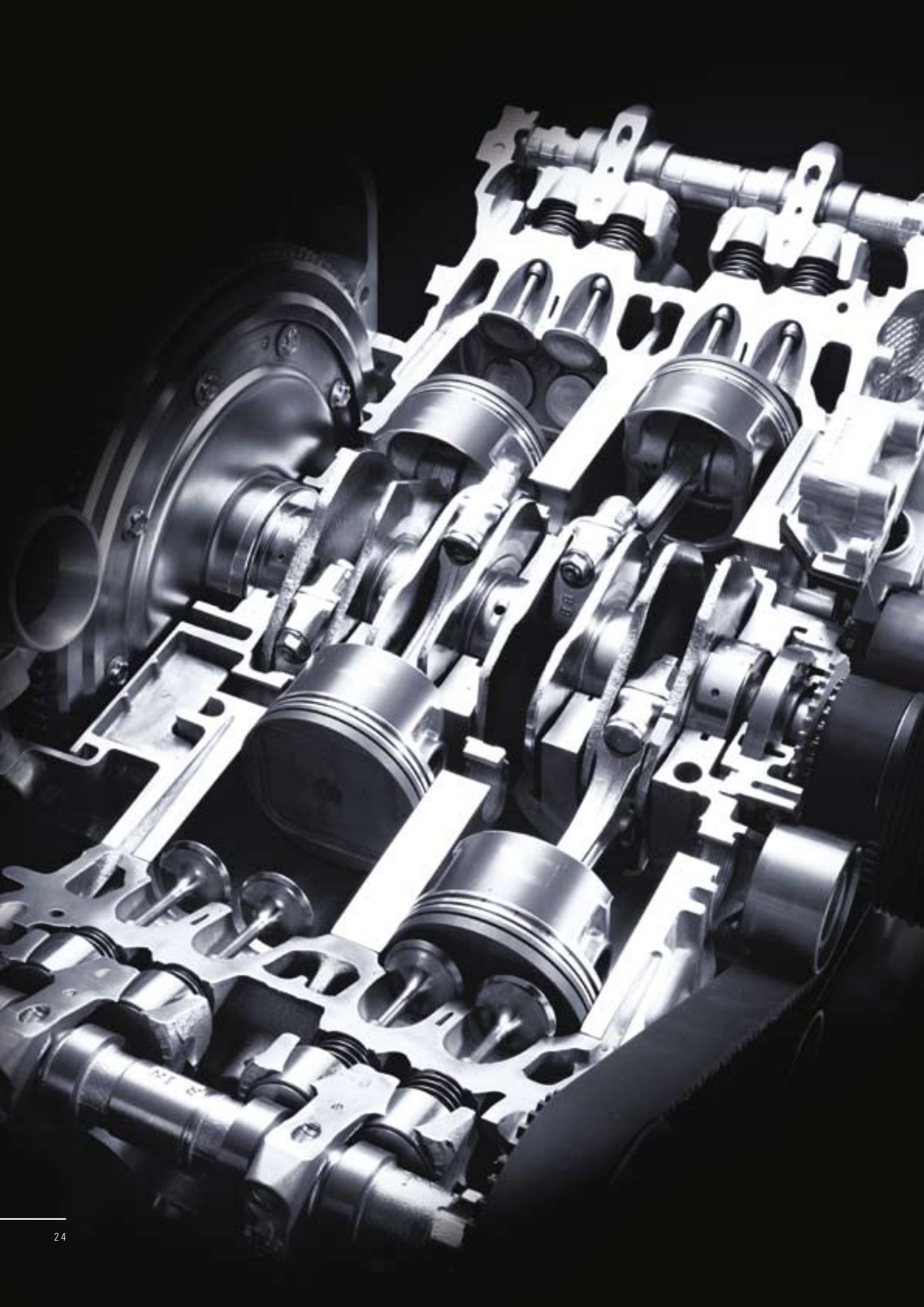

# the POWER

## ADVANCED ENGINE TECHNOLOGIES

*Just like the engine in the mighty World Rally Championship (WRC) Impreza WRC2004, all Subaru vehicles sold in Canada are equipped with aluminum, horizontally-opposed SUBARU BOXER engines. This is because SUBARU BOXER engines are lightweight, compact and positioned to create a low centre of gravity. These attributes, along with the engine's responsiveness, efficiency and natural smoothness, help to make the SUBARU BOXER the ideal focal point of the Subaru symmetrical full-time All-Wheel Drive system. Whether you choose the 2.5 litre naturally aspirated version or the 2.5 litre turbocharged version, both Legacy engines offer a responsible balance between performance and efficiency.*

### New performance exhausts

All 2005 Legacy models benefit from a sophisticated new performance exhaust system that helps to reduce exhaust resistance and engine noise while increasing torque. Combined with twin, ultra-low-back-pressure mufflers, the new exhaust system also provides a performance-oriented variation of the classic Subaru sound.



Exhaust manifold

### New engine technologies

When an engine gets hot, the aluminum cylinder block and the steel crankshaft expand at different rates, leading to unwanted noise and vibration. To address this phenomenon, Subaru engineers developed a process in which a high-strength steel alloy is cast into the aluminum cylinder block. This process helps to lessen the expansion differential, resulting in a smoother and quieter engine.



Steel casted journal

### 2.5 litre turbo engine

Pumping out 250 hp and 250 lb-ft of torque, the 2.5 litre, turbocharged and intercooled SUBARU BOXER engine features an Active Valve Control System (AVCS) to produce the tremendous low-end torque, strong top-end performance and quiet, smooth idle expected of a true grand touring vehicle. With drive-by-wire Electronic Throttle Control (ETC) technology providing immediate throttle control and improved engine response, the Legacy 2.5GT's SUBARU BOXER is a lightweight, dual overhead cam (DOHC) unit that offers exhilarating, silky-smooth power delivery. With hollow camshafts and a revised cylinder design to increase performance and the natural smoothness and responsiveness of all SUBARU BOXER engines, the engine powering the Legacy 2.5GT is a technological tour de force.



### 2.5 litre engine

The 2.5 litre single overhead cam (SOHC) naturally aspirated SUBARU BOXER engine that powers Legacy 2.5i models is both free-revving and fuel efficient and features drive-by-wire Electronic Throttle Control (ETC) technology for immediate throttle control, improved engine response and superior feel. With its compact dimensions and light weight, the 2.5 litre, horizontally-opposed SUBARU BOXER provides outstanding balance and directional stability while producing a broad torque curve for impressive performance. Producing a healthy 168 hp and 166 lb-ft of torque, the 2.5 litre engine achieves outstanding fuel economy and impeccable reliability.







# the SHIFT

## TRANSMISSION TECHNOLOGIES

*Designed to take full advantage of the inherent virtues of Subaru full-time AWD and the symmetrical layout of the drivetrain, the transmissions in the 2005 Legacy lineup are a marvel of engineering and efficiency. Created to bring smooth, vibration-free gear changes and an exceptional level of driver control, the Legacy's transmissions are also cleverly packaged – as opposed to other vehicles featuring complex differentials and torque split systems. By combining the transmission, front differential and transfer case into a single unit that is mounted symmetrically along the centreline of the vehicle, Subaru engineers created a transmission that is not only compact, but also fuel efficient. Capable of delivering linear, controllable, full-time power to all four wheels in virtually any driving condition, the Legacy's manual and automatic transmissions offer a superb balance of precise, smooth performance and engineered efficiency.*

### **Electronically controlled 4-speed Automatic Transmission (4EAT SS)**

The Legacy's advanced, electronically controlled 4-speed automatic with SPORTSHIFT™ features a gated gear selector and smooth, seamless gearshifts. Working in combination with the latest-generation, electronically controlled



multi-plate transfer clutch, the 4-speed automatic optional on the Legacy 2.5i and standard on the Legacy 2.5i Limited can intelligently distribute power between front and rear wheels to provide superior traction and control. Besides featuring direct shift control, which results in smoother gear changes, increased efficiency and response, the 4-speed automatic also boasts SPORTSHIFT™, a manual mode which allows the driver to control gear shifts for maximum driving enjoyment and control.

### **Electronically controlled 5-speed Automatic Transmission (5EAT SS)**

The Legacy 2.5GT's optional transmission is a sophisticated 5-speed automatic with direct shift control and SPORTSHIFT™. Through the operation of controls on the MOMO steering wheel or within the gated gear selector,



SPORTSHIFT™ allows driver control over gear changes for sporty, involved operation. When left in automatic mode, the driver can adjust the shift pattern between Normal – which provides outstanding fuel efficiency and smooth operation – and Sport – which delays upshifts for increased performance. Whether controlled by the driver or left in automatic mode, the 5-speed automatic features Variable Torque Distribution (VTD) All-Wheel Drive with lateral g-sensor and an electronically controlled locking centre differential for increased performance and vehicle stability.

### **5-speed Manual Transmission (5MT)**

The 5-speed manual transmission that comes standard in Legacy 2.5i and 2.5GT models is designed and engineered to integrate perfectly into the Legacy's symmetrical full-time All-Wheel Drive system. Using sophisticated



Computer-Aided Design (CAD) technology, Subaru engineers were able to decrease the 5-speed manual's overall weight while increasing shift feel, responsiveness and driveline efficiency, resulting in a manual transmission that is a joy to work through the gears. With a compact, viscous-coupling limited-slip centre differential providing intelligent torque distribution, the 5-speed manual offers precise control, exceptional efficiency and superior All-Wheel Drive traction and performance.



# the DRIVABILITY

## SUSPENSION TECHNOLOGIES

*The balanced, symmetrical layout of the 2005 Legacy's drivetrain provides a perfect foundation for 4-wheel independent suspension. Thanks to the compact size and the centrally mounted location of the SUBARU BOXER engine between the front struts, the Legacy utilizes long, equal-length axle shafts. These help to maximize suspension travel at all four wheels, virtually eliminating "torque steer", which occurs when a vehicle pulls to one side under brisk acceleration. Beyond the inherent balance offered by equal-length front and rear axle shafts, the Legacy's sophisticated suspension works in unison with its state-of-the-art chassis to provide complete stability and responsive handling.*

### Suspension

Even the best All-Wheel Drive system in the world becomes ineffective if the tires are not making contact with the road. To ensure the utmost in safety and control, the 2005 Legacy uses long-travel suspension as a part of the Subaru symmetrical full-time AWD system. Due to its highly tuned long-travel suspension and incredibly rigid chassis, the Legacy is better able to maintain tire contact with the road, even over uneven surfaces. The Legacy also features anti-dive front suspension and a re-engineered multi-link anti-squat rear suspension designed to offer greater resistance to body roll when cornering while minimizing forward dive under hard braking and rearward squat under hard acceleration.



### Lightweight components

While its sophisticated suspension helps to give the 2005 Legacy impressive handling and responsiveness, state-of-the-art weight reduction technology is also integral to the Legacy's dynamic capabilities. Subaru engineers went to great lengths to decrease the Legacy's weight to achieve higher levels of performance while also improving fuel economy, vehicle emissions and safety. Through the increased use of aluminum, high-tensile steel and new production methods such as tailor-blanked welding and hydro-forming, the 2005 Legacy's frame is not only lighter, which improves overall performance and braking capabilities, but substantially stronger, providing superior protection during a collision.

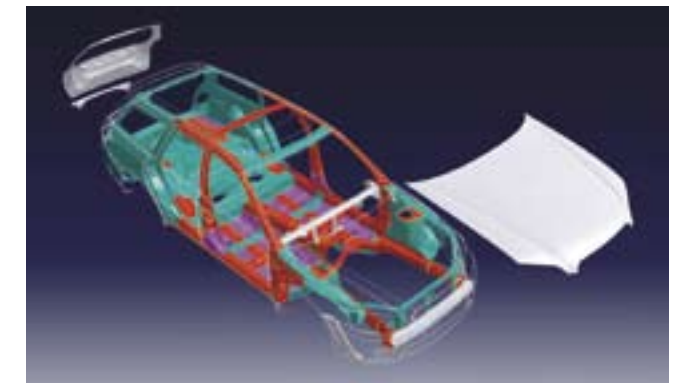

Material Comparison	Percentage
Steel	46.5%
Aluminum	4.5%
High-tensile strength steel and tailored-blank	14.2%
High-tensile strength steel	34.8%



# the ACTIVE safety

ACTIVE SAFETY TECHNOLOGIES

## Safety starts with symmetrical full-time All-Wheel Drive

At Subaru, we believe a truly safe vehicle is one that excels at preventing accidents before they happen. With that in mind, the 2005 Legacy was designed from the ground up to offer best-in-class active safety features in an effort to inspire driver confidence and peace of mind. Active safety begins with the Subaru symmetrical full-time All-Wheel Drive system, which offers sure-footed traction and control in a variety of weather and road conditions. From snow-covered back roads to rain-slicked highways, Legacy drivers feel confident knowing that power can be directed to where it is needed most in virtually any situation. The Subaru symmetrical full-time All-Wheel Drive system also provides the Legacy with the rock-solid stability to confidently carve through winding roads or sharp corners and maintain its composure over rougher terrain. Because the Legacy's All-Wheel Drive system is full-time, its benefits can be appreciated throughout every journey – even on dry, pristine roads.

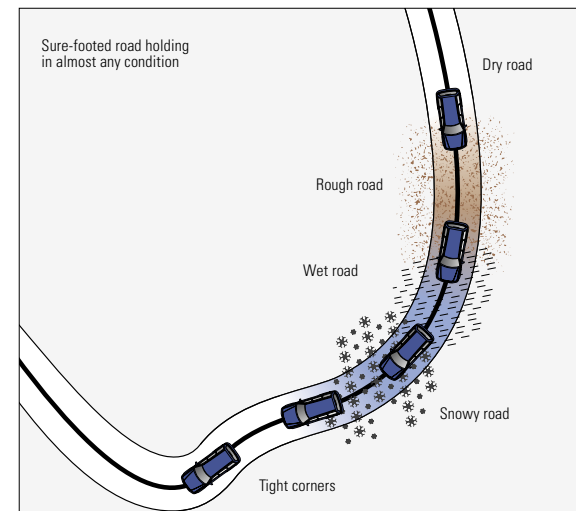

## ABS braking

In addition to the active safety benefits of the Subaru symmetrical full-time All-Wheel Drive system and the vehicle's reduction in weight, a 4-wheel/4-channel/4-sensor

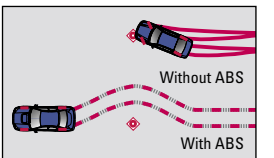

Anti-Lock Braking System (ABS) is also standard on all 2005 Legacy models. Working through sensors at all four wheels, ABS prevents wheels from locking up during heavy braking, allowing the driver to apply the brakes and steer away from trouble at the same time. ABS provides outstanding safety



Front ventilated disc brake



Rear disc brake

and control, even during emergency manoeuvres or in inclement weather conditions. All Legacy models are also equipped with Electronic Brake-Force Distribution (EBD), which detects passenger and cargo load and then controls the balance between front and rear brakes to help maintain a consistent stopping distance, even when the vehicle is weighed down.



# the **PASSIVE** safety

PASSIVE SAFETY TECHNOLOGIES



 : New advanced ring-shaped reinforcement frame

## Airbags, seatbelts and passive safety head restraints

When an accident is unavoidable, dual-stage front airbags, front side-impact airbags and side curtain airbags help to protect against injury. Front seat occupants are also protected by an intelligent airbag system that detects passenger weight, seatbelt use and driver seat position, then deploys the airbags accordingly. Front seats feature seatbelts with pretensioners and load limiters as well as passive safety head restraints, which move forward automatically to cradle the head and neck and lessen the risk of whiplash injuries in a rear-end collision.

\*SRS = Supplemental Restraint System  
Most effective when used in conjunction with seatbelts.



SRS\* side curtain airbags



SRS\* dual-stage front airbags

SRS\* front side-impact airbags



Three 3-point rear seatbelts

Passive safety head restraints

## Ring-shaped reinforcement frame

Subaru's exceptional passive safety technologies help to offer a 360-degree barrier of protection. As a result of the use of Computer-Aided Design (CAD) as well as cutting-edge welding and hydro-forming techniques, the 2005 Legacy's newly-designed ring-shaped reinforcement frame is engineered to provide best-in-class collision safety for both driver and passengers while helping to reduce weight and increase structural rigidity. The Legacy also features enhanced energy-absorbing crumple zones and side-impact door beams to further cement its reputation for world-class collision safety.

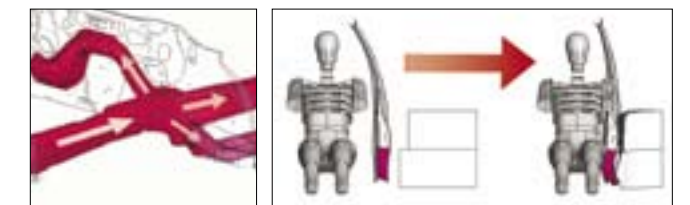

Front collision measures

Side collision measures

## Pedestrian protection

Thanks to energy-absorbing front bumpers and innovative wipers that break away when subjected to enough force, the 2005 Legacy not only protects its driver and occupants, but also those outside the vehicle. The Legacy's aluminum hood is also designed to minimize pedestrian injury in the event of a collision. Due to the distance between the energy-absorbing hood and the compact SUBARU BOXER engine, pedestrians are less likely to come into contact with the engine during a collision.



Before collision

After collision

Break-away wipers



# thinking responsibly

We want all Subaru owners to take pride in the fact that they are driving vehicles that are as environmentally friendly as we can possibly make them. Subaru is completely committed to environmental and energy issues, so we make every effort to reduce weight and improve vehicle aerodynamics, increasing fuel economy while reducing emissions to the lowest possible levels. We also develop recycling technologies that help to make efficient use of natural resources and cut down on waste. It is this kind of thinking and technology that will bring us all a better future.





2.5i Limited Wagon

# the SPACE

FLEXIBLE SPACE

## Accommodating by design.

Beyond the all-new 2005 Legacy's sophisticated performance and style is a practical vehicle that has been intelligently designed to accommodate a tremendous amount of cargo. Due to the ingenious design of the rear suspension, the Legacy Sedan offers impressive trunk space that can also accommodate long items thanks to a folding pass-through space between the rear seats. However, if you need a truly cavernous cargo area, the Legacy Wagon features 60/40-split-folding rear seats that fold down to produce a large, flat-floored cargo space with more storage capacity than many large sport-utility vehicles.



60/40-split-folding rear seats (Wagon)



Full flat cargo area (Wagon)



60/40-split-folding rear seats (Wagon)



Full flat cargo area (Wagon)



Retractable cargo cover (Wagon)



Folding armrest with trunk pass through (Sedan)



Trunk (Sedan)

A higher quality cockpit.



2.5GT Limited

The driver's seat of the 2005 Legacy is an exhilarating place. Designed to both stimulate your passion for driving and ensure your total comfort, the Legacy features luxurious appointments, a distinct, pulse-quickenning sport feel and a level of sophistication normally associated with the finest European sedans and wagons. Whether you are running a simple errand or travelling across the province, the Legacy offers a sophisticated, comfortable and stylish environment to inspire the act of driving.

A higher quality of living.



2.5GT Limited (Wagon)

While the 2005 Legacy is indeed a driver's car, passengers will also appreciate the time and effort that went into designing and crafting the spacious interior. With plenty of leg-, shoulder- and headroom and premium cloth fabric or leather seating surfaces, passengers are able to sit back and enjoy the ride. With soft-touch surfaces, cleverly designed interior storage spaces and high-quality materials throughout, the interior of the Legacy is a world-class environment for both driver and passengers.





### Legacy 2.5i

Besides its symmetrical full-time AWD system, the well-equipped 2005 Legacy 2.5i features: AM/FM/CD audio system; ABS with EBD; ETC; A/C; dual exhaust; front, side-impact and side curtain SRS airbags; passive safety front seat head restraints; advanced ring-shaped reinforcement frame; 16" aluminum alloy wheels; anti-theft security system; cruise control; optional 4-speed SPORTSHIFT™ automatic transmission; power windows and locks with keyless entry; heated front seats and side mirrors; dual 12V power outlets; 6-way adjustable driver's seat and premium black woven-cloth interior. 2.5i Wagon models also feature: 60/40-split-folding rear seats; roof rails; retractable cargo cover and a rear spoiler.



2.5i Wagon



2.5i Sedan

### Legacy 2.5i Limited

Beyond the features offered in the 2005 Legacy 2.5i, the 2.5i Limited boasts a long list of features designed to make driving all the more pleasurable, including: luxurious black leather seating; in-dash six-CD audio system; dual zone automatic climate control; tinted, power glass moonroof; 8-way power adjustable driver's seat; halogen projector beam fog lights; standard 4-speed SPORTSHIFT™ automatic transmission and leather-wrapped controls. 2.5i Limited Wagon models also feature a cargo tray and a roof rack system with lockable cross bars.



2.5i Limited Wagon



2.5i Limited Sedan



### Legacy 2.5GT

Over and above the features found on the 2005 Legacy 2.5i, the 250 hp, turbocharged and intercooled 2.5GT model includes: 17" GT type aluminum alloy wheels with Z-rated tires; large, ventilated front and rear disc brakes; AVCS; in-dash six-CD premium audio system; leather-wrapped controls; dual-zone automatic climate control; engine immobilizer; hood scoop; integrated turn-signal side mirrors; electroluminescent sport gauges; halogen projector beam fog lights; front sport seats; MOMO steering wheel; limited-slip rear differential; premium black woven-cloth interior and an optional 5-speed SPORTSHIFT™ automatic transmission with VTD. 2.5GT Wagon models also feature a cargo tray and roof rack system with lockable cross bars.



2.5GT Wagon



2.5GT Sedan

### Legacy 2.5GT Limited

In addition to all the features offered in the 2005 Legacy 2.5GT, the flagship 2.5GT Limited includes perforated black leather sport seats, an 8-way power adjustable driver's seat and a 4-way power adjustable passenger seat, plus a tinted, power glass moonroof to give discerning drivers both world-class performance and extraordinary interior comfort.



2.5GT Limited Wagon



2.5GT Limited Sedan



# the SPECIFICATIONS

## Engine

	Legacy 2.5i Sedan & Wagon (2.5i) Legacy 2.5i Limited Sedan & Wagon (2.5i Ltd)		Legacy 2.5GT Sedan & Wagon (2.5GT) Legacy 2.5GT Limited Sedan & Wagon (2.5GT Ltd)
<i>Type</i>	2.5L Single Overhead Cam (SOHC), 16-valve, horizontally-opposed, 4-cylinder boxer engine, Electronic Throttle Control (ETC)	<i>Type</i>	2.5L Dual Overhead Cam (DOHC), 16-valve, horizontally-opposed, high output, 4-cylinder boxer engine with turbocharger and intercooler, Electronic Throttle Control (ETC) and Active Valve Control System (AVCS)
<i>Power</i>	168 hp @ 5,600 rpm	<i>Power</i>	250 hp @ 6,000 rpm
<i>Torque</i>	166 lb-ft @ 4,000 rpm	<i>Torque</i>	250 lb-ft @ 3,600 rpm
	<i>Meets Low Emission Vehicle (LEV) standards</i>		<i>Meets Low Emission Vehicle (LEV) standards</i>

## Transmission and Drivetrain

<i>Manual Transmission</i>	5-speed manual transmission (5MT), standard (2.5i) 5-speed reinforced manual transmission (5MT), standard (2.5GT, 2.5GT Ltd) AWD type: Viscous-coupling limited-slip centre differential
<i>Automatic Transmission</i>	4-speed electronic direct control SPORTSHIFT™ automatic transmission (4EAT SS), standard (2.5i Ltd), optional (2.5i) AWD type: Electronically controlled multi-plate transfer clutch
<i>Automatic Transmission</i>	5-speed electronic direct control SPORTSHIFT™ automatic transmission (5EAT SS), optional (2.5GT, 2.5GT Ltd) AWD type: Variable Torque Distribution (VTD) with lateral g-sensor and an electronically controlled locking centre differential
<i>Drivetrain</i>	Subaru symmetrical full-time All-Wheel Drive system Limited slip rear differential (viscous type) (2.5GT, 2.5GT Limited)

## Chassis

<i>Suspension</i>	4-wheel fully-independent
<i>Brakes</i>	Power-assisted, dual-diagonal system ABS 4-channel/4-sensor/4-wheel Electronic Brake-Force Distribution (EBD) Front: Ventilated discs 274 x 24 mm (2.5i), 291 x 24 mm (2.5i Ltd), 312 x 30 mm (2.5GT, 2.5GT Ltd), twin piston calipers Rear: Solid discs 270 x 10 mm, single piston calipers (2.5i, 2.5i Ltd); ventilated discs 287 x 18 mm, single piston calipers (2.5GT, 2.5GT Ltd)
<i>Steering</i>	Engine speed sensitive, power-assisted rack and pinion (2.5i, 2.5i Ltd), quick ratio (2.5GT, 2.5GT Ltd) 10.8 m minimum turning circle (curb-to-curb)

Measurements	2.5i Sedan	2.5i Wagon	2.5i Ltd Sedan	2.5i Ltd Wagon	2.5GT Sedan	2.5GT Wagon	2.5GT Ltd Sedan	2.5GT Ltd Wagon
Fuel economy: Manual transmission (City/Hwy) (L/100km)	10.4/7.3	10.4/7.3	-	-	12.4/8.6	12.4/8.6	12.4/8.6	12.4/8.6
Fuel economy: Automatic transmission (City/Hwy) (L/100km)	10.4/7.2	10.4/7.2	10.4/7.2	10.4/7.2	12.3/8.6	12.4/8.7	12.3/8.6	12.4/8.7
Fuel: Recommended minimum octane (AKI)	87	87	87	87	91	91	91	91
Fuel tank capacity (L)	64	64	64	64	64	64	64	64
Curb weight: Manual transmission (kg)	1450	1475	-	-	1495	1520	1525	1555
Curb weight: Automatic transmission (kg)	1470	1495	1500	1530	1525	1550	1555	1585
Gross Vehicle Weight Rating (GVWR) (kg)	1960	1960	1960	2010	2010	2060	2010	2060
Towing capacity: Maximum weight (kg) with trailer brakes†	1224	1224	1224	1224	1224	1224	1224	1224
Towing capacity: Maximum weight (kg) without trailer brakes†	453	453	453	453	453	453	453	453
Length (mm)	4730	4795	4730	4795	4730	4795	4730	4795
Width (mm) with mirrors	1945	1945	1945	1945	1992	1992	1992	1992
Height (mm) (with roof rails*)	1425	1475*	1425	1475*	1425	1475*	1425	1475*
Wheelbase (mm)	2670	2670	2670	2670	2670	2670	2670	2670
Track: Front/Rear (mm)	1495/1485	1495/1485	1495/1485	1495/1485	1495/1485	1495/1485	1495/1485	1495/1485
Minimum ground clearance (at curb weight) (mm)	150	150	150	150	150	155	150	155
Headroom: Front/Rear (mm)	1003/935	1029/1002	954/935	984/937	1003/935	1029/1002	954/935	984/937
Legroom: Front/Rear (mm)	1119/860	1119/860	1119/860	1119/860	1119/860	1119/860	1119/860	1119/860
EPA interior volume (L)	2959	3707	2959	3707	2959	3707	2959	3707
Cargo area: EPA trunk volume (L)	433	-	433	-	433	-	433	-
Cargo area: EPA volume (seats up) (L)	-	949	-	909	-	949	-	909
Cargo area: SAE volume (seats folded flat) (L)	-	1874	-	1747	-	1874	-	1747
Roof Rack System: Maximum load (kg)	-	45	-	45	-	45	-	45

†See owner's manual for detailed towing instructions

Legacy 2.5i Sedan & Wagon  
Legacy 2.5i Limited Sedan & Wagon  
Legacy 2.5GT Sedan & Wagon  
Legacy 2.5GT Limited Sedan & Wagon

## Safety and Security

• • • •	Airbags (SRS): Driver and front passenger, dual stage deployment
• • • •	Airbags (SRS): Front seat side-impact
• • • •	Airbags (SRS): Side curtain
• • • •	Airbags (SRS): Driver's seat position sensor
• • • •	Airbags (SRS): Passenger occupant detection system with on/off indication
• • • •	Brake pedal: Collapsible, passive safety type
• • • •	Child safety: Rear door locking system
• • • •	Child safety: Rear seat ISO-FIX/LATCH anchor system
• • • •	Driver's foot rest: Impact absorbing
• • • •	Head restraints (front): Height adjustable, passive safety type
• • • •	Head restraints (rear): Removable and adjustable
• • • •	Seatbelts (front): 3-point with pretensioners and load limiters (ELR)
• • • •	Seatbelts (front): Height adjustable shoulder belt anchors
• • • •	Seatbelts (rear): 3-point, all seating positions (ALR/ELR)
• • • •	Security: Anti-theft system
- - • •	Security: Engine immobilizer system
• • • •	Security: Keyless entry system with panic alarm
◦ ◦ ◦ ◦	Security: Shock sensor
• • • •	Steering column: Collapsible
• • • •	Structure: Advanced ring-shaped reinforcement frame
• • • •	Structure: Dual, side-impact door beams (front & rear)
• • • •	Structure: Energy-absorbing crumple zones (front & rear)
• • • •	Trunk: Internal safety release with self-illuminating handle (sedan only)

## Seating and Trim

• • • •	Accents/trim: Titanium finish
• • • •	Floor mats: "Legacy" embroidered
• - • -	Interior: Flat woven premium cloth upholstery
- • - •	Interior: Leather upholstery and interior trim
5 5 5 5	Seating capacity
• - • -	Seat (driver's): 6-way manual adjustable with lumbar support
- • - •	Seat (driver's): 8-way power adjustable with lumbar support
• • • -	Seat (front): Passenger, 4-way manual adjustable
- - - •	Seat (front): Passenger, 4-way power adjustable with lumbar support
• • • •	Seats (front): Heated with four level settings
• • - -	Seats (front): Standard reclining bucket type
- - • •	Seats (front): Sport type
• • • •	Seats (rear): 60/40 split, flat folding (wagon only)
• • • •	Seats (rear): Folding armrest with trunk pass through (sedan only)

Legacy 2.5i Sedan & Wagon  
Legacy 2.5i Limited Sedan & Wagon  
Legacy 2.5GT Sedan & Wagon  
Legacy 2.5GT Limited Sedan & Wagon

• standard  
◦ accessory  
- not available

## Exterior

• • • •	Body: Anti-corrosion treatment
• • • •	Body: Dual-sided galvanized steel
- - • •	Body: Under body aerodynamic covers
• • • •	Bumper (rear): Integrated step pad (wagon only)
• • • •	Door mirrors: Power adjustable, foldable & heated (body colour)
- - • •	Door mirrors: Integrated LED turn-signals
- - • •	Door sills: Aluminum
• • • •	Doors: 4, body colour handles
◦ • • •	Fog lights: Projector beam halogen
• • • •	Headlights: Auto-off with ignition switch
• • • •	Headlights: Contoured multi-reflector halogen high beam
• • • •	Headlights: Projector beam halogen low beam
• • • •	Hood: Aluminum alloy
- - • •	Hood: Functional hood scoop for intercooler air flow
- • - •	Moonroof: Glass, power tilting and sliding with sunshade (sedan only)
- • - •	Moonroof: Twin glass, power tilting and sliding with sunshade (wagon only)
• • • •	Roof Rack System: Low profile roof rails (black) (wagon only)
◦ • • •	Roof Rack System: Cross bars (lockable) (wagon only)
◦ ◦ ◦ ◦	Splash guards (wagon only)
◦ ◦ ◦ ◦	Spoiler: Low profile, integrated brake light (sedan only)
• • • •	Spoiler: Roof line (wagon only)
• • - -	Tire (spare): Compact T135/80 R16 (under cargo area)
- - • •	Tire (spare): Compact T135/70 D17 (under cargo area)
• • - -	Tires: 205/55 R16 89H Bridgestone Potenza RE92 All-Season
- - • •	Tires: 215/45 ZR17 Bridgestone Potenza RE92A All-Season M+S
• • - -	Wheels: 16" x 6.5" aluminum alloy, 10-spoke Legacy design
- - • •	Wheels: 17" x 7" aluminum alloy, 5-spoke Legacy GT design
• • • •	Windows: Tinted
• • • •	Windshield: Laminated and tinted green
- • • •	Windshield: Dark upper sunshade band
• • • •	Window (rear): Defogger with timer
• • • •	Wipers (windshield): Heated glass de-icer
• • • •	Wipers (windshield): Variable intermittent with washer and driver side fin
• • • •	Wiper (rear window): Intermittent and continuous mode with washer (wagon only)
	<b>Audio</b>
• - - -	AM/FM/CD
- • • •	AM/FM/6CD Premium audio system
• • • •	Antenna: In-glass integrated
4 4 4 4	Speakers (main)
2 2 2 2	Speakers: Door tweeters
◦ ◦ ◦ ◦	Speakers: Subwoofer

- Legacy 2.5i Sedan & Wagon
- Legacy 2.5i Limited Sedan & Wagon
- Legacy 2.5GT Sedan & Wagon
- Legacy 2.5GT Limited Sedan & Wagon

### Controls

- • • • Climate control: Air conditioning
- • • • Climate control: Automatic, dual zone
- • • • Cruise control: Steering wheel controls
- - - - Gear selector: Soft-grip
- • • • Gear selector: Leather-wrapped
- - - - Parking brake: Soft-grip
- • • • Parking brake: Leather-wrapped
- - - - Steering wheel: Soft-grip
- • - - Steering wheel: Leather-wrapped
- - • • Steering wheel: MOMO, leather-wrapped
- • • • Steering wheel: Tilt adjustable
- - • • Transmission shift controls: Steering wheel mounted for 5EAT SS

### Instruments

- • • • Clock: Digital LED in dash
- • • • Gauges: Full needle sweep on start-up
- • - - Gauges: Analog with red illuminated needles
- - • • Gauges: Electroluminescent
- - • • Gauges: Sport design
- • • • Instrument panel: Automatic transmission Sport mode indicator (4EAT SS and 5EAT SS)
- • • • Instrument panel: Automatic transmission SPORTSHIFT™ gear position indicator (4EAT SS and 5EAT SS)
- • • • Instrument panel: Coolant temperature gauge
- • • • Instrument panel: Fuel gauge with low fuel warning light
- • • • Odometer: Digital, dual trip modes
- • • • Speedometer: Electronically controlled analog
- • • • Tachometer
- • • • Trip computer: Elapsed time, ambient temperature, fuel economy, driving range
- • • • Warning lights: ABS, airbag, brake fluid, oil pressure, check engine, door ajar warning

### Cargo Area

- • • • Cargo tray/protective mat (wagon only)
- • • • Grocery bag hooks (wagon only)
- • • • Light: Cargo area
- - • • Rear gate sill cover: Aluminum (wagon only)
- • • • Remote trunk release, floor mounted (sedan only)
- • • • Retractable cargo cover (wagon only)
- • • • Storage: Sub-floor tray

- Legacy 2.5i Sedan & Wagon
- Legacy 2.5i Limited Sedan & Wagon
- Legacy 2.5GT Sedan & Wagon
- Legacy 2.5GT Limited Sedan & Wagon

- standard
- accessory
- not available

### Convenience

- • • • Armrest (front): With console storage
- • • • Battery: Anti-drain system
- • • • Cup holders (front): Console integrated
- • • • Cup holders (rear): Retractable
- • • • Door locks: Power, remote keyless entry (separate door and cargo access controls)
- • • • Glove box: Lockable and illuminated
- • • • Ignition key ring: Illuminated
- • • • Light: Front door courtesy light
- • • • Light: Interior dome with off delay
- • • • Light: Map spotlights
- • • • Power outlet: 12V in console, 12V in dash
- • • • Storage: Front door compartments
- • • • Storage: Dash compartment, illuminated with lid
- • • • Storage: Passenger seatback storage pocket
- • • • Visor: Dual, with illuminated mirrors
- • • • Windows (power): Driver's window auto down

### Colours

- B B B B Atlantic Blue Pearl
- B B B B Brilliant Silver Metallic
- - B B Garnet Red Pearl
- B B B B Obsidian Black Pearl
- B B B B Regal Blue Pearl
- B B B B Satin White Pearl
- B Black Interior - not available

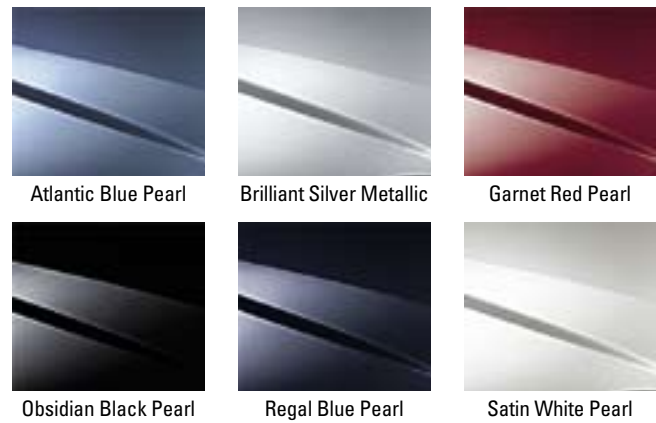

### Warranties

- 3 years / 60,000 km "bumper to bumper" no deductible limited warranty
- 5 years / 100,000 km major components and powertrain
- 3 years / unlimited km CAA roadside assistance
- See warranty book for details and limitations.



Great journeys begin in a Subaru. Enjoy.