

RAV4 | 2011



 **TOYOTA**  
make things better



# RAV4

Inside and out, you'll find the unexpected with the 2011 RAV4. With a surprisingly spacious interior, RAV4 combines remarkable fuel-economy and agility into one sleek package. Whether you choose the 2WD 4-cylinder engine, or the 4WD with 4-cylinder or V6 engine, you'll have the sure footed traction to get you wherever you're going. Exceeding expectations – that's how we make things better with the 2011 RAV4.

#### FRONT COVER

Sport V6 4WD shown in Pacific Blue Metallic.

**A.** Limited V6 4WD shown in Classic Silver Metallic. **B.** Base 2WD shown in Pyrite Mica.



#### Built in Canada<sup>6</sup>

Nearly all 2011 RAV4 vehicles are built at our Woodstock, Ontario assembly plant. The first Canadian-built RAV4 rolled off the line in 2008.



# Base

4-cylinder 2WD/4WD  
V6 4WD

RAV4 Base offers a level of standard features that's anything but basic. For starters, its fuel-efficient 2.5-litre 4-cylinder is rated at 179 hp. That's the kind of responsive power you might not expect from a 4-cylinder engine. If you're looking for a little more punch, RAV4 4WD Base is also available with a 3.5-litre, 269 hp V6 engine. And how's this for exceeding expectations - every RAV4 model comes with your choice of 2WD or 4WD.

## FUEL CONSUMPTION<sup>2</sup>

9.4 City/6.9 Highway L/100 km  
2WD 2.5-litre, 4-cylinder with automatic transmission  
9.7 City/7.2 Highway L/100 km  
4WD 2.5-litre, 4-cylinder with automatic transmission

## SELECT FEATURES

- 179 hp, 2.5-litre, 4-cylinder, DOHC, 16-valve, Dual VVT-i engine with sequential multiport electronic fuel injection.
- 269 hp, 3.5-litre, V6, DOHC, 24-valve, Dual VVT-i engine with sequential multiport electronic fuel injection. [4WD only]
- 2WD - Front Engine/Front Wheel Drive, 4WD - Active Torque Control.
- Power-assisted, ventilated front discs, solid rear disc brakes.
- Antilock Braking System with Electronic Brake-force Distribution and Brake Assist
- Super Electronically Controlled Transmission with gate-type shifter.
- AM/FM CD/MP3/WMA player, 6-speakers, audio auxiliary input jack.
- Air conditioning, rear seat heater ducts.
- 60/40 split rear bench seat with fold-down seat back.
- 50/50 Split and Stow 3rd Row™ bench seat (optional Base V6 4WD only).
- Active front headrests.
- Dual-stage driver and front passenger airbags, front seat-mounted side airbags, roll-sensing front and rear head/side curtain airbags Supplemental Restraint System.<sup>1</sup>
- Coloured-Keyed moulded spare tire cover.
- Automatic headlamp cancel function.

**A.** Base V6 4WD with optional 17-inch aluminum alloy wheels shown in Pyrite Mica. **B.** Base V6 4WD interior shown in Ash.



# Sport

4-cylinder 2WD/4WD  
V6 4WD

The RAV4 Sport offers style and grace in one performance minded package. Its unique 18-inch aluminum alloy wheels, power tilt/slide moonroof with sunshade and 6-speaker audio system all enhance your driving experience. Plus an available leather interior with heated driver and front passenger seats complete RAV4 Sport's sleek design, inside and out.

## FUEL CONSUMPTION<sup>2</sup>

9.4 City/6.9 Highway L/100 km  
2WD 2.5-litre, 4-cylinder with automatic transmission  
9.7 City/7.2 Highway L/100 km  
4WD 2.5-litre, 4-cylinder with automatic transmission

## SELECT FEATURES

- 179 hp, 2.5-litre, 4-cylinder, DOHC, 16-valve, Dual VVT-i engine with sequential multiport electronic fuel injection.
- 269 hp, 3.5-litre, V6, DOHC, 24-valve, Dual VVT-i engine with sequential multiport electronic fuel injection. [4WD only]
- 2WD - Front Engine/Front Wheel Drive, 4WD - Active Torque Control.
- Power-assisted, ventilated front disc and solid rear disc brakes.
- Vehicle Stability Control, Traction Control System.
- AM/FM CD/MP3/WMA player, 6-speakers, audio auxiliary input jack.
- Air conditioning, rear seat heater ducts.
- Sport badges.
- Dual-stage driver and front passenger airbags, front seat-mounted side airbags, roll-sensing front and rear head/side curtain airbags Supplemental Restraint System.<sup>1</sup>
- P235/55R18 all-season radial tires.
- 18-inch aluminum alloy wheels.

**A.** RAV4 Sport V6 4WD with Appearance Package shown in Magnetic Grey Metallic. **B.** The roomy Sport 4WD interior shown in optional Dark Charcoal leather. The rear seats fold down flat so that you can make the most of the 2.07 cubic metres [73 cubic feet] of space. **C.** No matter where you take your RAV4, your tunes can always travel with you. An auxiliary audio jack for MP3/WMA devices is located on the front centre console.



# Limited

4-cylinder 2WD/4WD  
V6 4WD

From the smooth contours of the centre console to the soft textures of the optional leather seats – every aspect of RAV4 Limited has been designed with refined elegance and comfort in mind. With the innovative Smart Key System you can start RAV4 Limited with the push-button ignition. The integrated switches on the leather-wrapped steering wheel let you control the 6-disc in-dash stereo system to create an exceptional driving experience.

## FUEL CONSUMPTION<sup>2</sup>

9.4 City/6.9 Highway L/100 km  
2WD 2.5-litre, 4-cylinder with automatic transmission  
9.7 City/7.2 Highway L/100 km  
4WD 2.5-litre, 4-cylinder with automatic transmission

## SELECT FEATURES

- 179 hp, 2.5-litre, 4-cylinder, DOHC, 16-valve, Dual VVT-i engine with sequential multiport electronic fuel injection.
- 269 hp, 3.5-litre, V6, DOHC, 24-valve, Dual VVT-i engine with sequential multiport electronic fuel injection. [4WD only]
- 2WD – Front Engine/Front Wheel Drive, 4WD – Active Torque Control.
- Power-assisted, ventilated front disc and solid rear disc brakes.
- AM/FM CD/MP3/WMA 6-disc changer, 6-speakers, audio auxiliary input jack.
- Dual zone automatic climate control, soft touch heater controls, rear seat heater ducts.
- Tonneau cover.
- Push Button Start, Smart Key System.
- Power 8-way adjustable driver's seat.
- Dual-stage driver and front passenger airbags, front seat-mounted side airbags, roll-sensing front and rear head/side curtain airbags Supplemental Restraint System.<sup>1</sup>
- P225/65R17 all-season radial tires.
- 17-inch aluminum alloy wheels.
- Fog lamps.
- Automatic headlamp system.

**A.** Limited V6 4WD shown in Classic Silver Metallic.  
**B/C.** The elegant RAV4 Limited 4WD interior shown in optional Ash leather.



# Safety

Toyota engineered RAV4 to earn the confidence of its driver. Which is why RAV4 is available with several advanced traction technologies including available Electronic On-Demand 4-wheel drive, which helps optimize grip when necessary by automatically switching from fuel-efficient front-wheel-drive to 4WD mode. The RAV4's advanced airbag system<sup>1</sup> includes both driver and front passenger airbags and is complemented by front seat-mounted side airbags as well as first- and second-row Roll-Sensing Side Curtain Airbags.

**(A)** Dual-stage driver and front passenger airbag Supplemental Restraint System.<sup>1</sup> **(B)** Front seat-mounted side airbags.<sup>1</sup> **(C)** Roll-sensing front and rear head/side curtain airbags.<sup>1</sup> **(D)** 3-point seatbelts in all seating positions.



The sideview mirror mounted turn signal offers added safety and increased visibility to drivers when turning.



## Safety and Performance Features

- Antilock Braking System with Electronic Brake-force Distribution and Brake Assist.
- Vehicle Stability Control, Traction Control System.
- 2WD – Front Engine/Front Wheel Drive, 4WD – Active Torque Control.
- Hill-Start Assist Control and Downhill Assist Control [V6 models only].
- Dual-stage driver and front passenger airbags, front seat-mounted side airbags, roll-sensing front and rear head/side curtain airbags Supplemental Restraint System.<sup>1</sup>
- Front passenger airbag occupancy classification indicator.
- All-position 3-point lap and shoulder belts.
- Front seatbelt pre-tensioners with force limiters.
- Anchor points for child restraint seats.
- Active front headrests with whiplash protection.

RAV4 power is generated by either a 179 hp 2.5-litre 4-cylinder engine or the powerful 269 hp 3.5-litre V6. Both engines are Dual VVT-i with sequential multiport electronic fuel injection.

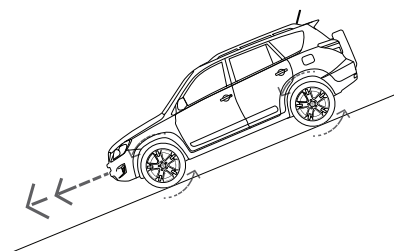

**DOWNHILL ASSIST CONTROL** Available DAC sets a target speed of approximately 6-9 km/h on steep declines. The system applies the brakes, helping eliminate wheel-locking for a more controlled descent.

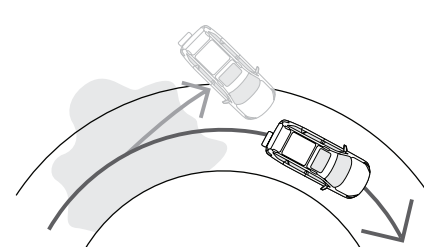

**TRACTION CONTROL** If a wheel loses traction, TRAC limits engine output and/or applies the brake to the spinning wheel, and transfers torque to the wheel that's still got traction.

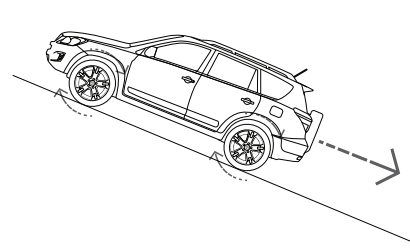

**HILL START ASSIST CONTROL** Available HAC helps ensure a smooth start on inclines, braking for 2-3 seconds to help prevent vehicle rollback as the driver switches from the brake pedal to the accelerator.

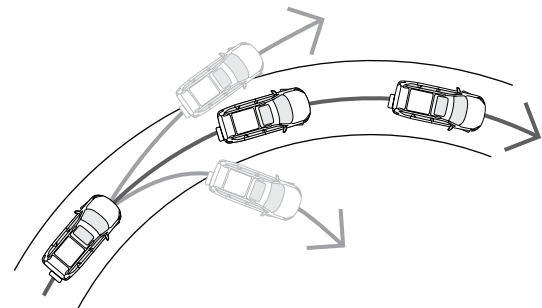

**ENHANCED VEHICLE STABILITY CONTROL** To help improve control in situations that could cause a vehicle to slip sideways while cornering, RAV4 uses Enhanced VSC. It adjusts engine power, braking and steering assist torque to help the driver steer in the direction that provides the greatest control.

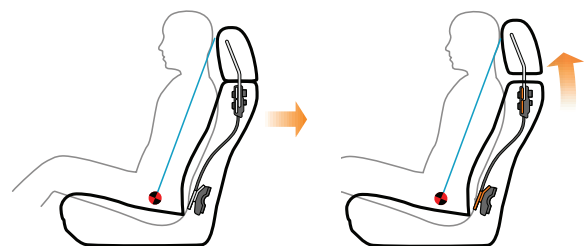

**ACTIVE FRONT HEADREST** In the event of certain rear-end collisions, a mechanism in the lumbar region of the front seats triggers the movement of the headrests up and forward to help position the headrests to better support the occupant's head.

## Toyota Quality

Quality is built right into the production process from the selection of raw materials, right down to the vehicle's final inspection. And it is the responsibility of everyone to ensure the highest quality possible on each and every vehicle. It's through Toyota's philosophy of 'Kaizen' that we are always looking for ways to continually improve. That's how we make things better.

**THE TOYOTA PRODUCTION PROCESS** is one that is constantly evolving. With our "Just-In-Time" practice, the goal is to make certain that during the manufacturing process, only what is needed gets produced. The result is twofold: because there's no excess supply, any issues are exposed and promptly resolved to ensure that everything off of the Toyota assembly line is of exceptional quality.



**THE HUMAN TOUCH.** As impressive as the machinery is, the achievement of perfect fit and finish is also the result of continuous human touch for every step of the way.

**TOYOTA CANADA COLD RESEARCH CENTRE.** Located in Timmins, Ontario, our teams test Toyota vehicles in actual Canadian winter conditions at our cold weather testing track to ensure that they remain dependable throughout the long winter months.



For more information visit [toyota.ca](http://toyota.ca)

## 2011 Colours



040 Alpine White<sup>A,C,F</sup>



070 Blizzard Pearl<sup>A,D</sup>  
(Limited only)



1F7 Classic Silver Metallic<sup>A,C,D,F</sup>



1G3 Magnetic Grey Metallic<sup>C,F</sup>  
(Sport only)



202 Black<sup>A,C,D,F</sup>



3R3 Barcelona Red Metallic<sup>A,C,D,F</sup>



4T3 Pyrite Mica<sup>B,E</sup>  
(Base, Limited only)



6T3 Black Forest Pearl<sup>B,C,E,F</sup>



8R3 Pacific Blue Metallic<sup>A,C,D,F</sup>

## Interior colour options

<sup>A</sup> Ash Fabric.

<sup>B</sup> Sand Beige Fabric.

<sup>C</sup> Dark Charcoal Fabric  
(Sport models only).

<sup>D</sup> Ash Leather.

<sup>E</sup> Sand Beige Leather.

<sup>F</sup> Dark Charcoal Leather  
(Sport models only).

Please see your Toyota Dealer for details.

## New vehicle warranty summary

NO DEDUCTIBLES – NO TRANSFER FEES

**COMPREHENSIVE COVERAGE - 3 YEARS OR 60,000 KM** This warranty includes 24 hour Roadside Assistance and other benefits, as well as coverage of repairs on any part of the vehicle that is defective in material or workmanship under normal use and maintenance. Different warranties apply to original tires.

**POWERTRAIN COMPONENTS - 5 YEARS OR 100,000 KM** This warranty covers repairs to powertrain components that are defective in material or workmanship under normal use and maintenance.

**MAJOR EMISSION CONTROL COMPONENTS - 8 YEARS OR 130,000 KM** This warranty covers repairs to specified major emission components that are defective in material or workmanship under normal use and maintenance.

**CORROSION PERFORATION - 5 YEARS UNLIMITED DISTANCE** Any sheet metal found, under normal use, to have developed a perforation from corrosion due to defects in material or workmanship.

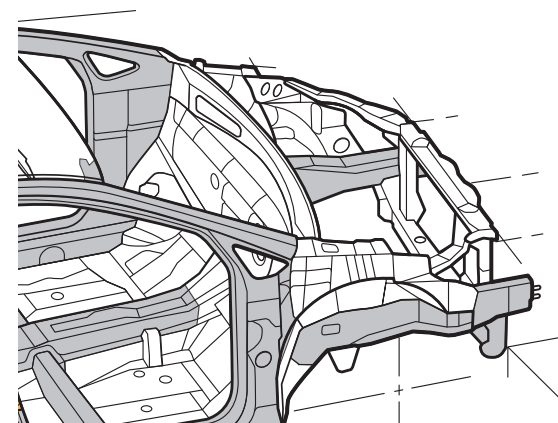

# Accessories

Personalize your vehicle to enhance its appearance and performance with Toyota Accessory Parts. Your Toyota Dealer can help you select the right accessories to suit your individual style. Many of Toyota's Accessory Parts can be residualized or advanced through Toyota Financial Services when purchased at the time of a new vehicle sale, and all are backed by a Toyota Warranty. To view a complete list of accessories specifically designed for your vehicle, visit [customizeyourtoyota.ca](http://customizeyourtoyota.ca), your local Dealer or [toyota.ca](http://toyota.ca).

Whether you prefer convenience, practicality or luxury; adding accessories will help create a RAV4 that is uniquely yours.

- All-Season Mats
- Ashtray
- Block Heater
- Bluetooth®4
- Bodyside Mouldings
- Cargo Liner
- Cargo Mat
- Cargo Net
- Hood Deflector
- Navigation System<sup>5</sup>
- Remote Starter
- Roof Rack Bike Carrier
- Roof Rack Ski/Snowboard Carrier
- Satellite Radio
- Security System
- Side Step Bars
- Side Window Visors
- Tonneau Cover
- Towing Accessories
- Tow Hitch Bike Carrier
- TRD Air Filter
- TRD Oil Cap
- TRD Performance Brake Pads



**Hood Deflector** Protect your vehicle with a high impact deflector that minimizes damage caused by road debris, pebbles and insects.



**Navigation System<sup>5</sup>** Find any destination with the push of a button.

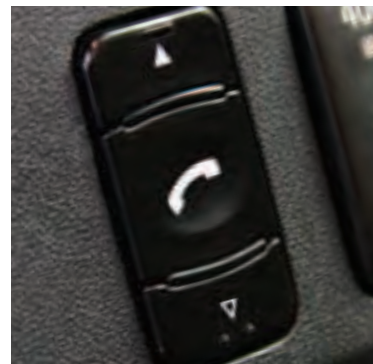

**Bluetooth®4** Keep your hands on the wheel and your eyes on the road as you talk conveniently and safely through the Bluetooth®4 hands free system.



**All-Season Mats** Safeguard your vehicle's interior against mud, slush and salt with custom-fitted All-Season Mats.



**Towing Accessories** Haul with confidence with a towing hitch.



**Side Step Bars**



**Cargo Liner** Protect your interior with this durable vinyl liner which features a raised lip to contain spills for easy cleanup.



**Side Window Visors**

## Discover more with Toyota

At Toyota, our goal is to continuously make things better for you. That's why we offer a wide range of programs and services before and after your vehicle purchase designed to help make your Toyota experience the best it can be.



Fewer emissions and pollutants.<sup>1</sup> More kilometres on less fuel. And power and performance second to none. Available in Prius, Camry and Highlander, these latest generation Toyota hybrids offer you the best of all worlds.



Toyota Dealers are dedicated to making the experience of owning a Toyota both satisfying and rewarding. We service your Toyota the way we built it. So you can count on quality parts and professional service.



If you're looking at leasing or financing, we're here to help. We provide competitive interest rates, flexible terms, and an easy online pre-approval process. The toughest decision should be choosing which Toyota you want. Visit us at [www.toyotafinancialservices.ca](http://www.toyotafinancialservices.ca).



Enhance your Toyota ownership experience by joining Club Toyota – a complimentary and exclusive online service for Toyota owners. Benefit from an abundance of interactive services, and information conveniently at your fingertips. Register today at [clubtoyota.ca](http://clubtoyota.ca).



With Extra Care Protection you receive inflation protected coverage from mechanical failures, road emergencies, and much more. It's affordable peace of mind. Consult your Toyota Dealer for details.



The Toyota Mobility program is dedicated to addressing the transportation needs of Toyota Owners who have a disability, or know a family member with a disability or mobility issue. The program offers cash assistance, resource information and financing for adaptive equipment for their vehicle.



All new Toyota cars and trucks include a full tank of gas, roadside assistance and floor mats.



**Toyota Graduate Program** This program assists new graduates in their purchase of a New or Certified Used Toyota. The program differs depending on the model chosen. Be sure to ask your Dealer when purchasing your Toyota. Some conditions may apply.

<sup>1</sup>Compared against similarly equipped conventional gasoline powered vehicles. Based on North American sales data and Federal Tier 2 engine emission requirements.

## Working together to make things better.

Through education, inspiration, financial support and a long standing commitment to the environment, Toyota Canada is proud to contribute to various community programs that are devoted to the betterment of our planet. To learn more about how we are working to make things better, visit us at [Toyota.ca](http://Toyota.ca)



Photo: Joshua Berson



Photo: Evergreen – Jane Churchill



**Toyota Evergreen Learning Grounds**  
Toyota Canada Inc. and its Dealerships partnered with Evergreen in 2000 to create the Toyota Evergreen Learning Grounds Program, that is transforming Canadian school grounds into natural learning environments. For more information visit [evergreen.ca](http://evergreen.ca)



**Toyota Earth Day Scholarship Program**  
Toyota Canada Inc. and Earth Day Canada established the Toyota Earth Day Scholarship Program in 2003 to recognize and reward graduating high school students who have distinguished themselves through environmental, volunteer and academic excellence. Each year, 15 scholarships are awarded coast to coast, allowing Canada's future environmental leaders to continue their studies. For more information visit [earthday.ca](http://earthday.ca)



**Special Olympics Canada**  
Toyota Canada Inc. and its Dealers are National Sponsors of Special Olympics Canada, which is dedicated to making a difference in the lives of Special Olympics athletes. Toyota Canada Inc. reaches out to Special Olympics athletes whenever possible through participation in events at a local, regional, provincial and national level. For more information visit [specialolympics.ca](http://specialolympics.ca)

## 2011 RAV4 2WD Features

	Base 2WD	Sport 2WD	Limited 2WD
<b>INTERIOR</b>			
AM/FM CD/MP3/WMA Player, 6-Speakers, Audio Auxiliary Input Jack, Auto Sound Levelizer (ASL), Roof-Mounted Antenna	●	●	–
AM/FM CD/MP3/WMA 6-Disc Changer, 6-Speakers, Audio Auxiliary Input Jack, Auto Sound Levelizer (ASL), Steering Wheel Audio Controls, Integrated XM® Satellite Radio, Roof-Mounted Antenna	–	–	●
Air Conditioning	●	●	–
Cabin Air Filter, Rear Seat Heater Ducts	●	●	●
Dual Zone Automatic Climate Control, Soft Touch Heater Controls	–	–	●
Driver & Front Passenger Bucket Seats	●	●	●
Full Fabric Seat Material	●	–	–
Premium Cloth Seat Material	–	●	●
Driver Seat w/Recline, Fore/Aft, Driver Cushion Height Adjustments	●	●	–
Power 8-Way Driver Seat w/Recline, Vertical, Fore/Aft, Lumbar Support, Driver Cushion Height Adjustments	–	–	●
Passenger Seat w/Recline, Fore/Aft Adjustments	●	●	●
60/40 Split Rear Bench Seat w/Fold-Down Seat Back, Fold-Down Centre Armrest, Rear Seat Remote Release in Cargo Area	●	●	●
All-Position Vertically Adjustable Headrests	●	●	●
Power Door Locks	●	●	●
Power Windows w/Driver Side Auto Up/Down	●	●	●
Optitron Gauges	●	●	●
Tachometer, Outside Temperature Gauge, Water Temperature Gauge, Dual Trip Odometer, Fuel Economy Meter	●	●	●
Dual Vanity Mirrors	●	●	●
Auto-Dimming Rear View Mirror w/Integrated Backup Camera	–	–	●
3-Spoke Telescopic, Tilt Steering Wheel	●	●	●
Leather-Wrapped Steering Wheel & Shift Knob	–	–	●
Dark Silver Brushed Metallic Trim	●	●	●
Interior Chrome Trim	–	–	●
Tonneau Cover	–	●	●
Carpeting, Carpet Floor Mats	●	●	●
Push Button Start, Smart Key System	–	–	●
Cruise Control	●	●	●
Digital Clock	●	●	●
Front & Rear Cup Holders	●	●	●

● = Standard ○ = Optional – = Not Available

	Base 2WD	Sport 2WD	Limited 2WD
<b>INTERIOR (cont'd)</b>			
Coat Hooks	●	●	●
Centre Console Box w/Armrest	●	●	●
Upper & Lower Glove Box	●	●	●
Driver & Front Passenger Seat Back Pockets	●	●	●
Door Map Pockets	●	●	●
Cargo Area Tie-Down Rings	●	●	●
Large Capacity Storage Box Under Rear Deck	●	●	●
Overhead Sunglass Storage	●	●	●
Back Door Cargo Net Pocket	●	●	●
Map Lamps	●	●	●
Cargo Lamp	●	●	●
Accessory Power Outlet, Retained Accessory Power	●	●	●
Keyless Entry	●	●	●
Illuminated Entry, Illuminated Ignition Key	●	●	●
<b>SAFETY</b>			
Dual-Stage Driver & Front Passenger Airbag Supplemental Restraint System (SRS) <sup>1</sup>	●	●	●
Front Passenger Airbag Occupancy Classification Indicator	●	●	●
Front Seat-Mounted Side Airbags (SRS) <sup>2</sup>	●	●	●
Roll-Sensing Front & Rear Head/Side Curtain Airbags (SRS) <sup>3</sup>	●	●	●
Active Front Headrests w/Whiplash Protection	●	●	●
Front Seatbelt Pre-Tensioners & Force Limiters	●	●	●
All-Position 3-Point Lap & Shoulder Belts	●	●	●
Front Seatbelt Anchor Height Adjusters	●	●	●
Anchor Points for Child Restraint Seats	●	●	●
Child Protector Rear Door Locks	●	●	●
Engine Immobilizer	●	●	●
Assist Grips	●	●	●
Remote Fuel Lid Release	●	●	●
Fuel Cap Hanger	●	●	●
Door Ajar, Low Washer Fluid, Low Fuel, ATM Oil Temp, Driver & Front Passenger Seatbelt Warning Indicators	●	●	●

	Base 2WD	Sport 2WD	Limited 2WD
<b>EXTERIOR</b>			
16" Steel Wheels, Full Wheel Covers	●	–	–
17" Aluminum Alloy Wheels, Wheel Locks	–	–	●
18" Aluminum Alloy Wheels, Wheel Locks	–	●	–
Side Window Defoggers	●	●	●
Electric Rear Window Defroster w/Timer	●	●	●
High Solar Energy Absorbing Window Glass	●	●	●
Rear Privacy Glass	–	●	●
Coloured Mirrors, Front & Rear Splash Guards	●	●	●
Roof Rails, Roof Rail Crossbars	–	●	●
Coloured Door Handles, Fender Flares	–	●	●
Power Moonroof w/Sunshade	–	●	●
Rear Bumper Protector	●	●	●
Colour-Keyed Moulded Spare Tire Cover	●	●	–
Colour-Keyed Hard-Shell Spare Tire Cover	–	–	●
Rear Spoiler	●	–	●
Sport Badges, Sport Grade Rear Spoiler	–	●	–
Limited Front Grille & Badges	–	–	●
Dual Heated, Power Adjustable Mirrors, Integrated Signal Lamps	●	●	●
Variable Intermittent Wipers, Wiper De-Icer	●	●	●
Rear Window Intermittent Wiper/Washer	●	●	●
Halogen Headlamps, LED Brake Lamps	●	●	●
Automatic Headlamp Cancel Function	●	–	–
Automatic Headlamp System	–	●	●
Black Headlamp Surround	–	●	–
Fog Lamps	–	●	●
<b>PACKAGE</b>			
<b>Touring Package:</b>			
17" Styled Steel Wheels, 6-Disc CD Changer, Steering Wheel Audio Controls, Integrated XM® Satellite Radio, Premium Cloth Seat Material, Rear Privacy Glass, Tonneau Cover, Power Moonroof w/Sunshade, Coloured Door Handles, Roof Rails, Roof Rail Crossbars	○	–	–

## 2011 RAV4 2WD Specifications

	Base 2WD	Sport 2WD	Limited 2WD
<b>MECHANICAL</b>			
<b>Engine</b>			
2.5 Litre, 4-Cylinder, DOHC, 16-Valve, Dual Variable Valve Timing w/intelligence (Dual VVT- <i>i</i> ), Sequential Multiport Electronic Fuel Injection	●	●	●
<b>Compression Ratio</b>			
10.4:1	●	●	●
<b>Horsepower</b>			
179 hp [134 kW] @ 6000 rpm	●	●	●
<b>Torque</b>			
172 lb.ft. [235 N.m.] @ 4000 rpm	●	●	●
<b>Suspension</b>			
<b>Front:</b> Independent MacPherson Strut w/Stabilizer Bar & Hydraulic Shock Absorbers	●	●	●
<b>Rear:</b> Double-Wishbone Coil Spring Rear Suspension w/Trailing Arms & Hydraulic Shock Absorbers & Stabilizer Bar	●	●	●
<b>Front/Rear:</b> Sport Tuned Suspension	–	●	–
<b>Drivetrain</b>			
Front Engine/Front Wheel Drive	●	●	●
Vehicle Stability Control (VSC), Traction Control System (TRAC), Automatic Limited Slip Rear Differential	●	●	●
<b>Transmission</b>			
4-Speed, Automatic, Overdrive, Super Electronically Controlled Transmission (Super ECT), Gate-Type Shifter, Transmission Cooler	●	●	●
<b>Brakes</b>			
Power-Assisted, Ventilated Front Discs, Solid Rear Discs, Antilock Braking System (ABS) w/Electronic Brake-force Distribution (EBD) & Brake Assist (BA)	●	●	●
<b>Steering</b>			
Electric Rack & Pinion w/Variable Power Assist	●	●	●
<b>Tires</b>			
P215/70R16, All-Season Radials, Full-Size Spare w/Steel Wheel	●	–	–
P225/65R17, All-Season Radials, Full-Size Spare w/Steel Wheel	–	–	●
P235/55R18, All-Season Radials, Full-Size Spare w/Alloy Wheel	–	●	–

	Base 2WD	Sport 2WD	Limited 2WD
<b>DIMENSIONS</b>			
<b>Length</b>	4620 [181.9]	●	●
<b>Width</b>	1815 [71.5]	●	–
	1855 [73.0]	–	●
<b>Height (Unloaded)</b>	1685 [66.3]	●	–
	1745 [68.7]	–	●
<b>Wheelbase</b>	2660 [104.7]	●	●
<b>Track</b>	<b>Front:</b> 1560 [61.4]	●	●
	<b>Rear:</b> 1560 [61.4]	●	●
<b>Seating Capacity</b>	5	●	●
<b>Headroom</b>	<b>Front:</b> 1037 [40.8]	●	–
	<b>Rear:</b> 1008 [39.7]	●	–
	<b>Front:</b> 1002 [39.4] w/Moonroof	–	●
	<b>Rear:</b> 1008 [39.7] w/Moonroof	–	●
<b>Legroom</b>	<b>Front:</b> 1062 [41.8]	●	●
	<b>Rear:</b> 973 [38.3]	●	●
<b>Shoulder Room</b>	<b>Front:</b> 1450 [57.1]	●	●
	<b>Rear:</b> 1405 [55.3]	●	●
<b>Ground Clearance</b>	190 [7.5]	●	●

	Base 2WD	Sport 2WD	Limited 2WD
<b>CURB WEIGHT</b>			
	1524 [3360]	●	–
	1558 [3435]	–	●
	1560 [3439]	–	●
<b>TOWING CAPACITY</b>			
	680 [1500]	●	●
<b>PAYLOAD<sup>3</sup></b>			
	375 [825]	●	●
<b>CARGO CAPACITY</b>			
	2.074 [73.2] Behind Front Seats	●	●
	1.015 [35.9] Behind Rear Seats	●	●
<b>TURNING CIRCLE</b>			
	11.4 [37.4]	●	●
<b>FUEL CAPACITY</b>			
	60 [13.2]	●	●
<b>FUEL CONSUMPTION RATING<sup>2</sup></b>			
	City/Highway/Combined		
4-Cylinder	9.4/6.9/8.3	30/41/34	●







Yaris Hatchback



Camry Hybrid



RAV4



4Runner



Yaris



Prius



Highlander



Sequoia



Corolla



Venza



Highlander Hybrid



Tacoma



Matrix



Avalon



FJ Cruiser



Tundra



Camry



Sienna

Our Toyota dealers realize that building a lasting relationship is about more than just selling a vehicle. That's why our approachable staff is always happy to assist you, whatever your need may be. To find a Dealer nearest you, visit [toyota.ca](http://toyota.ca)



Toyota recognizes its duty to safeguard the environment. Please recycle.

