



DESIGN THE VOLVO THAT'S REALLY YOU. EXPERIENCE IT INSIDE AND OUT. LEARN ABOUT THE DETAILS, TECHNICAL FEATURES AND ACCESSORIES. SEE FILMS ABOUT YOUR FAVOURITE VOLVO AND ITS INNOVATIONS. COMPARE DIFFERENT VOLVO MODELS AND ENGINE ALTERNATIVES. JOIN THE VOLVO COMMUNITY AND SHARE GREAT CAR STORIES FROM ALL OVER THE WORLD. FIND YOURSELF AT WWW.VOLVOCARS.CA



www.twitter.com/Volvo_Canada



www.facebook.com/VolvoCarsOfCanada

Specifications, features, and equipment shown in this catalogue are based upon the latest information available at the time of publication. Volvo Cars of Canada Corp. reserves the right to make changes at any time, without notice, to colours, specifications, accessories, materials, and models. For additional information, please contact your authorised Volvo retailer. © 2011 Volvo Cars of Canada Corp. Printed in USA on 100% recyclable paper. **MY12C Cnd**



Mixed Sources
Product from well-managed
forests and other controlled sources
www.fsc.org Cert no. SA-COC-1393
© 1996 Forest Stewardship Council



VOLVO XC70

VOLVO
Volvo Car Corporation

www.volvocars.ca



An aerial, high-angle shot of a silver Volvo XC70 driving on a winding asphalt road. The road curves through a rugged, mountainous landscape with green vegetation and patches of snow. The car is in motion, with motion blur on the road surface and surrounding terrain. The sky is blue with some clouds. The car is positioned in the lower right quadrant of the frame, moving towards the upper left.

THERE'S MORE AROUND THE CORNER. THERE'S THE GREAT OUTDOORS. THERE'S THE DAILY ROUTINE. THERE'S RAIN, SNOW, SLEET, SUN, DUST AND DIRT. THERE'S YOU, YOUR FAMILY, YOUR FRIENDS AND A THOUSAND REASONS TO GET TO ANY PLACE YOU NEED TO WITH POWER, REFINEMENT, VERSATILITY AND STYLE. THEN THERE'S YOUR CAR. LIFE ISN'T ABOUT LIMITATIONS. IT'S ABOUT LIVING. THAT'S WHY YOU WANT TO DRIVE THE REFINED XC70.



In the space of a few hours, pristine mountain landscapes can be replaced by downtown traffic. Some cars might find such a journey traumatic. Not the XC70. Advanced technology such as Adaptive Cruise Control with Queue Assist* (at all speeds) ensures that wherever life takes you, your XC70 won't utter a single word of complaint.

* Included in the optional Technology Package



You're invited to explore new roads and new destinations. Inside and out, the refined Volvo XC70 is designed around you as driver. Here, superior all-road and all-weather performance combines with iconic comfort and state-of-the-art supportive technology to encourage any escape. This is pure Scandinavian design that lives any way you choose.



A CAR WITH A MISSION - YOUR MISSION.

We designed the XC70 with one single purpose - to empower you and your desire to drive. So we endowed it with numerous innovative features, like Hill Descent Control. Simply at the push of a button, this offers smooth, controlled and safe descents on steep, rough roads. The system controls braking on each wheel, allowing you to concentrate fully on steering. Away from the wilderness, Hill Descent Control also makes it easier to move off when towing a heavy trailer. The rest of the time you'll enjoy the benefits of an advanced chassis and Volvo's All-Wheel Drive* (AWD) with Instant Traction™. You'll find that stability and handling together with 210 mm ground clearance are at your side - no matter the road, weather or mission at hand.

* Optional XC70 3.2



THE METICULOUS ATTENTION TO DETAIL INCLUDES THE ROAD AHEAD.

This Volvo is intelligence at work. The Technology Package* contains advanced technology to help you deal with traffic the best possible way for you and other road users – including pedestrians. Radar and digital camera technology interacts with on-board intelligence (including your own, of course) to constantly monitor vehicles and pedestrians ahead, to help you keep a safe distance from other vehicles and to alert you if you are distracted or unintentionally weave out of your lane. A push of a button, and you can enjoy smooth cruising at all speeds – whether travelling in stop-and-go city traffic or crossing continents. And if there is a risk of collision the technology will warn you and – if you don't react – apply full braking force to help prevent a collision. Having all this additional intelligence turns any journey or commute into an extrasensory experience. To see this supportive technology in action, please visit www.volvocars.ca

* Optional



LANE DEPARTURE WARNING

DRIVER ALERT CONTROL

COLLISION WARNING WITH FULL AUTO BRAKE

PEDESTRIAN DETECTION WITH FULL AUTO BRAKE

ADAPTIVE CRUISE CONTROL WITH QUEUE ASSIST AT ALL SPEEDS

**CITY SAFETY.
MASTERING THE UNEXPECTED
WITH LASER PRECISION.**

Always expect the unexpected – nowhere is this more evident than in urban traffic. That's why the advanced low-speed collision avoidance system City Safety comes as standard in your Volvo. Utilising laser technology and active up to 30 km/h, this high-precision system keeps a lookout on the road 6–8 metres ahead. If a vehicle suddenly brakes in front of you and a collision is imminent, City Safety will intervene and brake automatically to help avoid or mitigate a collision. Very courteous in slow-moving city traffic – for you, your passengers, your insurance company and anyone in the car in front of you. almost like a sixth sense tuned into the city. Sounds like simple common sense to us – which perhaps explains why you'll find it in a Volvo.





AT LAST, A CAR THAT CAN SEE THE FUTURE.

Drive a Volvo and you'll experience insightful control. Here, supportive technology acts to redefine the pleasure of driving and even predict what's around the corner. For example, the Pedestrian Detection with Full Auto Brake* is a Volvo world first that constantly scans the road ahead for pedestrians. If it detects pedestrians at risk, a heads-up display warning will flash and an alarm will sound while the brakes prepare to optimise braking performance. And if you don't react to the warning, full auto braking will be deployed to help keep the pedestrian out of harm's way. This is truly visionary technology for your support and another foresighted innovation by Volvo.

* Included in the optional Technology Package

THE PERFECT PACE AT ANY SPEED.

Relax and enjoy smooth cruising. The new generation Adaptive Cruise Control (ACC)* with Queue Assist goes beyond ordinary cruise control by automatically helping you maintain a safe distance to the car in front. Controlled by advanced radar and camera technology, the ACC detects slower moving vehicles ahead and adapts your speed accordingly. And that's at any speed – whether in heavy traffic queues or at open-road speeds (0–200 km/h). It can even help you keep pace with the car in front from standstill, which can be very convenient in stop-and-go traffic. Having this additional functionality can help save you from the most boring parts of any journey or commute. In this way you can just find your perfect pace through traffic.

* Included in the optional Technology Package





THE SWEETNESS OF CONTROL.

In a Volvo, there's no doubt who's in command. Everything – from the ergonomic seat design to the advanced driver-control interface – has been created with one single purpose: to give you, as driver, the best imaginable support for an inspiring and relaxed drive. To achieve this, control is essential. That's why we designed the new driver-control interface, Volvo Sensus, as an intuitive command centre. Complete control is at your fingertips. With an integrated thumb scroll on the steering wheel, you have full control of the car and all in-car entertainment, navigation*, park assist camera* and Bluetooth® communication systems – with both hands on the steering wheel. All information is neatly displayed on the standard in-dash 7" hi-resolution colour screen. And by adding Volvo's innovative front blind view camera**, a revealing 180-degree field of view is displayed in the screen to help you negotiate blind intersections. Convenient, smart and definitely high-tech – never before has total control been so easy to achieve.

* Optional
** Accessory

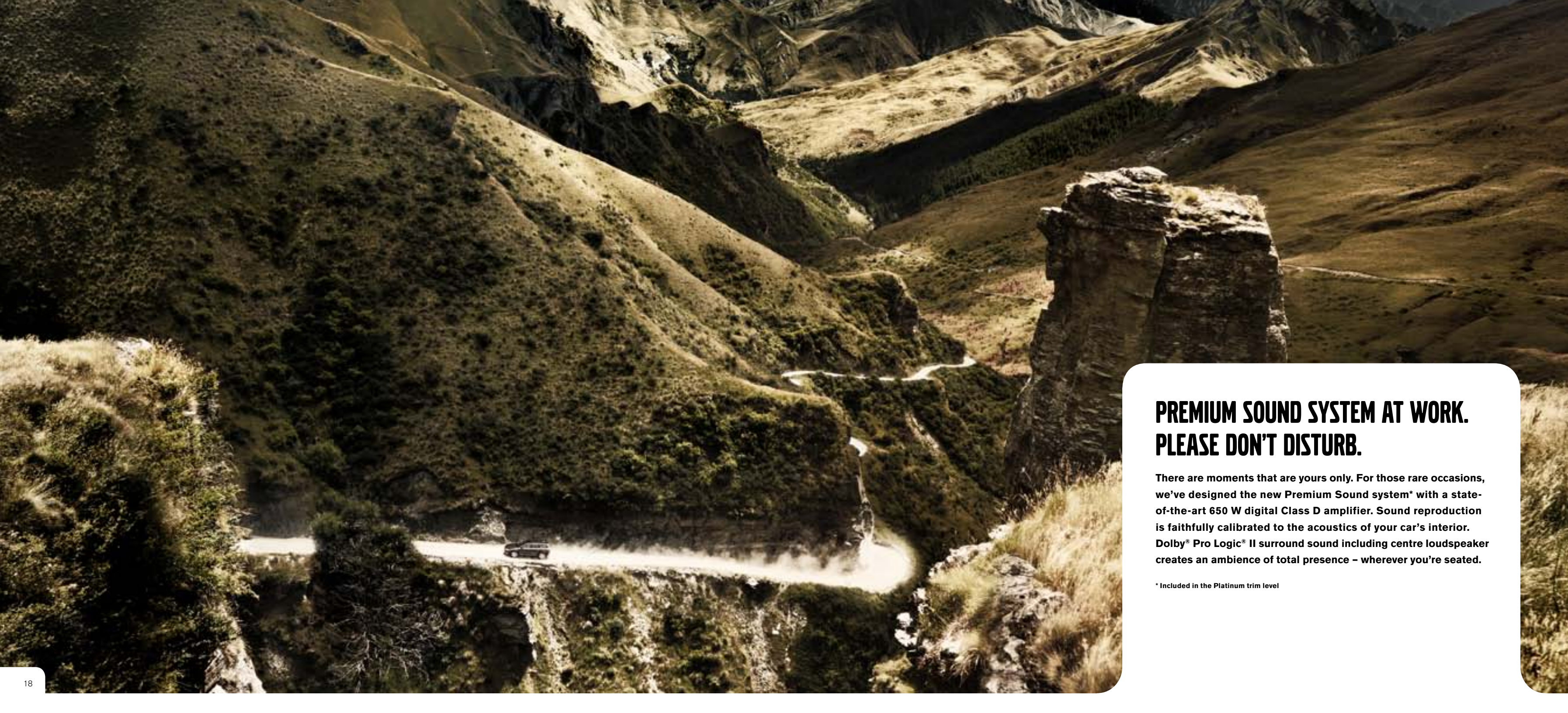

PREMIUM SOUND SYSTEM AT WORK. PLEASE DON'T DISTURB.

There are moments that are yours only. For those rare occasions, we've designed the new Premium Sound system* with a state-of-the-art 650 W digital Class D amplifier. Sound reproduction is faithfully calibrated to the acoustics of your car's interior. Dolby® Pro Logic® II surround sound including centre loudspeaker creates an ambience of total presence – wherever you're seated.

* Included in the Platinum trim level



INTELLIGENT SECURITY, AT YOUR SERVICE 24/7.

Park your Volvo and the sense of wellbeing doesn't cease. With the Keyless Drive Personal Car Communicator,* you can check the security status of your car from a distance (of up to 100 metres) and, on your return, your Volvo lets you unlock the doors with a grasp of a handle and start your car without a key in hand – it's enough to have the key in your pocket or handbag.

* Included in the Premium Plus and Platinum trim level or as a stand alone option

INNOVATED FOR YOUR ENJOYMENT, THE VOLVO TECHNOLOGIES WILL PROTECT MORE THAN THE FUN OF DRIVING.

Across the world, Volvo equals safety. And that comes with good reason, because few carmakers can match our record of safety innovations and the commitment for safety that has guided us for more than 80 years. Of course, this makes us extremely proud. But we're not satisfied. Because we know what we want to achieve: zero accidents. This vision calls for innovative thinking and a brand new approach to the way we design cars. Good news is we've already come a long way. For starters, our cars are more fun and engaging to drive than ever (because a bored driver will never be a safe driver). Neither is the technology needed any figment of the imagination – some are already available. This means driving a Volvo today is like having a first peek at a very exciting automotive future – a future where passionate engineering and design do more to help you get the most out of life.

After all, there's more to life than a Volvo.

PERSONAL GATEKEEPING.

Inspired by fighter aircraft technology, the Intelligent Driver Information System (IDIS) can help reduce your workload in stressful situations.

STAY ON TRACK.

Volvo's anti-skid system Dynamic Stability and Traction Control (DSTC) improves handling and safety in a wide range of challenging situations.

ALL-ROAD STABILITY.

Volvo's All-Wheel Drive (AWD)* with Instant Traction™ enhances driving stability and traction in all weathers, all seasons and on all roads.

*Standard on T6

EYES IN THE BACK.

The Rear Park Assist Camera* can let you know what's going on behind your car when reversing

*Included in the Platinum trim level

STAYING ALERT.

Driver Alert Control* alerts you if you begin to lose concentration and need a break.

* Included in the optional Technology Package

AN EYE ON THE BLIND SPOT.

The optional Blind Spot Information System (BLIS) helps you detect vehicles entering your blind spot.

POSITION CONTROL.

Lane Departure Warning* warns you if you begin to drift between the lanes.

* Included in the optional Technology Package

ON-ROAD ENLIGHTENMENT.

The optional Active Bending Lights with Dual Xenon technology expands your vision range when driving in the dark and provides considerably improved illumination around bends.

KEEPING A SAFE DISTANCE.

Collision Warning with Full Auto Brake* warns if you're too close to a vehicle and helps brake the car automatically if a collision is imminent.

* Included in the optional Technology Package

SMOOTH CRUISING.

Adaptive Cruise Control* with Queue Assist automatically maintains your set speed and distance to the vehicle ahead of you.

* Included in the optional Technology Package



DESIGNED TO CATCH THE LIGHT BRILLIANTLY, THIS CAR ALSO REFLECTS A PROMISE.

Thankfully, the automotive industry is moving away from fantasyland to the real world. Our journey towards a better environment started already in the early 70's. Then we were among the first carmakers to acknowledge the environmental downside of cars and to do something about it. Since then we are constantly innovating to reduce the environmental impact of the cars and how we make them.

In the near future we will introduce new technology such as plug-in hybrid vehicles that will further reduce CO₂ emissions and can be charged from a standard wall socket. And we're heavily engaged in the development of electrical vehicles – a technology that will dramatically reduce the environmental footprint of our cars and make them even more fun to drive.

Good for you, and for the world we share.



FUEL-SAVING DESIGN.

To reduce energy-losses from wind and roll resistance, we utilise advanced aerodynamic design, light-weight materials and low friction technology. Together with state-of-the-art engine technology, this lowers your CO₂-emissions and helps you travel further on fuel.

CLEANER EXHAUST.

Fast responding after a cold start, Volvo's advanced emission control eliminates between 95 and 99% of carbon monoxide, hydrocarbons and nitrogen oxides from engine exhaust gases.

BRAKE FOR ENERGY.

Everytime you brake, the battery is fed with extra power. Smart and fuel-saving.

ALLERGY-TESTED INTERIOR MATERIALS.

All our upholsteries and interior textiles are tested for certain allergy-inducing or harmful substances. And several interior metal details are tested with regard to contact allergies. Good for you, and for anyone who shares your ride.

FRESH CABIN AIR.

Continuously monitoring incoming air and shutting out carbon monoxide, ground-level ozone and nitrogen dioxide, Volvo's optional Interior Air Quality System helps ensure that the air you breathe in the car is cleaner than that outside when driving in heavy city traffic.

85% RECYCLABLE.

To help minimise its total environmental impact, every Volvo is designed to facilitate recovery and recycling at the end of its useful life.



WANT A DYNAMIC TOUCH?

If stylish and sporty looks get your pulse racing, this may be the Volvo XC70 for you: This XC70 T6 is shown in Ice White with an Offblack leather interior, colour matched accessory roof spoiler, accessory side scuff plates and Zepherus 18" Diamond cut/ Anthracite matt aluminium alloy wheels.



OR MODERN LUXURY?

Some people prefer sophisticated, timeless elegance. If that sounds like you, your new Volvo XC70 with the Premier Trim level can look like this: Soft Beige leather upholstery in Sandstone Beige interior with Classic walnut wood centre stack and door panel inlays. The exterior colour is Caspian Blue metallic with standard Cecino Silver Bright aluminium alloy wheels.



CHOOSE YOUR VOLVO XC70.

As you define your own style and specify your needs, there's a range of equipment levels, factory installed options and accessories that can help reflect your taste or simplify your tasks. Find your personal Volvo at www.volvocars.ca

XC70 TRIM LEVEL:

PREMIER

(3.2 only)

- Leather Seating Surfaces
- Power Glass Moonroof
- Power Passenger Seat
- Classic Walnut Wood Inlays
- Tinted Rear Seat and Cargo Area Windows

PREMIER PLUS

- Power Operated Tailgate with Programmable Memory Setting
- Keyless Drive with Personal Car Communicator (PCC)
- Park Assist, Front & Rear
- HomeLink® Integrated Garage Door Opener
- Digital Compass
- Cargo Cover
- Grocery Bag Holder
- 12V Power Outlet in Cargo Area
- Electric Folding Rear Headrests
- Private Locking
- Leather Seating Surfaces*
- Power Glass Moonroof*
- Power Passenger Seat*
- Classic Walnut Wood Inlays*
- Tinted Rear Seat and Cargo Area Windows*

* Standard T6

PLATINUM

- Navigation System with Voice Control and Map Care
- Volvo Premium Sound System
- Rear Park Assist Camera
- Power Operated Tailgate with Programmable Memory Setting
- Keyless Drive with Personal Car Communicator (PCC)
- Park Assist, Front & Rear
- HomeLink® Integrated Garage Door Opener
- Digital Compass
- Cargo Cover
- Grocery Bag Holder
- 12V Power Outlet in Cargo Area
- Electric Folding Rear Headrests
- Private Locking
- Leather Seating Surfaces*
- Power Glass Moonroof*
- Power Passenger Seat*
- Classic Walnut Wood Inlays*
- Tinted Rear Seat and Cargo Area Windows*

* Standard T6

OPTIONAL PACKAGES:

CLIMATE PACKAGE

- Heated rear seats (N/A with booster seats)
- Heated windshield washer nozzles
- Headlight washers
- Interior Air Quality System (IAQS)
- Rain sensor

TECHNOLOGY PACKAGE

- Adaptive Cruise Control with Queue Assist
- Collision Warning with Full Auto Brake
- Distance Alert
- Driver Alert Control
- Lane Departure Warning
- Pedestrian Detection with Full Auto Brake

STANDARD FEATURES

| SAFETY | 3.2 AWD | T6 AWD |
|---|---------|--------|
| ABS Anti-lock Brakes | ● | ● |
| Anti-submarine seats | ● | ● |
| AWD with Instant Traction | ○ | ● |
| City Safety | ● | ● |
| Daytime running lights | ● | ● |
| Driver and front passenger supplemental restraint system (SRS) – multi-threshold air bags | ● | ● |
| Dynamic Stability and Traction Control (DSTC) | ● | ● |
| Electric Parking Brake | ● | ● |
| Hill Decent Control (AWD only) | ○ | ● |
| Intelligent Driver Information System (IDIS) | ● | ● |
| Illuminated side marker lights/turn signal indicators | ● | ● |
| Immobilizer, encrypted ignition key | ● | ● |
| Inflatable side curtain (IC) | ● | ● |
| ISOFIX baby/child seat attachment system | ● | ● |
| Rear fog light with auto-off | ● | ● |
| Safe approach and home safe lighting | ● | ● |
| Seat belts: five, 3-point inertia-reel belts with automatic pretensioners; front belts have height adjustment | ● | ● |
| Seat belt reminder | ● | ● |
| Security system | ● | ● |
| Side impact air bags for driver and front passenger (SIPS bags IITM) | ● | ● |
| Side impact protection system (SIPS) | ● | ● |
| Top-tether child seat anchorage capability | ● | ● |
| Whiplash protection seating system (WHIPS) | ● | ● |
| INTERIOR | | |
| Auto Dimming Rearview Mirror | ● | ● |
| Bluetooth® handsfree system with streaming audio | ● | ● |
| Central power door locks with remote control, tailgate and fuel filler door locks | ● | ● |
| Classic Walnut Wood inlay | N/A | ● |
| Cruise control | ● | ● |

| | 3.2 AWD | T6 AWD |
|---|---------|--------|
| Cup holders (8) | ● | ● |
| Dual-zone electronic climate control (ECC) | ● | ● |
| Five padded head restraints | ● | ● |
| Four reading lights | ● | ● |
| Front centre armrest | ● | ● |
| Front door-panel storage pockets | ● | ● |
| Front seat-back storage pockets | ● | ● |
| High Performance Audio System with In-dash CD 8 speakers | ● | ● |
| Illuminated lockable glove compartment | ● | ● |
| Illuminated vanity mirrors in driver/front passenger sun visors | ● | ● |
| Interior cabin light delay | ● | ● |
| Leather-clad steering wheel | ● | ● |
| Leather-clad gear lever knob | ● | ● |
| Leather Seating surfaces | ○ | ● |
| Luggage/cargo area lights | ● | ● |
| Outside temperature gauge | ● | ● |
| Power-adjustable driver seat, 8-way with 3-position memory and lumbar support | ● | ● |
| Power Glass Moonroof | ○ | ● |
| Power Passenger seat | ○ | ● |
| Power windows with driver and passenger auto up/down with anti-trap feature | ● | ● |
| Rear seat ventilation outlets on B-pillar | ● | ● |
| Rear window defroster with automatic timer | ● | ● |
| Tilt/telescopic steering wheel with illuminated cruise and audio controls | ● | ● |
| Two entry lights (in front door footwells) | ● | ● |
| USB/iPod® and AUX input | ● | ● |
| Volvo Sensus with 7" hi-resolution screen | ● | ● |
| Watch Dial Instruments | N/A | ● |
| XC Seat and door panel stitching | ● | ● |
| 12-volt power outlet | ● | ● |
| 40/20/40 split-flat folding rear seat | ● | ● |

| EXTERIOR | 3.2 AWD | T6 AWD |
|---|---------|--------|
| Dual Exhaust End Pipes | N/A | ● |
| Front and rear skid plates | ● | ● |
| Front fog lights | ● | ● |
| Power-adjustable heated exterior rearview mirrors | ● | ● |
| XC Body trim | ● | ● |
| XC Grille | ● | ● |
| XC Roof rails | ● | ● |
| 16" Cecino alloy wheels | ● | N/A |
| 18" Zephyrus alloy wheels | ○ | ● |

 The Bluetooth word mark and logos are owned by the Bluetooth SIG, Inc. and any use of such marks by Volvo Car Corporation is under license. Other trademarks and trade names are those of their respective owners.



INDIVIDUAL OPTIONS

| EXTERIOR | 3.2 AWD | T6 AWD |
|---|---------|--------|
| All Wheel Drive with Instant Traction | ○ | ● |
| Blind Spot Information System (BLIS) | ○ | ○ |
| Dual-stage Child booster seats and power child locks | ○ | ○ |
| Dual Xenon Headlights with Active Bending Light (ABL) | ○ | ○ |
| Keyless Drive with Personal Car Communicator (PCC) | ○ | ○ |
| Metallic paint | ○ | ○ |
| Navigation preparation | ○ | ○ |
| Sirius Satellite radio includes 6 month subscription | ○ | ● |
| 18" Zephyrus alloy wheels | ○ | ● |

● = Standard ○ = Option N/A = Not available

EXTERIOR DESIGN

The XC70's muscular yet lean design characteristics can both seduce and deceive. Its seductive nature is obvious. Horizontal lines give the car a wide, low look while the vertical design qualities have been emphasized to create a tough, rugged and stable impression.

As for deceptive, we were referring to load capacity. And in the case of the XC70, this is anything but lean. The XC70 is also a blank page on which you can write your own personal signature by adding side scuff plates, aluminium crossbars, a roof spoiler or any one of many other eye-catching Volvo accessories.

Side scuff plate

The matt aluminium finish side scuff plates add an extra touch of attitude to the Volvo XC70 – perfectly matching the design of the sill and other XC70 exterior styling details.

Aluminium crossbars

An aerodynamic design element that complements the roof rails and the design of your Volvo. These aluminium crossbars also allow you to exploit the roof's load-carrying capacity to the full.

Roof spoiler

The stylish roof spoiler enhances the sporty lines of your Volvo estate and is colour-coordinated with the body.



EXTERIOR DESIGN Aluminium wheels



Zephyrus 7.5x18"
Diamond cut/Anthracite matte
(standard T6 AWD, optional 3.2)



Cecino 7x16"
Silver Stone
(standard 3.2)

Please note: Not all wheels can be combined with all engine variants. Please talk to your Volvo dealer for more information.



COLOUR YOUR VOLVO.

When it comes to the appearance of your Volvo, the choices of exterior colour and wheels are probably your most important design decisions. For more exterior styling options and to build your new Volvo online, please visit www.volvocars.ca



614 Ice White



477 Electric Silver Metallic



702 Flamenco Red Metallic



484 Seashell Metallic

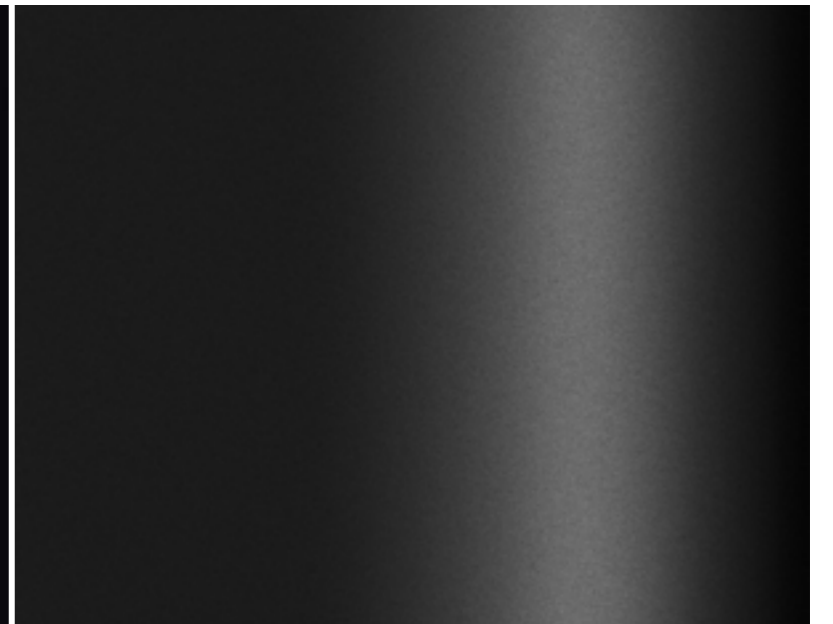

700 Twilight Bronze Metallic

498 Caspian Blue Metallic

452 Black Sapphire Metallic

019 Black Stone

Please note: It's not possible to reproduce exact original shades in printed matter. Please ask your dealer to show you samples.

INTERIOR DESIGN



Offblack leather upholstery in Anthracite black interior (F101)
Classic wood trim centre console and door panel inserts (standard T6, 3.2 Premier trim)

Sandstone Beige leather upholstery in Sandstone Beige interior (F112)
Classic wood trim centre console and door panel inserts (standard T6, 3.2 Premier trim)



Offblack Textile upholstery in Anthracite interior (F501)
Cross Avenue aluminium trim centre console and door panel inserts (standard 3.2)

Espresso Brown leather upholstery in Sandstone Beige interior (F116)
Classic wood trim centre console and door panel inserts (standard T6, optional 3.2)



Leather-clad steering wheel,
Offblack with Silk metal inlay



Leather-clad steering wheel,
Sandstone with Silk metal inlay



Leather-clad gear knob
Offblack, Geartronic



Leather-clad gear knob
Sandstone Beige, Geartronic



Cross Avenue aluminium trim
(standard 3.2)



Classic wood trim
(standard T6 and 3.2 Premier Trim)

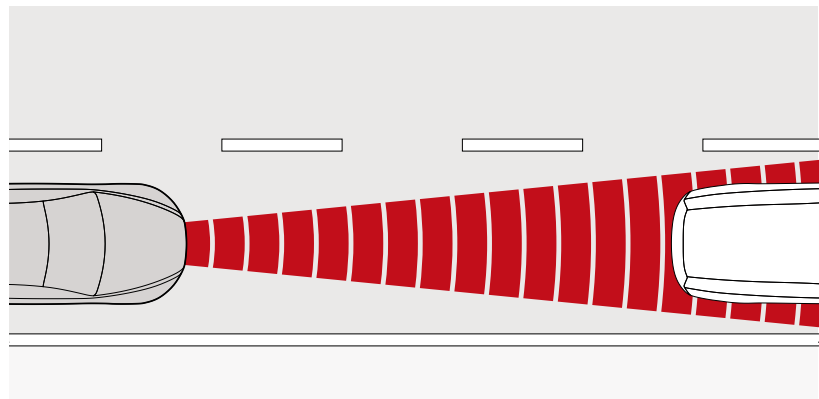

Adaptive Cruise Control (ACC) with Queue Assist

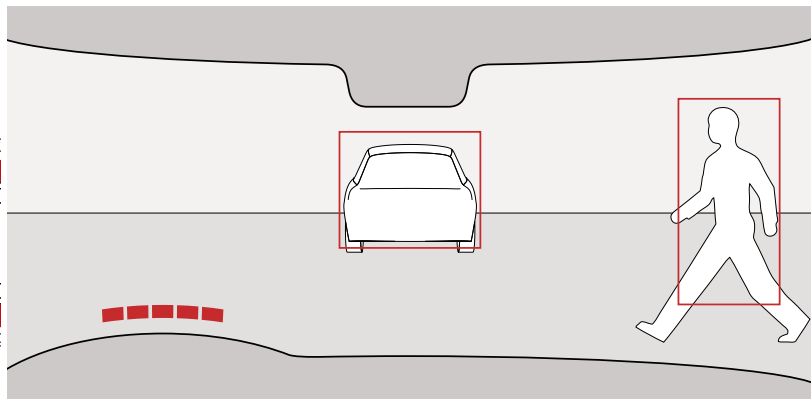

Collision Warning and Pedestrian Detection with Full Auto Brake

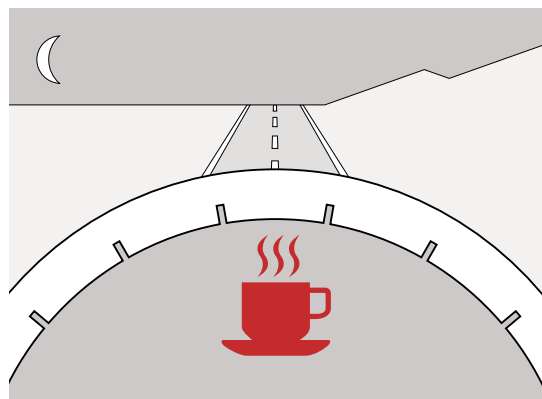

Driver Alert Control (DAC)

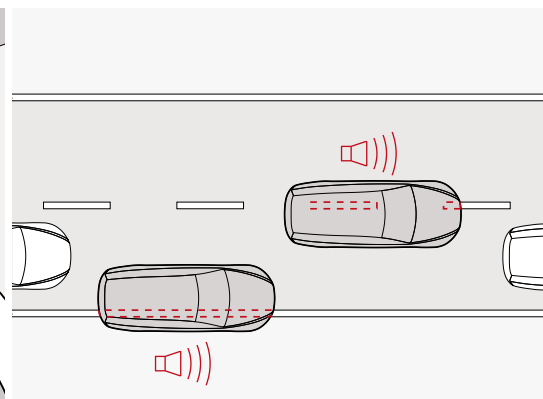

Lane Departure Warning (LDW)

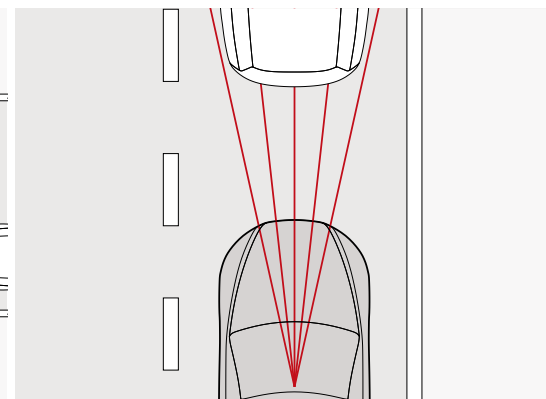

City Safety

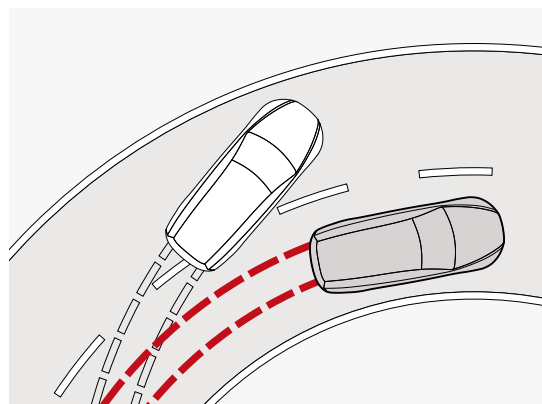

Dynamic Stability and Traction Control (DSTC)

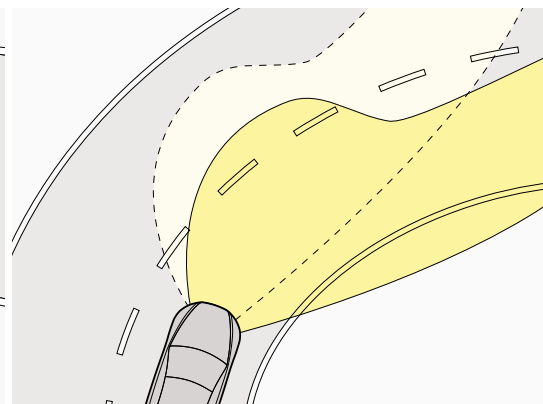

Dual Xenon Headlights with Active Bending Lights (ABL)



Adaptive brake light

SAFETY

SAFETY Preventive

Adaptive Cruise Control (ACC) with Queue Assist*

Helping the driver to keep a safe distance from vehicles in front at all speeds up to 200 km/h, this third-generation ACC is a supportive partner for a more relaxed driving experience on any journey. In slow-moving city traffic, the ACC stop and go function automatically adapts your speed to the vehicle in front. From standstill, a press of a button or the accelerator is all it takes to make your car smoothly tail the vehicle in front. At speeds over 30 km/h, just select the desired speed and the minimum time gap to the vehicle in front. When the radar sensor detects a slower vehicle in front, the speed automatically adapts to that vehicle. And when the road is clear, the car resumes the selected speed. If ACC is disengaged and a vehicle in front comes too close, the distance alert function activates a warning light in the lower section of the windscreen to help you keep the proper distance.

* Included in the optional Technology Package

Collision Warning and Pedestrian Detection with Full Auto Brake*

Statistics show that in 50% of the rear end collisions the driver at fault doesn't brake at all. Active at all speeds above 4 km/h, this third-generation collision avoidance technology can warn you if you're too close to a vehicle in front or if there are pedestrians in your path. If you don't react and a collision is imminent, full auto-braking is engaged to help you avoid or mitigate an impact. Within a range of 150 metres, a radar sensor continuously monitor the distance to the vehicle in front of you. During daylight it can also detect standing or moving pedestrians. If a pedestrian unexpectedly steps out in front of your car or if a vehicle suddenly brakes (or is stationary) and Collision Warning senses that a collision is likely to happen, it will alert you to act with a flashing warning light on the windscreen along with an audible alarm. Moreover, this technology supports driver-initiated braking by pre-charging the brakes to quickly prepare for panic braking and help reduce the reaction time. If you don't react to the warning and a collision is imminent, the car immediately brakes with full braking force.

* Included in the optional Technology Package

Driver Alert Control (DAC)*

Up to 90% of all traffic accidents are caused by driver distraction. Driver Alert Control is a unique technology that can help alert a tired or distracted driver at speeds over 65 km/h. Using signals from a digital camera to monitor the road ahead along with data from steering wheel movements, DAC can compare erratic behaviour to your normal driving style. If DAC detects that you begin to drift within your lane, you receive an audible warning. At the same time, a message is displayed in the instrument panel suggesting it might be time for a break.

* Included in the optional Technology Package

Lane Departure Warning (LDW)*

At speeds over 65 km/h, Lane Departure Warning can help prevent single-vehicle road departures as well as collisions caused by temporary distraction. This function uses the digital camera to register the lane markings and help monitor the car's position on the road. If you weave out of your lane, LDW will alert with an audible signal. If you intentionally cross a lane marker using the direction indicators, LDW is not activated.

* Included in the optional Technology Package

City Safety

City Safety collision avoidance technology is a Volvo world-first standard feature for safer urban driving. At speeds up to 30 km/h, this laser-based technology can sense if a vehicle in front within 6–8 metres is at a standstill or is moving slower. If City Safety senses an impending collision, the brakes are pre-charged to act faster on your response. And if you don't brake, City Safety automatically applies the brakes and switches off the throttle to help you avoid or mitigate a collision. City Safety is activated when you start the car, but can be switched off if you, for instance, are driving in deep snow.

Dynamic Stability and Traction Control (DSTC)

By helping prevent fishtails, spinouts, and rollovers, stability control technology like DSTC has been described as one of the most vital safety advances of the past decade. At the core of DSTC, a gyroscope senses the car's direction and compares this with steering wheel movements as well as the actual rotation of the car's wheels. DSTC is able to detect a potential skid and help counteract this by reducing the engine's power output, or braking on one or more wheels.

Intelligent Driver Information System (IDIS)

To help avoid distractions during critical driving situations, IDIS constantly analyses your driving and will delay secondary information from the car or one of its onboard systems – such as the GSM phone – when it detects intense steering, braking or acceleration. As soon as things calm down, the phone call or the delayed information is presented. IDIS can be set up to let GSM calls through in all driving situations.

Dual Xenon Headlights with Active Bending Lights*

In addition to improving illumination by using Dual Xenon light technology, the Active Bending Lights give a boost to your vision round bends at night. Controlled by microprocessors, the motorised lamps turn up to 15 degrees in either direction when driving – reliably lighting up your chosen path. A twilight sensor disengages the adaptive function during daylight to extend its life span.

* Optional

Adaptive brake light

Active at speeds above 50 km/h, the adaptive brake light can sense the difference between normal and panic braking. If it is a panic situation, all the brake lights will flash at a rate of four times per second. Once your speed slows to below 10 km/h, the lights stop flashing and hazard lights flash instead.



Volvo's interactive safety technologies



Restraint technologies



Inflatable Curtain (IC)



Whiplash Protection System (WHIPS)

SAFETY

SAFETY Protective

Volvo's interactive safety technologies

In a Volvo, safety is about interaction. Because it's not the number of safety features that determines how safe a car is, it's how well they seamlessly interact to help protect the occupants in the event of a collision.

IN A REAR IMPACT the rear deformation zones will help absorb crash energy. The fuel tank is designed to remain well protected in front of the rear axle. The head restraints help protect the neck and spine, and Volvo's unique Whiplash Protection System (WHIPS) cradles the front seat occupants in a controlled manner to help prevent whiplash injuries.

IN A SIDE IMPACT Volvo's unique Side Impact Protection System (SIPS) helps distribute the crash forces across the car's body, away from the occupants. The dual-chamber side airbags in the front seats help protect the chest and hip, while the Inflatable Curtain (IC) adds head protection.

IN A ROLL-OVER the robust safety cage and the reinforced roof structure together with the safety belts and belt pretensioners will help protect the occupants. If the car first has been hit from the side, the Inflatable Curtain (IC) deploys to help provide head protection.

IN A FRONTAL COLLISION the patented frontal structure will yield to help absorb and disperse crash energy. The compact power train is designed to help optimise deformation. Inside the car, safety belts interact with the collapsible steering column and dual-stage airbags to help keep the occupants out of harm's way. A lower cross member helps protect occupants in an oncoming car with lower positioned bumpers.

Restraint technologies

In a collision, Volvo's restraint technologies interact to help reduce the impact. The **safety belts with pre-tensioners** activate within a few thousandths of a second in the event of a collision and tighten the belt to help keep the occupants securely restrained. The front seat safety belts then release a little so that the driver and passenger are cushioned by the airbags in a controlled manner. Helping to optimise protection, the **dual-stage airbags** adapt the level of inflation depending on the force of the collision. The driver's airbag also interacts with the deformation of the collapsible steering column.

Dual-chamber side airbags in the front seats help reduce the risk of serious injuries in a side collision. Two separate chambers are inflated at different pressures to help optimise protection of the chest and hip on the front seat occupants. The **Inflatable Curtain (IC)** helps protect the heads of both front and rear outboard occupants. It also stays inflated for some seconds to provide prolonged protection for subsequent impacts. And to help protect children in the rear seat, IC interacts with the two-stage integrated booster cushions and the belt load limiters..

Whiplash Protection System (WHIPS)

Integrated in the front seats, Volvo's WHIPS cradles the occupant to help reduce the risk of whiplash injury (one of the most common types of traffic injury and often the result of a low-speed rear impact collision). The function is activated by a collision of sufficient force from behind. Independent research has shown that WHIPS is one of the most effective systems in the world and can reduce the risk of long-term invalidity by 50%.

Energy-absorbing frontal structure

In developing this Volvo's protective qualities, we have focused on frontal collisions at both higher speeds and with heavier vehicles. The patented frontal structure with its sizeable deformation zones in different kinds of steel will yield to help absorb crash energy. The compact power train is designed to help optimise deformation. The unique geometry of the frontal structure and longitudinal steel struts in the doors help disperse crash energy away from the front to the rear of the car, further helping to reduce the strain on the occupants. A steel strut under the dashboard further helps keep the cabin intact.

Side Impact Protection System (SIPS)

SIPS is a Volvo unique safety system that has been developed to help protect where occupants are most exposed to the crash forces. The steel framework of the car – including the front seats – is designed and reinforced to help displace the impact of a side-collision away from the occupants to other parts of the car body and help prevent intrusion into the cabin. The extremely strong side structure is built-up with ultra-high strength steel and softer grades of steel to help withstand a severe side impact – even with a larger vehicle. The Inflatable Curtain (IC) for all the outboard occupants and the front seat dual-chamber side airbags interact to help provide further protection. In the rear seat, the combination of extended IC and Volvo's integrated two-stage booster cushion with progressive safety belt load limiters helps protect children.



Your car is locked.

Your car is unlocked.

The alarm has been triggered.

Press here to see the actual status of your car (within a range of 60–100 m) or the car's status when you left it (outside the range).

Keyless Drive with Personal Car Communicator (PCC)



HomeLink®



Power retractable door mirrors with ground lighting



Ergonomic design

Adjustable lumbar support

Integrated coat hanger

Multiple adjustment possibilities

Front pocket



Power front seats



Power glass moonroof



Front centre armrest, multifunctional



Sun glass holder

SAFETY

SAFETY Security

Keyless Drive with Personal Car Communicator (PCC)*

The optional PCC is an advanced remote control that combines keyless drive with two-way communication with your Volvo. Keep the PCC with you and the car unlocks automatically as you pull the door handle. Start the engine by pressing a button on the dash, lock the car by pressing a button in the door handle. Later in the day, if you're wondering whether you've locked the car, PCC can remind you; no matter where you are. On your return to the car – within a radius of 60 to 100 metres – pressing the PCC information button will give you a current report on its status. If the alarm has been activated.

* Included in the Premier Plus trim level, available as a stand alone option

HomeLink**

With buttons integrated in the sun visor, HomeLink® allows you to operate remote controlled home appliances – such as garage door, home alarm and exterior lighting – without leaving the car.

HomeLink is a registered trademark of Johnson Controls Technology Company.

* Included in the Premier Plus trim level

Power retractable door mirrors with ground lighting*

At the touch of a button, these door mirrors can be folded flat against the car where they are less likely to get damaged after you've parked. They also fold or unfold automatically every time you lock or unlock the car. The integrated ground lighting is activated with the remote control or with the PCC. Beyond enhancing security to and from your car at night, this is also convenient when getting in and out.

* Included with the optional Blind Spot Information System BLIS

Approach and Home Safe Lighting

Activated with the remote control or Personal Car Communicator, Approach Lighting provides a warm reception on a dark night. This consists of interior and side lights – ground lighting too, if you choose it. Home Safe Lighting is activated with the headlight stalk as you leave the car and it provides a similar courtesy when exiting your car. This feature includes a dipped beam from the headlight to accompany you to your door.

Lockable floor

To further foil smash and grab burglaries, the closed tailgate – just by the function of its design – overlaps and seals the compartment hidden under the cargo floor. To keep this private storage area inaccessible to other users of the car, e.g., valet parking, you can include the tailgate when setting your private locking preferences.

COMFORT

COMFORT Seats

Power front seats*

Find your perfect driving position with push-button ease. The driver's seat also incorporates a memory function that stores three separate seat and door mirror settings connected to a specific remote control – a feature that's appreciated when the car has several drivers.

* Driver power seat standard. Power passenger seat included with Premier trim level

Heated front seats*

Adjustable in three settings, heated seats for the driver and front seat passenger add to comfort on those cold mornings.

* Included in the optional Climate Package

COMFORT Climate

Power glass moonroof*

This makes the interior feel extra light and airy. It opens and closes at the touch of a button. If the sun is too strong, just close the built-in sun screen. The moonroof can also be closed together with the side windows using the central locking remote control.

* Included in the Premier trim level

Electronic Climate Control (ECC)

Electronic Climate Control (ECC) maintains the cabin temperature you choose and can be set independently for the driver and front passenger. Further contributing to your health and comfort, Volvo's unique humidity sensor helps ensure cabin air has an appropriate level of humidity according to the outside climate.

Interior Air Quality System (IAQS)*

Volvo's IAQS continuously monitors incoming air and will, if necessary, temporarily close external air vents to shut out carbon monoxide, ground-level ozone and nitrogen dioxide. Meanwhile, an active carbon filter protects the occupants from other harmful gases and unpleasant odours. This helps to ensure that the air you breathe in the car is cleaner than that outside when driving in heavy city traffic and tunnels.

* Included in the optional Climate Package

COMFORT Storage

Front centre armrest, multifunctional

The central aisle of the cabin incorporates several facilities. Two cup holders are concealed by a roll-top cover. There's a handy storage space beneath the armrest, and special recesses for small items. Folding back the upper part of the armrest will provide a convenient table for the rear seat passengers. The armrest also features an AUX input and – depending on your choice of audio system – a USB/iPod® port to connect your MP3 player to the car's audio system.

Sun glass holder*

Fitted in place of any of the entry grab-handles in the front, this holder keeps your glasses or sun glasses within reach. Simply press the oil-damped cover and it opens up.

* Retailer installed accessory



Volvo Sensus

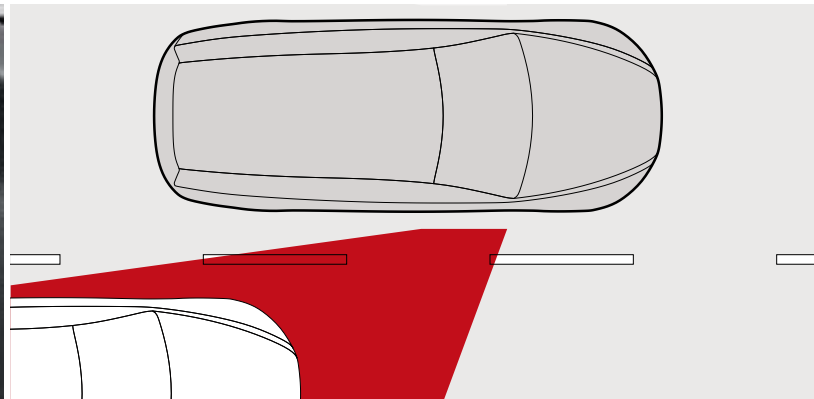

Blind Spot Information System (BLIS)

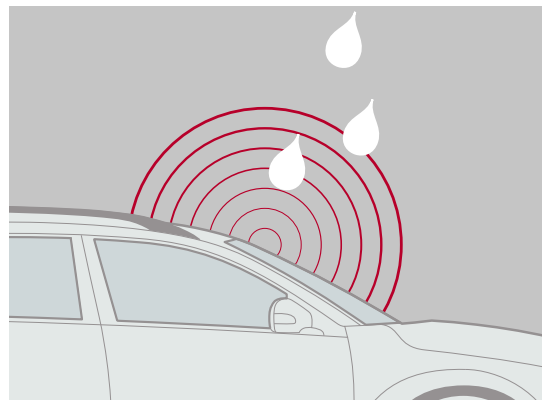

Rain sensor

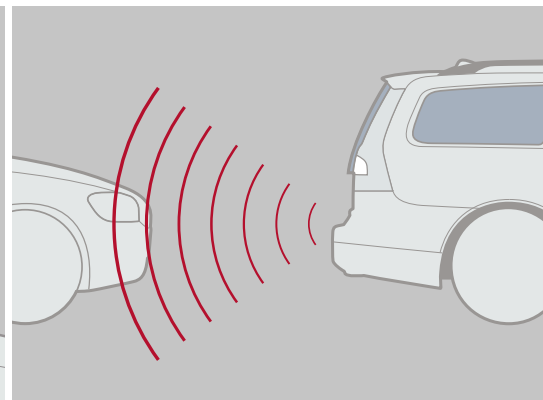

Front and Rear Park assist



Park Assist Camera



Integrated Bluetooth® handsfree system with streaming audio



Navigation System with RTT (Real Time Traffic) Voice Control and Map Care

TECH & SOUND

TECH & SOUND Driver's Support

Volvo Sensus

Volvo's new driver-control interface allows you to conveniently explore the hi-tech features of your car and personalise them to suit your needs. All information is displayed on a high resolution 7" colour screen. A push of the MY CAR button in the centre console gives you access to all system settings such as IDIS, City Safety, ACC, Collision Warning with Full Auto Brake and Pedestrian Detection, Driver Alert System, BLIS, light, door mirrors, climate, central locking and audio. The screen can also display the RTI navigation system, phone, and park assist camera. Everything is conveniently controlled using the ergonomic steering wheel controls – so you can keep your attention on the traffic and your hands on the steering wheel.

Blind Spot Information System (BLIS)*

BLIS uses rear-facing cameras installed in the door mirrors to keep a lookout on either side of the car. As a vehicle enters your blind spot, this function can alert you with a lamp built in to the front door post – left or right. Together with the door mirrors, this helps you assess the feasibility of a lane change. BLIS is activated once the car exceeds 10 km/h, and reacts to almost any type of vehicle from a motorcycle upwards, day or night.

* Optional

Rain sensor*

Once activated, the rain sensor can start the windscreen wipers as soon as it begins to rain or if water splashes onto the windscreen. It can also automatically adapt the intermittent windscreen-wiper function. Its sensitivity can be adjusted via a ring on the wiper stalk.

* Included in the optional Climate Package

Automatically dimmed inner rear-view mirror

This is a mirror that automatically adjusts itself to deflect the headlamp beams of the car behind you. When there's no light to dazzle you, it automatically readjusts to its normal setting.

Front and rear park assist*

Activated when you engage reverse gear, rear park assist helps you when reversing into tight spaces. The audio system is turned down and a pulsating sound from the rear loudspeakers becomes a continuous tone as you approach an obstacle. Front park assist performs a similar function at the front of the vehicle – alerting you via the front loudspeakers. The remaining distance is also shown on the audio display.

* Optional

Rear Park Assist Camera*

If the car is equipped with the optional navigation system the park assist camera, helps display what's going on behind your car when reversing. The system uses the navigation screen and a camera discretely located over the license plate. On-screen guiding lines provide extra assistance for smooth parking.

* Included in the Platinum trim level or as a retailer installed accessory

Electric Parking Brake

The Electric Parking Brake (EPB) makes moving off from steep gradients easier. Once depressed, the control lever automatically releases as the car pulls away.

TECH & SOUND Communication

Integrated Bluetooth® handsfree system with streaming audio

Bluetooth® technology enables a mobile phone to be connected to the infotainment system in your Volvo – wirelessly. Once configured for a mobile phone, the system automatically recognises your phone as you enter the car. You then operate your phone using the buttons in the steering wheel. As you climb in and out of the car, the system automatically allows you to switch freely from the phone to the handsfree system and back again

 The Bluetooth word mark and logos are owned by the Bluetooth SIG, Inc. and any use of such marks by Volvo Car Corporation is under license. Other trademarks and trade names are those of their respective owners.

Navigation System with RTT (Real Time Traffic) Voice Control and Map Care*

Volvo's navigation system is totally integrated with your car. It offers both voice guidance and graphic navigation all the way to your destination. The system is easily controlled from the steering wheel or a remote, and the screen is positioned so you can keep your attention on traffic. Two complimentary Map Care updates are included.

Maps do not cover all areas or all routes within an area. Also constant expansion and rebuilding of the road network mean that the digital map database is not always the latest road information. Always follow relevant regulations and road information.

* Included in the Platinum trim level or as a retailer installed accessory



Rear Seat entertainment (RSE) with dual DVD players

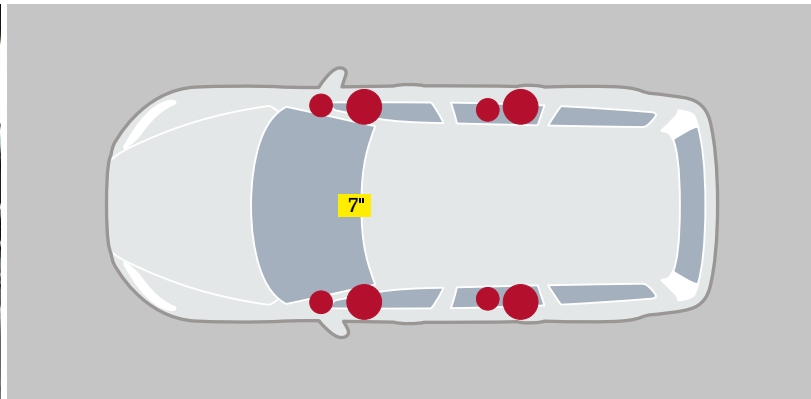

High Performance Sound system



SiriusXM Satellite Radio

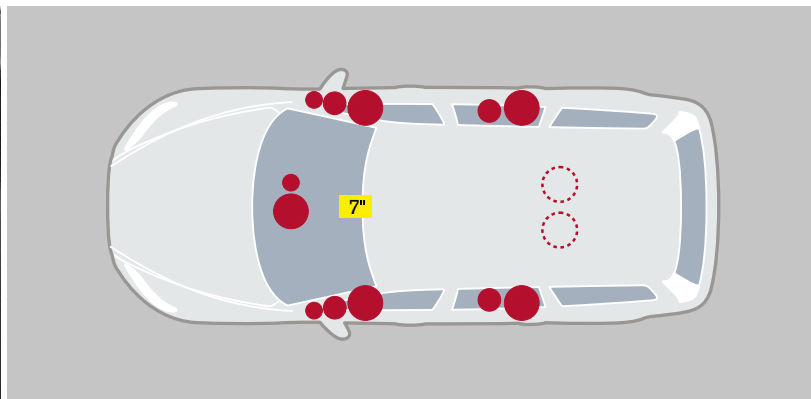

Premium Sound system



Three-split 40/20/40 rear seat



TECH & SOUND

TECH & SOUND Audio/Entertainment

MP3 compatibility

There are a number of ways to enjoy MP3 music files in your Volvo. If you'd like to connect your personal MP3 player to the audio system, there's a standard auxiliary audio input in the front centre armrest. Volume is conveniently controlled from the steering wheel, centre console or rear seat audio console. There's also a USB/iPod® port that allows you to fully integrate your iPod®, MP3 player or USB device with the audio system. The handsfree Bluetooth® system also adds streaming audio. Playlists, songs and artists are clearly displayed in the centre console. The audio system also features a MP3 and WMA compatible CD player.

iPod is a trademark of Apple Computer Inc.

Rear Seat Entertainment (RSE) with dual DVD players*

For more fun on long journeys, this easy-to-use system will entertain for hours. There are dual DVD players and dual 7-inch screens smartly integrated in the front head restraints. Each DVD player is conveniently operated by a rear seat passenger. The passengers can see the same movie or play the same game on both screens, or choose to view a film on one screen and play games on the other. Sound is provided via the car's audio system or wireless headphones.

* Retailer installed accessory

High Performance Sound system

This is a powerful and versatile 160 W audio system featuring advanced technology such as Bluetooth® with streaming audio and USB/iPod® connectivity. Each loudspeaker is fitted with a powerful magnet and a large coil. In combination with the amplifier, this system gives excellent transient reproduction and high power – simply superb sound.

Premium Sound system*

We designed this top-of-the line audio system to give you a superior listening and communication experience. This 650 W system features twelve high-fidelity loudspeakers that optimise the sound reproduction for the interior acoustics. Dolby® Pro Logic® II surround sound helps tailor a well-balanced audio experience for each occupant.

Dolby, Pro Logic, and the double-D symbol are registered trademarks of Dolby Laboratories.

* Included in the Platinum trim level

SiriusXM Satellite Radio*

Imagine driving along hearing the music you want, without having to flip through commercials, fumble with CDs or manage a playlist. Imagine hearing play-by-play action of your favourite team, no matter where you are. Or having channels and channels of comedy, talk, news, entertainment, family programming and more. Now imagine having all of this, coast-to-coast, wherever you drive. This is the world of SiriusXM. Each Volvo equipped with Satellite radio includes a 6-month trial subscription to the "Sirius Select" package.

* Optional



PACK & LOAD

PACK & LOAD Compartment

Three-split 40/20/40 rear seat

The rear seats feature 40/20/40 splits that provide two distinct seats with a solid armrest in the middle. This armrest can also be raised to provide a middle seat. Lowering the entire centre section provides ample space for loading long items. To provide multiple load configurations with a flat load floor, each seat can be folded separately or together.

Foldable front seat backrest

To help you carry long objects inside your Volvo, the front passenger seat backrest can be conveniently folded flat.



Power tailgate



Interior load carrying system



Load compartment mat, reversible and foldable



Load cover



Steel Cargo Barrier



Grocery bag holder



Electric cooler and heater box



Complete dirt protector

PACK & LOAD

PACK & LOAD Compartment

Cargo compartment

The wide tailgate opening facilitates loading and unloading. The cargo volume is 575 litres with the rear seatbacks up. This includes up to 46 litres cleverly hidden under the floor.

Power tailgate*

The tailgate can be opened automatically three ways: with the remote control, using the switch on the dashboard, or by pulling the handle. To help minimise risk of injury, only a switch in the tailgate can be used to trigger automatic closing. Also, an anti-pinch strip around the tailgate opening can detect obstructions to help avoid pinching fingers and things.

* Included in the Premier Plus trimlevel

Interior load carrying system

Volvo's innovative loading system features aluminium load rails in the floor with four sliding retractable hooks and attachment panels on both sides of the cargo compartment. Several accessories are available to insure nearly limitless versatility for anchoring and organising your gear.

Load divider*

This smart accessory consists of an elastic net and two aluminium rods that can be easily placed in different positions, for example, to separate dirty or wet objects from other cargo, or to protect fragile items.

* Retailer installed Accessory

Attachment panel with load hooks*

These hooks help increase cargo area safety and convenience by making it easy to anchor cargo with nets, straps or other accessories. They can be placed where you need them most for maximum flexibility.

* Retailer installed Accessory

Side net*

Keep luggage and loose items from shifting in the cargo compartment. With practical side net storage along either side of the load compartment.

* Retailer installed Accessory

Load securing net*

Attached to the floor-mounted load loops, this elastic net helps keep your gear securely in place in the cargo compartment. Colour-coordinated with the interior.

* Retailer installed Accessory

Load compartment mat, reversible and foldable*

Allows you to maintain the elegant appearance of the load compartment even if you occasionally transport dirty loads. With folded rear seat backrests, just fold out the mat to cover the entire load compartment floor. The mat is reversible and waterproof, with colour-keyed textile on one side and plastic on the other.

* Retailer installed Accessory

Load cover

Use this retractable load cover to conceal your gear in the load compartment. It's colour-coordinated with the interior.

Steel Cargo Barrier*

Made out of steel, this helps protect the occupants from unsecured cargo during hard braking. When it's not needed, just raise it parallel to the roof panel. Colour-coordinated with the interior.

* Retailer installed accessory

Grocery bag holder*

This integrated holder unfolds from the load compartment floor and keeps your shopping bags and other similar items in place.

* Included in the Premier Plus trimlevel

Electric cooler and heater box*

Beyond keeping your drinks cold in the load compartment, this can be used as a hot box to keep food warm. This connects to the power outlet in the load compartment.

* Retailer installed accessory

Complete dirt protector*

This durable vinyl liner covers the floor, the sides of the rear cargo area and the backs of the seats to protect against grime and water. It is simple to mount. The backrest section of the liner is split to allow the rear seat backrests to be folded down separately. The rear section can also be folded out to cover the bumper.

* Retailer installed accessory



Roof load carrying system



Square profile hitch

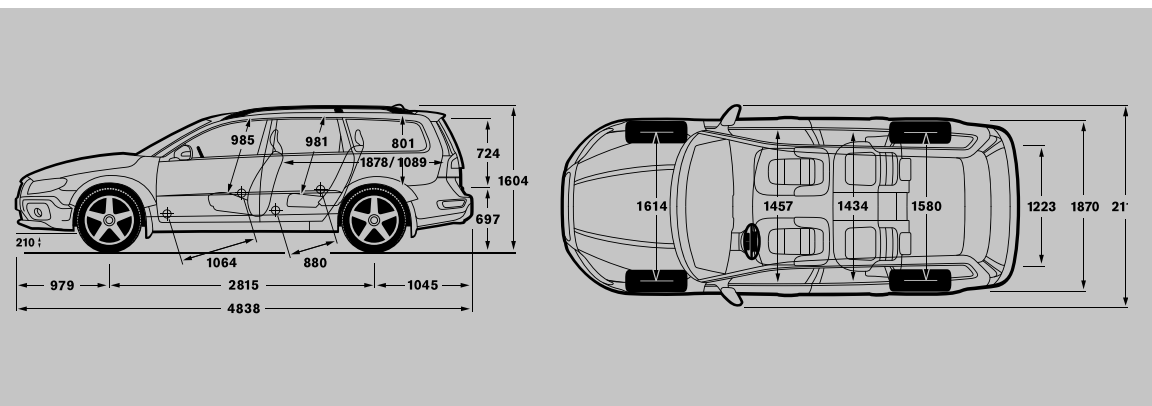

PACK & LOAD

PACK & LOAD Carrying/Towing

Roof load carrying system

To help you fully utilise the roof of your Volvo, we've developed a range of versatile load carrying accessories. This system is dimensioned to carry up to 100 kg. The factory-fitted attachment points in the car's roof make the load carriers easy to fit, and even quicker if your car has roof rails. Various load accessories – such as roof boxes and different holders for bikes, skis, surfboards and kayaks – can be attached to the load carriers to meet your needs. These accessories can be freely combined for flexibility and many are aerodynamically designed to help reduce fuel consumption and wind noise. And most of them can be locked with the same key, using Volvo's One-Key System.

Square profile hitch

This robust detachable hitch is not only great for towing but can also be used to transport bikes, skis and other loads.

PERFORMANCE

PERFORMANCE Chassis/Steering

Driveline

Electronically controlled all-wheel drive (AWD) with Instant Traction™. A six-speed Geartronic automatic (allowing manual shifting). Power is continuously distributed to all four wheels by Volvo's pre-charged electronically controlled AWD with Instant Traction™. This minimises wheel spin for immediate acceleration and reassuring stability in all conditions. The six-speed Geartronic—a responsive automatic that's ideal for relaxed driving, tough conditions or towing. This also allows manual gear shifting so you can maintain a lower gear to bring up engine speed, or for the added assistance of engine braking. A special winter setting makes it easier to move off and maintain grip on slippery surfaces. The standard Hill Descent Control (HDC) offers a smooth and controlled hill descent on steep, rough roads using the brake system to control each wheel's speed.

* Optional 3.2

Chassis

Front suspension with spring struts (McPherson), anti-dive and anti-lift function. Active multi-link independent rear suspension. Anti-roll bars front and rear. DSTC (Dynamic Stability and Traction Control).

The Volvo XC70's all-road capability is based on generous ground clearance of 210 mm, a low centre of gravity and an advanced chassis. The rigid body promotes optimal suspension function and well-balanced handling with a high level of comfort. The front and rear suspensions also interact to provide smooth braking and steering. The DSTC stability system provides assistance if either of the drive wheels begins to lose traction or if a skid is imminent.

Steering

Power-assisted hydraulic rack and pinion steering. Tilt and telescopic steering wheel column. 2.8 turns lock to lock.

Behind the wheel, you can enjoy steering that's both responsive and reassuring at all speeds. The optional speed dependent power steering gives progressively less power assistance the faster you drive. Higher steering precision and enhanced road feedback are easily enjoyed benefits. At lower speeds, added power assistance makes the car even easier to maneuver, for instance when parking.

Brakes

Power-assisted anti-lock disc brakes (ABS), ventilated discs front. OHB (Optimised Hydraulic Brakes). HBA (Hydraulic Brake Assist). RAB (Ready Alert Brakes). FBS (Fading Brake Support). EBD (Electronic Brake Distribution) between the front and rear brakes. Diagonal-split braking system. Power Parking Brake (PPB).

Generously dimensioned anti-lock disc brakes and optimised hydraulics help to ensure a short stopping distance in all situations. Furthermore, they withstand tough use without fading. HBA helps you use your brakes to the full in an emergency situation, while RAB anticipates severe braking and prepares for it by moving the brake pads closer to the discs. FBS automatically compensates for the higher pedal forces required after long periods of heavy braking. EBD distributes the braking effect between the front and rear wheels to achieve optimal results according to load and driving conditions. The Electric Parking Brake makes moving off from steep gradients easier. Once depressed, the control lever automatically releases as the car pulls away. It can even be set to engage automatically as you extract the key.

PERFORMANCE Transmission

Six-cylinder, in-line, all-aluminium engines

Double overhead cam-shafts, 24 valves with Variable Valve Timing (VCT). These engines also feature Variable Intake System (VIS) and Cam Profile Shifting (CPS) on the intake camshaft. Electronic engine management system. Three-way catalytic converter with heated oxygen sensor.

These highly compact, in-line, six-cylinder engines meet high expectations in terms of performance, comfort and environmental care. Their smooth running and responsive character provides a relaxed yet responsive drive at all speeds. Advanced engine technology, such as a new intake system, helps increase torque over a wide speed range and ensures power at high rpm. On the T6, twin-scroll turbocharger technology provides extremely quick turbo boost. And depending on your driving style and the situation, the intake valve train automatically switches between economy and performance modes to optimise efficiency. The engines' compact design aids safety performance in a frontal collision. The latest generation of fast response emission control technology ensures that the engines comply with stringent environmental standards such as California's ULEV II.

PERFORMANCE Engines

XC70 T6 AWD (300 hp)

Engine type: 3.0-litre in-line six-cylinder turbo charged engine
 Max power output: 300 hp at 5600 rpm
 Max torque: 325 lb-ft. at 1500 – 4800 rpm
 Acceleration: 0–100 km/h 7.4 sec
 Top speed: 230 km/h
 Fuel consumption, litres/100 km, mixed cycle: 10.6
 Environmental classification: ULEV II
 Transmission: Six-speed Geartronic automatic
 Fuel tank: 70 litres

XC70 3.2 AWD (240 hp) / 230 hp PZEV

Engine type: 3.2-litre in-line six-cylinder engine
 Max power output: 240 hp at 6200 rpm
 Max torque: 236 lb-ft. at 3200 rpm
 Acceleration: 0–100 km/h 9.0 sec
 Top speed: 215 km/h
 Fuel consumption, litres/100 km, mixed cycle: 10.1
 Environmental classification: ULEV II
 Transmission: Six-speed Geartronic automatic
 Fuel tank: 70 litres

TAKING CARE OF YOUR OWNERSHIP NEEDS.

VOLVO LEASING AND FINANCING OFFERS.

Special offers are available to finance your new Volvo product through our preferred provider, Scotia Bank. Whether you are looking for the convenience of a lease or the pride of owning your Volvo vehicle, our nationwide network of retailers and authorized financial service providers are ready to assist you with all your financing needs. Please contact your local retailer for details .

On Call roadside assistance.

Whenever you need us, we're just a phone call away. Our nationwide network of retailers and authorized service providers are ready to assist. Whether you require roadside assistance or maps and routing information for your next trip, refer to your On Call Card and dial 1-800-263-0475 – anytime, day or night. Your complimentary four-year membership activates the moment you become a Volvo owner.

Volvo new car warranty.

Your new car warranty provides comprehensive coverage for four years or 80,000 kms, whichever occurs first. Additional warranties cover corrosion, seat belts, the supplemental restraint system, emission systems, genuine Volvo replacement parts and genuine Volvo accessories. Should you encounter any problem with your Volvo, simply contact the nearest retailer for assistance. Where your warranty ends, Volvo Increased Protection (VIP) plans begin. To purchase the additional protection of a VIP plan, contact your local retailer.

Volvo service for life.

Taking the concept of service to a new level.

- Two-year Parts Warranty. Including the labour when they're installed at an authorized Volvo retailer
- Complimentary Software Updates during a scheduled maintenance visit. New software required as part of repair or accessory installation is not included
- Complimentary Vehicle Diagnostics if your Volvo has a "check engine" lamp or other warning indicator illuminated. Up to an hour of computer diagnostics
- Special discounted On Call Roadside Assistance pricing. Visit your retailer for enrollment form

Volvo mobility program.

The goal of the Volvo Mobility Program is to assist persons with physical disabilities or hearing impairment. For those with exceptional transportation needs, this can be facilitated within the extraordinary comfort and safety of a specially adapted Volvo. For additional information on this program please see your local participating Volvo retailer or Volvo Car Canada Customer Relations at 1-800-663-8255.

VOLVO EUROPEAN DELIVERY.

Bring home an unforgettable overseas experience.

European Delivery, as part of Volvo Cars International Travelers Program, is a unique way to buy your custom-built Volvo as well as a unique way to see more of Europe. You can collect your new custom-built Volvo in Sweden, drive it while exploring your favourite destinations and then have it delivered in Canada after your return. And that is not all the program offers. You'll experience a variety of added incentives including two complimentary round-trip tickets and the opportunity of our special VIP Factory Delivery experience in Gothenburg, Sweden, the home of Volvo.

Purchase any new Volvo, take delivery in Sweden and enjoy all this and more

- Two complimentary round trip tickets to Gothenburg, Sweden
- One free hotel night for two in Gothenburg
- VIP delivery at the home of Volvo including our exciting Factory Tour
- The opportunity to explore Europe in your own Volvo
- 15 days International Insurance and Export registration
- Complimentary home shipment of your new Volvo to your authorized Volvo retailer in Canada
- 6.1% import duty included

The beauty of Scandinavia, French country roads, the thrills of the German autobahns, breathtaking alpine passes – it's all yours to discover. For an even more inspiring journey, travel in the comfort and safety of your own Volvo. And when you're done travelling, bring the pleasure of driving a Volvo back home. Can you think of a better way of travelling overseas and making your souvenir part of an unforgettable experience?

* Additional charges apply

VOLVO CARS EXPATRIATE SALES.

Are you moving abroad, living abroad, moving home or to a new country? If so, take advantage of the Volvo Cars Expat Sales program. Wherever you are stationed, our specialized and highly professional organization is there to guide you to the most convenient way to solve your car needs while abroad – and to buy your favourite Volvo model on special terms. Everybody's situation is different. If you are a Canadian Citizen temporarily living abroad we'll be happy to make your car purchase as simple as possible. Just get in touch (select Retailers) and our expert specialists will advise and assist you with all details or guide you to the correct source of information.

Your Personal Benefits Program

- Competitive expat pricing, savings and offers
- Extensive and customized delivery services
- Free shipment from Gothenburg, Sweden to an authorized Volvo retailer of your choice in Canada (from other locations a transfer charge will apply)
- Round-the-clock road assistance in Europe
- On Call service in Canada
- International warranties
- Swedish export registration and insurance. Subject to local regulations
- Option of VIP Factory Delivery experience
- Worldwide service network

For more information visit expat.volvocars.com

Canadian Fleet Sales

Volvo Cars of Canada is committed to providing your organization with a Premium Fleet Experience. Our core values of safety, quality and environmental care are the essence of our brand, and our dedication to these values allows us to build world-class automobiles that meet the needs of today's demanding fleet decision-makers and drivers. Our Premium Fleet Experience enhances customer treatment and satisfaction by providing consistent order-to-order delivery times with priority order placement at the factory, direct-order relationships with major fleet leasing companies, and premium courtesy delivery via Volvo Retailer that is convenient to the driver's location. Each Volvo offers a unique driving experience. We trust the Volvo you choose to best fit your fleet needs is better than anything you've driven before. For Sales people, Managers or Executives, Volvo range offers a large selection of models that perfectly matches your drivers' needs.

For more information, please contact us at:

Fleet Sales: (416) 493-3700 ext 5208

Fax: (416) 493-8754

Email: canfleet@volvocars.com

WELCOME TO THE CLUB. THE VOLVO XC70 MERCHANDISE COLLECTION.

This smart collection of lifestyle accessories captures the driving spirit of your new Volvo and reflects the best of modern Scandinavian design. The signature items below are a select few. Find more keepsakes, gifts and apparel at your local Volvo showroom and at www.volvocars.ca



Ceramic Mug



Sports Duffel



Metal Pen



Men's/Ladies' Watch



Compact Umbrella



SHOX Mini Speaker



Recycled Fashion Tote



Stainless Steel Water Bottle