



DESIGN THE VOLVO THAT'S REALLY YOU. EXPERIENCE IT INSIDE AND OUT. LEARN ABOUT THE DETAILS, TECHNICAL FEATURES AND ACCESSORIES. SEE FILMS ABOUT YOUR FAVOURITE VOLVO AND ITS INNOVATIONS. COMPARE DIFFERENT VOLVO MODELS AND ENGINE ALTERNATIVES. JOIN THE VOLVO COMMUNITY AND SHARE GREAT CAR STORIES FROM ALL OVER THE WORLD. FIND YOURSELF AT WWW.VOLVOCARS.CA



www.twitter.com/Volvo_Canada



www.facebook.com/VolvoCarsOfCanada

Specifications, features, and equipment shown in this catalogue are based upon the latest information available at the time of publication. Volvo Cars of Canada Corp. reserves the right to make changes at any time, without notice, to colours, specifications, accessories, materials, and models. For additional information, please contact your authorised Volvo retailer. © 2011 Volvo Cars of Canada Corp. Printed in USA on 100% recyclable paper. **MY12B Cnd**



Product group: Paper and board
www.fsc.org

VOLVO
Volvo Car Corporation

www.volvocars.ca

VOLVO XC90



**THERE'S MORE TO YOU THAN LIVING LARGE.
THERE'S GETTING WHERE YOU WANT TO GO.
THERE'S GETTING THERE IN STYLE AND COMFORT.
THERE'S POWER, AGILITY AND UNRESTRICTED
PLEASURE. AND THERE'S DESIRE. DESIRE TO ENJOY
THE BEST AND DESIRE TO SHARE THIS WITH THOSE
YOU LOVE, NO MATTER WHERE YOUR JOURNEY
TAKES YOU. THAT'S WHY THERE'S THE XC90.
THAT'S WHY YOU DRIVE ONE.**



THE SUBTLE APPLICATION OF PURE STRENGTH.

The XC90 wouldn't be the superb SUV it is without a little muscle. But the application of power without discrimination has never been our business, and here you'll find no exceptions. Among a wealth of outstanding performance enhancing technology you'll find features such as AWD with Instant Traction™ and six-speed Geartronic transmission with a winter setting.

Harmonising power with subtlety can be a bridge too far for many SUVs. But with one depression of the accelerator pedal on an XC90, you'll feel equal part of muscle and grace and instantly enjoy what is surely one of nature's most potent combinations.



**YOU CAN LEAVE IT,
BUT IT WILL NEVER LEAVE YOU.**

Why do the most profound experiences leave the deepest impression? Take the interior of the XC90. No matter what the world outside is doing, you, your friends or your family will be enveloped in an environment that is as calm and understated as it is luxurious. No surprise there really. This SUV was created for people who are dedicated to pleasure – and to sharing it. The only downside is that you'll occasionally have to leave your XC90. But don't worry. Experience this exceptional SUV once and it will never leave you.



**SOMETHING THIS GOOD WAS
ALWAYS MEANT TO BE SHARED.**

There are no second-class seats in the Volvo XC90. Painstaking craftsmanship and superior materials ensure that comfort and safety rule – from bumper to bumper. From its Interior Air Quality System* to a child-friendly booster cushion, nothing and no-one has been forgotten in the pursuit of pure satisfaction. And like many of the good things in life, the Volvo XC90 was made to be shared. Now it's over to you.

*Included in the optional Climate Package





64 EXPRESSIONS OF VERSATILITY.

Every one of the seven seats in the Volvo XC90 offers much more than superb comfort. They can also be configured in 64 different ways. Add the fact that every passenger seat can be folded flush and you have the perfect marriage of versatility and luxury. Loading is an easy job too – just open the liftgate section of the split tailgate for lighter objects or let both sections open wide for heavier loads.





UPGRADE YOUR COMFORT ZONE.

Our relentless quest to deliver pleasure expresses itself emphatically within the welcoming cocoon of the Volvo XC90. Electronic air control ensures that no matter what's happening on the other side of that toughened glass, you'll stay comfortable. Integrated Bluetooth® handsfree with streaming audio and optional dual screen Rear Seat Entertainment keeps things under control over your shoulder, should this be required.



WHEN WAS THE LAST TIME YOU FELT MUSIC?

There is one sure way to transform a journey into an event – add some good music. If you can do this through a system that leads the way in audio excellence, all the better.

Volvo's Premium Sound system* delivers a seriously moving aural experience. It features a digital class D amplifier, 12 high end loudspeakers and Dolby® Pro Logic® II surround sound and is fully compatible with your iPod® or MP3 player. We could say more but in this case, we'll let the music do the talking.

*Included in the Platinum trim level



IT TAKES EXTRAORDINARY CHARACTER TO SHOULDER BIG RESPONSIBILITY.

Engine power and an improved environment. To many, these terms sound like a contradiction. To us, they represent a call to action.

The challenge is to develop technology that doesn't compromise on performance while at the same time acknowledging our environmental responsibility. The result is the six-cylinder 3.2 with Variable Cam Timing and Cam Profile Shifting to optimise performance and fuel economy. This engine is a compact yet formidable power source. It provides up to 236 lb-ft of torque intelligently distributed to all four wheels with smooth, responsive acceleration for a relaxed yet exhilarating drive.

Carrying this power also presented challenges of its own. To meet these, design characteristics such as a low centre of gravity, precisely calculated weight distribution and high ground clearance were applied. As a result, you stay firmly and comfortably rooted to the road, no matter where it's taking you.



SOMETIMES A REDUCED PULSE RATE IS PREFERRED.

In the case of the Volvo XC90, relaxation is a state of mind not exclusive to driving or enjoying the ride. Leave this car and you'll be able to enjoy the same feeling. Tough door locks, and an electronic immobiliser help keep unwanted visitors at bay. Approach and Home Safe lighting provide welcome reassurance when entering and leaving the car in unlit areas.

Wherever it takes you, this SUV has the capacity to get your pulse racing. But when it comes to security, you'll be pleased to know it does exactly the opposite.



INNOVATED FOR YOUR ENJOYMENT, THE VOLVO SAFETY TECHNOLOGIES WILL PROTECT MORE THAN THE FUN OF DRIVING.

Across the world, Volvo equals safety. And that comes with good reason, because few carmakers can match our record of safety innovations and the commitment for safety that has guided us for more than 80 years. Of course, this makes us extremely proud. But we're not satisfied. Because we know what we want to achieve: zero accidents. This vision calls for innovative thinking and a brand new approach to the way we design cars. Good news is we've already come a long way. For starters, our cars are more fun and engaging to drive than ever (because a bored driver will never be a safe driver). Neither is the technology needed any figment of the imagination – some are already available. This means driving a Volvo today is like having a first peek at a very exciting automotive future – a future where passionate engineering and design do more to help you get the most out of life.

After all, there's more to life than a Volvo.



ALL-ROAD STABILITY.

Volvo's All-Wheel Drive (AWD) with Instant Traction™ enhances driving stability and traction in all weathers, all seasons and on all roads.

EYES IN THE BACK.

Park Assist alerts you if you're too close an obstacle behind your car when reversing.

KEEP THE BALANCE.

Roll Stability Control (RSC) senses an impending roll-over and helps stabilise the vehicle if needed.

STAY ON TRACK.

Volvo's anti-skid system Dynamic Stability and Traction Control (DSTC) improves handling and safety in a wide range of challenging situations.

EXHILARATING COMFORT.

Ergonomic design in seats and driver's environment makes you relaxed and helps maintain your concentration on driving.

AN EYE ON THE BLIND SPOT.

The optional Blind Spot Information System (BLIS) helps you detect vehicles entering your blind spot.

ON-ROAD ENLIGHTENMENT.

Dual Xenon headlights with active bending technology* expands your vision range when driving in the dark and provides considerably improved illumination around bends.

* Included in the Premier Plus trim level

DESIGNED TO CATCH THE LIGHT BRILLIANTLY, THIS CAR ALSO REFLECTS A PROMISE.

Thankfully, the automotive industry is moving away from fantasyland to the real world. Our journey towards a better environment started already in the early 70's. Then we were among the first carmakers to acknowledge the environmental downside of cars and to do something about it. Since then we are constantly innovating to reduce the environmental impact of the cars and how we make them.

In the near future we will introduce new technology such as plug-in hybrid vehicles that will further reduce CO₂ emissions and can be charged from a standard wall socket. And we're heavily engaged in the development of electrical vehicles – a technology that will dramatically reduce the environmental footprint of our cars and make them even more fun to drive.

Good for you, and for the world we share.

85% RECYCLABLE.

To help minimise its total environmental impact, every Volvo is designed to facilitate recovery and recycling at the end of its useful life.

ALLERGY-TESTED INTERIOR MATERIALS.

All our upholsteries and interior textiles are tested for certain allergy-inducing or harmful substances. And several interior metal details are tested with regard to contact allergies. Good for you, and for anyone who shares your ride.

CLEANER EXHAUST.

All Volvo engines comply with stringent international requirements. Fast responding after a cold start, Volvo's advanced emission control eliminates between 95 and 99% of carbon monoxide, hydrocarbons and nitrogen oxides from engine exhaust gases.

FRESH CABIN AIR.

A cabin filter removes dust, pollen and other particles from the incoming air. Continuously monitoring incoming air and shutting out carbon monoxide, ground-level ozone and nitrogen dioxide, Volvo's available Interior Air Quality System helps ensure that the air you breathe in the vehicle is cleaner than that outside when driving in heavy city traffic.

FUEL-SAVING DESIGN.

To reduce energy-loss from wind and roll resistance, we utilise advanced aerodynamic design, light-weight materials and low-friction technology. Together with state-of-the-art engine technology, this lowers your CO₂ emissions and helps you travel further on fuel.





WANT A DYNAMIC TOUCH?

If stylish and sporty looks get your pulse racing, this may be the Volvo XC90 for you: Leather Soft Beige upholstery in Offblack interior with wood inlays, leather-clad steering wheel, leather-clad gear knob. Exterior colour Saville Gray Metallic with colour matched Side Decor and Situla 18" Silver Bright aluminium wheels (Retailer accessory). Complete the dynamic touch with accessory Running Boards in aluminium.



OR MODERN LUXURY?

Some people prefer sophisticated, timeless elegance. If that sounds like you, your new Volvo XC90 with the Premier Plus trim can look like this: Leather Soft Beige upholstery in Sandstone Beige interior with Dark wood inlays, Dark wood steering wheel (optional) and Dark wood gear knob. Exterior colour Ember Black Metallic, Dual Xenon headlamps and optional Camulus 18" Silver Bright aluminium alloy wheels.

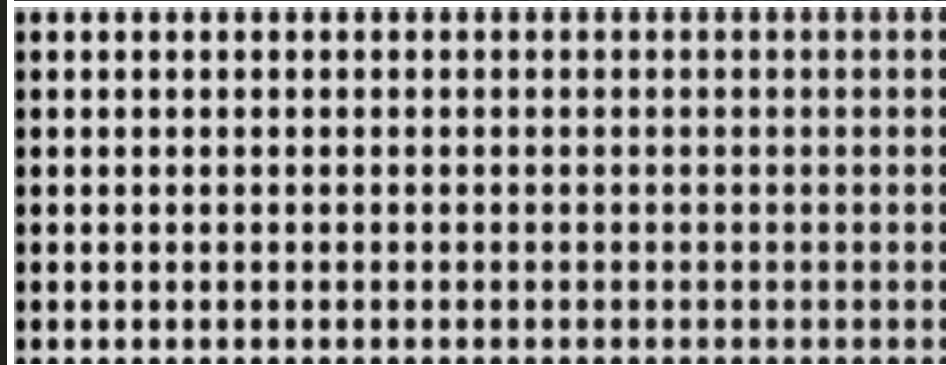

The R-DESIGN model of the multi-award-winning Volvo XC90 has it all: compelling performance, distinctive styling, and, of course, legendary Volvo safety. With its sports-tuned chassis, the Volvo XC90 R-DESIGN is not shy – especially not around corners. The exceptionally agile Volvo XC90 R-DESIGN secures its high-traction road-holding ability courtesy of a unique, sports-tuned chassis, sports-calibrated steering, and sophisticated stability control technologies. R-DESIGN is available on the XC90 3.2 (FWD and AWD).

The result is a vehicle that feels quicker and more responsive, yet remarkably composed and purposeful. This is active safety from Volvo that helps keep the thrill of driving (and much more) alive.

R-DESIGN tuned suspension and steering

The Volvo XC90 R-DESIGN has a specially tuned chassis that separates this vehicle from the crowd. The front suspension uses McPherson struts with anti-dive and anti-lift functionality. The multi-link independent rear suspension is attached to a steel sub-frame. The front and rear suspensions both have firmer shocks and stiffer stabiliser bars for added stability and quicker steering response.

Servotronic power steering

The R-DESIGN steering wheel with its aluminium inlay doesn't just look smart. Behind it, the Servotronic power steering uses sophisticated, speed-sensitive technology to regulate the amount of power assistance a driver needs. At highway speeds, steering is firmer and more immediate. When parking or in slow traffic, steering is light and effortless.

High performance wheels

With five large spokes, the distinctive Cratus 20" alloy wheels on the XC90 R-DESIGN couldn't be more serious about driving. Behind them lie large, ventilated disc brakes, firmer shocks for improved body control and stiffer stabiliser bars to help keep the car flat through hard turns.

Sports tailpipes

Unique chrome-finish tailpipes ensure that the XC90 R-DESIGN sticks out from the crowd. Indeed, this feature alone could be what other drivers notice first as they follow your lead.



CHOOSE YOUR VOLVO XC90.

As you define your own style and specify your needs, there's a range of equipment levels, factory installed options and accessories that can help reflect your taste or simplify your tasks. Find your personal Volvo at www.volvocars.ca

XC90 TRIM LEVEL:

PREMIER PLUS

- Leather Seating Surfaces
- Power Glass Moonroof
- 18" Camulus Alloy Wheels
- Active Dual Xenon Headlights (standard R-DESIGN)
- Digital Compass
- HomeLink® Integrated Garage Door Opener
- Grocery Bag Holder
- Classic Walnut Wood Gear Shift Knob (not available R-DESIGN)

PLATINUM

- Navigation System with Map Care
- Volvo Premium Sound System
- Leather Seating Surfaces
- Power Glass Moonroof
- 18" Camulus Alloy Wheels
- Rear Park Assist Camera
- Active Dual Xenon Headlights (standard R-DESIGN)
- Digital Compass
- HomeLink® Integrated Garage Door Opener
- Grocery Bag Holder
- Classic Walnut Wood Gear Shift Knob (not available R-DESIGN)

OPTIONAL PACKAGE:

CLIMATE PACKAGE

- Headlight washers
- Rain sensor
- Interior Air Quality System (IAQS)

STANDARD FEATURES

SAFETY	XC90 3.2	3.2 R-DESIGN
Collapsible steering column	●	●
Daytime running lights	●	●
Driver and front passenger supplemental restraint system –multi-threshold air bags	●	●
Dynamic Stability and Traction Control (DSTC)	●	●
Front cross-member for SUV-to-car impact compatibility	●	●
Inflatable Side Curtain (IC) (includes coverage for third-row occupants)	●	●
ISOFIX baby/child seat attachment (second row)	●	●
Pedestrian protection	●	●
Rear-door child safety locks	●	●
Roll-Over Protection System (ROPS)	●	●
Roll Stability Control (RSC)	●	●
Safe approach and home safe lighting	●	●
Seat belts: 3-point inertia-reel with automatic pre-tensioners for all seating positions; front belts include force limiters	●	●
Side impact air bags for driver and front passenger (SIPS bags II™)	●	●
Side Impact Protection System (SIPS)	●	●
Two-step remote entry, central power door locks	●	●
Ultra High Strength Steel reinforced passenger compartment	●	●
Volvo guard alarm with siren, battery back-up and immobiliser	●	●
Whiplash Protection Seating system (WHIPS)	●	●
INTERIOR		
Audio and cruise controls in steering wheel	●	●
Auto-dim rearview mirror	●	●
Bluetooth® with streaming audio	●	●
B-pillar ventilation for second-row passengers	●	●
Cabin pollen filter	●	●
Dual-zone electronic climate control (ECC)	●	●
Flat-folding 40/20/40 split second-row seat	●	●
Heated Front Seats	●	●
Illuminated vanity mirror in driver and front passenger sun visors	●	●
Leather-clad gearshift knob	●	●
Leather-clad steering wheel	●	N/A
Outside temperature gauge	●	●

	XC90 3.2	3.2 R-DESIGN
Power adjustable driver seat, 8-way with 3-position memory and lumbar support	●	●
Power adjustable passenger seat, 8-way with lumbar support	●	●
Power windows with driver and front passenger auto up/down with anti-trap feature	●	●
Reading lights (front, rear and third row)	●	●
Real wood inlays	●	N/A
Rear Park Assist	●	●
Textile floor mats	●	N/A
Third-row seating with A/C controls	●	●
Tinted rear windows	●	●
Trip computer	●	●
R-DESIGN Aluminium Inlays	N/A	●
R-DESIGN blue-faced instruments	N/A	●
R-DESIGN floor mats	N/A	●
R-DESIGN Sport leather steering wheel	N/A	●
R-DESIGN leather upholstery	N/A	●
12 beverage holders	●	●
12 V power outlet	●	●
EXTERIOR		
Aluminium Roof Rails	●	●
Front fog lights	●	●
Front stainless steel skid plate	●	●
Power adjustable heated exterior rearview mirrors	●	●
R-DESIGN grille	N/A	●
R-DESIGN satin mirror caps	N/A	●
R-DESIGN tailpipe	N/A	●
Rear wiper/washer	●	●
7x17" alloy wheel Neptune	●	N/A
8x20" alloy wheel Cratus	N/A	●

 The Bluetooth word mark and logos are owned by the Bluetooth SIG, Inc. and any use of such marks by Volvo Car Corporation is under license. Other trademarks and trade names are those of their respective owners.

INDIVIDUAL OPTIONS

	XC90 3.2	3.2 R-DESIGN
Blind Spot Information System (BLIS)	○	○
Metallic paint	○	○
Volvo Dual Screen Rear Seat Entertainment System	○	○
Wood Steering Wheel	○	N/A

● = Standard ○ = Option N/A = Not available





COLOUR YOUR VOLVO.

When it comes to the appearance of your Volvo, the choices of exterior colour and wheels are probably your most important design decisions. For more exterior styling options and to build your new Volvo online, please visit www.volvocars.ca



614 Ice White
(also available for R-DESIGN)



477 Electric Silver Metallic
(also available for R-DESIGN)



612 Passion Red
(only available for R-DESIGN)



498 Caspian Blue Metallic

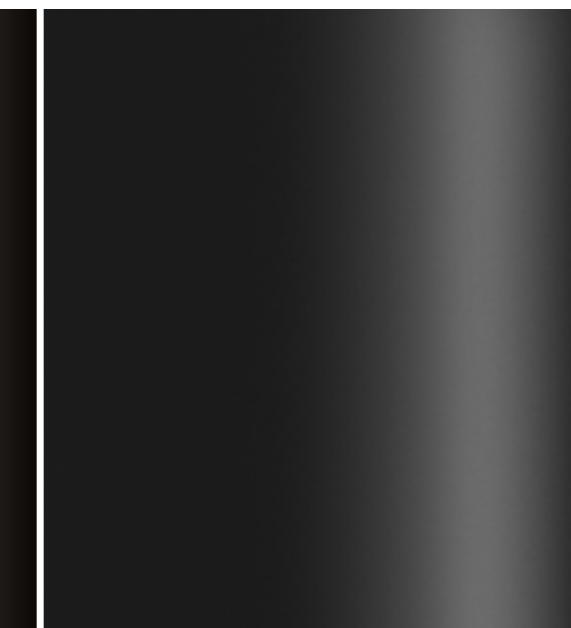

472 Oyster Grey Metallic

492 Savile Grey Metallic

452 Black Sapphire Metallic
(only available for R-DESIGN)

487 Ember Black Metallic

019 Black Stone

Please note: It's not possible to reproduce exact original shades in printed matter. Please ask your dealer to show you samples.

EXTERIOR DESIGN

It's muscular without being aggressive. Purposeful lines hint at a truly versatile character, while its refined dynamic looks reveal a more sophisticated side. Rounded shapes interact with distinctively sculpted sections, creating a confident Scandinavian style.

Add to this a stance that leaves no doubt as to the intentions of this Volvo SUV. And to further emphasise the adventurous spirit of the Volvo XC90, there are a number of specially designed styling options.

Aluminium running boards and foot steps

Provide a more striking impression while matching the front and rear skid plates. What's more, they protect the door sills on uneven surfaces and make it easier to get in and out – and they're useful when loading the roof. Designed for a load of 300 kg. For extra convenience, foot steps can be added to the running board

Side décor

Running along the bottom of the doors and wheel arches, the side décor gives the Volvo XC90 an even more exclusive appearance. It's painted in the same colour as the vehicle and features an integrated Metallic lower moulding.

Aluminium crossbars

An aerodynamic design element that complements the roof rails and the design of your Volvo. These aluminium crossbars also allow you to exploit the roof's load-carrying capacity to the full.



EXTERIOR DESIGN Aluminium wheels



Cratus 8x20"
Silver Bright 255/45/20 tires
(Standard R-DESIGN)



Camulus 7x18"
Silver Bright 235/60/18 tires
(Included in the Premier Plus trim level)



Neptune 7x17"
Silver Bright 235/65/17 All Season Tires
(Standard)

ACCESSORY Aluminium wheels



Thalassa 8x20"
Diamond Cut/Dark Grey matt or Light Grey



Oceanus 8x19"
Silver Bright

INTERIOR DESIGN



Leather-clad steering wheel, Offblack



Leather-clad steering wheel, Sandstone Beige



R-DESIGN Leather-clad sports steering wheel, Offblack with aluminium inlay



Wooden steering wheel, Offblack Beige



Wooden steering wheel, Sandstone Beige



Gear knob with Dark wood trim Geartronic (Premier Plus trim level)



Leather-clad gear knob Geartronic



Dark wood trim in tunnel console and glove box

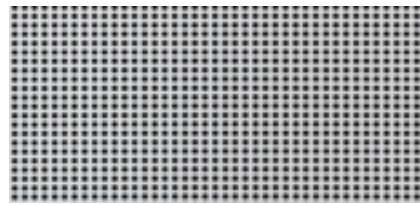

R-DESIGN aluminium decor



R-DESIGN leather Offblack (CBSB)



Offblack interior, Leather (C900) (Premier Plus Trim Level)



Offblack interior, Textile (C000) (Standard)



R-DESIGN leather Calcite (CBQJ)



Sandstone Beige interior, Leather (C910) (Premier Plus Trim Level)

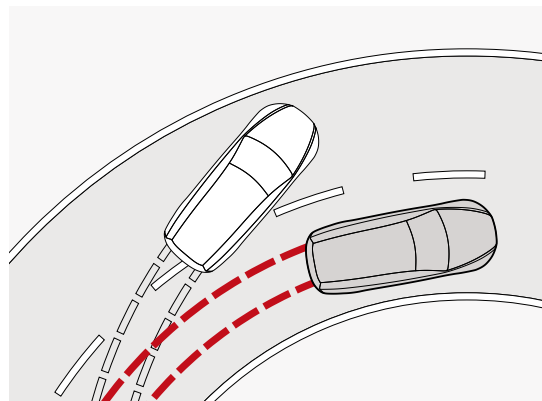

Dynamic Stability and Traction Control (DSTC)

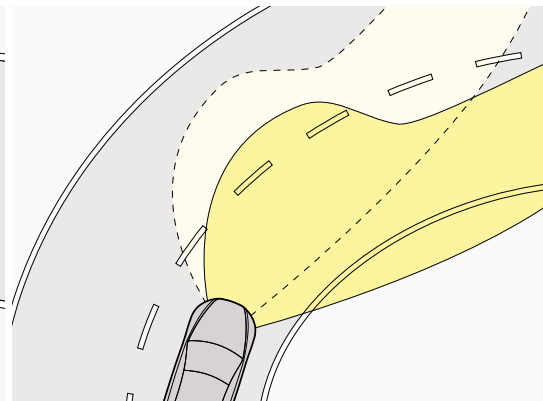

Dual Xenon Headlights with Active Bending Lights (ABL)

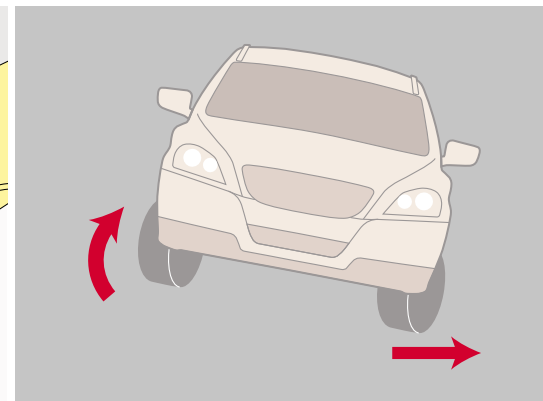

Roll Stability Control (RSC)



Volvo's interactive safety technologies

SAFETY

SAFETY Preventive

Dynamic Stability and Traction Control (DSTC)

By helping prevent fishtails, spinouts, and rollovers, stability control technology like DSTC has been described as one of the most vital safety advances of the past decade. At the core of DSTC, a gyroscope senses the car's direction and compares this with steering wheel movements as well as the actual rotation of the car's wheels. DSTC is able to detect a potential skid and help counteract this by reducing the engine's power output, or braking on one or more wheels.

Dual Xenon Headlights with Active Bending Lights (ABL)*

In addition to improving illumination by about using Dual Xenon light technology, the Active Bending Lights give a boost to your vision round bends at night. Controlled by microprocessors, the motorised lamps turn up to 15 degrees in either direction when driving – reliably lighting up your chosen path. A twilight sensor disengages the adaptive function during daylight to extend its life span.

* Standard R-DESIGN, included in the Premier Plus and Platinum trim level

Roll Stability Control (RSC)

In the event of an emergency manoeuvre, Volvo's Roll Stability Control (RSC) can step in to help prevent the vehicle from rolling over. It features a gyroscopic sensor that registers the vehicle's lean angle and rollover risk. If required, RSC will cut engine power or brake one or more of the wheels just enough to reduce the centrifugal force and help regain balance.

SAFETY Protective

Volvo's interactive safety technologies

In a Volvo, safety is about interaction. Because it's not the number of safety features that determines how safe a car is, it's how well they seamlessly interact to help protect the occupants in the event of a collision.

IN A REAR IMPACT the rear deformation zones will help absorb crash energy. Even behind the third row there's a good deal of space to help provide effective protection. The fuel tank is designed to remain well protected in front of the rear axle.

The head restraints help protect the neck and spine, and Volvo's unique Whiplash Protection System (WHIPS) cradles the front seat occupants in a controlled manner to help prevent whiplash injuries.

IN A SIDE IMPACT Volvo's unique Side Impact Protection System (SIPS) helps distribute the crash forces across the car's body, away from the occupants. The side airbags in the front seats help protect the chest and hip, while the Inflatable Curtain (IC) adds head protection for all outboard occupants, including the ones in the third row.

IN A ROLL-OVER a gyroscope activates Volvo's Roll-Over Protection System (ROPS). The safety belt pre-tensioners

deploy to help keep occupants more securely restrained, and the Inflatable Curtain (IC) helps provide head protection. Additionally, the safety cage is reinforced to help keep the passenger compartment intact.

IN A FRONTAL COLLISION the generous deformation zones will yield to help absorb crash energy. The compact power train is designed to help optimise deformation. Inside the vehicle, safety belts interact with the collapsible steering column and dual-stage airbags to help keep the occupants out of harm's way. A lower cross member helps protect occupants in an oncoming car with lower positioned bumpers. The front and bonnet are also designed to help reduce the risk of injury to unprotected road-users.

Frontal structure

The generous front deformation zones are designed to yield in a controlled way to help absorb crash energy before it reaches the cabin. The transversely mounted and very compact engine enables optimal use of the deformation zones to help protect occupants. Longitudinal steel struts help disperse crash energy away from the front to the rear of the vehicle, further helping to reduce the strain on the occupants.



Whiplash Protection System (WHIPS)

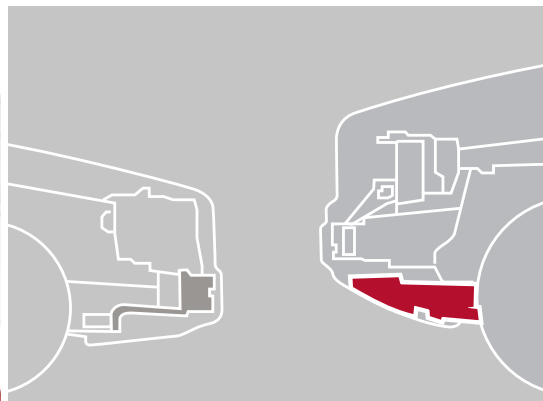

Lower cross member



Roll-Over Protection System (ROPS)



HomeLink®



Power retractable door mirrors with ground lighting



Power front seats



Fore-aft adjustable second row



Seven individual seats

SAFETY

SAFETY Protective

Whiplash Protection System (WHIPS)

Integrated in the front seats, Volvo's WHIPS cradles the occupant to help reduce the risk of whiplash injury (one of the most common types of traffic injury and often the result of a low-speed rear impact collision). The function is activated by a collision of sufficient force from behind. Independent research has shown that WHIPS is one of the most effective systems in the world and can reduce the risk of long-term invalidity by 50%.

Restraint technologies

In a collision, Volvo's restraint technologies interact to help reduce the impact. The **safety belts with pre-tensioners** activate within a few thousandths of a second in the event of a collision or roll-over and tighten the belt to help keep the occupants securely restrained. The front seat safety belts then release a little so that the driver and passenger are cushioned by the airbags in a controlled manner. Helping to optimise protection, the **dual-stage airbags** adapt the level of inflation depending on the force of the collision. The driver's airbag also interacts with the deformation of the collapsible steering column. **Side airbags** in the front seats help reduce the risk of serious injuries in a side collision. In a collision or roll-over, the **Inflatable Curtain (IC)** helps protect the heads of both front and rear outboard occupants. It also stays inflated for some seconds to provide prolonged protection for subsequent impacts.

Lower cross member

To help protect the occupants in an oncoming car with lower positioned bumpers, there's a low cross member integrated in the front structure. In an impact, this cross member is designed to help activate the other car's own crumple zones and other safety systems to help reduce the risk of injury.

Roll-Over Protection System (ROPS)

A robust roof structure together with Volvo's unique Roll-Over Protection System (ROPS) help protect the occupants in a rollover situation. ROPS is activated by a gyroscope that monitors the vehicle's leaning angle. The safety belt pre-tensioners are activated at every seat to help keep occupants more securely restrained. At the same time, the inflatable

curtain (IC) deploys and remains inflated for several seconds to help provide extended protection. To help keep the passenger compartment intact despite severe external forces, door pillars and strategic parts of the safety cage is reinforced in ultra high-strength steel.

Pedestrian protection

To help reduce the risk of serious injuries on unprotected road-users, the front of the vehicle is gently rounded, the headlamps are integrated flush with the body, and the bonnet is energy-absorbing to act as a crumple zone.

Side Impact Protection System (SIPS)

SIPS is a Volvo unique safety system that has been developed to help protect where occupants are most exposed to the crash forces. The steel framework of the vehicle – including the front seats – is designed and reinforced to help displace the impact of a side-collision away from the occupants to other parts of the car body and help prevent intrusion into the cabin. The side structure is extremely strong to help withstand a severe side impact. The Inflatable Curtain (IC) for all the outboard occupants including the ones in the third row and the front seat side airbags interact to help provide further protection.

SAFETY Security

HomeLink®**

With buttons integrated in the sun visor, HomeLink® allows you to operate remote controlled home appliances – such as garage door, home alarm and exterior lighting – without leaving the car.

HomeLink is a registered trademark of Johnson Controls Technology Company.

* Included in the Premier Plus and Platinum trim level

Power retractable door mirrors with ground lighting*

At the touch of a button, these door mirrors can be folded flat against the car where they are less likely to get damaged after you've parked. The integrated ground lighting is activated with the remote control. Beyond enhancing security to and from your car at night, this is also convenient when getting in and out.

* Included with the optional Blind Spot Information System (BLIS)

Approach and Home Safe Lighting

Activated with the remote control, Approach Lighting provides a warm reception on a dark night. This consists of interior and side lights – ground lighting too, if you choose it. Home Safe Lighting is activated with the headlight stalk as you leave the car and it provides a similar courtesy when exiting your car. This feature includes a dipped beam from the headlight to accompany you to your door.

COMFORT

COMFORT Seats

Power front seats

Find your perfect driving position with push-button ease. The driver's seat also incorporates a memory function that stores three separate seat and door mirror settings connected to a specific remote control – a feature that's appreciated when the car has several drivers.

Fore-aft adjustable second row

Each seat in the second row can be moved forwards and backwards to offer you maximum comfort and versatility. While the outer seats can slide forward a full 100 mm, the middle seat features an integrated booster cushion and can slide forward nearly 300 mm so you can move a child closer to the adults in the front. And to provide added legroom for the passenger in the middle seat, simply remove the centre console's rear section.

Seven individual seats

All occupants will appreciate the comfort of a separate, ergonomically designed seat. Cinema-style seating helps provide an excellent view, wherever you're seated. The easily adjustable front and second row seats make it easy to find the perfect seating position and maximum comfort. The middle seat also features an integrated booster cushion. In the third row of seats two passengers of up to 160 cm ride comfortably. Each rear seat is easy to fold individually into the load area floor so you can transport both passengers and cargo without compromising on either comfort or safety.



Power glass moonroof



Third row AC



Electric cooler and heater box

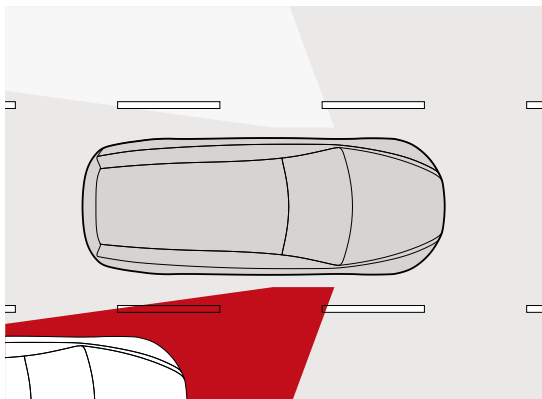

Blind Spot Information System (BLIS)

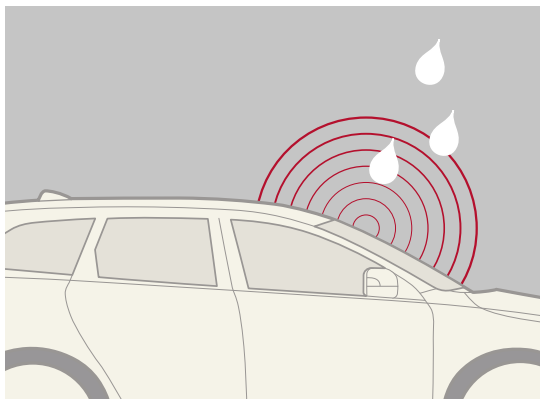

Rain sensor

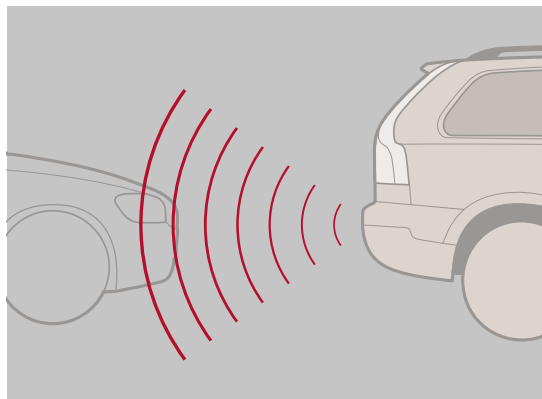

Front and Rear Park assist



Park Assist Camera



Portable navigation System



Volvo Navigation System (VNS) with RTT (Real Time Traffic)

COMFORT

COMFORT Climate

Electronic Climate Control (ECC)

ECC ensures you and your passengers always enjoy a pleasant in-car climate. It maintains the set temperature inside the car however much the temperature outside changes, or the sun shines in. The driver and front-seat passenger can set the temperature individually for each side.

Interior Air Quality System (IAQS)*

Volvo's IAQS continuously monitors incoming air and will, if necessary, temporarily close external air vents to shut out carbon monoxide, ground-level ozone and nitrogen dioxide. Meanwhile, an active carbon filter protects the occupants from other harmful gases and unpleasant odours. This helps to ensure that the air you breathe in the car is cleaner than that outside when driving in heavy city traffic and tunnels.

* Included in the optional Climate Package

Power glass moonroof*

This makes the interior feel extra light and airy. It opens and closes at the touch of a button. If the sun is too strong, just close the built-in sun screen.

* Included in the Premier Plus trim level

Third row AC

Supplementing Electronic Climate Control, this manual air-conditioning system boosts comfort in the third row. Passengers can conveniently adjust fan speed themselves and regulate air flow via separate vents.

COMFORT Storage

Electric cooler and heater box*

Beyond keeping your drinks cold in the load compartment, this can be used as a hot box to keep food warm. This connects to the power outlet in the load compartment.

* Retailer installed accessory

Cup holders, rear

Retractable cup holders are easily accessed in the rear of the tunnel console, and bottles can be conveniently stored in the door panels.

TECH & SOUND

TECH & SOUND Driver's Support

Blind Spot Information System (BLIS)*

BLIS uses rear-facing cameras installed in the door mirrors to keep a lookout on either side of the car. As a vehicle enters your blind spot, this function can alert you with a lamp built in to the front door post – left or right. Together with the door mirrors, this helps you assess the feasibility of a lane change. BLIS is activated once the car exceeds 10 km/h, and reacts to almost any type of vehicle from a motorcycle upwards, day or night.

* Optional

Rain sensor*

Once activated, the rain sensor can start the windscreen wipers as soon as it begins to rain or if water splashes onto the windscreen. For your convenience, it can also automatically adapt the intermittent windscreen-wiper function. Its sensitivity can be adjusted via a ring on the wiper stalk.

* Included in the optional Climate Package

Front and Rear Park assist*

Activated when you engage reverse gear, rear park assist helps you when reversing into tight spaces. The audio system is turned down and a pulsating sound from the rear loudspeakers becomes a continuous tone as you approach an obstacle. Front park assist* performs a similar function at the front of the vehicle – alerting you via the front loudspeakers. The remaining distance is also shown on the audio display.

* Rear Park Assist is standard. Front Park Assist is a Retailer installed accessory

Rear Park Assist Camera*

If the car is equipped with Volvo Navigation and park assist, the camera helps display what's going on behind your car when backing up. The system uses the navigation screen and a camera discretely located over the license plate. On-screen guiding lines provide extra assistance for smooth parking.

* Included in the Platinum trim level

TECH & SOUND Communication

Portable navigation System*

Navigate with style and ease. This new ultra-thin versatile Garmin nüvi 3790 navigation unit integrates smoothly with the design of your Volvo. Just fit it into the docking unit at the windscreen pillar. Find the shortest, fastest or most fuel-saving route – voice recognition control and convenient multi-touch glass screen technology facilitates operation. Just keep your hands on the steering wheel and the system will act upon your spoken commands. Major buildings and points of interest are displayed in 3D to enhance your overview, and in junctions you're conveniently guided to the right lane at the right time. Using Traffic Message Channel (TMC) radio data technology, the navigation system will let you know if there are traffic disturbances on route and recommend an alternative. The system also features Bluetooth® handsfree phone technology and FM transmitter. And the navigation unit is easy to use outside the car – it even remembers where you parked your car.

nüvi is a trademark of Garmin Ltd.

* Retailer installed accessory

Volvo Navigation System (VNS) with RTT (Real Time Traffic)*

Volvo's GPS-based VNS navigation system is totally integrated with your car. It offers both voice guidance and graphic navigation all the way to your destination. Via TMC (Traffic Message Channel) radio data broadcasts VNS also lets you know if there's weather-related trouble on route and recommends an alternative. The VNS system is easily controlled from the steering wheel or a remote, and the screen is positioned so you can keep your attention on traffic.

* Maps do not cover all areas or all routes within an area. Also constant expansion and rebuilding of the road network mean that the digital map database is not always the latest road information. Always follow relevant regulations and road information.

* Included in the Platinum trim level



Rear Seat Entertainment (RSE) with dual DVD players

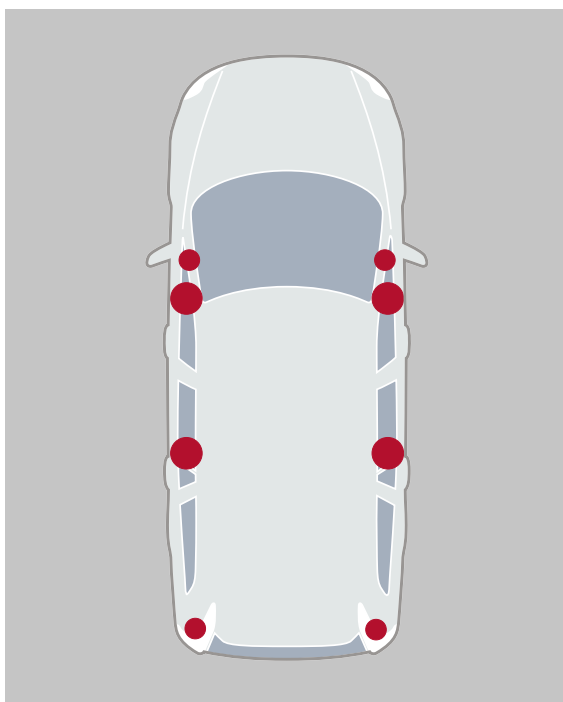

High Performance sound system

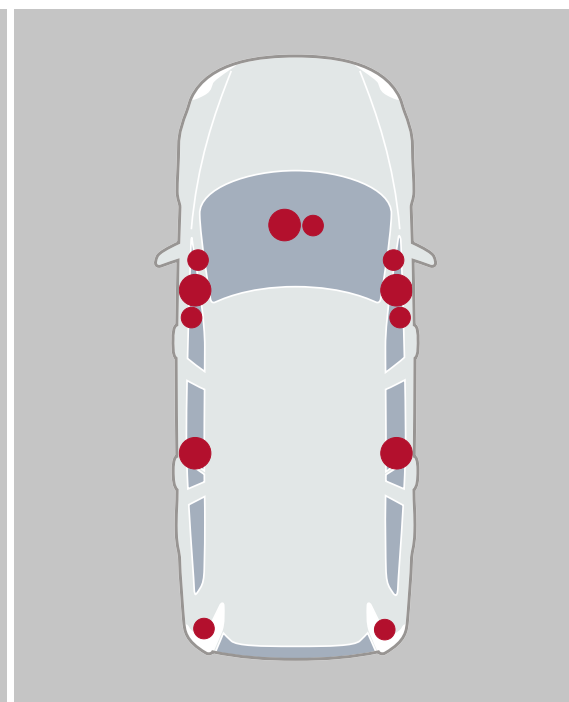

Premium Sound System

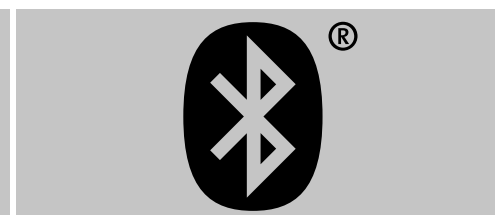

Bluetooth® handsfree system with streaming audio



MP3 compatibility

TECH & SOUND

TECH & SOUND Audio/Entertainment

Rear Seat Entertainment (RSE) with dual DVD players*

For more fun on long journeys, this easy-to-use system will entertain for hours. There are dual DVD players and dual 7-inch screens smartly integrated in the front head restraints. Each DVD player is conveniently operated by a rear seat passenger, and the screens can be adjusted in different angles to optimise image quality. The AUX sockets are within easy reach and make it possible to view a film on one screen and play games on the other. Sound is provided via the car's audio system or wireless headphones.

* Retailer installed accessory

High Performance

A powerfully versatile system. Each loudspeaker is fitted with a powerful magnet and a large coil. Coupled to the High Performance amplifier, this system provides superb transient reproduction, high power durability and low distortion for a superb listening experience. High Performance includes:

- MP3 and WMA compatible CD player
- 160 W High Performance amplifier
- 8 High Performance speakers
- AUX and USB input

Premium Sound System*

The Sound System is in a class of its own. The digital class D amplifier generates 650 watts of music. Dolby® Pro Logic® II surround sound recreates a sound that's equally authentic at each seating position. There are 12 high-end loudspeakers for the Volvo XC90 and a true concert hall experience. The Premium Sound System includes:

- MP3 and WMA compatible CD player
- 5x130 W digital class D amplifier
- 12 Premium Sound speakers
- Dolby® Pro Logic® II surround sound with centre speaker and digital sound processor
- AUX and USB input

Dolby, Pro Logic, and the double-D symbol are registered trademarks of Dolby Laboratories.

* Included in the Platinum trim level

Bluetooth® handsfree system with streaming audio

This handsfree system automatically recognises your Bluetooth® compatible mobile phone as you enter the car and seamlessly takes over, allowing you to switch freely from the mobile phone to the handsfree system. Just touch the blue button and the Bluetooth® handsfree system will listen to your command and make calls for you. The system's sound quality with noise reduction optimises for all parties in conference.

The Bluetooth word mark and logos are owned by the Bluetooth SIG, Inc. and any use of such marks by Volvo Car Corporation is under license. Other trademarks and trade names are those of their respective owners.

MP3 compatibility

There are a number of ways to enjoy MP3 music files in your Volvo XC90. If you'd like to connect your personal MP3 player to the audio system, there's a standard auxiliary audio input between the front seats. Volume is conveniently controlled from the steering wheel, centre console and rear headphone connectors. Choosing the High Performance or Premium Sound audio system, there's also a USB port that allows you to fully integrate your iPod®, MP3 player or USB device with the audio system.



Foldable front seat backrest



Cargo cover



Cargo Net



Complete dirt protector



Cargo compartment mats



Steel cargo barrier and cargo compartment divider

PACK & LOAD

PACK & LOAD Compartment

Foldable front seat backrest

To help you carry long objects inside your Volvo, the front passenger seat backrest can be conveniently folded flat.

Cargo compartment

The cargo volume is 615 litres with the second row seatbacks up, while the full loading capacity is 1837 litres. Each passenger seat can be folded individually to give you maximum flexibility for combining passengers and cargo. The head restraints are easily folded out of the way. And by folding flat the middle seat, you can transport long loads while still carrying passengers in unimpaired comfort and safety.

Dual-split tailgate

A convenient loading height and a dual-split tailgate with the lower section at the same height as the load compartment floor make the Volvo XC90 easy to load and unload. The lower section of the tailgate also serves as a stable platform for accessing cargo on the roof – or a convenient bench that can be supplemented with a seat cushion and a picnic table.

Cargo cover*

A retractable load cover to conceal your gear in the load compartment. Colour-coordinated with the interior. In the seven-seater version, it can only be used when the third row seats are folded down.

* Retailer installed accessory

Cargo Net*

A practical fabric net that helps prevent cargo from sliding around in the cargo area. Made of a durable elastic material, it makes it easy to load items under the net.

* Retailer installed accessory

Complete dirt protector*

This durable vinyl liner covers the floor, the sides of the rear cargo area and the backs of the seats on the second row to protect against grime and water. It is simple to mount. The backrest section of the liner is split to allow the backrests to be folded down separately. The rear section can also be folded out over the lower tailgate section.

* Retailer installed accessory

Cargo compartment mats*

The load compartment mats – in textile or moulded plastic – are tailor-made to fit perfectly in your XC90. The textile mat is reversible and waterproof, with colour-keyed textile on one side and rubber on the other. This allows you to maintain the attractive appearance of the cargo compartment even if you occasionally transport dirty loads.

* Retailer installed accessory

Cargo compartment divider*

Used together with the steel cargo barrier, this divides the cargo compartment into two sections – convenient if you want to carry your dog and luggage, or to separate dirty or fragile cargo from other cargo.

* Retailer installed accessory

Steel cargo barrier*

Fitted behind the second row of seats to help protect occupants from unsecured cargo when braking hard. Colourmatched with the interior.

* Retailer installed accessory



Roof load carrying system



Square profile hitch

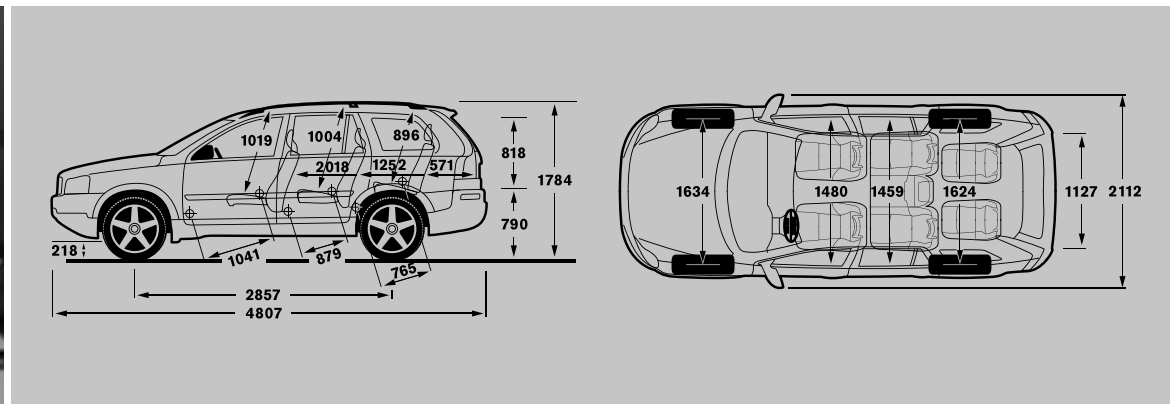

PACK & LOAD

PACK & LOAD Carrying/Towing

Roof cargo carrying system*

To help you fully utilise the roof of your Volvo, we've developed a range of versatile cargo carrying accessories. This system is dimensioned to carry up to 100 kg. The factory-fitted attachment points in the car's roof make the cargo carriers easy to fit, and even quicker if your car has roof rails. Various cargo accessories – such as roof boxes and different holders for bikes, skis, surfboards and kayaks – can be attached to the cargo carriers to meet your needs. These accessories can be almost freely combined for flexibility and many are aerodynamically designed to help reduce fuel consumption and wind noise. And most of them can be locked with the same key, using Volvo's One-Key System.

* Retailer installed accessory

Square profile hitch*

This robust detachable hitch is not only great for towing but can also be used to transport bikes and skis.

* Retailer installed accessory

PERFORMANCE

PERFORMANCE Chassis/Steering

Driveline

Electronically controlled all-wheel with Instant Traction™ and a Six-speed Geartronic automatic transmission is standard.

Power is continuously distributed to all four wheels by Volvo's pre-charged electronically controlled AWD with Instant Traction™. This minimises wheel spin for immediate acceleration and reassuring stability in all conditions. The six-speed Geartronic – a responsive automatic that's ideal for relaxed driving, tough conditions or towing. This also allows manual gear shifting so you can maintain a lower gear to rev the engine or for the added assistance of engine braking. A special winter setting makes it easier to move off and maintain grip on slippery surfaces.

Chassis

Front suspension with spring struts (McPherson), anti-dive and anti-lift function. Multi-link independent rear suspension attached to a steel sub-frame. Stabiliser bars front and rear. DSTC (Dynamic Stability and Traction Control) and RSC (Roll Stability Control).

The Volvo XC90's all-road capability is based on generous ground clearance (218 mm), a comparatively low centre of gravity and an advanced chassis. The rigid body enables optimal suspension performance, balanced handling and a high level of comfort. The front and rear suspensions interact to provide stable braking and smooth steering. In a curve, the rear wheels have a slight steering facility for added stability and steering response. The DSTC system cuts in if either of the drive wheels begins to lose traction or if a skid is imminent. RSC (Roll Stability Control) can step in to help prevent the vehicle from tipping over in an emergency situation.

Steering

Power-assisted rack and pinion steering. Tilt and telescopic steering wheel column. 2.8 turns lock to lock. Turning circle 12.2 metres.

Behind the wheel, you can enjoy steering that's both responsive and reassuring at all speeds. The optional-speed dependent power steering provides progressively less power assistance the faster you drive. Higher steering precision and enhanced road feedback are easily enjoyed benefits. At lower speeds, added power assistance makes the car even easier to maneuver, for instance when parking.

Brakes

Power-assisted anti-lock ventilated disc brakes (ABS). EBA (Emergency Brake Assistance). EBD (Electronic Brake Distribution) between the front and rear brakes. Diagonally split braking system.

PERFORMANCE Engine

Six-cylinder engine

Six-cylinder in-line 3.2-litre all-aluminium engine. Double overhead camshafts, 24 valves. Variable Cam Timing (VCT), Variable Intake System (VIS) and Cam Profile Shifting (CPS) on the intake camshaft. Electronic engine management system. Three-way catalytic converter with heated oxygen sensor.

Volvo XC90 3.2 AWD (235 hp)

Engine type: 3.2-litre in-line six-cylinder engine
 Max power output: 240 hp at 6200 rpm
 Max torque: 236 lb-ft. at 1500–4500 rpm
 Top speed: 210 km/h
 Fuel consumption, N/A
 Environmental classification: ULEV II
 Transmission: Six-speed Geartronic automatic
 Fuel tank: 80 litres

TAKING CARE OF YOUR OWNERSHIP NEEDS.

VOLVO LEASING AND FINANCING OFFERS.

Special offers are available to finance your new Volvo product through our preferred provider, Scotia Bank. Whether you are looking for the convenience of a lease or the pride of owning your Volvo vehicle, our nationwide network of retailers and authorized financial service providers are ready to assist you with all your financing needs. Please contact your local retailer for details .

On Call roadside assistance.

Whenever you need us, we're just a phone call away. Our nationwide network of retailers and authorized service providers are ready to assist. Whether you require roadside assistance or maps and routing information for your next trip, refer to your On Call Card and dial 1-800-263-0475 – anytime, day or night. Your complimentary four-year membership activates the moment you become a Volvo owner.

Volvo new car warranty.

Your new car warranty provides comprehensive coverage for four years or 80,000 kms, whichever occurs first. Additional warranties cover corrosion, seat belts, the supplemental restraint system, emission systems, genuine Volvo replacement parts and genuine Volvo accessories. Should you encounter any problem with your Volvo, simply contact the nearest retailer for assistance. Where your warranty ends, Volvo Increased Protection (VIP) plans begin. To purchase the additional protection of a VIP plan, contact your local retailer.

Volvo service for life.

Taking the concept of service to a new level.

- Two-year Parts Warranty. Including the labour when they're installed at an authorized Volvo retailer
- Complimentary Software Updates during a scheduled maintenance visit. New software required as part of repair or accessory installation is not included
- Complimentary Vehicle Diagnostics if your Volvo has a "check engine" lamp or other warning indicator illuminated. Up to an hour of computer diagnostics
- Special discounted On Call Roadside Assistance pricing. Visit your retailer for enrollment form

Volvo mobility program.

The goal of the Volvo Mobility Program is to assist persons with physical disabilities or hearing impairment. For those with exceptional transportation needs, this can be facilitated within the extraordinary comfort and safety of a specially adapted Volvo. For additional information on this program please see your local participating Volvo retailer or Volvo Car Canada Customer Relations at 1-800-663-8255.

VOLVO EUROPEAN DELIVERY.

Bring home an unforgettable overseas experience.

European Delivery, as part of Volvo Cars International Travelers Program, is a unique way to buy your custom-built Volvo as well as a unique way to see more of Europe. You can collect your new custom-built Volvo in Sweden, drive it while exploring your favourite destinations and then have it delivered in Canada after your return. And that is not all the program offers. You'll experience a variety of added incentives including two complimentary round-trip tickets and the opportunity of our special VIP Factory Delivery experience in Gothenburg, Sweden, the home of Volvo.

Purchase any new Volvo, take delivery in Sweden and enjoy all this and more

- Two complimentary round trip tickets to Gothenburg, Sweden
- One free hotel night for two in Gothenburg
- VIP delivery at the home of Volvo including our exciting Factory Tour
- The opportunity to explore Europe in your own Volvo
- 15 days International Insurance and Export registration
- Complimentary home shipment of your new Volvo to your authorized Volvo retailer in Canada
- 6.1% import duty included

The beauty of Scandinavia, French country roads, the thrills of the German autobahns, breathtaking alpine passes – it's all yours to discover. For an even more inspiring journey, travel in the comfort and safety of your own Volvo. And when you're done travelling, bring the pleasure of driving a Volvo back home. Can you think of a better way of travelling overseas and making your souvenir part of an unforgettable experience?

VOLVO CARS EXPATRIATE SALES.

Are you moving abroad, living abroad, moving home or to a new country? If so, take advantage of the Volvo Cars Expat Sales program. Wherever you are stationed, our specialized and highly professional organization is there to guide you to the most convenient way to solve your car needs while abroad – and to buy your favourite Volvo model on special terms. Everybody's situation is different. If you are a Canadian Citizen temporarily living abroad we'll be happy to make your car purchase as simple as possible. Just get in touch (select Retailers) and our expert specialists will advise and assist you with all details or guide you to the correct source of information.

Your Personal Benefits Program

- Competitive expat pricing, savings and offers
- Extensive and customized delivery services
- Free shipment from Gothenburg, Sweden to an authorized Volvo retailer of your choice in Canada (from other locations a transfer charge will apply)
- Round-the-clock road assistance in Europe
- On Call service in Canada
- International warranties
- Swedish export registration and insurance. Subject to local regulations
- Option of VIP Factory Delivery experience
- Worldwide service network

For more information visit expat.volvocars.com

Canadian Fleet Sales

Volvo Cars of Canada is committed to providing your organization with a Premium Fleet Experience. Our core values of safety, quality and environmental care are the essence of our brand, and our dedication to these values allows us to build world-class automobiles that meet the needs of today's demanding fleet decision-makers and drivers. Our Premium Fleet Experience enhances customer treatment and satisfaction by providing consistent order-to-order delivery times with priority order placement at the factory, direct-order relationships with major fleet leasing companies, and premium courtesy delivery via Volvo Retailer that is convenient to the driver's location. Each Volvo offers a unique driving experience. We trust the Volvo you choose to best fit your fleet needs is better than anything you've driven before. For Sales people, Managers or Executives, Volvo range offers a large selection of models that perfectly matches your drivers' needs.

For more information, please contact us at:

Fleet Sales: (416) 493-3700 ext 5208

Fax: (416) 493-8754

Email: canfleet@volvocars.com

WELCOME TO THE CLUB. THE VOLVO XC90 MERCHANDISE COLLECTION.

This smart collection of lifestyle accessories captures the driving spirit of your new Volvo and reflects the best of modern Scandinavian design. The signature items below are a select few. Find more keepsakes, gifts and apparel at your local Volvo showroom and at www.volvocars.ca



Ceramic Mug



Sports Duffel



Metal Pen



Men's/Ladies' Watch



Compact Umbrella



SHOX Mini Speaker



Recycled Fashion Tote



Stainless Steel Water Bottle