



2013

SEDAN/HATCHBACK



SX4



Way of Life!



The Attraction is Natural

The 2013 Suzuki SX4 Sedan is ready to prove it has what it takes. Made clear from the moment you lay eyes on the smooth European styling, it has a look all of its own. Have a seat in the well-appointed interior. Combine this with the sheer driving experience that only a highly responsive, European-tuned sport suspension can deliver. With variable valve timing (VVT) plus your choice of a 6-speed manual transmission or the continuously variable transmission (CVT), the 2013 SX4 Sedan is both fuel efficient and fun to drive! And let's not forget that all of these built-in features plus an impressive list of others, are made available at a price that won't break the bank. The end result is an impressive vehicle that defines success.

SX4 Sport model shown.

The Journey of a Lifetime

SX4 Sedan - Japanese quality, European drive and handling, North American spaciousness. Once the goal is in sight, there are those who rush to the first opportunity and those who take the time to select the right path. Never one to waste time showing off, you still know the importance of setting yourself apart. This makes the SX4 Sedan the perfect complement to the way you choose to live your life. As smart as it is stylish, the SX4 Sedan understands that enjoying the ride is as important as the final destination.



SX4 SEDAN

- Fun to drive European-tuned sport suspension
- Loaded with standard features

Advanced Audio System with Garmin Navigation



TouchFree Smart Key
When you approach, SX4 senses your TouchFree Smart Key™ allowing you to open your locked door and start your vehicle without ever removing the key from your pocket or purse. Standard on Sport.

The multimedia infotainment system offers a host of advanced features including easy-to-use navigation with award-winning software, fuel-saving route guidance, millions of points of interest, full iPod integration, Bluetooth wireless technology, and an audio system that lets you listen to AM/FM radio, audio files on an SD card or USB drive, CDs, and Bluetooth-capable audio devices. All controlled hands-free with voice commands or through the integrated 6.1" colour touch-screen. Standard on Sport.



Steering Wheel-Mounted Audio Controls
Keep your eyes on the road with the help of steering wheel-mounted controls. This feature puts control of the audio system and your mobile phone at your fingertips. Standard on Sport.

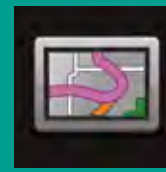

6.1" colour touch-screen navigation



Hands-free calling and streaming audio



Voice Command

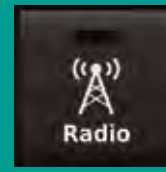

Advanced audio system

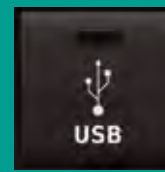

USB input with iPod integration

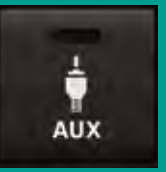

Auxiliary audio input jack



It's not where you go, but how much fun you have along the way.

Joy, excitement, adventure. This is what driving happiness is all about, and it's exactly the feeling you get when you sit behind the wheel of the Suzuki SX4. It's a car that makes you want to fill up the tank, pick a point on the map and go. A car built with the belief that a well-equipped ride doesn't have to break the bank.



SX4 HATCHBACK

- Fun to drive European-tuned sport suspension
- Loaded with standard features
- Unique design combines sporty performance with SUV versatility



Where the Advantage Begins

From the outside, the SX4 continues to exceed expectations. With smooth curves and sleek, sophisticated styling, it gets the looks. Compact and manoeuvrable enough to navigate narrow spaces, it makes parking and getting around the city a breeze, while still being spacious enough to carry all you need for a day out or a weekend getaway. Wherever your travels may take you, the SX4 invites all passengers to experience a ride in thoughtful, refined comfort.



Illuminated information cluster and panel
Blue and red lights integrate your driving space to conveniently reveal not only your speed but also the outside temperature, fuel consumption and fuel range remaining.



Standard air conditioning with automatic climate control
In the Sport model you'll enjoy the convenience of automatic climate control well positioned for both the driver and front passenger, making it easy to adjust interior conditions exactly to your liking.

Always looking out for you



2.0-litre VVT engine

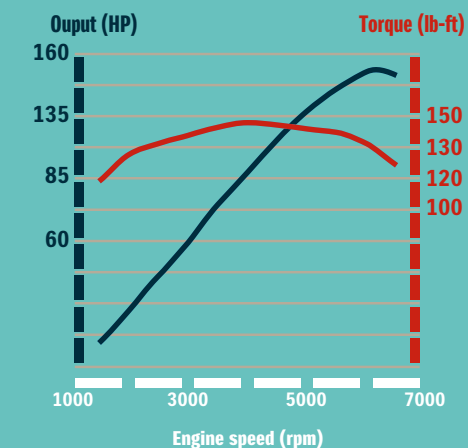

2.0-litre 16-valve DOHC VVT with 150HP
The SX4 powertrain delivers high-energy excitement from the moment you start the ignition. At low ranges the variable valve timing (VVT) puts out ample torque for immediate responsiveness and quick acceleration that never feels sluggish. As the rev rate increases, the valve timing continuously varies to enable more effective fuel combustion and efficiency, putting all the power at your command.

Passive safety systems are ready when you need them

The SX4 also watches over you with passive safety systems. The rigid frame directs impact energy around the cabin and away from occupants, while crumple zones absorb and dissipate collision energy before it can reach the interior. The front seats are equipped with three-point ELR seat belts with pre-tensioners and force limiters. The rear seats are equipped with right, left and centre three-point ELR seat belts.

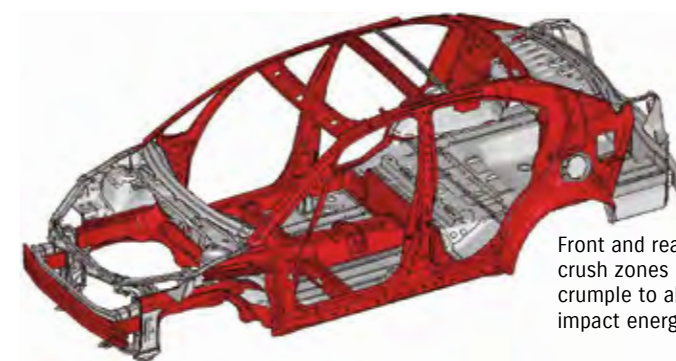

Front and rear crush zones crumple to absorb impact energy



4-wheel disc brakes with ABS
4-wheel disc brakes add to the standard anti-lock brakes (ABS) with brake assist and electronic brake-force distribution (EBD) functions.

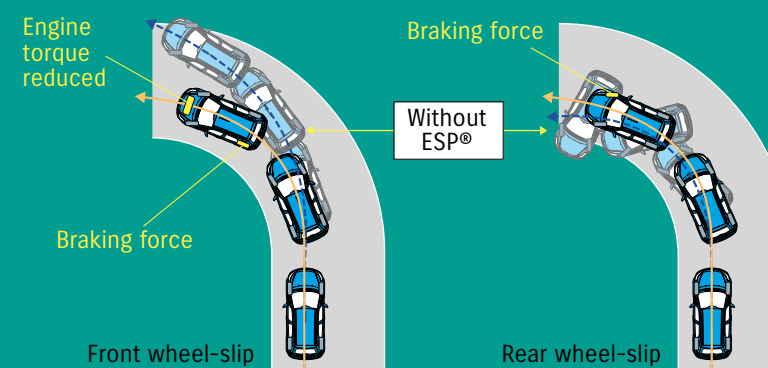

ESP® control system
Standard on all models, ESP® (Electronic Stability Program) supplements the Suzuki SX4's inherent stability with three major functions: ABS with EBD, traction control and stability control. ESP®'s Electronic Control Unit (ECU) uses various sensors to determine and hold the cornering line, greatly increasing traction and stability control while reducing front and rear wheel-slip for enhanced safety.

← With ESP®
→ Without ESP®

Preventive measures
SX4 is designed to provide the driver with ample visibility to all sides by elevating the driver's seat position and minimizing blind spots. The eight-airbag system combining two front airbags, front and rear side airbags and left and right curtain airbags comes standard to help prevent injury in the event of a collision.



Note: The SRS airbags are shown inflated for illustrative purposes

ACCESSORIES: Exterior

WINDOW VISOR SET

Window Visors help keep out the wind and rain while allowing fresh air in. Made of tough, durable acrylic for aerodynamic style and function. Set of 4.



MULTI ROOF RACK

Enhance the versatility of your Suzuki with Genuine Suzuki Accessories Roof Racks and Modules. Produced for Suzuki by one of Europe's leading manufacturers of racks and modules, Mont Blanc®. Stylish racks and modules can provide added cargo capacity and installs quickly and easily to meet your lifestyle needs. NOTE: Total Weight must not exceed 45 kg (100 lbs).



REAR BUMPER PROTECTORS

Help protect your rear bumper from minor nicks and scratches, applies easily with adhesive backing.



HOOD PROTECTORS

Aerodynamically designed Hood Protector is moulded from scratch resistant, high impact, UV resistant acrylic. Air-flow redirection helps deflect bugs away from the windshield. Helps protect the hood surface from minor scratches. Installs easily with no drilling required.



Interior

ALL WEATHER FLOOR MATS

Rubberized vinyl all weather mats are designed with edge lip to help keep dirt and other debris away from your SX4's interior. Cleans easily with mild soap and water. SX4 mats are lightweight and install or remove in seconds. Front and rear.



CARGO SECURING NETS, VERTICAL ENVELOPE

Handy and inexpensive Cargo Securing Nets provide a convenient way to help secure items in the cargo area.



SPORT PEDAL SET

Add a sporty look to your vehicle with the Sport Pedal Set. Made of lightweight aluminum and non-slip rubber inserts, it offers a highly polished look with engraved Suzuki logo.



DOOR SILL TRIM

Door Sill accents are made of real carbon fibre weave material with an exterior-grade urethane top coat and screened SX4 logo. Available in carbon fibre (Grey) or a brushed aluminum finish to coordinate or contrast with the SX4 interior.

Installs in minutes.



MORE ACCESSORIES: Exterior

BODY SIDE MOULDINGS - LARGE

Durable polyurethane moulding sets help protect your paint. Mounts quickly and easily with durable double-sided adhesive strips. Set of 4.



REAR UPPER SPOILER (HATCHBACK)

Moulded in sturdy, lightweight polyurethane. Includes complete instructions and necessary hardware for installation (requires drilling).



ADDITIONAL ACCESSORIES

	SEDAN			HATCHBACK	
	JE	JA	SPORT	JA	JX
TRUNK MAT	X	X	X		
FOG LAMP KIT	X	X		X	X
REAR STORAGE BAG SYSTEM	X	X	X	X	X
WHEEL LOCK SET	X	X	X	X	X
VALVE STEM CAPS	X	X	X	X	X
REAR HATCH EDGE MOULDING				X	X
SKID PLATE TRIM REAR					X
SPLASH GUARDS, MOULDED STYLE	X	X			
SPLASH GUARDS, PLATE STYLE			X		X

For full Accessories listings see your Suzuki dealer or www.suzuki.ca



SUZUKI SECURE ADVANTAGE PROTECTION: We are proud to deliver each 2013 Suzuki with Suzuki Secure Advantage Protection warranty coverage at no additional cost. The Suzuki Secure Advantage Protection plan features a 5-year/100,000 kilometre Powertrain Warranty, a 3-year/60,000 kilometre New Vehicle Limited Warranty and a 5-year unlimited mileage Anti-Perforation warranty. All warranties are zero deductible and fully transferable at no cost. **ROADSIDE ASSISTANCE:** For added peace of mind, SUZUKI SECURE ADVANTAGE PROTECTION includes numerous roadside assistance benefits. Wherever you may be in Canada or the continental United States, should you require roadside service for towing due to collision or mechanical problems, battery boost, if you have run out of fuel, or locked your keys in your car, have a flat tire or require winching or extrication to get you back on the road, Suzuki Secure Advantage Roadside Assistance has you covered, at no additional cost to you. Just call our toll-free number and a bilingual Suzuki Secure Advantage Roadside Assistance counsellor will help you on your way, 24 hours/day, 365 days/year. This plan also features Trip Interruption benefits so if you are more than 100 kilometres from home and your vehicle is undrivable for any reason, you can make alternate arrangements and request reimbursement for expenses incurred within 3 days and up to \$300. Suzuki Secure Advantage Roadside Assistance covers your 2013 Suzuki for 3 years with no mileage limitations. **SUZUKI PROTECTION PLAN:** Should you plan to drive your new Suzuki farther or longer than the coverage provided by the Suzuki New Vehicle Limited Warranty, the Suzuki Protection Plan will be of special interest to you. Suzuki Protection Plan provides you with the ability to enhance and extend coverage already provided by the new vehicle limited warranty. Suzuki Protection Plan offers you affordable, cost-effective peace of mind in the event of unexpected mechanical failure or other roadside

emergencies for up to 7 years or 140,000 kilometres. Suzuki Protection Plan offers a vast choice of coverage levels, terms and deductibles allowing you to select the specific plan best suited to your ownership requirements. Ask your Suzuki dealer for a complete explanation of the benefits, coverages, limitations and exclusions of Suzuki Protection Plan, to better assist you in choosing the coverage that best suits your needs. The Suzuki Logo, Suzuki, Kizashi, Grand Vitara and SX4 are registered trademarks of Suzuki Motor Corporation of Japan. **DRIVE RESPONSIBLY. BUCKLE UP FOR SAFETY—DON'T DRINK AND DRIVE.** Specifications and equipment based on information available at time of printing and subject to change without notice, and may differ in each sales area. Some vehicles shown with optional equipment. Colours shown may vary from actual colours. For more details on 2013 options, accessories and specifications, contact your local Suzuki dealer. †To avoid injury from an inflating airbag always place children twelve years old and under in the rear seat. Always move both driver and passenger seats as far back from airbags as practical; never transport a child in a rear-facing seat in the front seat. Always use the seat belts and buckle up properly. Fuel economy estimates are determined by using Transport Canada approved testing methods. All other trademarks and copyrights are the property of their respective owners. XM Radio: Required XM® tuner and subscription sold separately. Subscriptions subject to customer agreement available at xmradio.com. The XM name is a registered trademark of XM Satellite Radio, Inc. ©2013 Suzuki Canada Inc. Printed in Canada. 11/12

For full Accessories listings see your Suzuki dealer or www.suzuki.ca

2013 SX4 Sedan and Hatchback

Features & Specifications

COMFORT	Sedan			Hatchback	
	JE	JA	SPORT	JA	JX
Power steering	S	S	S	S	S
Power windows with driver's express down	S	S	S	S	S
Power door locks	S	S	S	S	S
2-stage remote keyless entry with panic function	N/A	S	S	S	S
SmartPass™ keyless entry and start system	N/A	N/A	S	N/A	N/A
Air conditioning	N/A	S	S	S	S
Automatic climate control	N/A	N/A	S	N/A	N/A
Sound System	AM/FM/CD/MP3/WMA player (4 speakers) Speaker pre-wire only	S	N/A	S	S
	AM/FM stereo with Garmin® navigation - includes AM/FM stereo, CD player MP3/WMA, 6.1" colour touch-screen interface display, voice commands, USB iPod® integration, SD card support, and streaming audio via Bluetooth**	N/A	N/A	S	N/A
	Dashboard centre mounted speaker	N/A	N/A	S	N/A
	Bluetooth hands-free phone integration	N/A	N/A	S	N/A
	Illuminated steering wheel-mounted audio controls	N/A	N/A	S	S
	Auxiliary audio input jack	N/A	S	S	S
	Digital clock	N/A	S	S	S
	Speed sensing volume control	N/A	S	S	S
	XM® satellite radio ready (optional receiver & antenna required)	N/A	S	S	S
	Cruise control with steering wheel-mounted controls	N/A	N/A	S	S
INSTRUMENT PANEL					
Tachometer	S	S	S	S	S
Door ajar warning lamps	S	S	S	S	S
Seat belt reminders (driver & front passenger)	S	S	S	S	S
Information display (outside temperature, fuel consumption & range)	S	S	S	S	S
Light-off/key reminder	S	S	S	S	S
Low fuel warning indicator	S	S	S	S	S
Leather-wrapped steering wheel	N/A	N/A	S	N/A	S
Steering lock	S	S	S	S	S
Tilt steering	S	S	S	S	S
Paddle shifters	N/A	N/A	S (w/ CVT)	N/A	N/A
INTERIOR					
Centre cabin light with fade-out (3 position)	S	S	S	S	S
Height-adjustable driver's seat	S	S	S	S	S
Driver and front passenger seat-mounted armrests	S	S	S	S	S
Passenger seatback pocket	S	S	S	S	S
Heated front seats	N/A	N/A	S	N/A	N/A
Split-folding rear seatbacks (60/40)	S	S	S	S	S
Rear cargo light (2 position)	N/A	N/A	N/A	S	S
Trunk light	S	S	S	N/A	N/A
Front map lights	S	S	S	S	S
Floor mats (front & rear)	S	S	S	S	S
Sun visors with vanity mirrors	S	S	S (with Extenders)	S	S
Cup holders (2 front/1 rear)	S	S	S	S	S
Bottle holders (2 front/2 rear)	S	S	S	S	S
Day/night rear view mirror	S	S	S	S	S
Reclining front seats	S	S	S	S	S
Front and rear head restraints (2/3)	S	S	S	S	S
Front and rear door armrests	S	S	S	S	S
Assist grips (2 front/2 rear)	S	S	S	S	S
Front/rear door pockets	S	S	S	S	S
Accessory power outlet	S	S	S	S	S
Cargo area cover	N/A	N/A	N/A	S	S
Rear cargo storage pocket	N/A	N/A	N/A	S	S
Driver's footrest	S	S	S	S	S
EXTERIOR					
Halogen headlights	S	S	S	S	S
Aero body kit - body-coloured front & rear valances, side sill extensions	N/A	N/A	S	N/A	N/A
Electric rear hatch release	N/A	N/A	N/A	S	S
Wheel arch extensions	N/A	N/A	N/A	N/A	S
Side skirts	N/A	N/A	N/A	N/A	S
Rear spoiler	N/A	N/A	S	N/A	N/A
Power mirrors	S	S	S (Heated)	S	S (Heated)
Variable intermittent wipers	S	S	S	S	S
Rear window wiper/washer with fixed intermittent	N/A	N/A	N/A	S	S
Rear window defroster with timer	S	S	S	S	S
Remote fuel door release	S	S	S	S	S
Electric trunk release	N/A	N/A	S	N/A	N/A
Remote trunk release	S	S	S	N/A	N/A
Body-coloured bumpers/mirrors/door handles	S	S	S	S	S
Roof rails	N/A	N/A	N/A	N/A	S (black)
Tinted glass	S	S	S	S	S
Fog lamps	N/A	N/A	S	N/A	N/A
Wheel covers	S	S	N/A	S (15 inch)	N/A
Aluminum alloy wheels	N/A	N/A	S (17 inch)	N/A	S (16 inch)
SAFETY AND SECURITY					
Engine block heater	S	S	S	S	S
Dual front airbags¹	S	S	S	S	S
Front/rear seat-mounted side airbags¹	S	S	S	S	S
Side-curtain airbags¹	S	S	S	S	S
ESP*** (Electronic Stability Program)	S	S	S	S	S
ABS with Brake Assist and EBD (Electronic Brake-Force Distribution)	S	S	S	S	S
Engine immobilizer	S	S	S	S	S
3-point ELR seat belts (for all 5 seating positions)	S	S	S	S	S
Pre-tensioners for front seat belts	S	S	S	S	S
Centre high-mounted rear stop lamp	S	S	S	S	S
Childseat tether anchorage (3 rear)	S	S	S	S	S
ISO-FIX LATCH childseat safety seat provisions (2 rear)	S	S	S	S	S
Height-adjustable front seat belt anchors	S	S	S	S	S
Daytime running lights	S	S	S	S	S
Child-proof rear door locks	S	S	S	S	S
Side impact beams	S	S	S	S	S

*iPod® is a registered trademark of Apple Computer, Inc. All rights reserved. **Bluetooth is a registered trademark of Bluetooth SIG Inc.
 ***ESP is a registered trademark of Daimler AG. 'Garmin®' is a registered trademark of Garmin Ltd.
 S: Standard Opt: Optional N/A: Not Available

EXTERIOR DIMENSIONS	Sedan				Hatchback	
	JE/JA 6MT	JA CVT	SPORT 6MT	SPORT CVT	JA 6MT	JX CVT
Overall length	mm (inch)	4,490 (176.8)		4,510 (177.6)	4,135 (162.8)	4,150 (163.4)
Overall width	mm (inch)	1,730 (68.1)		1,730 (68.1)	1,730 (68.1)	1,755 (69.1)
Overall height	mm (inch)	1,545 (60.8)		1,545 (60.8)	1,575 (62.0)	1,605 (63.2)
Wheelbase	mm (inch)	2,500 (98.4)		2,500 (98.4)	2,500 (98.4)	2,500 (98.4)
Tread	mm (inch)	1,500 (59.1)		1,500 (59.1)	1,500 (59.1)	1,500 (59.1)
	mm (inch)	1,495 (58.9)		1,495 (58.9)	1,495 (58.9)	1,495 (58.9)
Ground clearance	mm (inch)	165 (6.5)		160 (6.3)	165 (6.5)	175 (6.9)
Minimum turning radius	m (ft)	5.3 (17.4)		5.3 (17.4)	5.3 (17.4)	5.3 (17.4)
Seating capacity	persons	5		5	5	5
INTERIOR DIMENSIONS						
Head Room	mm (inch)		1,006 (39.6)		1,006 (39.6)	
	mm (inch)		953 (37.5)		964 (38.0)	
Leg Room	mm (inch)		1,051 (41.4)		1,051 (41.4)	
	mm (inch)		909 (35.8)		924 (36.4)	
Shoulder Room	mm (inch)		1,355 (53.3)		1,355 (53.3)	
	mm (inch)		1,341 (52.8)		1,341 (52.8)	
Hip Room	mm (inch)		1,296 (51.0)		1,296 (51.0)	
	mm (inch)		1,083 (42.6)		1,186 (46.7)	
Cargo Index	litres (ft³)		439 (15.5)			
Cargo Length	mm (inch)				446 (17.6)	
	mm (inch)				1,226 (48.3)	
Cargo Width	mm (inch)				938 (36.9)	
Cargo Height	mm (inch)				891 (35.1)	
Luggage Capacity	litres (ft³)				203 (7.2)	
	m³ (ft³)				1,465 (51.8)	
ENGINE						
		2.0 litre DOHC 16 valve inline 4 cylinder with VVT (Variable Valve Timing)			2.0 litre DOHC 16 valve inline 4 cylinder with VVT (Variable Valve Timing)	
Number of cylinders		4			4	
Number of valves		16			16	
Piston displacement	cc	1,995			1,995	
Compression ratio		10.2 : 1			10.2 : 1	
Maximum output	hp @ rpm	150 @ 6,200			150 @ 6,200	
Maximum torque	lb.ft. @ rpm	140 @ 4,000			140 @ 4,000	
Fuel distribution		Sequential multi point fuel injection			Sequential multi point fuel injection	
TRANSMISSION						
Type		6MT		CVT w/manumatic control (N/A JE/Opt JA and SPORT)	6MT	CVT
Gear ratio	1st	3.615			3.615	
	2nd	2.047			2.047	
	3rd	1.379			1.379	
	4th	1.029			1.029	
	5th	0.837			0.837	
	6th	0.707			0.707	
	Reverse	3.481			3.481	
Final gear ratio		4.117		1.750	4.117	1.750
				5.798		5.798
WEIGHTS						
Curb weight (min.)	kg (lbs)	JE: 1,238 (2,730) JA: 1,251 (2,759)	1,296 (2,858)	1,295 (2,855)	1,340 (2,956)	JA: 1,218 (2,686) JA: 1,263 (2,785) JX: 1,278 (2,818)
Gross vehicle weight	kg (lbs)	1,715 (3,781)	1,715 (3,781)	1,715 (3,781)	1,715 (3,781)	1,715 (3,781)
FUEL CONSUMPTION						
Fuel tank capacity	litres	50	50	50	50	50
Fuel economy	L/100 km (mpg) (City/Highway)	9.0/6.0 (31/47)	8.0/6.1 (35/46)	9.1/6.2 (31/46)	8.9/6.7 (32/42)	JA: 9.1/6.3 (31/45) JA: 8.2/6.4 (34/44) JX: 8.8/6.7 (32/42)

EXTERIOR/INTERIOR COLOURS - Sedan



Quicksilver Metallic
JE, JA, Sport
Interior: Dark Grey

Indigo Blue Pearl
JA, Sport
Interior: Dark Grey

Mineral Grey Metallic
Sport
Interior: Dark Grey

Polar White
JA, Sport
Interior: Dark Grey

Blaze Red Pearl
Sport
Interior: Dark Grey

EXTERIOR/INTERIOR COLOURS - Hatchback



Indigo Blue Pearl
JA, JX
Interior: Dark Grey

Mineral Grey Metallic
JA, JX
Interior: Dark Grey

Copper Pearl Metallic
JX
Interior: Dark Grey

Polar White
JA, JX
Interior: Dark Grey



Kizashi iAWD



Grand Vitara 4WD



SX4 Crossover iAWD



SX4 Sedan



SX4 Hatchback

2013



suzuki.ca



40013-SX4FW-ENG