

OPEL VIVARO





DESIGNED TO GET WORK DONE.

The Opel Vivaro has everything it takes to get the job done. The presence of a front-line flagship, a comfortable cabin and spacious load area. Reliability, fuel economy and FlexCare after-sales support mean your Vivaro's always ready to put in a shift.

// Exceptional **LOW COST** of Ownership

// Stylish **DESIGN AND PRESENCE** for a strong company image

// Variants and **VERSATILITY** for different business needs

// **FLEXCARE** keeps your van on the road longer

// Comprehensive financing delivers **EXCELLENT VALUE** for money

The contents of this catalogue were accurate at the time of going to print (03/2015). We reserve the right to alter specifications and equipment at any time. Please consult your Opel dealer for the very latest information.

CONTENTS

Please check and adjust index

OPEL VIVARO	04	THE VIVARO
		MODELS
	16	PANEL VAN
	22	CREW VAN
	26	COMBI
	34	PLATFORM CAB
		INNOVATIONS
	36	MOBILE OFFICE
	38	SAFETY AND INFOTAINMENT
	40	CARGO AND COMFORT
	42	ACCESSORIES
	44	VARIANTS
	46	ENGINES AND TRANSMISSIONS
	48	ECOFLEX TECHNOLOGIES
	50	TRIMS AND SURFACES
	52	PAINTS AND WHEELS
	54	OPEL SERVICE
	58	HIGHLIGHTS

YOU HAVE THE TASK. WE HAVE THE TOOL.





FIRST IMPRESSION: FIRST CLASS.

The Vivaro is the model professional. Confident styling and quality workmanship prove your business means business.

- // OUTSTANDING DESIGN makes an impressive business card
- // **Four** CUSTOMIZABLE BODY TYPES cater to varied needs
- // PANEL VAN for payloads large and small
- // CREW VAN for SIX PEOPLE plus a sizeable payload
- // Combi with flexible seating for up to NINE PEOPLE
- // Platform cab as base for UNIVERSAL CONVERSIONS





F GG 9028





BUILT TO ADAPT.

The best tradesmen deserve the best tools. So Opel made the Vivaro a comfortable place to get things done. A wide range of options lets you customize the cabin and transform your van.

// Versatility for MAXIMUM PRODUCTIVITY

// INTERIOR ADAPTS to people and cargo

// OFFICE BENCH SEAT with clipboard, desk and storage

// Driver's seat with ARMREST and lumbar support

// ADJUSTABLE STEERING WHEEL, for rake and reach

For more information, turn to pages **XX-XX**.

**Note to countries: Please check all page references carefully and change if need be.
In the master version this refers to page 30 and 36 (Your out of office/growth potential).**



PAYLOAD THAT PAYS OFF.

If you've bulk goods to move, the Vivaro's your van. The Panel Van comes with two wheelbases and two roof heights and is sturdy, reliable, variable – and spacious.

// HEAVY PAYLOAD up to 1,2 tonnes

// LONG CARGOES up to 2.537 mm or 2.937 mm

// LOAD WIDTH between wheel arches 1.268 mm

// 5,2 m³ to 8,6 m³ MAXIMUM LOAD VOLUME

// Even short version takes **THREE EURO-PALLETS**

// BULKHEAD HATCH extends load length to 4,15 m

For more information, turn to pages **XX** and **XX**.

Image may show optional equipment not available from Opel.









SAVING BY DOING.

Class-leading efficiency boosts your profits and low emissions give the environment a lift. **Low** Total Cost of Ownership means your Vivaro can increase your income.

- // Among BEST-IN-CLASS consumption and emissions
- // Low-displacement turbos for INCREASED EFFICIENCY
- // Advanced **BITURBO** ENGINES available
- // **ECO MODE** for optimal fuel economy

For more information, turn to pages **XX-XX**.

SAFETY AT WORK.

Peace-of-mind is a must in the workplace, so safety comes first in the Vivaro. Powerful technologies protect your people, your property and your company.

// ESP® CONTROL in difficult conditions

// TRACTION CONTROL enhances grip

// ADAPTIVE LOAD CONTROL considers payload

// HILL START ASSIST for safer starts

// TRAILER SWAY ASSIST¹ for trailer stability

// BLIND ANGLE MIRROR for improved visibility

// POWERFUL HEADLAMPS

For more information, turn to page **XX**.

¹In combination with optional trailer hitch.





F GG 90



PANEL VAN.

Versatility, power, variants and options. The Vivaro Panel Van with standard roof height has them all.

PANEL VAN STANDARDS INCLUDE

- // Two wheelbases
- // 2.537 mm or 2.937 mm load lengths
- // Up to 1.199 kg payload
- // Easy-access, 1 m wide passenger-side sliding door
- // Twin rear doors open up to 180°
- // Side and rear doors take a euro-pallet with ease
- // Floor-mounted, load-securing eyes
- // Powerful, efficient 1.6 litre CDTI diesel engines

Images may show optional equipment.



1. LOAD-SPACE OPTIONS. Plastic-coated plywood cladding and a resin-coated floor help protect the Panel Van and its cargo, FlexCargo® bulkhead extends load lengths up to 4,15 m.

2. OPTIONAL REAR DOORS THAT OPEN 250°. For safe, easy loading, the doors fold back and fasten to the side of the van.



PANEL VAN HIGH ROOF.

Higher and mightier. The Vivaro Panel Van with space to make easy work of bulky loads.

PANEL VAN HIGH ROOF STANDARDS INCLUDE

- // Versatile 1.897 mm load height
- // Two wheelbases
- // Load volume 7,2 m³ with 2.537 mm load length
- // 8,6 m³ load volume with 2.937 mm load length
- // Full-height doors open up to 180°
- // Side sliding door takes a euro-pallet
- // Floor-mounted, load-securing eyes
- // Up to 1.151 kg payload

Images may show optional equipment.



FULL STANDING HEIGHT. Extra height, easy access and plenty of space means the Vivaro high-roof versions not only carry larger loads, they also make the perfect mobile workshop.

PANEL VAN TRIM LEVELS.

The Panel Van is a power player with excellent spec.

PANEL VAN CHOICES

- // Two wheelbases
- // Two roof heights
- // Ample load space up to 8,6 m³
- // Payload up to 1,2 tonnes
- // Secure steel or glazed bulkhead
- // Glazed or unglazed rear and side doors
- // Rear swing doors or a tailgate
- // Heated rear window with wipers

For more information, turn to page **XX**.



Images may show optional equipment.

¹ Not available on Panel Van Essentia. Optional on Panel Van Edition. Standard on Panel Van Sportive.

1. **FOLD-DOWN CONVERTIBLE OFFICE BENCH SEAT¹.** The centre seat has a removable clipboard that can stand vertical while the seat back converts into a desk for a laptop. Both seat cushions also flip up to reveal 42 litres of built-in storage.

2. **LEATHER STEERING WHEEL WITH CRUISE CONTROL.** For safer, more comfortable driving all day.

3. **LARGE GLOVE BOX.** With plenty of space for A4 documents.

4. **FRONT FOG LAMPS.** See and be seen.

PANEL VAN ESSENTIA.

THE FOLLOWING FEATURES COME STANDARD:

- // 16" steel wheels with centre cap
- // Daytime Running Lights (halogen)
- // Steel bulkhead
- // Remote central door locking
- // Electric windows
- // Front passenger bench
- // Radio installation kit
- // 12-V dashboard socket
- // Driver airbag
- // Tricess Blue trim fabric
- // Dashboard in Denim Blue

PANEL VAN EDITION.

ALL THE FEATURES OF THE ESSENTIA, PLUS:

- // R16 radio with Bluetooth® and USB input
- // Electrically adjustable, heated side mirrors
- // 6-way adjustable driver's seat with armrest, lumbar support
- // 12-V socket in load space
- // Exterior temperature display
- // Large glove box with lid
- // Cover for centre of wheel

4.



PANEL VAN EDITION PLUS ELEGANCE PACK.

ALL THE FEATURES OF THE EDITION, PLUS:

- // 16" steel wheels with full cover
- // Front and rear outer bumpers in body colour
- // LED Daytime Running Lights
- // Connect Black Embossed trim fabric
- // Dashboard in Carbon Black
- // Leather-wrapped steering wheel
- // Cruise control with speed limiter
- // Front fog lamps

PANEL VAN SPORTIVE.

ALL THE FEATURES OF THE EDITION PLUS ELEGANCE PACK, PLUS:

- // Side mouldings, rear bumpers and mirrors in body colour
- // Remote selective door locking
- // CD18 CD radio with Bluetooth® and USB
- // Office bench seat with load-through compatibility
- // Leather steering wheel with cruise control
- // Air conditioning
- // Park Pilot
- // Chrome grille



CREW VAN.

The Crew Van gives you space and fast access.
For your teams and their tools.

CREW VAN STANDARDS INCLUDE

- // Comfortable seating for up to six adults
 - // Welcoming three-seater second-row bench
 - // Generous rake on second-row seats
 - // Smart trim for an appealing interior
 - // Reinforced bulkhead
 - // Up to 4,0 m³ adaptable load space
- For more information, turn the page.

Images may show optional equipment.



SLIDING SIDE DOOR. The extra-wide opening puts rear-seat passengers at their ease from the start. It provides uncluttered access to the three comfortable seats that make up the bench in the back.

CREW VAN TRIM LEVELS.

The Vivaro Crew Van seats up to six in comfort. Heavy gear can be safely stowed behind the bulkhead.

CREW VAN CHOICES

- // Two wheelbases: 3,098 m or 3,498 m
- // Three-seater second-row bench with armrests
- // Full side cladding and storage

Images may show optional equipment.

¹ Available on Crew Van Mid and Crew Van Uplevel.



1.–2. LOADS OF LOAD SPACE. There's instant access to underseat storage in the passenger section¹, plus up to 4,0 m³ behind the bulkhead.



CREW VAN BASE.

THE FOLLOWING FEATURES COME STANDARD:

- // Comfortable second-row bench with three separate seats
- // Bright but glare-free dome-style ceiling lamp
- // Half-height trim for a more pleasant ride

CREW VAN MID.

ALL THE FEATURES OF THE BASE, PLUS:

- // Three-seater second-row bench with armrests
- // Maximum child safety thanks to ISOFIX mounting points
- // Easily accessible underseat storage
- // Practical bench-mounted pocket

CREW VAN UPLEVEL.

ALL THE FEATURES OF THE MID, PLUS:

- // Individually adjustable second-row seats with armrests
- // Bench-mounted 12-V socket for portable devices
- // Step lamp for added visibility
- // Individual LED lights for second-row passengers
- // Stylish fixed sunblinds for second-row passengers
- // Full side cladding with versatile storage

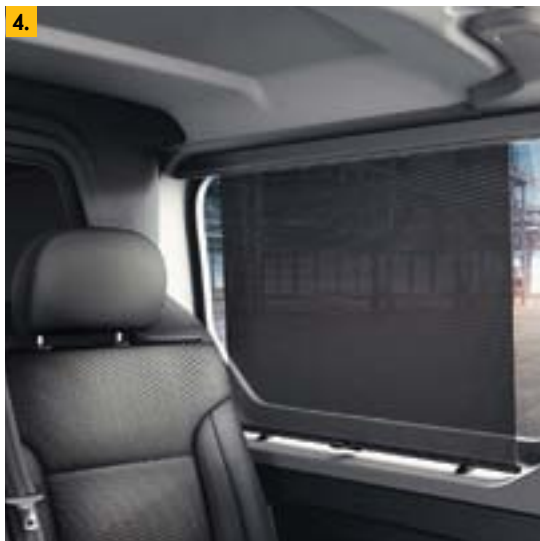
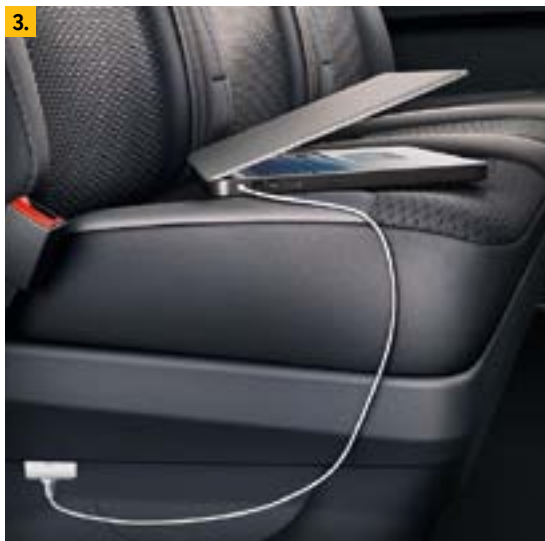

2.-3. MULTIFUNCTIONAL SECOND-ROW BENCH. Uplevel owners can offer passengers a 12-V power socket, side pocket and step lamp.

4. SIDE WINDOW WITH SUNBLIND. Integrated within the window frame for extra strength.



COMBI.

The versatile Vivaro for anyone with up to nine people to carry. VIP hotel shuttle meets sports team transport.

COMBI STANDARDS INCLUDE

- // High levels of comfort and workmanship
- // Comfortable seating for up to nine people
- // Front passenger seat bench
- // 3rd-row bench seat folds and tumbles for storage
- // Three-point safety belts for all seats
- // Two ISOFIX points for maximum child safety
- // Start/Stop System
- // Tyre Pressure Monitoring System
- // Hard-wearing rubber floor
- // Rear swing doors

For more information, turn the page.

Images may show optional equipment.



TILTABLE 60/40 SPLIT SECOND-ROW BENCH. Give your back seat passengers a clear and comfortable path between their seats and the side door.

COMBI TRIM LEVELS.

You couldn't ask for finer seating in a versatile working van.

COMBI VAN CHOICES

- // Two wheelbases cater different business needs
- // Complete exterior in body colour enhances design
- // Sliding rear windows
- // Single co-driver seat
- // Rear seat armrests
- // Air conditioning
- // Additional rear air conditioning
- // Additional rear heating
- // Tailgate with wash/wipe window

Images may show optional equipment.

¹Standard with Combi Edition plus Cosmo Pack. Optional for Combi Edition and Combi Edition plus Elegance Pack. ²Standard with Combi Edition plus Elegance Pack and Combi Edition plus Cosmo Pack.

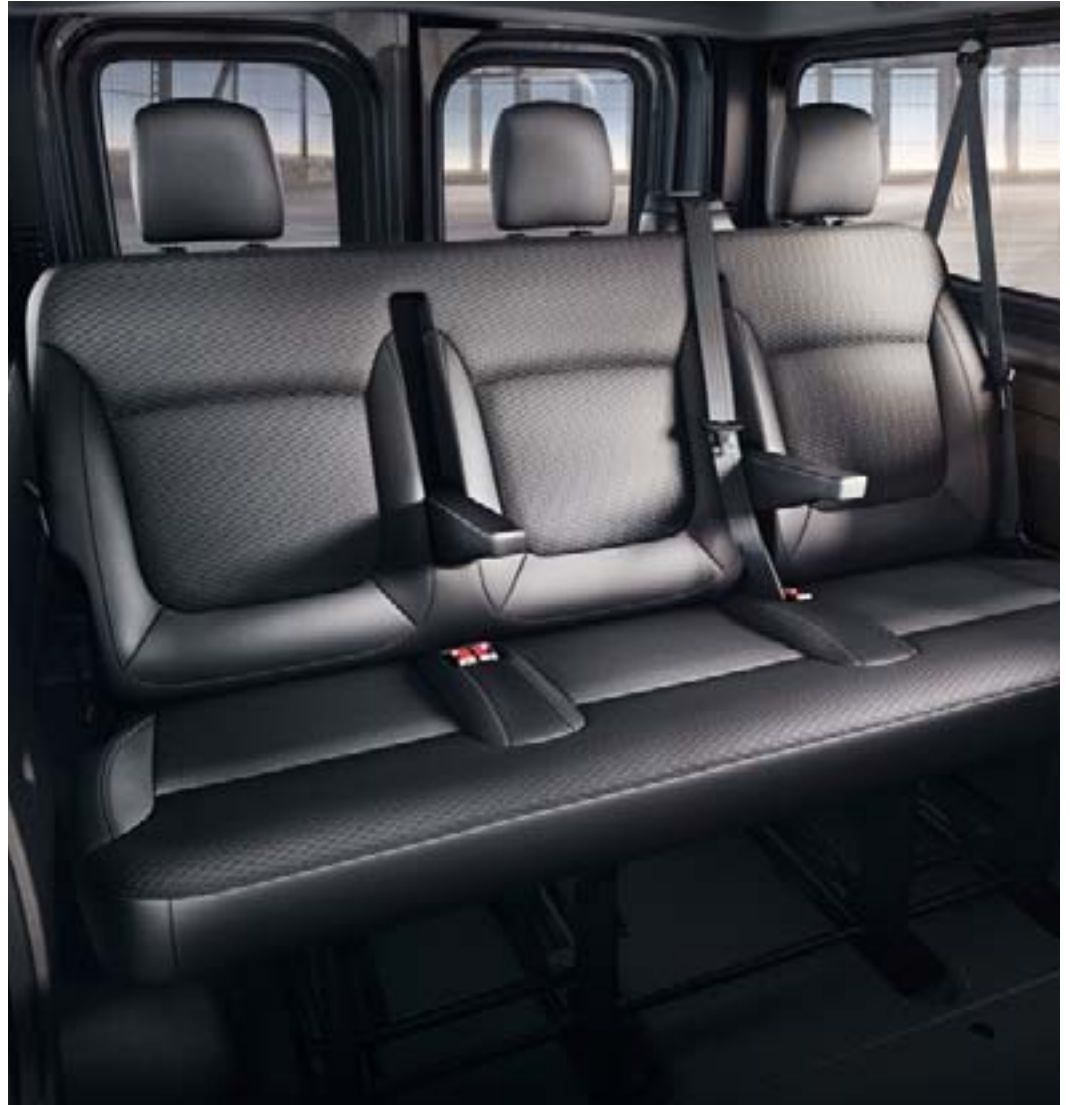

COMBI EDITION.

THE FOLLOWING FEATURES COME STANDARD:

- // 16" steel wheels with smart centre cap
- // Daytime Running Lights (halogen)
- // Stylish Tricess Blue trim fabric
- // Matching dashboard in Denim Blue
- // R16 radio with Bluetooth® and USB input
- // Electric windows and heated side mirrors
- // Front bench seats two passengers in comfort
- // Second- and third-row benches seat up to six
- // Remote central door locking
- // Driver and front passenger airbags
- // Rear swing doors



SECOND- AND THIRD-ROW BENCHES WITH ARMRESTS¹.
Easy to remove for more load space.

COMBI EDITION PLUS ELEGANCE PACK.

ALL THE FEATURES OF THE COMBI EDITION, PLUS:

- // 16" steel wheels protected by full cover
- // Cutting-edge Daytime Running Lights (LED)
- // Elegant Connect Black trim fabric
- // Dashboard in sleek Carbon Black
- // Armrests for extra comfort on both rear benches
- // Front fog lamps enhance safety and style
- // Leather steering wheel with cruise control
- // Front and rear outer bumpers in body colour



16" WHEELS². 17" alloys are available as an option (p. XX).

COMBI EDITION PLUS COSMO PACK.

ALL THE FEATURES OF THE COMBI EDITION PLUS ELEGANCE PACK, PLUS:

- // 17" alloy wheels
- // Remote selective door locking
- // CD18 CD radio with Bluetooth® and USB input
- // Cornering fog lamps maximize visibility
- // Automatic windscreen wipers and lights
- // Air conditioning front and rear
- // Windows open in side door and in panel opposite
- // Rear tailgate replaces swing doors



LED DAYTIME RUNNING LIGHTS². LED lights get you noticed and look smarter, by day or by night.

GROWTH POTENTIAL.

The Combi is the most versatile Vivaro of all. The Crew Van is by definition a multi-talented multitasker.

// Vary the seat/load space split in the Combi for up to nine people

// Remove second- and/or third-row benches without any tools

// Fold down third-row backrests for more versatility



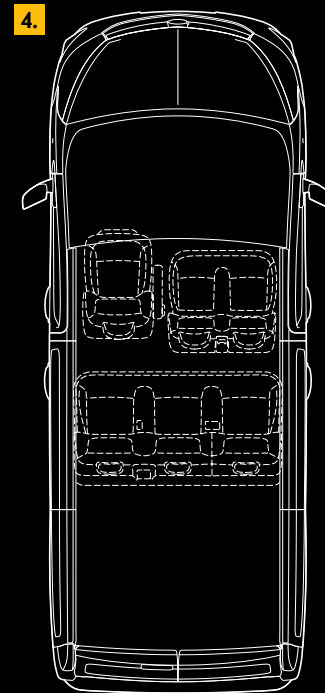
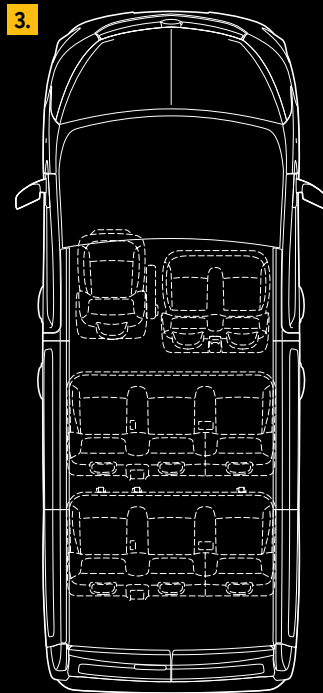
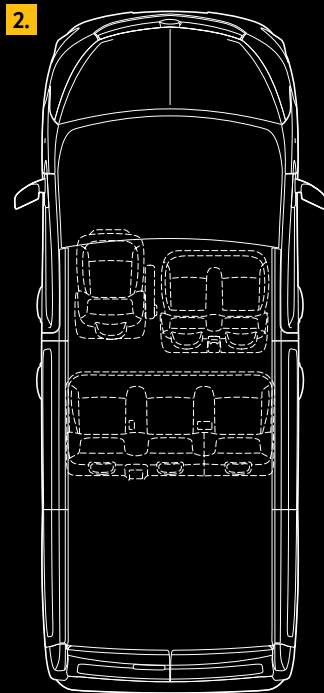
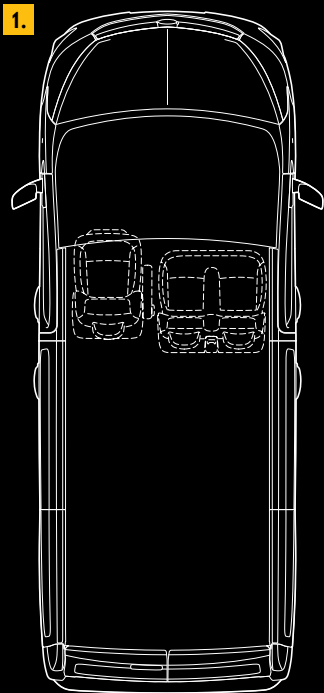

1. **THREE-SEATER COMBI.** Three up front, 5,2 m³ or 6,0 m³ of load space (depending on wheelbase).

2. **SIX-SEATER COMBI.** 3,2 m³ or 4,0 m³ load space behind the removable second-row bench (depending on wheelbase).

3. **NINE-SEATER COMBI.** Three rows of three, 1,8 m³ load space with long wheelbase. For more space, fold down the rear row or remove both benches.

4. **SIX-SEATER CREW VAN.** A full bulkhead separates passengers from a load compartment with space for a euro-pallet.

1.



WELCOME TO FIRST CLASS.

This customized Vivaro is an outstanding collaboration – for good reason. Irmischer has a reputation for excellent individualization and Vivaro has a reputation for excellent vans.

THE IRMSCHER EFFECT:

- // Leather surfaces feature hand-stitched seams
- // Leather-covered padding upgrades your armrests
- // High-quality velours floor mats look luxurious
- // Wheel house and D-pillar trims enhance the looks of the interior
- // Upgrade the exterior with optional exclusive 17" alloys

Powered by

irmscher

The Tourer Pack is an accessory package supplied by Irmischer Automobilbau GmbH & Co. KG. This package is only available for specific Opel Vivaro variants and is warranted by Irmischer Automobilbau GmbH & Co. KG. Adam Opel AG does not give any warranty for any of the package parts and is not liable for their quality. Spare parts for the Tourer Pack can be obtained from Irmischer Automobilbau GmbH & Co. KG.

2.



3.



1. SECOND ROW GOES FIRST CLASS. Welcome rear-seat passengers with stitched seams, exclusive floor mats and the scent of leather

2. STITCHED LEATHER DASHBOARD CLADDING. Soft leather looks premium and feels even better.

3. STITCHED LEATHER ARMREST PADDING. Top-of-the-line surfaces put you and your passengers at ease.

4. VELOURS FLOOR MATS. Everyone sees the quality the second you open the door.

5. 17" ALLOY WHEELS. Five spokes, one logo. Optional Irscher-branded alloys speak volumes about the pedigree of your van.

4.



5.







PLATFORM CAB.

Ultimate conversion potential, outstanding style and impressive flexibility. The Vivaro Platform Cab transforms perfectly, whatever your needs.

SPECIFICS

- // Max. gross vehicle weight of 2.990 kg
- // Versatile long wheelbase
- // Comprehensive comfort and safety equipment
- // Optimized for specialist bodywork
- // Optional engine-driven power take-off

Images may show optional equipment.

YOUR OUT-OF-OFFICE OFFICE.

The Vivaro is an ergonomic, well-organized office. There's a place for everything, and everything has its place.

YOUR OPEL MOBILE OFFICE INCLUDES

- // Maximum driver convenience and comfort
- // Steering-wheel mounted radio controls
- // Category-first office bench seat¹
- // Bluetooth® for hands-free phone and audio streaming
- // Large glove box for A4 documents
- // Easy-access dashtop shelf
- // Three cupholders
- // Optional dash-mounted smartphone dock²
- // Optional dash-mounted tablet dock³

Images may show optional equipment.

¹Office bench seat standard with Panel Van Sportive, optional with Crew Van Edition plus Cosmo Pack. Storage compartment available on Panel Van Edition only. ²Available as an option for all Opel supplied infotainment devices.

³Compatible with R16 BT USB radio.





1. USB PORT. Hook up via USB for messages and more.

2. BUILT-IN, REMOVABLE CLIPBOARD. Part of the office bench seat. It's practical, flexible and removable.

3. OFFICE BENCH SEAT. Seat three people up front, or the driver and one passenger separated by easy-reach storage and the convenient flip-up table for a laptop or upright tablet as shown on page XX. It includes the removable clipboard.

SMARTER SYSTEMS. SAFER SURROUNDINGS.

The Vivaro is one of the most secure, best-connected vans on the market.

STANDARD SAFETY TECHNOLOGIES

- // ESP[®] with Electronic Brake-force Distribution and ABS
- // Hill Start Assist and Traction Control
- // Emergency Brake Assist
- // Adaptive Load Control
- // Active Rollover Protection
- // Trailer Sway Assist in combination with optional trailer hitch

STATE-OF-THE-ART INFOTAINMENT OPTIONS

All Opel audio and navigation systems include:

- // Bluetooth[®] and USB for smartphones and MP3 players
- // Steering wheel-mounted remote controls



¹Available from spring 2016. ²Standard on Panel Van Edition and Crew Van Base. Optional on Panel Van Essentia. ³Function smartphone-dependent.



1.



2.



4.



3.



5.

1. NAVI 80 INTELLILINK SAT NAV¹. The intuitive, top-of-the-range system with 3D viewing, [advanced Voice Control](#) and [TomTom LIVE services for real-time traffic information](#). The 7-inch display is also screen for the optional rear-view camera.

2. R16 BT USB BLUETOOTH[®] RADIO². With MP3 and WMA playback, plus optional digital radio. For CD playback, upgrade to the CD18 BT USB.

3. TABLET DOCKING STATION. Compatible with the R16 BT USB Bluetooth[®] radio, allows tablets between 4,8 inches and 10,6 inches to be mounted in perfect sight and reach.

4. NAVI 50 SAT NAV. Excellent-value optional navigation system with a 7-inch (17,8-cm) touch screen and [map coverage for Western or Eastern Europe with 2D and bird view](#). [Free 'aha' app on connected smartphone allows access to Internet radio and social media via the touch screen³](#). Digital radio optional.

5. REAR-VIEW CAMERA IN INTERIOR MIRROR. Projected guidelines give good orientation when backing up.



FLEXCARGO® FLEXIBILITY. A practical hatch in the FlexCargo® bulkhead lets you securely store cargo up to fully 4,15 metres long. Open the hatch and push it through under the passenger seat and up level with the glove box.

OPTIONS.

Factory-fitted options customize your Vivaro for specialist tasks.

// Choose from a broad selection of options

// Adapt your van to your specific business needs



1. SLIDING DOOR, DRIVER SIDE. Ideal for confined locations and separate workspace compartments.

2. FLOORING & SIDE PROTECTION. Anti-slip, resin-coated 9-mm plywood flooring offers grip and protection for cargo and staff. Humidity-resistant, easy-clean, plastic-coated 4-mm plywood side panels safeguard both your load and your van.

3. REAR HEATING SYSTEM. A heat exchanger and fan keep rear seat passengers warm in winter. An optional additional boiler¹ heats the vehicle even quicker.

4. CONTROLS IN THE BACK. Additional heating and air-conditioning controls give your Combi passengers the VIP treatment.

ACCESSORIES.

When business parameters change, your van adapts with the times.

- // A host of accessories available post-purchase
- // Opel accessories are tailor-made for the Vivaro
- // Fit and remove as need be



Search our shelves. Go to www.opel-accessories.com for more options and accessories.





1. **ROOF CARRIER LADDER.** A must for safely loading and unloading the roof. This robust tubular steel ladder is available for the tailgate or swing doors.

2. **BASE CARRIER.** The sure-fire way to fasten long or awkward loads to the roof. The base carrier works best with a roof rack, ladder clamp, loading bars and load stop.

3. **INTERIOR ROOF RACK.** Using the space beneath the roof frees up space on the load floor. The rack loads up to 12 kg and comes with a load stop.

4. **TOWING HITCHES.** From the detachable tow ball to the flange tow bar and the heavy-duty pin and ball-type.

5. **WOODEN PROTECTION.** Tailored panels protect the side walls and wheel arches. The wooden floor comes in different strength and is available with anti-slip coating.



AFFORDABILITY IN ACTION.

- // Match a Vivaro variant to your specifications
- // Contact your Opel dealership for more details

Every Vivaro is a model of efficiency, but other parameters vary from van to van.

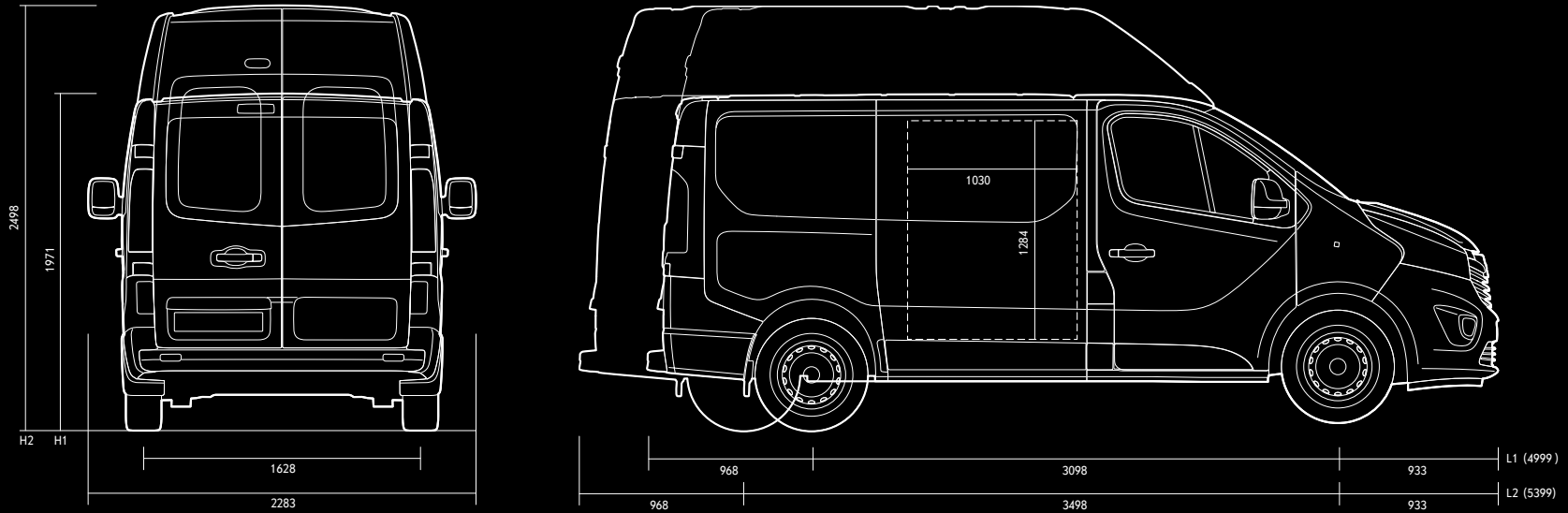

All dimensions in mm.

VARIANTS

LENGTHS AND HEIGHTS		PANEL VAN	CREW VAN	COMBI
L1	H1	•	•	•
	H2	•	–	–
L2	H1	•	•	•
	H2	•	–	–

• = available – = not available

CARGO CAPACITIES

OPEL VIVARO body versions	WEIGHT CLASS (in kg)	GROSS VEHICLE WEIGHT (in kg)	NUMBER OF SEATS	MAX. PAYLOAD (in kg)	MAX. ROOF LOAD (in kg)	MAX. LOAD VOLUME (in m ³)	MAX. LOAD COMPARTMENT FLOOR LENGTH (in mm)	LOAD FLOOR WIDTH MAX./ BETWEEN WHEEL ARCHES (in mm)	MAX. LOAD COMPARTMENT HEIGHT (in mm)	TURNING CIR- CLE (KERB TO KERB/ WALL TO WALL) (in m)
Panel Van										
L1H1	2.700	2.740–2.760	2–3	1.004	200	5,2	2.537	1.662/1.268	1.387	11,84/12,4
L1H1	2.900	2.900–2.920	2–3	1.164	200	5,2	2.537	1.662/1.268	1.387	11,84/12,4
L1H2	2.900	2.890–2.920	2–3	1.099	150	7,2	2.537	1.662/1.268	1.897	11,84/12,4
L2H1	2.900	2.960–3.010	2–3	1.199	200	6,0	2.937	1.662/1.268	1.387	13,17/13,73
L2H2	2.900	2.980–3.030	2–3	1.151	150	8,6	2.937	1.662/1.268	1.897	13,17/13,73
Crew Van										
L1H1	2.700	2.780–2.800	5–6	975	200	3,2	2.000	1.662/1.268	1.387	11,84/12,4
L1H1	2.900	2.810–2.830	5–6	1.005	200	3,2	2.000	1.662/1.268	1.387	11,84/12,4
L2H1	2.900	2.920–2.940	5–6	1.060	200	4,0	2.400	1.662/1.268	1.387	13,17/13,73
Combi										
							6-seater/9-seater	6-seater/9-seater		
L1H1	2.700	2.740–2.900	2–9	924	200	3,2/1,0	1.679/765	1.662/1.268	1.387	11,84/12,4
L2H1	2.900	2.845–3.010	2–9	1.034	200	4,0/1,8	2.079/1.165	1.662/1.268	1.387	13,17/13,73

Minimum vehicle weight according to type approval, with minimum equipment according to type approval. Max. payload already takes the weight of the driver into account.

ENGINES AND TRANSMISSIONS.

High-tech diesel engines deliver excellent performance, fuel consumption and emissions. Advanced technologies like BiTurbo reduce operating costs, irrespective of payload.

ENGINES AND TRANSMISSIONS

Engines	1.6 CDTI 90	1.6 CDTI 95	1.6 CDTI 115	1.6 BITURBO 120	1.6 BITURBO 125	1.6 BITURBO 140	1.6 BITURBO 145
Power in kW (hp)/at rpm	66 (90)/3.500	70 (95)/to follow	85 (115)/3.500	88 (120)/3.500	92 (125)/to follow	103 (140)/3.500	107 (145)/to follow
Torque in Nm/at rpm	260/1.500	to follow/to follow	300/1.750	320/1.500	to follow/to follow	340/1.750	to follow/to follow
Transmission	MT-6	MT-6	MT-6	MT-6	MT-6	MT-6	MT-6
Emission standard	Euro 5	Euro 6	Euro 5	Euro 5	Euro 6	Euro 5	Euro 6

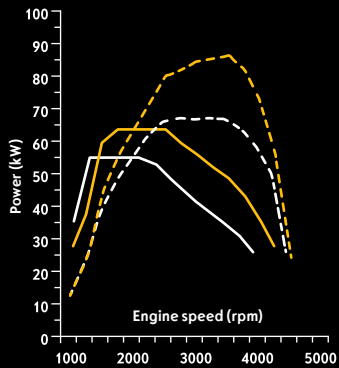

1.6 CDTI 115
 // 300 Nm at 1.750 rpm
 // 85 kW (115 hp) at 3.500 rpm

1.6 CDTI 90

Torque

Power

1.6 CDTI 115

Torque

Power

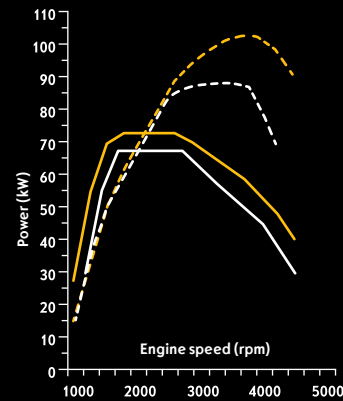

1.6 BITURBO
 // More power and torque per cc
 // Constant power development

1.6 BITURBO 120

Torque

Power

1.6 BITURBO 140

Torque

Power

BITURBO ENGINES

- // Twin intercooler for clean, efficient combustion
- // Lag-free acceleration at any speed, with any payload
- // Available with Start/Stop System, standard on Combi

QUIET, CLEAN AND EFFICIENT DIESEL ENGINES

- // Optimized thermal and oil pump management
- // Maintenance-free chain drive and particle filter
- // Multi-point fuel injection for low emissions and high performance
- // Service intervals up to 2 years/40.000 km

CONSUMPTION AND EMISSIONS

Engines	1.6 CDTI 90 ²	1.6 CDTI 90 ECOFLEX ² with Start/Stop System	1.6 CDTI 95 ECOFLEX ³ with Start/Stop System	1.6 CDTI 115 ²	1.6 BITURBO 120 ECOFLEX ² with Start/Stop System	1.6 BITURBO 125 ECOFLEX ³ with Start/Stop System	1.6 BITURBO 140 ²	1.6 BITURBO 140 ECOFLEX ² with Start/Stop System	1.6 BITURBO 145 ECOFLEX ³ with Start/Stop System
---------	--------------------------	--	--	---------------------------	--	--	---------------------------------	--	--

Table shows scale of consumption and emission data depending on variants and tyres. Please contact your Opel dealer or refer to price list for specific information.

Fuel	Diesel	Diesel	Diesel	Diesel	Diesel	Diesel	Diesel	Diesel	Diesel
Fuel consumption in l/100 km¹									
Urban	Combi (M1)		to follow			to follow			to follow
	Panel Van H1/H2 (N1)	7,8	7,1	7,8	6,6/8,1	7,6/8,7	7,0/8,1		
	Crew Van (N1)	7,9–7,8	7,2–7,1	7,9–7,8	6,8–6,6	7,8–7,6	7,2–7,0		
Extra-urban	Combi (M1)		to follow			to follow			to follow
	Panel Van H1/H2 (N1)	5,7	5,5	5,7	5,5/6,4	5,8/6,7	5,6/6,4		
	Crew Van (N1)	5,9–5,7	5,7–5,5	5,9–5,7	5,7–5,5	6,0–5,8	5,7–5,6		
Combined	Combi (M1)		to follow			to follow			to follow
	Panel Van H1/H2 (N1)	6,5	6,1	6,5	5,9/7,0	6,5/7,4	6,1/7,0		
	Crew Van (N1)	6,6–6,5	6,2–6,1	6,6–6,5	6,1–5,9	6,6–6,5	6,2–6,1		
CO₂ emission in g/km¹									
Combined	Combi (M1)		to follow			to follow			to follow
	Panel Van H1/H2 (N1)	170	160	170	155/185	170/195	160/185		
	Crew Van (N1)	174–170	164–160	174–170	160–155	174–170	164–160		

MT-6 = 6-speed manual transmission M1 = EU vehicle classification for vehicles for passenger carriage only. N1 = EU vehicle classification for light commercial vehicles with a gross vehicle weight of up to 3,5 t

All information was accurate and up to date at the time of going to print. The company reserves the right to alter engine specifications at any time, which may influence the content of the shown data. Please consult your Opel dealer for the latest information. M1: all figures quoted relate to the EU base model with standard equipment. Fuel consumption data and CO₂ emission data are determined according to regulations R (EC) No. 715/2007 and R (EC) No. 692/2008 (in the versions respectively applicable), taking into consideration the vehicle weight in running order, as specified by the regulations. Additional equipment and factory-fitted options may lead to slightly higher results than the stated consumption and CO₂ figures. The figures for fuel consumption and CO₂ emissions do not relate to a specific vehicle and are not part of an offer. They are provided only for the purpose of comparison between different vehicles but may differ from the actual fuel consumption achieved in real-world driving conditions which are greatly influenced by driving style and operating conditions. Additional equipment and factory-fitted options may increase the weight of the vehicle when empty and in some cases the permissible axle weights as well as the permissible total weight of the vehicle and reduce the permissible towing weights. This may lead to a reduction in top speed and increased acceleration time. Driving performance figures assume a 75 kg driver plus a 125 kg load. N1: fuel consumption data and CO₂ emission data are determined according to regulations R (EC) No. 715/2007 and R (EC) No. 692/2008 (in the versions respectively applicable). The figures for fuel consumption and CO₂ emissions do not relate to a specific vehicle and are not part of an offer. They are provided only for the purpose of comparison between different vehicles but may differ from the actual fuel consumption achieved in real-world driving conditions which are greatly influenced by driving style and operating conditions. Additional equipment and factory-fitted options may increase the kerb weight of the vehicle and impact the payload. This may lead to a reduction in top speed and increased acceleration time. Driving performance figures assume a 75 kg driver plus a 125 kg load.

¹In acc. with regulations R (EC) No. 715/2007 and R (EC) No. 692/2008 (in the versions respectively applicable). ²Not available on Combi. ³Only available on Combi.

BIG STEPS. SMALL FOOTPRINT.

Opel is committed to reducing the impact of vehicles on the environment.

ECOFLEX SUSTAINABLE TECHNOLOGIES

- // Reduce fuel consumption to cut operating costs
- // Achieve high mileage with a low carbon footprint
- // BiTurbo models include Eco Mode for maximum efficiency

ECO MODE

- // Optimizes key system settings
- // Prompts driver to drive more efficiently
- // Summarizes consumption after each trip

START/STOP

- // Saves fuel and emissions
- // Cuts/restarts the engine when appropriate

SMART CHARGING

- // Reuses energy recovered from braking
- // Reduces fuel consumption

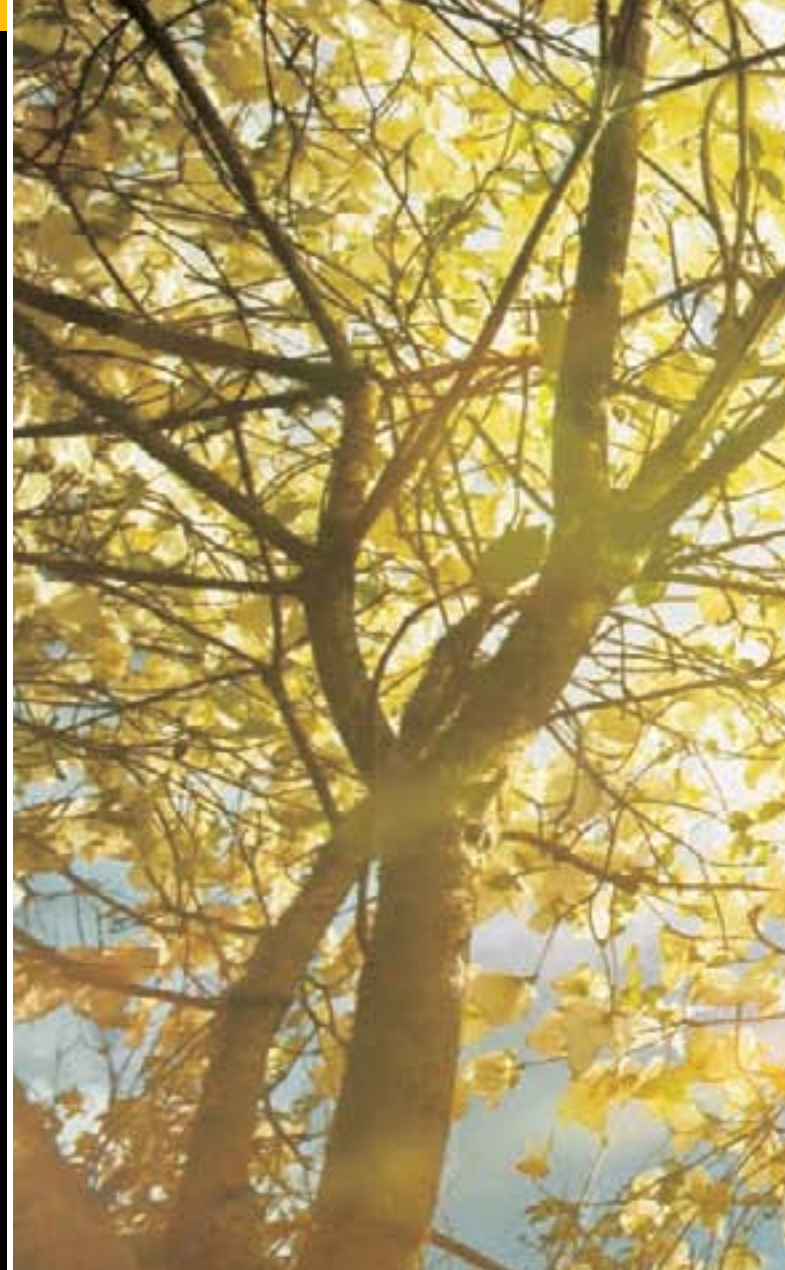
The logo for Opel's ecoFLEX technologies. The word "eco" is written in a lowercase, rounded, metallic font with a 3D effect. The word "FLEX" is written in a bold, uppercase, sans-serif font, also with a metallic 3D effect. The two words are joined together.



TRIMS AND SURFACES.

A smart van interior says a lot about your business.

- // Impress passengers with attractive combinations
- // Project an excellent business image
- // Rely on hard-wearing materials

TRICISS BLUE/DINO TRIM



Dino bolster fabric in Jet Black.



Triciss Blue seat insert fabric in Denim Blue.

CONNECT BLACK EMBOSSED/JEANNO TRIM



Jeanno bolster fabric in Jet Black.



Connect Black Embossed seat insert fabric in Jet Black.

PAINTS AND WHEELS.

Stylish, hard-working vans deserve paints and wheels to match.

- // Stylish colours and wheels cement your company image
- // Colours are best viewed at your local dealership
- // Wheels are variant-specific

SOLID



Casablanca White



Magma Red



Iron Grey



Spring Green

METALLIC



Panorama Blue



Midnight Black



Cassiopeia Silver



Copper Brown

SOLID



Ink Blue



16" steel wheel with centre cap, 6J x 15", tyres 205/65 R 16 (P91).



16" steel wheel with full-size 10-spoke cover, 6J x 16", tyres 215/65 R 16 (QP9)¹.



17" alloy wheel, 6J x 17", tyres 215/65 R 17 (RSB)².

METALLIC



Jasper Brown



Platinum Silver

WHEELS

Dimension	205/65 R16	215/65 R16	215/60 R17
Tyre Fuel Efficiency Rating	E-C	C	C
Tyre Wet Grip Rating	E-B	B	B
Tyre Noise Rating (dB)	72-71	70	70
Sound Class			

¹Not available for Panel Van Sportive Trim Levels. ²Available as an option for all Trim Levels.





TAKING CARE OF BUSINESS.

FlexCare is the all-encompassing Vivaro service programme. It's integrated and customizable to new owners' needs.

FLEXCARE INCLUDES

- // Guaranteed mobility for peace of mind
 - // Free roadside assistance
 - // Class-leading low ownership costs
 - // Individually tailored cover
 - // Full service history for best resale value
 - // Warranty extension to three, four or five years
 - // Five-year annual service plan
 - // Balance running and service costs over lifetime of van
- Ask your local Opel dealership for details.

NOTE TO COUNTRIES:

Please check whether your country offers the app and choose the appropriate copy intro.

myOpel.

Unser exklusives Portal für alle Opel Fahrer.

Bequem, individuell, übersichtlich und immer aktuell: myOpel bringt die Vorteile des Opel Original Service direkt zu Ihnen auf Ihr Handy, Tablet oder den PC – ganz egal, ob es um Ihre nächste Inspektion, die neuesten Angebote oder eine Online-Serviceanfrage geht.

Stimmen Sie zu jeder Zeit und von jedem Ort aus online Ihre Termine mit uns ab und bekommen Sie automatische Erinnerungen per E-Mail.

Registrieren Sie sich jetzt und verpassen Sie nie wieder ein perfekt auf Sie und Ihren Opel abgestimmtes Angebot.

Funktionen rund um Ihren Opel stehen für Sie bereit – kostenlos und wann immer Sie wollen, zum Beispiel:

- // Online-Serviceanfragen
- // Persönliche Angebote und Service-Checks
- // Handbücher sowie Tipps und Tricks
- // Erinnerungen an Servicetermine
- // Virtuelle Garage für bis zu vier Fahrzeuge

Und mit unserer kostenlosen myOpel App für iPhones und Android-Smartphones haben Sie den Opel Service auch unterwegs immer dabei.

Copy for countries that **DO** offer the app.

Copy for countries that **DO NOT** offer the app.

NOTE TO COUNTRIES:
If your country does not offer the full service history, please delete this bullet.

NOTE TO COUNTRIES:
If your country does not offer the app, please delete bullet number 3.





OPEL FOR LIFE.

Opel keeps you on the road for the lowest cost possible. 24/7, 365 days a year.

OUR SERVICE OFFERS

- // Comprehensive after-sales programmes
- // Fast-access Opel4Business support
- // Customizable FlexCare package for business

OPEL4BUSINESS

- // All-in-one package with 24/7 priority status
- // One contact number plus IT support
- // Widespread network of business centres
- // Ensures best Cost Of Ownership

STANDARD OPEL WARRANTY

- // 24 months, no mileage limit, 12-year anti-perforation warranty
- // 6.000 Opel service points, 2.000 commercial vehicle service centres
- // Includes Opel Roadside Assistance for first 12 months in 40 countries
- // Opel Original spare parts guaranteed

INNOVATIONS THAT MEAN BUSINESS.

Opel innovations make our vans more efficient, safer, more versatile and more productive. They are more comfortable to drive, work and ride in throughout the year.



LED DAYTIME RUNNING LIGHTS. LED lights deliver better visibility and make your van more visible to other drivers. These stylish headlamps are always on. For more information, turn to page [XX](#).



BLIND ANGLE MIRROR. Mounted in the front passenger sunblind, this additional rear-view mirror can be tilted to give drivers a better view of what's behind the van. For more information, turn to page [XX](#).



REAR VIEW CAMERA. In combination with the park sensor, this dash-mounted screen helps you avoid low obstacles when reversing. For more information, turn to page [XX](#).



ELECTRONIC CLIMATE CONTROL. Set a different temperature for different parts of the Vivaro to keep driver and passengers comfortable in any weather. For more information, turn to page [XX](#).



BLUETOOTH® AND USB. Seamless connectivity comes standard with every Opel supplied radio or infotainment system in every Vivaro. Ideal for accessing portable digital devices. For more information, turn to page [XX](#).



BITURBO TECHNOLOGY. Opel BiTurbo engines use a sequential double turbo system to eliminate turbo lag and deliver smooth acceleration even at low revs. For more information, turn to page [XX](#).



MOBILE OFFICE. A combination of practical features such as the front of-ice bench seat that converts into a removable clipboard, hidden storage and stable desk for a laptop. For more information, turn to page [XX](#).



FLEXCARGO® BULKHEAD. This clever bulkhead has a load-through hatch under the front bench that effectively lengthens the load space on the passenger side to 4,15 metres. For more information, turn to page [XX](#).



www.opel.com

Some illustrations in this brochure contain special equipment not included in standard delivery. The information contained in this brochure was accurate at the time of going to press. We reserve the right to make changes in design and equipment. The colours printed in the brochure only approximate actual colours. Illustrated optional equipment is available at extra charge. Availability, technical features and equipment provided on our vehicles can vary outside of the Federal Republic of Germany. Information about Design for Recycling, take-back locations for End of Life Vehicles (ELVs) and the recycling of ELVs can be found on the Internet page www.opel.com. For precise information on the equipment provided on our vehicles, please contact your local Opel partner.

PARTNER WITH A PERFORMER.

The Vivaro impresses clients and colleagues alike. Intelligent, convenient and easy to use, it's a well-equipped workspace and a major motivator.

// COMFORTABLE AND PRACTICAL

// Six-way ADJUSTABLE DRIVER'S SEAT with armrest and lumbar support

// Office bench with desk, REMOVABLE CLIPBOARD and in-seat storage

// **USB** and **BLUETOOTH®** for the ultimate mobile office

// **DASHBOARD MOUNTS** for smartphones and tablets

For more information, turn to page **XX**.

Image may show optional equipment not available from Opel.





Spread page assigned for optional addition to maintain printable total no. of pages.

1.



WELCOME TO FIRST CLASS.

This customized Vivaro is an outstanding collaboration – for good reason. Irmischer has a reputation for excellent individualization and Vivaro has a reputation for excellent vans.

THE IRMSCHER EFFECT:

- // Leather surfaces feature hand-stitched seams
- // Leather-covered padding upgrades your armrests
- // High-quality velours floor mats look luxurious
- // Wheel house and D-pillar trims enhance the looks of the interior
- // Upgrade the exterior with optional exclusive 17" alloys

Powered by

irmscher

The Tourer Pack is an accessory package supplied by Irmischer Automobilbau GmbH & Co. KG. This package is only available for specific Opel Vivaro variants and is warranted by Irmischer Automobilbau GmbH & Co. KG. Adam Opel AG does not give any warranty for any of the package parts and is not liable for their quality. Spare parts for the Tourer Pack can be obtained from Irmischer Automobilbau GmbH & Co. KG.

2.



3.



4.



5.



1. SECOND ROW GOES FIRST CLASS. Welcome rear-seat passengers with stitched seams, exclusive floor mats and the scent of leather

2. STITCHED LEATHER GEAR STICK GAITER AND KNOB COVER. The material under your hand literally gives your Vivaro a touch of class.

3. STITCHED LEATHER ARMREST PADDING. Top-of-the-line surfaces put you and your passengers at ease.

4. VELOURS FLOOR MATS. Everyone sees the quality the second you open the door.

5. STITCHED LEATHER DASHBOARD CLADDING. Soft leather looks premium and feels even better.

AFFORDABILITY IN ACTION.

- // Match a Vivaro variant to your specifications
- // Contact your Opel dealership for more details

Every Vivaro is a model of efficiency, but other parameters vary from van to van.

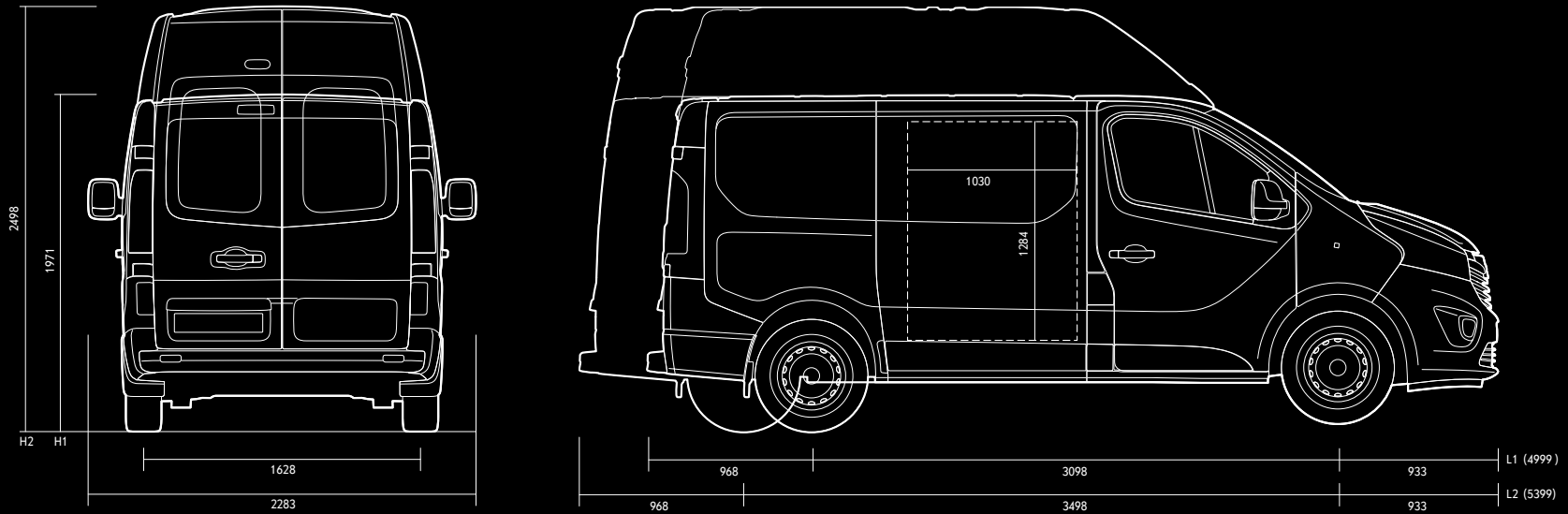

All dimensions in mm.

VARIANTS

LENGTHS AND HEIGHTS		PANEL VAN	CREW VAN	COMBI	PLATFORM CAB
L1	H1	•	•	•	–
	H2	•	–	–	–
L2	H1	•	•	•	•
	H2	•	–	–	–

• = available – = not available

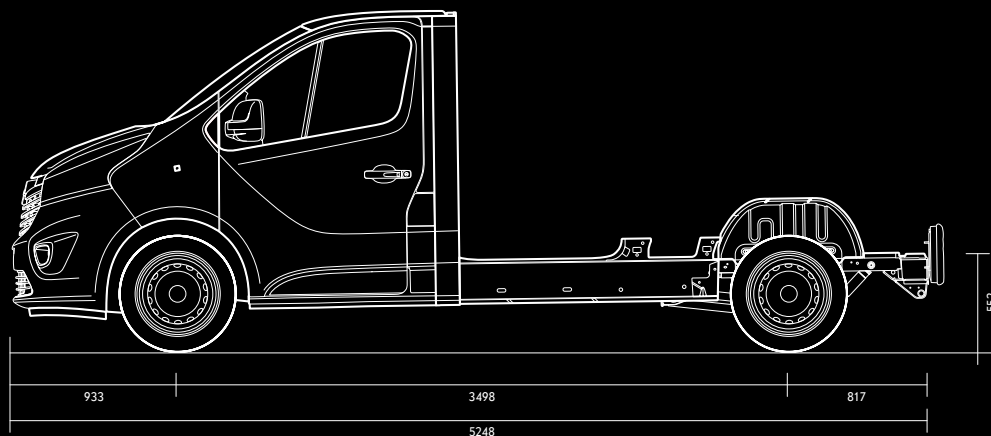
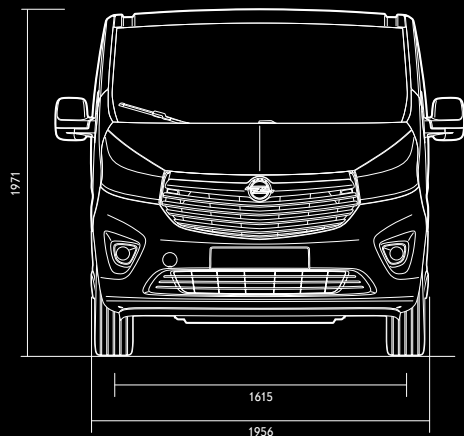

CARGO CAPACITIES

Opel Vivaro body versions	Weight Class (in kg)	Gross Vehicle Weight (in kg)	Number of Seats	Max. Payload (in kg)	Max. Roof Load (in kg)	Max. Load Volume (in m ³)	Max. Load Compartment Floor Length (in mm)	Load Floor Width Max./ Between Wheel Arches (in mm)	Max. Load Compartment Height (in mm)	Turning Cir- cle (Kerb to Kerb/ Wall to Wall) (in m)
Panel Van										
L1H1	2.700	2.740–2.760	2–3	1.004	200	5,2	2.537	1.662/1.268	1.387	11,84/12,4
L1H1	2.900	2.900–2.920	2–3	1.164	200	5,2	2.537	1.662/1.268	1.387	11,84/12,4
L1H2	2.900	2.890–2.920	2–3	1.099	150	7,2	2.537	1.662/1.268	1.897	11,84/12,4
L2H1	2.900	2.960–3.010	2–3	1.199	200	6,0	2.937	1.662/1.268	1.387	13,17/13,73
L2H2	2.900	2.980–3.030	2–3	1.151	150	8,6	2.937	1.662/1.268	1.897	13,17/13,73
Crew Van										
L1H1	2.700	2.780–2.800	5–6	975	200	3,2	2.000	1.662/1.268	1.387	11,84/12,4
L1H1	2.900	2.810–2.830	5–6	1.005	200	3,2	2.000	1.662/1.268	1.387	11,84/12,4
L2H1	2.900	2.920–2.940	5–6	1.060	200	4,0	2.400	1.662/1.268	1.387	13,17/13,73
Combi										
						6-seater/9-seater	6-seater/9-seater			
L1H1	2.700	2.740–2.900	2–9	924	200	3,2/1,0	1.679/765	1.662/1.268	1.387	11,84/12,4
L2H1	2.900	2.845–3.010	2–9	1.034	200	4,0/1,8	2.079/1.165	1.662/1.268	1.387	13,17/13,73
Platform Cab										
L2H1	2.900	2.990	2–3	1.410	–	–	–	–	–	13,17/13,73

Minimum vehicle weight according to type approval, with minimum equipment according to type approval. Max. payload already takes the weight of the driver into account.