

The new Audi A4 Saloon and Avant
Pricing and Specification Guide
Valid from July 2008



A User's Guide

This guide has been designed to help you tailor and price your chosen A4 model quickly and logically. At the back of this guide, you will also find information on CO₂ emissions-based taxation and the other services offered by Audi, including Finance and Insurance. If you wish, you can also go to audi.co.uk and configure your A4 online.

Table of content

	Page Number
Introduction	
The new A4	4
Engines and quattro	6
Model details and prices	
Standard model	8
SE model	10
S line model	12
Transmission	14
Colour and upholstery	
Paint finishes	18
Upholstery options	20
Colour and trim guide	24
Inlays	26
Options	
Wheels, tyres and suspension	30
Audio and communication	32
Seats	34
Safety and security	35
Interior/Exterior equipment	36
Steering wheels	37
Audi exclusive	
Audi exclusive options	38
Technical details	
Technical data	44
Dimensions	48
Other information	50

The new A4

With its innovative technologies and modern, pioneering design, the new Audi A4 is set to completely redefine your driving experience. Sporty exterior styling and exceptional interior refinement ensure that it creates a long-lasting impression of style and sophistication, which is reinforced when you start to discover the exclusive features that lie beneath its sculpted bodywork.

The Audi drive select system provides agility and control, while retaining directional stability and precise steering in difficult, high-speed driving conditions. What's more, Audi drive select can be tuned by each individual, ensuring a drive that's perfectly customised for your needs. But that's not all. The climate controlled seats add even more comfort, while Audi side assist and Audi lane assist guarantee a safer, more satisfying journey.

In short, the new Audi A4 incorporates the ideal combination of cutting-edge design and advanced technologies, allowing it to deliver one of the most balanced, rewarding driving experiences in the industry. From its sporty appearance to its refined interior features, each aspect has been expertly developed to produce a remarkable vehicle that raises the benchmark for design and driving dynamics.





Engines

Petrol

All A4 petrol engines feature FSI® direct-injection – a unique Audi technology originally developed for the Le Mans 24-hour endurance race to deliver increased power and torque as well as enhanced fuel efficiency. The way it does this is, in theory, very simple. Precisely the right amount of fuel and air are injected directly into the combustion chambers, enabling the engine to 'breathe' more easily. At the same time, electronics monitor the engine load and adjust the injection process. The result – reduced heat-loss and increased output, with around a 15% reduction in fuel consumption and significantly lower exhaust emissions. Ideal for the buyer who wants a sporty, exhilarating drive without the drawbacks of excessive fuel costs or high CO₂ emissions.

Diesel

All diesel engines from Audi are known as TDI®. This impressive technology was originally pioneered by Audi in 1989, marking a departure from the noisy, fuel-thirsty diesel engines of the past. Like its FSI petrol counterpart, the TDI® diesel engine is designed for power, performance, low fuel consumption and reduced CO₂ emissions.

All A4 TDI® engines are based on the common rail system. Here, fuel is stored and kept at constant pressures of up to 1,600 bar, ready to feed a series of highly accurate piezo injectors, which control the rate and point of injection.

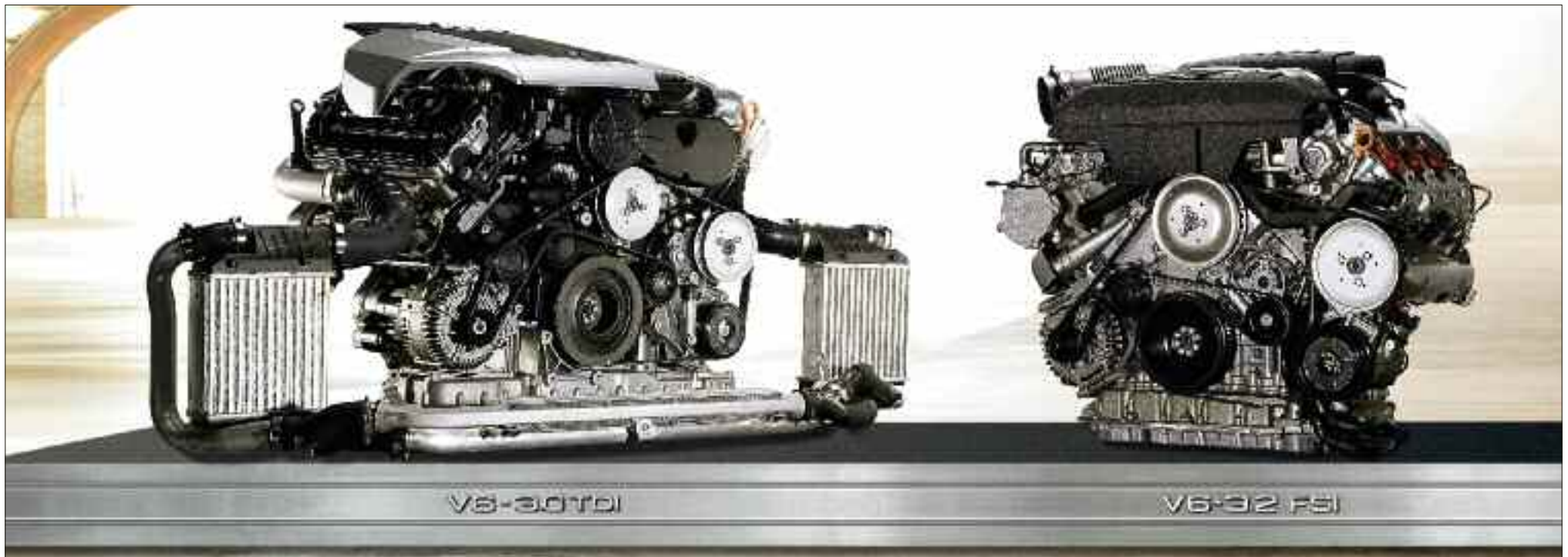

V6-3.0 TDI

V6-3.2 FSI

quattro®

Permanent four-wheel-drive

It's the technology that has given Audi the edge on the racetrack ever since it was first introduced over 25 years ago – a technology that delivers ultimate control whilst enhancing the sporty characteristics which make the A4 so thrilling to drive. It's called quattro® permanent four-wheel-drive. The principle is simple: in the same way that four brakes ensure better deceleration, four permanently-driven wheels deliver better acceleration and road-holding, pushing or pulling the car

as needed, for a driving experience that's both dynamic and safe. In the A4 asymmetric-dynamic torque distribution continuously distributes drive power between the front and rear axles depending on weather conditions, road surface and gradient, which increases flexibility for an enhanced, sportier drive.



Standard model equipment

All A4 models have the following items of standard equipment:

Wheels, tyres and suspension

16 x 7.5J '7-arm' design alloy wheels with 225/55 R16 tyres and locking wheel bolts
Space-saver spare wheel

Audio and communication

Audi Chorus audio system – single CD-player with 6.5" monochrome display
6 loudspeakers (80 Watts)

Seats

Cosinus cloth seats with manual height adjustment
Split folding rear seats

Safety and security

ESP
First aid kit
Front and rear fog lights
Front and rear ISOFIX seats with front passenger airbag de-activation switch
Front side airbags
Halogen daytime running lights
Headlight range adjustment
Thatcham category 1 alarm and immobiliser
Toolkit and car jack
Warning triangle

Interior equipment

1-zone climate control
12V power socket in boot
4-spoke leather steering wheel
Door sill trims in Aluminium optic
Driver's Information System (DIS)
Electric front and rear windows
Electromechanical parking brake
Front and rear floor mats
Intelligent key
Micrometallic inlays
Rear armrest
Steering column adjustment for rake and reach

Exterior equipment

Auto-opening boot lid (Saloon models only)
Exterior mirrors – electrically operated and heated
Front grille – Black gloss on 3.0 TDI and 3.2 FSI, Stone grey on all others
Roof rails in bright finish (Avant models only)
Exhaust pipes – 4-cylinder models have two exhaust pipes on the left hand side. 6-cylinder models and the 2.0 TFSI Avant model have one exhaust pipe on each side



16 x 7.5J '7-arm' design alloy wheels with 225/55 R16 tyres



Exterior mirrors – electrically operated and heated

A4 Standard model prices

Petrol – Saloon

Engines	Power	Transmission	Basic RRP	Total RRP ^{inc. VAT}	Recommended OTR
1.8 TFSI	120PS	6-speed manual	£16,255.32	£19,100.00	£19,900.00

Diesel – Saloon

Engines	Power	Transmission	Basic RRP	Total RRP ^{inc. VAT}	Recommended OTR
2.0 TDI	120PS	6-speed manual	£18,212.77	£21,400.00	£22,150.00

Diesel – Avant

Engines	Power	Transmission	Basic RRP	Total RRP ^{inc. VAT}	Recommended OTR
2.0 TDI	120PS	6-speed manual	£19,191.49	£22,550.00	£23,300.00



SE model equipment

In addition to Standard model equipment:

Basic RRP	Total RRP <small>inc. VAT</small>
£851.06	£1,000.00

Wheels, tyres and suspension

17 x 7.5J '7-arm' design alloy wheels with 225/50 R17 tyres and locking wheel bolts

Space-saver spare wheel

Audio and communication

Audi Concert Radio. Single CD with MP3 compatibility, colour centre console screen, SD memory card reader and AUX-IN socket in centre console

Audi sound system speaker package, 10 speakers including subwoofer (180 Watts)

Interior equipment

4-spoke leather multi-function steering wheel

Auto-dimming rear view mirror

Aluminium Hologram Inlays

Deluxe 3-zone climate control with separate air distribution and digital display for driver and front passenger. System includes air-conditioning controls in the rear centre console for rear passenger compartment

Door sill trims in Aluminium optic

Driver's Information System (DIS) in colour

Front centre armrest including 2 x 12V power sockets

Interior chrome package

Safety and security

Automatic headlight operation

Automatic windscreen wipers

Exterior equipment

Exterior aluminium package



Driver's Information System (DIS) in colour



17 x 7.5J '7-arm' design alloy wheels with 225/50 R17 tyres

SE model prices

Petrol – Saloon

Engines	Power	Transmission	Basic RRP	Total RRP ^{inc. VAT}	Recommended OTR
1.8 TFSI	120PS	6-speed manual	£17,106.38	£20,100.00	£20,900.00
1.8 TFSI	160PS	6-speed manual	£18,468.09	£21,700.00	£22,500.00
2.0 TFSI	211PS	6-speed manual	£20,510.64	£24,100.00	£24,875.00
2.0 TFSI quattro	211PS	6-speed manual	£21,702.13	£25,500.00	£26,300.00
3.2 FSI quattro	265PS	6-speed manual	£24,468.09	£28,750.00	£29,590.00

Petrol – Avant

Engines	Power	Transmission	Basic RRP	Total RRP ^{inc. VAT}	Recommended OTR
1.8 TFSI	160PS	6-speed manual	£19,446.81	£22,850.00	£23,650.00
2.0 TFSI	211PS	6-speed manual	£21,489.36	£25,250.00	£26,025.00
2.0 TFSI quattro	211PS	6-speed manual	£22,680.85	£26,650.00	£27,450.00
3.2 FSI quattro	265PS	6-speed manual	£25,446.81	£29,900.00	£30,740.00

Diesel – Saloon

Engines	Power	Transmission	Basic RRP	Total RRP ^{inc. VAT}	Recommended OTR
2.0 TDI	120PS	6-speed manual	£19,063.83	£22,400.00	£23,150.00
2.0 TDI	143PS	6-speed manual	£19,659.57	£23,100.00	£23,850.00
2.0 TDI*	170PS	6-speed manual	£20,510.64	£24,100.00	£24,850.00
2.0 TDI quattro*	170PS	6-speed manual	£21,702.13	£25,500.00	£26,275.00
2.7 TDI	190PS	6-speed manual	£23,446.81	£27,550.00	£28,350.00
3.0 TDI quattro	240PS	6-speed manual	£25,021.28	£29,400.00	£30,200.00

Diesel – Avant

Engines	Power	Transmission	Basic RRP	Total RRP ^{inc. VAT}	Recommended OTR
2.0 TDI	120PS	6-speed manual	£20,042.55	£23,550.00	£24,300.00
2.0 TDI	143PS	6-speed manual	£20,638.30	£24,250.00	£25,000.00
2.0 TDI*	170PS	6-speed manual	£21,489.36	£25,250.00	£26,000.00
2.0 TDI quattro*	170PS	6-speed manual	£22,680.85	£26,650.00	£27,425.00
2.7 TDI	190PS	6-speed manual	£24,425.53	£28,700.00	£29,500.00
3.0 TDI quattro	240PS	6-speed manual	£26,000.00	£30,550.00	£31,350.00

S line model equipment

In addition to SE model equipment:

Basic RRP	Total RRP <small>inc. VAT</small>
£2,127.66	£2,500.00

Wheels, tyres and suspension

18 x 8J '5 spoke' S line design alloy wheels with 245/40 R18 tyres

Sport suspension 20mm lower than Standard.
(S line suspension 30mm lower than Standard. Available in lieu of Sport suspension at no charge)

Space-saver spare wheel

Interior equipment

3-spoke S line multi-function steering wheel
(paddle shift for automatic models)

Black headlining

Matt brushed aluminium inlays

Perforated leather gear knob

S line embossed Sport seats in cloth/leather combination

S line sill plates

Exterior equipment

Bumper 'blade' in Platinum optic

Chrome fog light surround

Chrome rolled exhaust

S line exterior styling package including:

– S line side skirts

– S line front bumper

– S line rear diffuser

– S line badges on wings

Roof spoiler (Avant models only)

Xenon headlights with LED running lights

Additional upholstery information

Option of black or silver stitching to upholstery, steering wheel, gearshift gaiters and floor mats



3-spoke S line steering wheel (paddle shift for automatic models)



18 x 8J '5-spoke' S line design alloy wheels

S line model prices

Petrol – Saloon

Engines	Power	Transmission	Basic RRP	Total RRP ^{inc. VAT}	Recommended OTR
1.8 TFSI	120PS	6-speed manual	£19,234.04	£22,600.00	£23,400.00
1.8 TFSI	160PS	6-speed manual	£20,595.74	£24,200.00	£25,000.00
2.0 TFSI	211PS	6-speed manual	£22,638.30	£26,600.00	£27,375.00
2.0 TFSI quattro	211PS	6-speed manual	£23,829.79	£28,000.00	£28,800.00
3.2 FSI quattro	265PS	6-speed manual	£26,595.74	£31,250.00	£32,090.00

Petrol – Avant

Engines	Power	Transmission	Basic RRP	Total RRP ^{inc. VAT}	Recommended OTR
1.8 TFSI	160PS	6-speed manual	£21,574.47	£25,350.00	£26,150.00
2.0 TFSI	211PS	6-speed manual	£23,617.02	£27,750.00	£28,525.00
2.0 TFSI quattro	211PS	6-speed manual	£24,808.51	£29,150.00	£29,950.00
3.2 FSI quattro	265PS	6-speed manual	£27,574.47	£32,400.00	£33,240.00

Diesel – Saloon

Engines	Power	Transmission	Basic RRP	Total RRP ^{inc. VAT}	Recommended OTR
2.0 TDI	120PS	6-speed manual	£21,191.49	£24,900.00	£25,650.00
2.0 TDI	143PS	6-speed manual	£21,787.23	£25,600.00	£26,350.00
2.0 TDI*	170PS	6-speed manual	£22,638.30	£26,600.00	£27,350.00
2.0 TDI quattro*	170PS	6-speed manual	£23,829.79	£28,000.00	£28,775.00
2.7 TDI	190PS	6-speed manual	£25,574.47	£30,050.00	£30,850.00
3.0 TDI quattro	240PS	6-speed manual	£27,148.94	£31,900.00	£32,700.00

Diesel – Avant

Engines	Power	Transmission	Basic RRP	Total RRP ^{inc. VAT}	Recommended OTR
2.0 TDI	120PS	6-speed manual	£22,170.21	£26,050.00	£26,800.00
2.0 TDI	143PS	6-speed manual	£22,765.96	£26,750.00	£27,500.00
2.0 TDI*	170PS	6-speed manual	£23,617.02	£27,750.00	£28,500.00
2.0 TDI quattro*	170PS	6-speed manual	£24,808.51	£29,150.00	£29,925.00
2.7 TDI	190PS	6-speed manual	£26,553.19	£31,200.00	£32,000.00
3.0 TDI quattro	240PS	6-speed manual	£28,127.66	£33,050.00	£33,850.00

Transmission

multitronic®

Translating a driver's preferences and intentions into road performance, the multitronic® automatic transmission system entertains no compromises – whether in terms of dynamism, convenience or economy. A continuously variable transmission available on front-wheel-drive models, multitronic® operates in an exceptionally wide range of gear ratios thanks to its steel link-plate chain construction. The result is exceptional driving comfort, as well as smooth, powerful acceleration over the entire range of engine speeds. In addition, thanks to its lightweight design and the DRP Dynamic Regulating Programme which monitors gradient, road conditions and the way the driver is using the accelerator pedal, multitronic® also plays an instrumental role in reducing fuel consumption. And with eight simulated gear ratios available, you can enjoy all these benefits whilst adopting the sporty driving style of a manual.

tiptronic®

The 6-speed tiptronic® transmission system is a form of automatic transmission available on A4 models with quattro® permanent four-wheel-drive. The technology incorporates DSP – or the Dynamic Shift Programme which aligns and converts the engine's high power and torque into both sporty performance and operating convenience, with crisp, fast gear changes, reduced weight and optimised gear shifting. In the 'D' (Drive) and 'S' (Sport) programme, the advanced electronics used in tiptronic® respond efficiently to every driver input, helping to prevent unwanted gear-changes. The driver can override automatic mode by moving the gear lever into a tiptronic® shift-gate, enabling spontaneous gear changing for a sportier driving style.



Transmission

Transmission

	1.8 TFSI 120PS	1.8 TFSI 160PS	2.0 TFSI	2.0 TFSI quattro	3.2 FSI quattro	2.0 TDI 120PS	2.0 TDI 143PS	2.0 TDI 170PS	2.0 TDI quattro 170PS	2.7 TDI	3.0 TDI quattro	Basic RRP	Total RRP ^{inc. VAT}
Automatic 8-speed multitronic® transmission	-	•	-	-	-	-	•	-	-	S	-	£1,234.04	£1,450.00
Automatic 6-speed tiptronic® transmission	-	-	-	-	•	-	-	-	-	-	•	£1,191.49	£1,400.00



- = Not available • = Available S = Standard



S line Sports seats in leather/Alcantara with silver stitching



Paint finishes

Standard colours



Brilliant black

A2

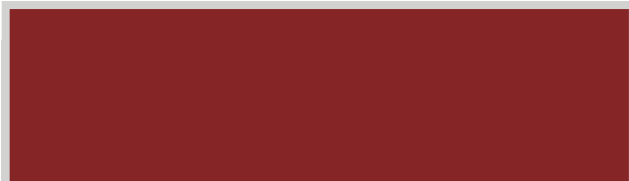

Brilliant red

C8

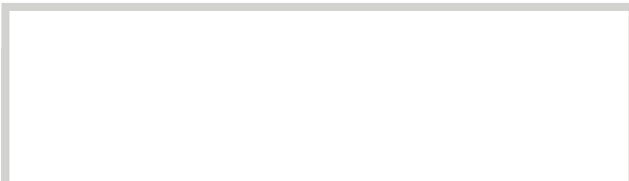

Ibis white

T9

Optional colours

Basic RRP	Total RRP <small>inc. VAT</small>
£468.09	£550.00

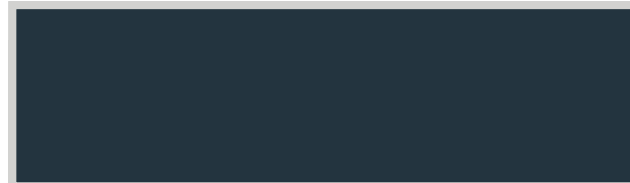

Aruba blue, pearl effect

Q9



Lava grey, pearl effect

1R

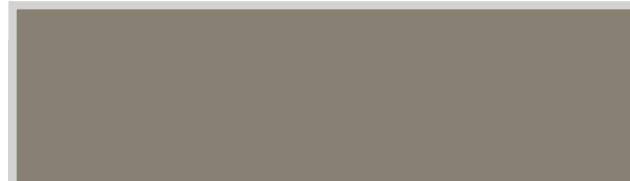

Dakar beige, metallic

9X

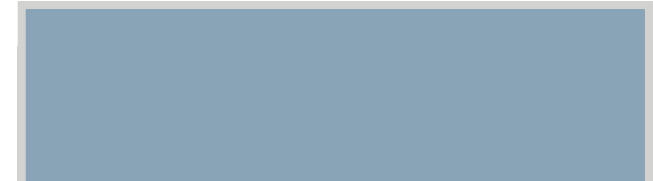

Liquid blue, metallic

Q1

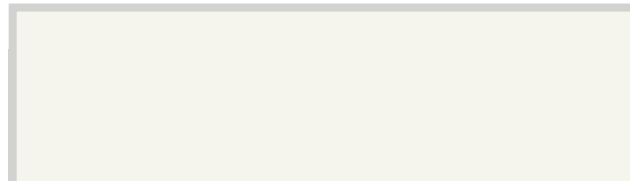

Ice silver, metallic

P5

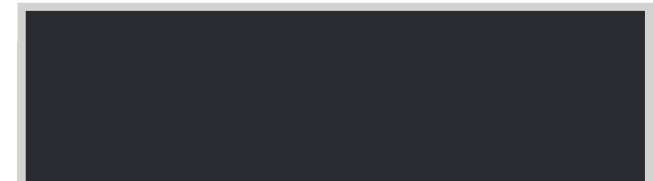

Meteor grey, pearl effect

X5

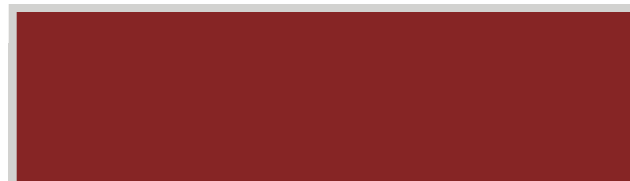

Garnet red, metallic

9C

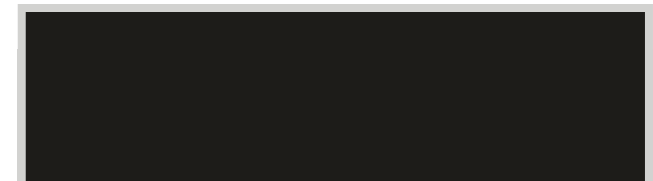

Phantom black, pearl effect

L8

S line additional colours

Basic RRP	Total RRP <small>inc. VAT</small>
£468.09	£550.00



Quartz grey, metallic

Q4



Sphere blue, metallic

9F

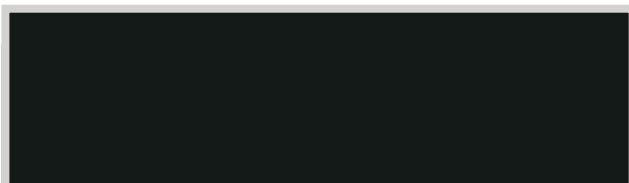

Deep green, pearl effect

3W

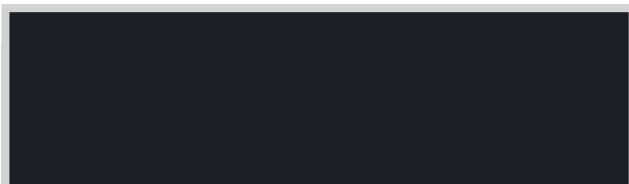

Deep sea blue, pearl effect

8A



Monza silver, metallic

U7













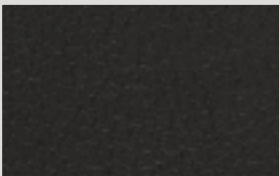

Misano red, pearl effect

N9

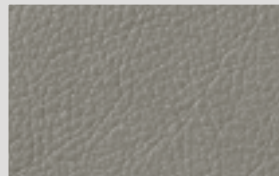



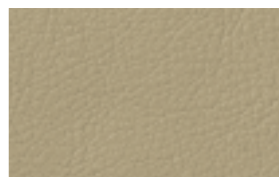
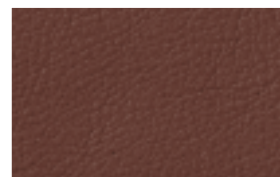





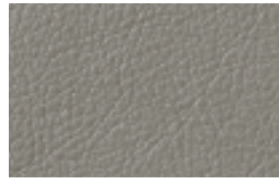

A4 Upholstery

Standard seats

				Standard	SE	S line	Basic RRP	Total RRP ^{inc. VAT}	
				S	S	-	No charge	No charge	
Cosinus cloth, Black GD	Cosinus cloth, Light grey GQ								
					•	•	£102.13	£120.00	
Arkana cloth, Black GD	Arkana cloth, Grey GQ	Arkana cloth, Cardamom beige GR							
						•	•	£1,097.87	£1,290.00
Milano leather, Black GD	Milano leather, Mustang brown GP	Milano leather, Light grey GQ	Milano leather, Cardamom beige GR						
						•	•	£1,395.74	£1,640.00
Valcona leather, Black GD	Valcona leather, Light grey GQ	Valcona leather, Luxor beige GM	Valcona leather, Mustang brown GP						
									
Valcona leather, Cardamom beige GR									

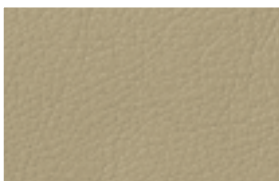
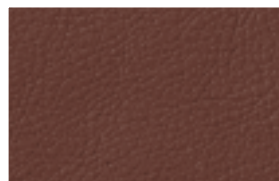



Sports seats (front, with 4-way electrical lumbar adjustment and manual height adjustment)

				Standard	SE	S line	Basic RRP	Total RRP ^{inc. VAT}				
	GD		GQ	•	•	-	£404.26	£475.00				
Empore cloth, Black		Empore cloth, Light grey										
	GD		GP		GQ		GR	•	•	-	£1,502.13	£1,765.00
Milano leather, Black		Milano leather, Mustang brown		Milano leather, Light grey		Milano leather, Cardamom beige						
	GD		GQ	•	•	-	£1,182.98	£1,390.00				
Leather/Alcantara, Black		Leather/Alcantara, Light grey										
	GD		GM		GP		GQ	•	•	-	£1,800.00	£2,115.00
Valcona leather, Black		Valcona leather, Luxor beige		Valcona leather, Mustang brown		Valcona leather, Light grey						
	GR											
Valcona leather, Cardamom beige												

All leather upholstery choices include seats, head restraints, door inserts and front centre armrest (if fitted) in leather. Alcantara/leather choices include head restraints, seat side bolsters and front centre armrest (if fitted) in leather with the seat centres and door inserts in alcantara.

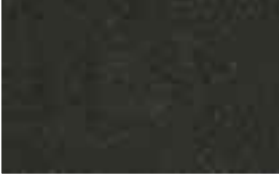
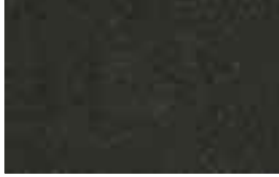

A4 Upholstery

S line Sports Seats (front, with 4 way electrical lumbar adjustment and manual height adjustment, front seats with 'S line' logo available with black stitching on all upholsteries and silver stitching on Leather/Cloth and Leather/Alcantara upholsteries)

		Standard	SE	S line	Basic RRP	Total RRP ^{inc. VAT}
	QE	-	-	S	No charge	No charge
Leather/Cloth, Black* QE	QE	-	-	•	£404.26	£475.00
	QF	-	-	•	£723.40	£850.00
Leather/Cloth, Black with silver stitching* QF	QF	-	-	•	£1,021.28	£1,200.00
	QE	-	-	•		
Leather/Alcantara, Black QE	QE	-	-	•		
	QF	-	-	•		
Leather/Alcantara, Black with silver stitching QF	QF	-	-	•		
	QE	-	-	•		
Milano Leather, Black QE	QE	-	-	•		
	QE	-	-	•		
Valcona Leather, Black QE	QE	-	-	•		

A4 Upholstery

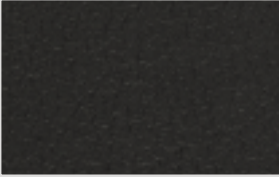
Climate Comfort seats. (Climate-controlled front seats can be heated or cooled according to the driver and passenger's requirements. Includes electrically-adjustable front seats and memory function for driver's seat. Door mirrors – electrically folding and auto-dimming with memory function, and auto-dimming rear view mirror. Only available in Milano leather.)

		Standard	SE	S line	Basic RRP	Total RRP <small>inc. VAT</small>
	GD	•	•	–	£3,353.19	£3,940.00
	GP					
	GQ					
	GR					



Sports seats in black Valcona leather (GD), micrometallic inlays (5MA) and DVD-based Satellite Navigation system

All leather upholstery choices include seats, head restraints, door inserts and front centre armrest (if fitted) in leather.

Colour and trim guide

To help you choose the right colours for you and your A4, please use the guide below to ensure your preferred colours and trims are well matched.

Standard seats – Interior trim colours:

Order code	Upholstery	Carpet	Dashboard (upper/lower)	Headlining	Cosinus cloth (N2M)	Arkana cloth (N0L)	Milano leather (N5W)	Valcona leather (N5D)
GD	Black	Black	Black/Black	Star silver	●	●	●	●
GM	Luxor beige	Black	Black/Black	Black	–	–	–	●
GP	Mustang brown	Black	Black/Black	Star silver	–	–	●	●
GQ	Light grey	Quartz grey	Graphite grey/Graphite grey	Star silver	●	●	●	●
GR	Cardamom beige	Coriander beige	Tan beige/Tan beige	Linen beige	–	●	●	●

Sports seats – Interior trim colours:

Order code	Upholstery	Carpet	Dashboard (upper/lower)	Headlining	Empore cloth (N5F)	Alcantara/leather (N7U)	Milano leather (N5W)	Valcona leather (N5D)
GD	Black	Black	Black/Black	Star silver	●	●	●	●
GM	Luxor beige	Black	Black/Black	Black	–	–	–	●
GP	Mustang brown	Black	Black/Black	Star silver	–	–	●	●
GQ	Light grey	Quartz grey	Graphite grey/Graphite grey	Star silver	●	●	●	●
GR	Cardamom beige	Coriander beige	Tan beige/Tan beige	Linen beige	–	–	●	●

S line Sports seats – Interior trim colours:





Order code	Upholstery	Carpet	Dashboard (upper/lower)	Headlining	Cloth / Leather (N7V)	Alcantara/leather (N7K)	Milano leather (N1Y)	Valcona leather (N1V)
QE (Black stitching)	Black	Black	Black/Black	Black	●	●	●	●
QF (Silver stitching)	Black	Black	Black/Black	Black	●	●	–	–

Comfort seats – Interior trim colours:



Order code	Upholstery	Carpet	Dashboard (upper/lower)	Headlining	Milano leather (N5W)
GD	Black	Black	Black/Black	Star silver	●
GM	Luxor beige	Black	Black/Black	Black	–
GP	Mustang brown	Black	Black/Black	Star silver	●
GQ	Light grey	Quartz grey	Graphite grey/Graphite grey	Star silver	●
GR	Cardamom beige	Coriander beige	Tan beige/Tan beige	Linen beige	●



Inlays

Order code			Standard	SE	S line	Basic RRP	Total RRP <small>inc. VAT</small>
5MA		Micrometallic platinum	S	-	-	No charge	No charge
PDC		Aluminium hologram (with Aluminium optics for centre console and electromechanical parking brake)	•	S	-	£127.66	£150.00
PDD		Walnut brown (with Aluminium optics for centre console and electromechanical parking brake)	• -	- •	- -	£276.60 £123.40	£325.00 £145.00
PDF		Fine grain ash, Almond beige (with Aluminium optics for centre console and electromechanical parking brake)	• -	- •	- -	£276.60 £123.40	£325.00 £145.00
PDK		Laurel nutmeg (with Aluminium optics for centre console and electromechanical parking brake)	• -	- •	- -	£276.60 £123.40	£325.00 £145.00

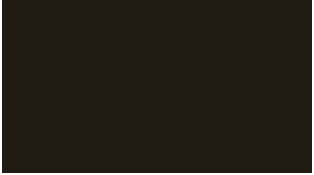
Inlays

Order code			Standard	SE	S line	Basic RRP	Total RRP ^{inc. VAT}
5TG		Matt-brushed aluminium (with Aluminium optics for light switches, centre console and electromechanical parking brake)	-	-	S	No charge	No charge
5TL		Piano black (with Aluminium optics for light switches, centre console and electromechanical parking brake)	-	-	•	No charge	No charge
5TW		Vavona wood Assam grey (with Aluminium optics for light switches, centre console and electromechanical parking brake)	-	-	•	£276.60	£325.00





Wheels, tyres and suspension

Order code		Standard	SE	S line	Basic RRP	Total RRP <small>inc. VAT</small>
PRY	17 x 7.5J '7-arm' design alloy wheels with 225/50 R17 tyres	•	S	-	£382.98	£450.00
PRE	17 x 7.5J '6-spoke' design alloy wheels with 225/50 R17 tyres	• -	- •	- -	£468.09 £85.11	£550.00 £100.00
PRT	17 x 8J '10-spoke' design alloy wheels with 245/45 R17 tyres	• -	- •	- -	£638.30 £255.32	£750.00 £300.00
PRD	18 x 8J '5-spoke star' design alloy wheels with 245/40 R18 tyres	-	•	-	£510.64	£600.00
PQH	18 x 8J '15-spoke' design alloy wheels with 245/40 R18 tyres	-	•	-	£510.64	£600.00
PQF	19 x 8.5J '7-arm double spoke' design alloy wheels with 255/35 R19 tyres (cannot be combined with Audi drive select with damper control, Audi drive select – full package or S line Sports suspension 30mm lowered)	-	-	•	£553.19	£650.00
PQS	19 x 8.5J '20 spoke' design alloy wheels with 255/35 R19 tyres (cannot be combined with Audi drive select with damper control, Audi drive select – full package or S line Sports suspension 30mm lowered)	-	-	•	£553.19	£650.00
1N3	servotronic power steering (standard on 190PS and above models)	-	•	•	£153.19	£180.00



17 x 7.5J '6-spoke' design alloy wheels



17 x 8J '10-spoke' design alloy wheels



18 x 8J '5-spoke star' design alloy wheels

Options are subject to availability and may extend delivery.
 - = Not available • = Available S = Standard

Wheels, tyres and suspension

Order code		Standard	SE	S line	Basic RRP	Total RRP <small>inc. VAT</small>
2H1 IN7	Audi drive select with dynamic steering (only available on 143PS models and above)	-	●	-	£851.06	£1,000.00
		-	-	●	£510.64	£600.00
2H1 1BL	Audi drive select with damper control (only available with servotronic steering)	-	●	-	£851.06	£1,000.00
		-	-	●	£510.64	£600.00
2H1 1BL 1N7	Audi drive select – Full package with damper control and dynamic steering (only available on 143PS models and above)	-	●	-	£1,446.81	£1,700.00
		-	-	●	£1,106.38	£1,300.00

Dynamic steering

With this new technology, driving is significantly more agile under everyday conditions, while directional stability and precision are increased at high speeds and in demanding driving situations.

Damper control

The optional damper control system makes individual settings for suspension tunings possible. A lowered sports suspension forms the basis. Adjustable hydraulic dampers alter the damper characteristics individually for each wheel.



Audio and communication

Order code		Standard	SE	S line	Basic RRP	Total RRP ^{inc. VAT}
8UD	Audi Concert radio. Single CD with MP3 compatibility, colour centre console screen, SD memory card reader and AUX-IN socket in centre console	•	S	S	£255.32	£300.00
8UM	Audi Symphony radio, with front-loading MP3-compatible 6-CD changer, colour centre console screen, SD memory card reader and AUX-IN socket in centre console	• -	- •	- •	£480.85 £234.04	£565.00 £275.00
9VK	Bang & Olufsen sound system, designed specifically for the A4, providing surround-sound reproduction with dynamic-noise compensation, 14 high-performance loudspeakers (505 Watt) and 10-channel amplifier	-	•	•	£446.81	£525.00
QV3	DAB digital radio	-	•	•	£255.32	£300.00
QV9	TV reception – analogue and digital (only in combination with Satellite Navigation system Plus)	-	•	•	£723.40	£850.00
7D3	Audi Music Interface (AMI). Universal connection for use with stereo audio sources and Apple iPod generation 4 onwards (iPod, iPod mini, iPod nano, iPod photo, iPod video). Provides intuitive control through the audio system and multi-function steering wheel. It also replicates the iPod display on the audio screen, including track titles. The interface provides power as well as a convenient rubberised storage tray. An adapter cradle is required at additional cost. Please consult your Audi Centre for details. Must be combined with Concert or Symphony Radio or DVD Satellite Navigation Plus	-	•	•	£170.21	£200.00
PNA	Satellite Navigation system Plus. DVD-based route planning and guidance with MMI, radio, CD-changer and European-coverage TMC-enabled DVD. (With this feature installed the MMI controls move from sound system head-unit to around the gear lever)	-	•	•	£1,680.85	£1,975.00



6-CD in-dash changer – part of Satellite Navigation system Plus



Satellite Navigation system Plus

Audio and communication

Order code		Standard	SE	S line	Basic RRP	Total RRP <small>inc. VAT</small>
PT5	Mobile telephone preparation – Low. In front centre armrest, uses Bluetooth interface or cradle to connect to your A4, including roof aerial for optimal reception. Includes centre armrest for Standard trim models. A phone cradle is required for charging your phone, at extra cost, please see your Audi Centre for phone compatibility. (Cannot be combined with Chorus radio)	● -	- ●	- ●	£446.81 £319.15	£525.00 £375.00
9ZW	Mobile telephone preparation – High. Uses Bluetooth interface with no physical connection to your A4, including roof aerial for optimal reception. Please note that your mobile phone must have SIM-Access Profile facility for full functionality. (Only in combination with Satellite Navigation system Plus)	-	●	●	£553.19	£650.00
PT4	Mobile telephone preparation – High (with privacy handset). The handset allows passengers to make private calls, provides remote control of the telephone functions as well as convenient SMS text messaging function. The handset is charged from a docking station integrated into the front centre armrest. (Only in combination with Satellite Navigation system Plus)	-	●	●	£808.51	£950.00
QH3	Voice Control System. Operates key basic functions of Satellite Navigation system Plus. (Only in combination with Satellite Navigation system Plus)	-	●	●	£276.60	£325.00
9WM	Rear Seat Entertainment Package fitted to the back of the A4 front seats. The package includes 2 detachable DVD players/monitors (supplied by Audi Genuine Accessories) that can be used both inside and outside of the A4. The driver and passenger front seats are fitted with the mountings and power connection for the DVD players for when the entertainment system is used inside the A4. Usage outside of the Audi A4 is via a rechargeable battery or mains power connection that is included in the package. Includes individual remote controls	-	●	●	£846.81	£995.00



Mobile telephone preparation – High (with Privacy Handset)



MMI Control – position when combined with Satellite Navigation system Plus



Rear Seat Entertainment Package

Seats

Order code		Standard	SE	S line	Basic RRP	Total RRP <small>inc. VAT</small>
PV1	Electric front seats , with adjustment for height, forwards and backwards position, backrest angle and lumbar support for driver and front-passenger seats	● -	● -	- ●	£638.30 £442.55	£750.00 £520.00
PV3 6XL	Comfort pack . Comprising electric front seats with lumbar support, memory function on driver's side, door mirrors – electrically folding and auto-dimming with memory function, auto-dimming rear view mirror	- -	● -	- ●	£1,191.49 £995.74	£1,400.00 £1,170.00
7P1	Electric lumbar support for front seats , with horizontal and vertical adjustment	●	●	S	£195.74	£230.00
4A3	Heated front seats , individually controlled seatbase and bolster heating with variable temperature adjustment	●	●	●	£212.77	£250.00
4A4	Heated front and rear seats , individually controlled seatbase and bolster heating with variable temperature adjustment. (Not available with cloth upholstery)	●	●	●	£382.98	£450.00



Safety and security

Order code		Standard	SE	S line	Basic RRP	Total RRP <small>inc. VAT</small>
7X4	Audi Parking System Plus. Aids parking by acoustically and graphically indicating distances to obstacles in front of and behind your A4	-	•	•	£553.19	£650.00
7X8	Audi Parking System Advanced. Aids parking by acoustically and visually indicating distances to obstacles in front of and behind your A4 with guiding lines. Measured by ultrasonic sensors with camera integrated discreetly in the boot handle. (Only in combination with Satellite Navigation system Plus)	-	•	•	£893.62	£1,050.00
7Y1	Audi side assist. Aids the driver when changing lane. Audi side assist monitors the area behind your A4, using radar sensors located discreetly in the rear bumper and informs the driver with a visual warning signal in the door mirror if there is a vehicle in the driver's blind spot or approaching quickly from behind. The system is activated using a button in the driver's door	-	•	•	£382.98	£450.00
7Y2	Audi lane assist. Uses a discreet camera at the top of the windscreen to monitor the road ahead. The driver is warned with a vibration of the steering wheel if the vehicle is about to exit the lane unintentionally. (Only in combination with 4-spoke multi-function steering wheel)	-	•	•	£382.98	£450.00
6XK	Exterior mirrors – heated, electrically-folding and with auto-dimming function	-	•	•	£127.66	£150.00
8Q5	Adaptive lights – Swivelling headlights for improved illumination of winding roads	-	-	•	£276.60	£325.00
VC1	Garage door opener (Homelink*). Programmable radio-operated remote control for compatible doors/gates. Control buttons integrated in the front roof module	•	•	•	£148.94	£175.00
UH2	Audi Hill-Hold assist. Automatically activates electromechanical parking brake when stationary	•	•	•	£38.30	£45.00
4X4	Rear side airbags	•	•	•	£212.77	£250.00
7K6	Tyre pressure monitoring display	-	•	•	£63.83	£75.00

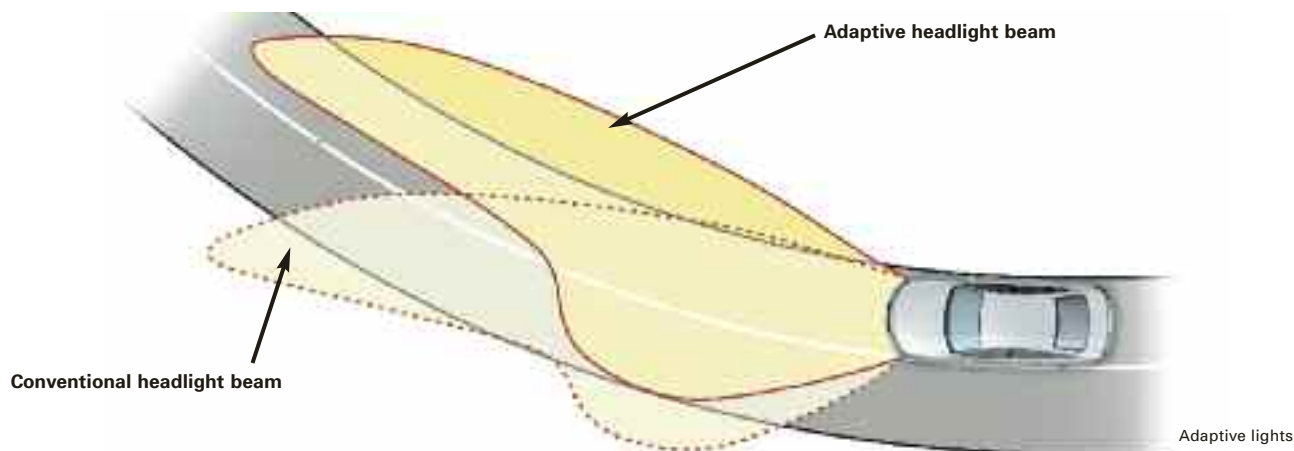

Interior equipment

Order code		Standard	SE	S line	Basic RRP	Total RRP <small>inc. VAT</small>
4K7	Advanced key. Access and authorisation system which automatically exchanges data between key and vehicle, allowing the driver to keep the key in their pocket or bag at all times. To unlock and open, simply lift the exterior doorhandle. To lock, press the button on the handle. Pressing the start/stop button integrated into the centre console starts and stops the engine	-	•	•	£421.28	£495.00
6NQ	Black headlining	•	•	S	£170.21	£200.00
QE1	Storage pack. Includes storage nets on the front-seat backrests, storage compartment under the front seats (if memory function is fitted, only under the front-passenger seat), drinks holder in the rear centre armrest and a locking glove compartment	•	•	•	£85.11	£100.00
6E3	Front centre armrest including 2 x 12V power sockets	•	S	S	£136.17	£160.00
3X2	Ski bag with through-load facility	•	•	•	£136.17	£160.00
3Y2	Blind – electric for rear window (Saloon models only)	•	•	•	£200.00	£235.00
3Y4	Blind – manual for rear side windows	•	•	•	£85.11	£100.00
8T1	Cruise Control	•	•	•	£161.70	£190.00
8T4	Adaptive cruise control (ACC). Automatic distance regulation, uses radar sensors to maintain required distance by braking and accelerating. Four programs (distance 1 to distance 4) set via steering column controls of the cruise control system	-	•	•	£936.17	£1,100.00
QQ1	Interior light pack. Includes rear reading lights, entrance lights, front footwell lights, active door reflectors, vanity mirrors and illumination of the glove compartment, vents and internal door controls	•	•	•	£140.43	£165.00
6SJ	Reversible load mat with bumper cover. One side in rubber, the other in carpet. (Avant models only)	•	•	•	£72.34	£85.00
3GN	Load area rail system and fixing kit. Includes load area rails, telescopic bar and securing belt for dividing the luggage compartment. (Avant models only)	•	•	•	£127.66	£150.00

Exterior equipment

Order code		Standard	SE	S line	Basic RRP	Total RRP <small>inc. VAT</small>
3FE	Electric slide and tilt sunroof (Saloon models only)	•	•	•	£723.40	£850.00
1D2	Tow-bar, factory-fitted and removable	•	•	•	£553.19	£650.00
2Z0	Deletion of model and engine capacity designation at rear	•	•	•	No charge	No charge
2Z7	Deletion of engine capacity at rear	•	•	•	No charge	No charge
4E9	Power-operated tailgate (Avant models only)	•	•	•	£319.15	£375.00
3FU	Open sky panoramic sunroof (Avant models only)	•	•	•	£936.17	£1,100.00

Options are subject to availability and may extend delivery.
 - = Not available • = Available S = Standard

Steering wheels

Order code		Standard	SE	S line	Basic RRP	Total RRP ^{inc. VAT}
2ZQ	Steering wheel – leather 4-spoke multi-function	●	S	-	£127.66	£150.00
2ZS	Steering wheel – leather 4-spoke multi-function with paddle shift for auto-transmission (only in combination with Audi lane assist)	-	●	-	£119.15	£140.00
1XX	Steering wheel – leather Sports 3-spoke multi-function with paddle shift for auto-transmission	-	●	-	£204.26	£240.00
1XW	Steering wheel – leather Sports 3-spoke multi-function	-	●	-	£85.11	£100.00





Every Audi is intrinsically exclusive. It's the breathtaking design, the exceptional engineering, the Vorsprung durch Technik. But for that added element of exclusivity – that distinguishing look that sets you apart from the rest – you can specify your new A4 with options from Audi exclusive. Whether you want a completely unique, custom-mixed paint colour or seats in a combination of complementary shades, Audi exclusive will enable you to drive the car you've always imagined.

For more information on any of the options over the following pages or to view swatches, simply ask a member of staff at your local Audi Centre.



Upholstery

With Audi exclusive, you can choose between Fine Nappa leather and Alcantara, depending on the texture and flexibility you prefer in your car's upholstery. And once that's decided, you can specify your seats in an array of different colours shown to the left.

Choose just one all-over shade for each seat, or for a sportier look, customise each panel in two or more complementary colours from the distinctive Audi exclusive palette shown here. You can even choose the colour of the decorative stitching – to match or contrast with your chosen upholstery – from this varied collection. Whatever combination you decide upon, you're guaranteed to be extremely comfortable with the result.

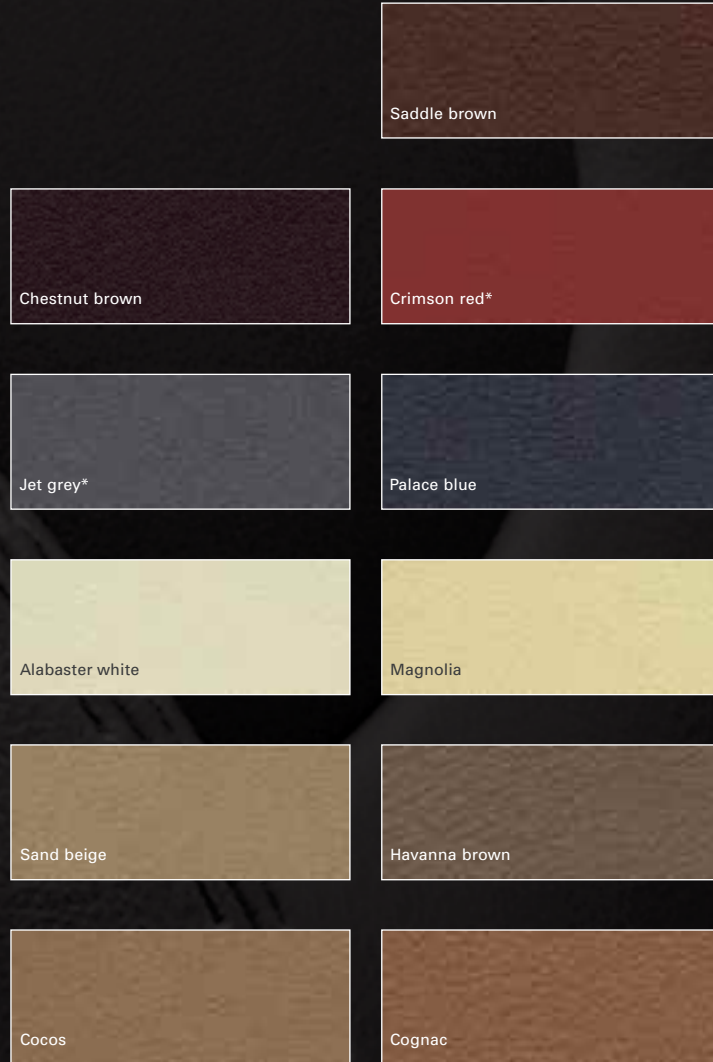

	Standard	SE	S line	Basic RRP	Total RRP ^{inc. VAT}
Valcona leather – front and back seats, head restraints, door trim inserts, front centre armrest (if ordered), seat side trims and add-on seat parts are leather-covered and colour-coordinated (only in conjunction with interior code "GD")	-	•	•	£3,191.49	£3,750.00
Valcona leather/Alcantara – front and back seats, head restraints, door trim inserts, front centre armrest (if ordered), seat side trims and add-on seat parts are leather-covered and colour-coordinated (only in conjunction with interior code "GD"). Cannot be combined with Comfort front seats)	-	•	•	£3,191.49	£3,750.00
Valcona leather – front and back seats, head restraints, door trim inserts, front and rear centre armrest, seat side trims and add-on seat parts are leather-covered and colour-coordinated (only in conjunction with interior code "GD")	-	•	•	£3,617.02	£4,250.00

*Not available in Alcantara.
 - = Not available • = Available



Palace blue, pearl effect

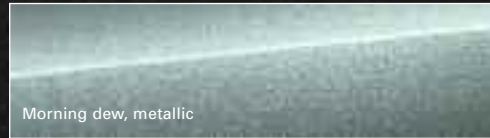

Morning dew, metallic

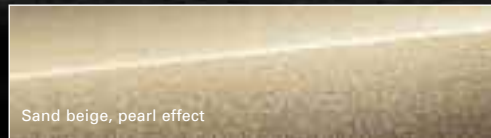

Sand beige, pearl effect

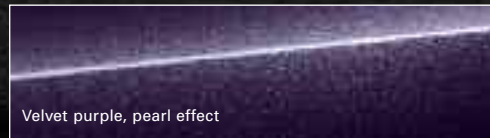

Velvet purple, pearl effect



Oak green, metallic

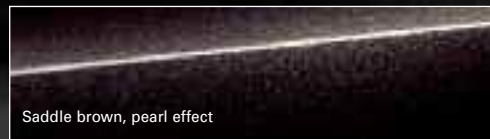

Saddle brown, pearl effect



Classic red, pearl effect

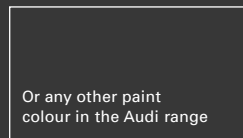

Or any other paint colour in the Audi range

Paint

Everyone has a favourite colour. No matter what yours is, Audi exclusive provides a range of unique colours that have been designed to set your car apart. Choose from the swatches here, or specify any other paint colour in the Audi range – whether it's Jet blue from the Audi R8 or Alpine white from the original Audi quattro®. The choice is yours.

Standard	SE	S line	Basic RRP	Total RRP ^{inc. VAT}
I	•	•	£1,446.81	£1,700.00

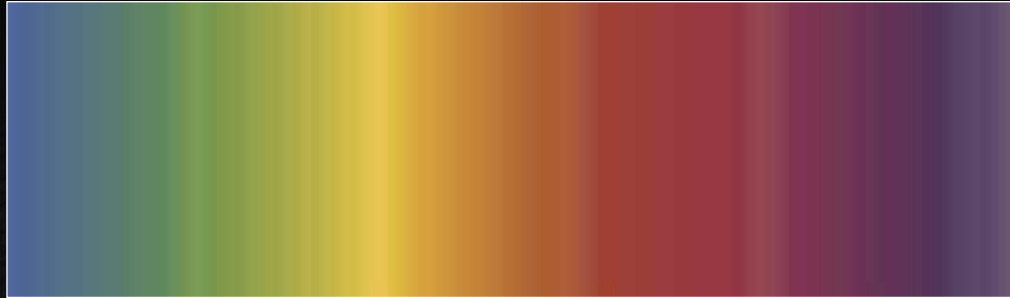

Customised paint

In a car made from Vorsprung durch Technik, there are no compromises. So if you have a particular colour in mind, we'll mix the exact metallic or pearl-effect shade you want – whether it's the blue of your favourite shirt or the wall colour in your sitting room.

Standard	SE	S line	Basic RRP	Total RRP <small>inc. VAT</small>
I	•	•	£2,042.55	£2,400.00

Inlays

Inlays are the all-important 'finishing touch' that add flair and interest to the surfaces inside your car. So Audi exclusive have sourced a hugely varied range of materials from which to craft these elements – from Oak sepia to rich quilted maple wood. You can even customise your gear knob with one of the available woods, all of which are shown opposite.

	Basic RRP	Total RRP <small>inc. VAT</small>
Inlays	£638.30	£750.00

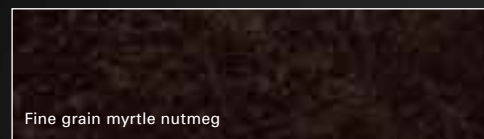
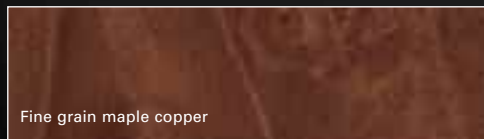

Steering wheels and controls pack

Our fingertips and palms contain more touch receptors than any other part of our body – so shouldn't the parts of our car we handle the most also be the most pleasing to touch? With this in mind, Audi exclusive enables you to customise the steering wheel of your choice in smooth, warm leather, in any of the colours shown on page 39. As with Audi exclusive seats, you even have free choice on the colour of the decorative stitching used. Choose a controls pack and you can extend this exclusive look and feel to your car's handbrake, gearknob and gaiter too.

	Standard	SE	S line	Basic RRP	Total RRP <small>inc. VAT</small>
Steering wheel	-	•	•	£297.87	£350.00
Steering wheel – Part-wood, part-leather	-	•	•	£510.64	£600.00
Controls pack	-	•	•	£510.64	£600.00



Carpets and floor mats

Exclusivity isn't just about choice and individuality – it's about attention to every detail in your A4; and for us, that includes the carpets and floor mats. First, choose from eleven different colours of high-quality velour carpets. Next, choose the colour of your car's floor mats from the same list, whilst using the palette of Audi upholstery colours detailed on page 39 to select a leather colour for the mats' decorative leather piping – matched or contrasting, depending on your personal taste. Floor mats are included when you order Audi exclusive carpet; but if you wish, they can also be purchased separately in a set of four.

	Standard	SE	S line	Basic RRP	Total RRP <small>inc. VAT</small>
Carpets	-	•	•	£723.40	£850.00
Floor mats	-	•	•	£255.32	£300.00



Technical data

A4 – Saloon

Petrol									
Engine	Cylinder	Displacement, cubic cm (valves per cylinder)	Max. power ¹ , PS	Max. torque, Nm at rpm	Transmission	CO ₂ emissions ² , g/km	0-62mph acceleration, seconds	Top speed, mph	ABI insurance group
1.8 TFSI	4-cylinder	1798	120	230/1500-3650	6-speed manual	169	10.5	130	11E
1.8 TFSI	4-cylinder	1798	160	250/1500-4500	6-speed manual	169	8.6	140	14E
1.8 TFSI	4-cylinder	1798	160	250/1500-4500	multitronic®	169	8.6	140	14E
2.0 TFSI	4-cylinder	1984	211	350/1500-4200	6-speed manual	154	6.9	155	15E
2.0 TFSI quattro	4-cylinder	1984	211	350/1500-4200	6-speed manual	173	6.6	153	16E
3.2 FSI quattro	V6	3197	265	330/3000-5000	6-speed manual	213	6.2	155	16E
3.2 FSI quattro	V6	3197	265	330/3000-5000	tiptronic®	215	6.4	155	16E

Diesel									
2.0 TDI	4-cylinder	1968	120	290/1750-2500	6-speed manual	134	10.7	127	11E
2.0 TDI	4-cylinder	1968	143	320/1750-2500	6-speed manual	139	9.4	134	12E
2.0 TDI	4-cylinder	1968	143	320/1750-2500	multitronic®	154	9.4	134	12E
2.0 TDI	4-cylinder	1968	170	350/1750-2500	6-speed manual	140	8.3*	143	TBC
2.0 TDI quattro	4-cylinder	1968	170	350/1750-2500	6-speed manual	156	8.3*	140	TBC
2.7 TDI	V6	2698	190	400/1400-3250	multitronic®	167	7.7	140	15E
3.0 TDI quattro	V6	2967	240	500/1500-3000	6-speed manual	172	6.1	155	16E
3.0 TDI quattro	V6	2967	240	500/1500-3000	tiptronic®	182	6.2	155	16E

*Provisional data.

¹The given value was obtained in accordance with the specified measurement procedure (the respective current version of the Directive 80/1269/EEC).

²The given values were calculated in accordance with the specified measurement procedure (the respective current version of Directive 80/1268/EEC). This information does not relate to a single vehicle and does not comprise part of the offer but is merely intended for the purpose of comparison between the different vehicle types. Data is provisional.

Unladen weight ³	Weights, kg		Max. trailer load ⁴ , kg			Volumes		Fuel tank capacity approx, litres	Fuel consumption, mpg (l/100km)		
	Gross weight limit	Roof load limit/nose weight	unbraked	with 12% gradient	with 8% gradient	Luggage compartment capacity, cubic litres	Rear seats upright		Rear seats folded	Urban	Extra Urban
1410	1960	75/80	740	1300	1500	480	962	65	28.5 (9.9)	51.4 (5.5)	39.8 (7.1)
1410	1960	75/80	740	1300	1500	480	962	65	29.4 (9.6)	49.6 (5.7)	39.8 (7.1)
1410	1960	75/80	740	1300	1500	480	962	65	30.1 (9.4)	47.9 (5.9)	37.2 (7.6)
1435	1985	75/80	750	1500	1700	480	962	65	31.4 (9.0)	54.3 (5.2)	42.8 (6.6)
1520	2070	75/80	750	1700	1900	480	962	65	28.2 (10.0)	47.9 (5.9)	38.2 (7.4)
1580	2130	75/80	750	1900	2100	480	962	64	21.7 (13.0)	42.8 (6.6)	31.7 (8.9)
1610	2165	75/80	750	1900	2100	480	962	64	21.7 (13.0)	42.2 (6.7)	31.4 (9.0)
1465	2015	75/80	750	1300	1500	480	962	65	42.2 (6.7)	68.9 (4.1)	55.4 (5.1)
1460	2010	75/80	750	1700	1900	480	962	65	40.9 (6.9)	64.2 (4.4)	53.3 (5.3)
1495	2045	75/80	750	1700	1900	480	962	65	36.2 (7.8)	60.1 (4.7)	48.7 (5.8)
1460	2010	75/80	750	1600*	1800*	480	962	65	40.4 (7.0)	64.2 (4.4)	53.3 (5.3)
1555	2015	75/80	750	1600*	1800*	480	962	64	36.7 (7.7)	57.6 (4.9)	47.9 (5.9)
1595	2145	75/80	750	1700	1900	480	962	65	36.2 (7.8)	51.4 (5.5)	44.1 (6.4)
1655	2205	75/80	750	1900	2100	480	962	64	32.1 (8.8)	53.3 (5.3)	42.8 (6.6)
1690	2240	75/80	750	1900	2100	480	962	64	32.8 (8.6)	47.9 (5.9)	40.9 (6.9)

³Vehicle's unladen weight without driver (calculated in accordance with the current version of Directive 80/1268/EEC). The fitting of additional equipment may increase the vehicle's unladen weight and drag coefficient, whereupon the potential carrying capacity and top speed will be correspondingly reduced.

⁴The engine's power output always goes down with increasing altitude. At 1,000m above sea level, and for every additional 1,000m, deduct 10% from the weight of the outfit (trailer load limit + gross weight of the towing vehicle).

Technical data

A4 – Avant

Petrol									
Engine	Cylinder	Displacement, cubic cm (valves per cylinder)	Max. power ¹ , PS	Max. torque, Nm at rpm	Transmission	CO ₂ emissions ² , g/km	0-62mph acceleration, seconds	Top speed, mph	ABI insurance group
1.8 TFSI	4-cylinder	1798	160	250/1500-4500	6-speed manual	170	8.9	140	14E
1.8 TFSI	4-cylinder	1798	160	250/1500-4500	multitronic®	175	8.9	138	14E
2.0 TFSI	4-cylinder	1984	211	350/1500-4200	6-speed manual	160	7.1	150	15E
2.0 TFSI quattro	4-cylinder	1984	211	350/1500-4200	6-speed manual	177	6.7	148	16E
3.2 FSI quattro	V6	3197	265	330/3000-5000	6-speed manual	216	6.4	155	16E
3.2 FSI quattro	V6	3197	265	330/3000-5000	tiptronic®	219	6.6	155	16E

Diesel

2.0 TDI	4-cylinder	1968	120	290/1750-2500	6-speed manual	140	11.2	122	11E
2.0 TDI	4-cylinder	1968	143	320/1750-2500	6-speed manual	143	9.7	130	12E
2.0 TDI	4-cylinder	1968	143	320/1750-2500	multitronic®	159	9.7	125	12E
2.0 TDI	4-cylinder	1968	170	350/1750-2500	6-speed manual	149	8.6*	140	TBC
2.0 TDI quattro	4-cylinder	1968	170	350/1750-2500	6-speed manual	162	8.6*	138	TBC
2.7 TDI	V6	2698	190	400/1400-3250	multitronic®	170	8.3	140	15E
3.0 TDI quattro	V6	2967	240	500/1500-3000	6-speed manual	179	6.3	155	16E
3.0 TDI quattro	V6	2967	240	500/1500-3000	tiptronic®	189	6.3	155	16E

*Provisional data.

¹The given value was obtained in accordance with the specified measurement procedure (the respective current version of the Directive 80/1269/EEC).

²The given values were calculated in accordance with the specified measurement procedure (the respective current version of Directive 80/1268/EEC). This information does not relate to a single vehicle and does not comprise part of the offer but is merely intended for the purpose of comparison between the different vehicle types. Data is provisional.

Unladen weight ³	Weights, kg		Max. trailer load ⁴ , kg			Volumes		Fuel tank capacity approx, litres	Fuel consumption, mpg (l/100km)		
	Gross weight limit	Roof load limit/nose weight	unbraked	with 12% gradient	with 8% gradient	Luggage compartment capacity, cubic litres	Rear seats upright		Rear seats folded	Urban	Extra Urban
1470	2040	90/80	750	1300	1500	490	1430	65	29.4 (9.6)	48.7 (5.8)	39.2 (7.2)
1510	2080	90/80	750	1300	1500	490	1430	65	29.4 (9.6)	46.3 (6.1)	38.2 (7.4)
1495	2065	90/80	750	1500	1700	490	1430	65	31.0 (9.1)	52.3 (5.4)	41.5 (6.8)
1565	2135	90/80	750	1700	1900	490	1430	65	28.0 (10.1)	46.3 (6.1)	37.2 (7.1)
1630	2200	90/80	750	1900	2100	490	1430	64	21.7 (13.0)	41.5 (6.8)	31.0 (9.1)
1660	2230	90/80	750	1900	2100	490	1430	64	21.6 (13.1)	40.9 (6.9)	30.7 (9.2)
1525	2095	90/80	750	1300	1500	490	1430	65	41.5 (6.8)	62.8 (4.5)	53.3 (5.3)
1520	2090	90/80	750	1700	1900	490	1430	65	40.4 (7.0)	62.8 (4.5)	52.3 (5.4)
1555	2125	90/80	750	1700	1900	490	1430	65	37.7 (7.5)	54.3 (5.2)	47.1 (6.0)
1520	2090	90/80	750	1600*	1800*	490	1430	65	39.2 (7.2)	60.1 (4.7)	50.4 (5.6)
1595	2165	90/80	750	1600*	1800*	490	1430	65	35.8 (7.9)	54.3 (5.2)	45.6 (6.2)
1620	2190	90/80	750	1600	1800	490	1430	65	36.7 (7.7)	48.7 (5.8)	43.5 (6.5)
1695	2265	90/80	750	1900	2100	490	1430	64	31.7 (8.9)	50.4 (5.6)	41.5 (6.8)
1695	2265	90/80	750	1900	2100	490	1430	64	31.7 (8.9)	45.6 (6.2)	39.2 (7.2)

³Vehicle's unladen weight without driver (calculated in accordance with the current version of Directive 80/1268/EEC). The fitting of additional equipment may increase the vehicle's unladen weight and drag coefficient, whereupon the potential carrying capacity and top speed will be correspondingly reduced.

⁴The engine's power output always goes down with increasing altitude. At 1,000m above sea level, and for every additional 1,000m, deduct 10% from the weight of the outfit (trailer load limit + gross weight of the towing vehicle).

Dimensions

A4 Saloon

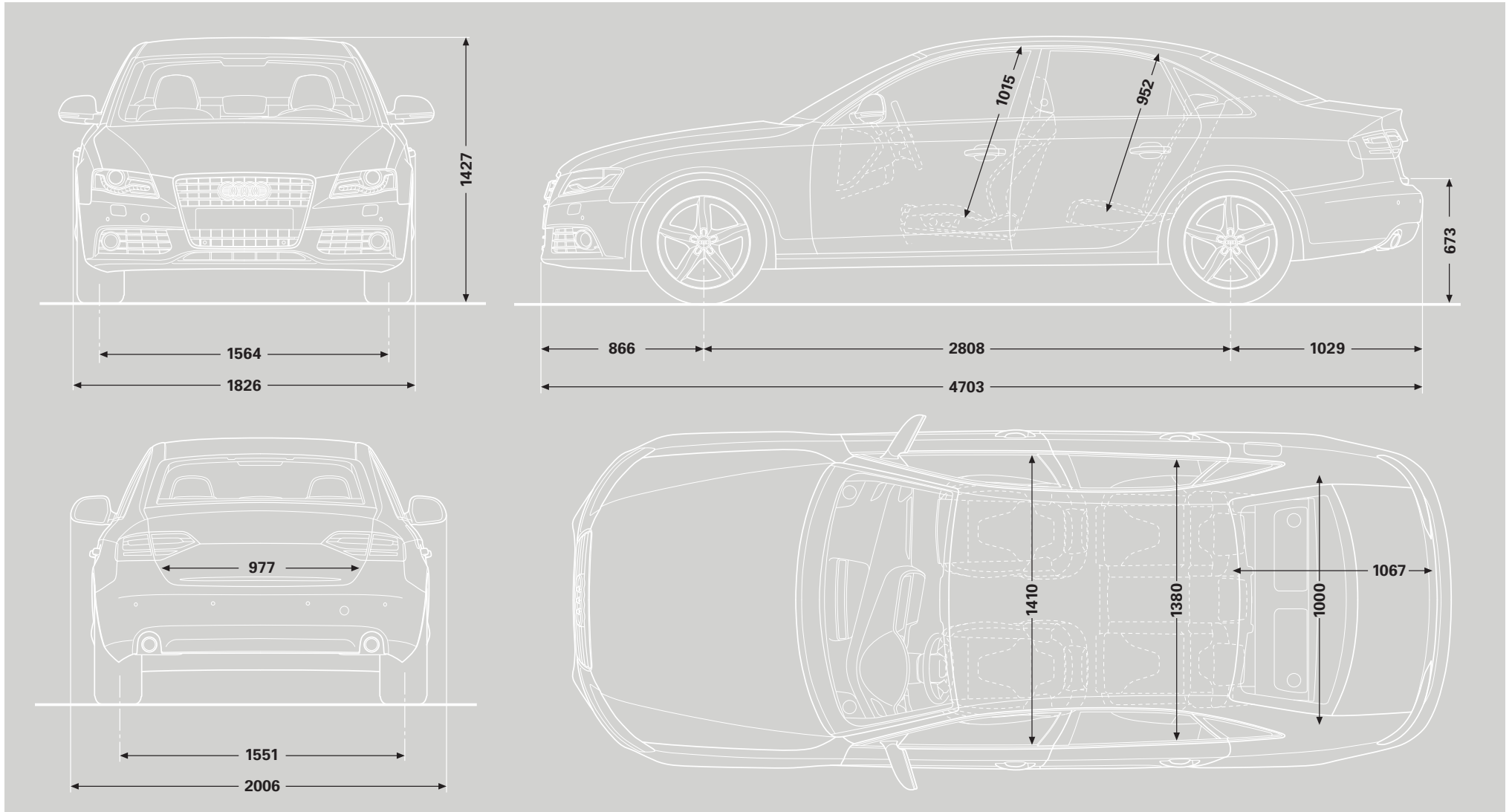

A4 Avant

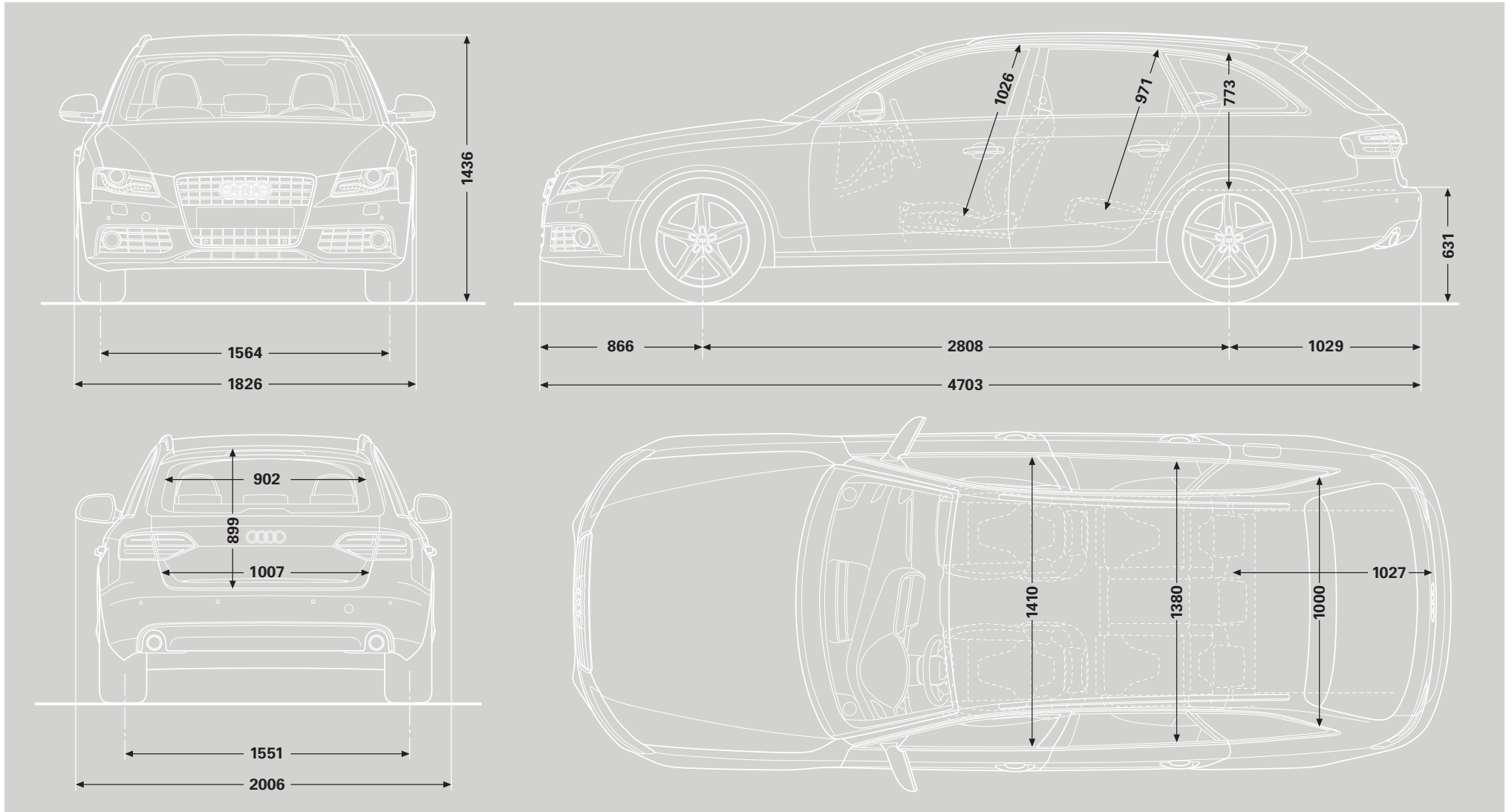

Dimensions were measured with vehicle at unladen weight, ground clearance measured with vehicle carrying its maximum load. Luggage compartment volume in litres: 490/1430 (measured by the VDA standard test method using 200 x 100 x 50mm blocks; second value: with rear seat folded down). Turning circle approx 11.4m

Dimensions in millimetres

Other information

CO2 data and information

CO2 emissions-based Vehicle Excise Duty

Vehicle Excise Duty (Road Fund Licence) is based upon the amount of Carbon Dioxide (CO2) a vehicle emits, measured in grams per kilometre (g/km). The DVLA has created seven categories:

Petrol and Diesel engines	
A – up to 100g/km	£0.00
B – 101 to 120g/km	£35.00
C – 121 to 150g/km	£120.00
D – 151 to 165g/km	£145.00
E – 166 to 185g/km	£170.00
F – 186 to 225g/km	£210.00
G – over 225g/km	£400.00

CO2 emission figures

The CO2 emission figures quoted in the technical data section on pages 44-47 are based on a fully-laden vehicle, including the driver, and the heaviest possible options configuration. Actual CO2 emissions may be lower depending on options selected.

Servicing

Servicing tailored to your needs

With the introduction of model year 2008 TT, A3, A4 and A5 (other models to follow) an improved variable maintenance concept with a revised and simplified maintenance schedule has been introduced to meet the increasingly varied needs of Audi drivers.

As with the original LongLife Servicing there is still the ability to opt for the traditional Fixed Interval Inspection servicing with oil changes every 10,000 miles or the new enhanced servicing concept.

With this new regime the oil change remains variable and, depending on operating conditions, can be carried out up to 20,000 miles or 2 years.

Enhanced LongLife Servicing

Fixed Service intervals:	
Oil-change Service	Every 10,000* miles/1 year
Interval Service	Every 20,000* miles/2 years
Interval Service Inspection	Every 40,000* miles/4 years

However, with enhanced LongLife Servicing, the Inspection Service elements are separate to oil changing. These are carried out for the first time at 3 years or 20,000 miles and then every 2 years/20,000 miles thereafter.

The time and distance remaining until each part of the service is required is displayed separately via the Service Display on the car's computer.

In practice, this new service concept results in lower ownership costs, as maintenance work is carried out when your vehicle really needs it.

Variable Service intervals:	
Interval Service	Flexible to a maximum 20,000* miles/2 years
Interval Service Inspection	Every 20,000* miles/3 years, then every 20,000 miles/2 years thereafter

*Mileages are approximate as the Service Indicator system uses kilometres as its distance measurement.

Service by Design

At Audi, we believe our customers have the right to expect excellent service each and every time they make contact with us. To ensure that this happens, we have agreed a set of service standards with our Audi Centre network that governs the way they do business with you. These standards apply to both Sales and Aftersales, and we actively monitor our Centres to ensure that you receive the highest level of customer service. These service standards will ensure a consistent, stress-free experience whenever you are in contact with anyone representing the Audi brand.

Every Audi Centre will be open during the following hours:

Sales: 9am-6pm Monday to Friday

9am-5pm Saturday

Service: 8am-6pm Monday to Friday

8.30am-1pm Saturday

Sunday opening at local discretion.

Test drives

Whilst we cannot always have the desired demonstrator car ready immediately, we will confirm arrangements for a test drive within two working days (subject to status).

New Car delivery

Once we have confirmed a delivery date with you, we will keep you informed of progress. In the unlikely event of a delay, we will provide you with a courtesy car to minimise inconvenience and keep you mobile.

Delivery to any location within the UK

To maximise your Audi experience right from the first day of ownership, we will deliver your car to your preferred location – whether that's home or your place of work (subject to reasonable notice).

Every attention to detail

Your ownership experience starts with half a tank of fuel.

Quotation response

We are committed to answering any quotation request within 1 working day.

Training

We run a continuous training development programme for all our staff so that we consistently deliver a high-quality, professional service.

Formal complaints procedure

We have a complaints procedure designed to ensure any negative issue you raise with us is dealt with properly.

Service bookings

If you do not require a courtesy car, we will service your Audi within a maximum of 5 working days. If you do choose to take a courtesy car, we will promise to service your vehicle within a maximum of 10 working days.

Cleaning

When your car comes to our workshop, we will wash and vacuum it at no extra cost.

No hidden charges

You will be consulted before we carry out any necessary work on your vehicle, and anything charged for will be itemised on your bill. No extra work will be undertaken without your permission.

A personal service

All work will be done by a named Audi Technician, to whom you can personally direct questions or requests should you need to.

Environmental commitment

We promise to dispose of all non-biodegradable materials from your vehicle in a responsible manner.



Pricing information

Pricing

Prices and specifications given are correct at the time of printing. Always check details with your Audi Centre, as Audi policies are continually developing. We reserve the right to change prices or specifications at any time.

All prices are subject to VAT, currently charged at 17.5%.

Delivery charges and number plates are not included in the vehicle price.

<u>Delivery charge</u>	<u>£469.36</u>
<u>Number plates</u>	<u>£20.00</u>
<u>VAT</u>	<u>£85.64</u>
<u>Total</u>	<u>£575.00</u>

Audi Roadside Assistance

Your new car comes complete with complimentary roadside assistance and recovery across the UK provided by RAC Motoring Services. Also included is roadside assistance throughout Europe, managed by RAC Motoring Services.

Audi Customer Care

Every new Audi benefits from the comprehensive Audi Customer Care Package, which comprises:

- ▶ A 3-year Audi warranty, which covers you for unlimited mileage in the first 2 years of ownership, with a full mechanical and electrical warranty which covers you for up to 60,000 miles in the third year
- ▶ A 3-year paint warranty
- ▶ A 12-year anti-corrosion warranty
- ▶ Up to 3 years' UK roadside assistance and recovery

This package, together with Audi variable Service intervals, offers a combination unmatched by any other major manufacturer. Contact your Audi Centre for full details.

Audi Tax-Free Sales

If you are entitled to purchase a vehicle free of VAT, normally through Military or Diplomatic privilege, please contact your local Audi Centre for full details.

Should you have any difficulty obtaining the information you require, please call Freephone 0800 585878.

Audi Finance

Audi Finance specialise in providing funding solutions for Audi drivers. Whether your Audi is for private or business use, there are a range of funding options to choose from.

Below is the full range of finance products.

- ▶ Solutions – a Personal Contract Plan
- ▶ Hire Purchase
- ▶ Lease Purchase
- ▶ Finance Lease
- ▶ Contract Hire

With all products, you can choose a fixed-cost maintenance plan designed to help you budget accurately.

No matter what Audi model you choose, your local Audi Centre can provide you with a personalised quote which could fit your budget and motoring needs.

Audi Finance is a trading name of Volkswagen Financial Services (UK) Limited. An offer of finance depends on certain conditions. Available to people over 18 in the UK only.

Audi Insurance

Competitive comprehensive motor insurance designed specially for Audi drivers. All new Audi models come with complimentary seven-day cover upon request – we'll email a cover note directly to your Audi Centre, enabling them to tax your car easily. This way, you can drive straight out of the showroom. Taking out an annual policy is easy and can begin as soon as your free seven-day cover expires.

For more information, contact your local Audi Centre. Alternatively, call 0800 051 3146 for a quote and to receive 7 days' complimentary cover for your new Audi.

Audi Insurance is underwritten and administered by Zurich Insurance Company.

Audi UK

Customer Services
Selectapost 29
Sheffield
S97 3FG
0800 699888
www.audi.co.uk

Specifications and
prices subject to
change without notice.

© Audi (UK)

Printed in the UK
Edition 4. 07/08
2009 Model Year



Mixed Sources
Product group from well-managed
forests and other controlled sources

Cert no. TT-COC-002327
www.fsc.org
© 1996 Forest Stewardship Council