

The Audi A5 and S5
Pricing and Specification Guide
Valid from July 2008



A User's Guide

This guide has been designed to help you tailor and price your chosen A5 quickly and logically. At the back of this guide, you will also find information on CO₂ emissions-based taxation and the other services offered by Audi, including Finance and Insurance. If you wish, you can also go to audi.co.uk and configure your A5 online.

Table of content

	Page Number
Introduction	
The A5	
Engines and quattro	6
Model details and prices	
Standard models	8
Sport models	10
S5	12
Transmission	14
Colour and upholstery	
Paint finishes	16
Upholstery options	18
Colour and trim guide	22
Inlays	24
Options	
Wheels, tyres and suspension	26
Audio and communication	28
Safety and security	30
Interior equipment	32
Exterior equipment	32
Seats	34
Audi exclusive	
Audi exclusive options	36
Audi exclusive line	42
Technical details	
Technical data	44
Dimensions	46
Additional information	48

The A5

With the proportions of a classic coupè, the sport-styled A5 is one of the most impressive pioneering designs to date. Sculptured bodywork and aerodynamic lines create a powerful impression of athleticism, reinforced as your eyes follow the trim around muscular wheel arches and along the innovative stretched bonnet design.

This dynamic exterior is more than matched by a host of prestigious interior features. The harmonious lines and understated leather upholstery emphasise the driver's area while retaining its athletic profile. The precise instrument cluster is fully integrated into the dashboard, while the door controls, trim, armrest and storage compartment combine in a single, effective unit.



Petrol

All A5 petrol engines feature FSI® direct-injection – a unique Audi technology originally developed for the Le Mans 24-hour endurance race to deliver increased power and torque as well as enhanced fuel efficiency. The way it does this is, in theory, very simple. Precisely the right amount of fuel and air are injected directly into the combustion chambers, enabling the engine to 'breathe' more easily. At the same time, electronics monitor the engine load and adjust the injection process. The result – reduced heat-loss and increased output, with around a 15% reduction in fuel consumption and significantly lower exhaust emissions. Ideal for the buyer who wants an athletic, exhilarating drive without the drawbacks of excessive fuel costs or high emissions.

Diesel

All diesel engines from Audi are known as TDI. This impressive technology was originally pioneered by Audi in 1989, marking a departure from the noisy, fuel-thirsty diesel engines of the past. Like its FSI petrol counterpart, the TDI diesel engine is designed for power, performance, low fuel consumption and emissions.

All A5 TDI engines are based on the common rail system. Here, fuel is stored and kept at constant pressures of up to 1,600 bar, ready to feed a series of highly accurate piezo injectors, which control the rate and point of injection.



quattro®

It's the technology that has given Audi the edge on the racetrack ever since it was first introduced over 25 years ago – a technology that delivers ultimate control whilst enhancing the athletic characteristics which make the A5 so thrilling to drive. It's called quattro permanent four-wheel-drive. The principle is simple: in the same way that four brakes ensure better deceleration, four permanently-driven wheels deliver better acceleration and road-holding, pushing or pulling the car as needed, for a driving experience that's both dynamic and safe. In the A5 and S5, asymmetric-dynamic torque distribution continuously distributes drive power between the front and rear axles depending on weather conditions, road surface and gradient, which increases flexibility for an enhanced, more dynamic drive.



Standard model equipment

All A5 models have the following items of standard equipment:

Wheels, tyres and suspension

17 x 7.5J '7-spoke' design alloy wheels with 225/50 R17 tyres and locking wheel bolts

Space-saver spare wheel

Audio and communication

Audi Concert radio – CD player with MP3 compatibility, 6.5" colour centre console screen, SD memory card reader and AUX-IN socket in centre console

10 high-performance loud speakers (180 Watts) and 6-channel amplifier

Safety and security

Anti-theft device – Thatcham Category 1 approved

Automatic headlight operation

Automatic windscreen wipers

Door mirrors – electrically operated and heated

Electromechanical parking brake

First aid kit

Front and rear fog lights

Front and rear ISOFIX seats with front passenger airbag de-activation switch

Rear acoustic parking system

Toolkit and car jack

Warning triangle

Xenon headlights including LED daytime-driving lights, headlight washer system and automatic range adjustment (6-cylinder and above models only)

Interior equipment

3-spoke Sports multi-function leather steering wheel with paddle shift for auto-transmission

Deluxe 3-zone climate control with separate air distribution and digital temperature displays for the driver, front passenger and rear passenger compartment

Driver's Information System in colour

Electric front windows

Front and rear floor mats

Front centre armrest

Inlays in Micrometallic platinum

servotronic speed-related power-assisted steering (on 190PS models and above)

Seats

Four seats

Milano leather upholstery

Split-folding rear seat

Exterior Equipment

Aluminium window trims framing the exterior side windows

Auto-opening boot lid

Exhaust pipes – 4-cylinder models have two exhaust pipes on the left hand side and 6-cylinder models have one exhaust pipe on each side

High-gloss black painted grille on 3.0 TDI and 3.2 FSI. All other models come with a Stone grey finish grille



17 x 7.5J '7-spoke' design alloy wheels



Split-folding rear seat – standard

Standard model prices

Petrol

Engines	Power	Transmission	Basic RRP	Total RRP ^{inc. VAT}	Recommended OTR
1.8 TFSI	170PS	6-speed manual	£21,902.12	£25,735.00	£26,535.00
2.0 TFSI	180PS	6-speed manual	£22,072.34	£25,935.00	£26,710.00
2.0 TFSI	211PS	6-speed manual	£23,817.02	£27,985.00	£28,760.00
2.0 TFSI quattro	211PS	6-speed manual	£25,093.62	£29,485.00	£30,285.00
3.2 FSI	265PS	multitronic®	£27,859.57	£32,735.00	£33,575.00
3.2 FSI quattro	265PS	6-speed manual	£27,902.13	£32,785.00	£33,625.00

Diesel

Engines	Power	Transmission	Basic RRP	Total RRP ^{inc. VAT}	Recommended OTR
2.7 TDI	190PS	multitronic®	£26,540.42	£31,185.00	£31,985.00
3.0 TDI quattro	240PS	6-speed manual	£28,029.79	£32,935.00	£33,735.00



Recommended On-The-Road (OTR) retail prices include: delivery charge, half a tank of fuel, numberplates at £575.00 (inc. VAT) and Road Fund Licence (which may vary depending on model. See page 48 for details) and first registration fee at £55.00.

RRP – Recommended Retail Price.

Sport model equipment

In addition to Standard model equipment:

Wheels, tyres and suspension

18 x 8.5J '10-spoke V' design alloy wheels with 245/40 R18 Y tyres

Sports suspension. 20mm lower ride height with stiffer spring settings and shock-absorbers

Seats

Sports seats



Sport model prices

Petrol

Engines	Power	Transmission	Basic RRP	Total RRP ^{inc. VAT}	Recommended OTR
1.8 TFSI	170PS	6-speed manual	£22,710.64	£26,685.00	£27,485.00
2.0 TFSI	180PS	6-speed manual	£22,880.85	£26,885.00	£27,660.00
2.0 TFSI	211PS	6-speed manual	£24,625.53	£28,935.00	£29,710.00
2.0 TFSI quattro	211PS	6-speed manual	£25,902.13	£30,435.00	£31,235.00
3.2 FSI	265PS	multitronic®	£28,668.09	£33,685.00	£34,525.00
3.2 FSI quattro	265PS	6-speed manual	£28,710.64	£33,735.00	£34,575.00

Diesel

Engines	Power	Transmission	Basic RRP	Total RRP ^{inc. VAT}	Recommended OTR
2.7 TDI	190PS	multitronic®	£27,348.93	£32,135.00	£32,935.00
3.0 TDI quattro	240PS	6-speed manual	£28,838.30	£33,885.00	£34,685.00



Recommended On-The-Road (OTR) retail prices include: delivery charge, half a tank of fuel, numberplates at £575.00 (inc. VAT) and Road Fund Licence (which may vary depending on model. See page 48 for details) and first registration fee at £55.00.

RRP – Recommended Retail Price.



S5 quattro model equipment – in addition to Standard models:

One look at its muscular body styling, 19" alloy wheels and subtle V8 badging, and it'll come as no surprise that the Audi S5 features a powerful 4.2-litre V8 engine, capable of taking you from 0 to 62mph in under 6 seconds. And from the comfort and stability of a stylish Silk Nappa leather Sports seat, you can sit back and enjoy every single unit of this engine's 354PS capability, safe in the knowledge that the quattro permanent four-wheel-drive system will keep you exactly where you want to be – on the road.

But sleek styling and powerful performance in the S5 don't come at the expense of functional, driver-oriented specifications. Simple yet thoughtful touches, such as the matt-brushed aluminium inlays, S instrument dials and through-load facility have been included to ensure that your fast-paced life runs as smoothly as your Audi does.

Wheels, tyres and suspension

19 x 8.5J '5-parallel spoke' design alloy wheels with 255/35 R19 tyres

'S' Sports suspension

Safety and security

'S' model enhanced braking system

Interior equipment

3-spoke 'S' Sports multi-function leather steering wheel with silver stitching

Aluminium scuff plates with S5 logo

Interior lighting package

Inlays in matt-brushed aluminium

'S' instrument dials

Aluminium scuff plates with S5 logo

Interior lighting package

Seats

S5 Sports seats with electric adjustment and lumbar support

Silk Nappa leather upholstery

Through-load facility

Exterior equipment

Aluminium-effect door mirror housings

Exhaust pipes – twin on left- and right-hand side in chrome rolled finish

Platinum Grey matt grille, with vertical bars and chrome inserts

Painted brake callipers with S5 logo

'S' body styling



Petrol

Engines	Power	Transmission	Basic RRP	Total RRP <small>inc. VAT</small>	Recommended OTR
S5 quattro	354PS	6-speed manual	£33,391.49	£39,235.00	£40,265.00

Recommended On-The-Road (OTR) retail prices include: delivery charge, half a tank of fuel, numberplates at £575.00 (inc. VAT) and Road Fund Licence (which may vary depending on model. See page 48 for details) and first registration fee at £55.00.

RRP – Recommended Retail Price. Images are for general illustration purposes only and do not necessarily depict UK specification.



Transmission

multitronic®

Translating a driver's preferences and intentions into road performance, the multitronic® automatic transmission system entertains no compromises – whether in terms of dynamism, convenience or economy. multitronic® is available on front-wheel-drive models.

A continuously variable transmission, multitronic® operates in an exceptionally wide range of gear ratios thanks to its steel link-plate chain construction.

The result is exceptional driving comfort, as well as

smooth, powerful acceleration over the entire range of engine speeds. In addition, thanks to its lightweight design and the DRP Dynamic Regulating Programme which monitors gradient, road conditions and the way the driver is using the accelerator pedal, multitronic® also plays an instrumental role in reducing fuel consumption. And with seven simulated gear ratios available, you can enjoy all these benefits whilst adopting the dynamic driving style of a manual.

tiptronic®

The 6-speed tiptronic transmission system is a form of automatic transmission available on A5 models with quattro permanent four-wheel-drive. The technology incorporates DSP – or the Dynamic Shift Programme – which aligns and converts the engine's high power and torque into both athletic performance and operating convenience, with crisp, fast gear changes, reduced weight and optimised gear shifting. In the 'D' (Drive) and 'S' (Sport) programme, the advanced electronics used in tiptronic respond efficiently to every driver input, helping to prevent unwanted gear-changes. The driver can override automatic mode by moving the gear lever into a tiptronic shift-gate, enabling spontaneous gear changing for a more exhilarating driving style.



Transmission

	1.8 TFSI 160PS	2.0 TFSI 180PS	2.0 TFSI 211PS	2.0 TFSI quattro 211PS	3.2 FSI	3.2 FSI quattro	2.7 TDI	3.0 TDI quattro	S5 quattro	Basic RRP	Total RRP ^{inc. VAT}
Automatic 7-speed multitronic® transmission	•	•	-	-	S	-	S	-	-	£1,234.04	£1,450.00
Automatic 6-speed tiptronic® transmission	-	-	-	-	-	•	-	•	•	£1,191.49	£1,400.00

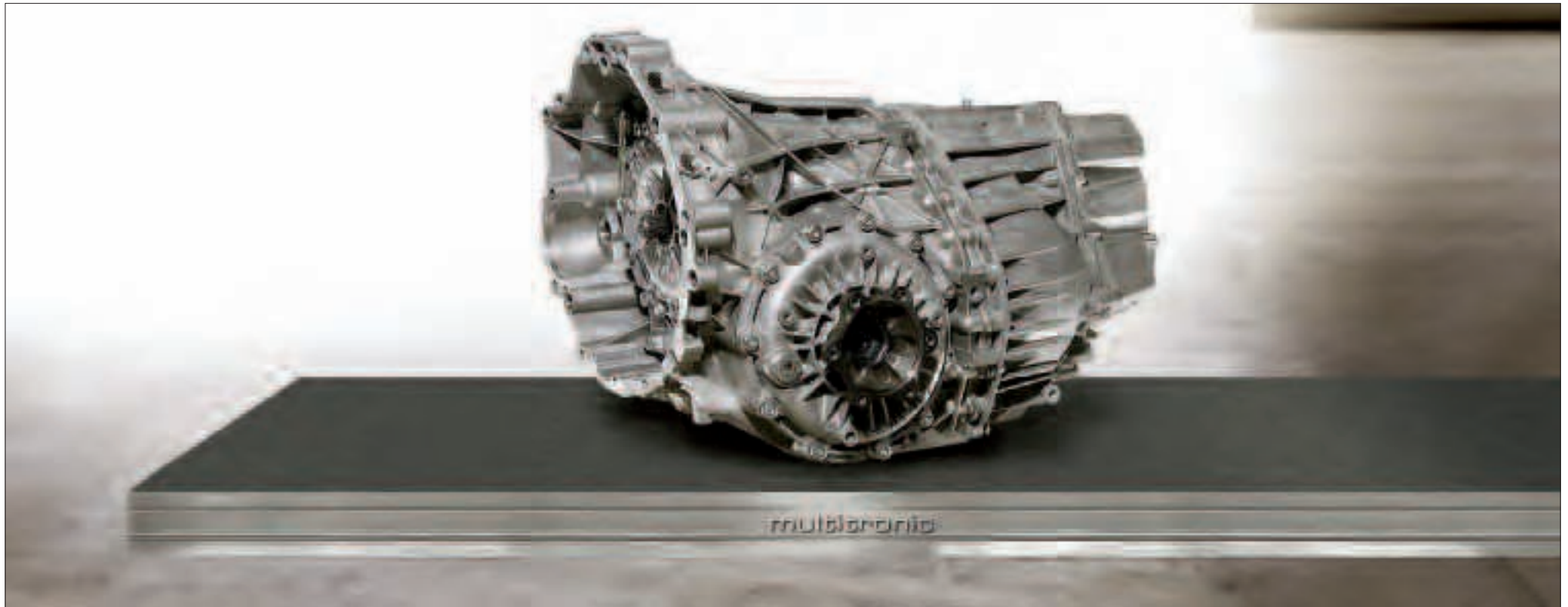

- = Not available

S = Standard

• = Optional

Paint finishes

Standard colours



Brilliant black

A2



Brilliant red

C8

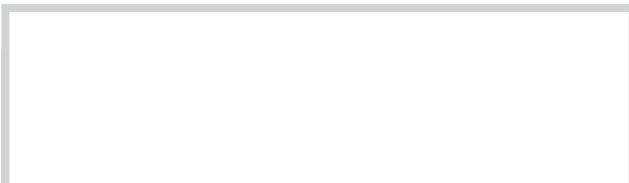

Ibis white

T9

Optional colours

Basic RRP	Total RRP <small>inc. VAT</small>
£510.64	£600.00



Deep Sea blue, pearl effect

8A

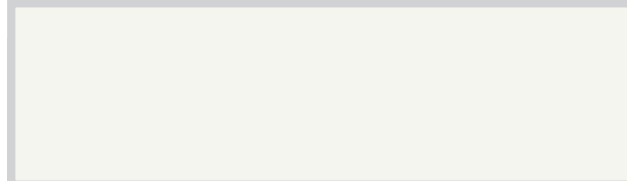

Ice silver, metallic

P5



Phantom black, pearl effect

L8



Garnet red, metallic

9C



Quartz grey, metallic

Q4

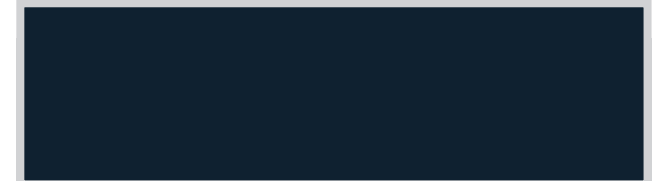

Meteor grey, pearl effect

X5



Sahara silver, metallic – not available on S5 quattro

9T

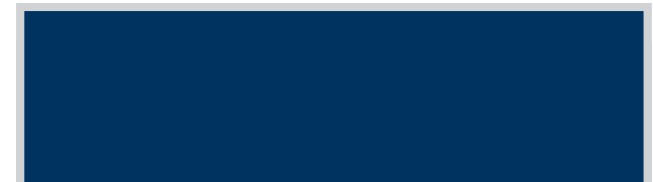

Aruba blue, pearl effect – not available on S5 quattro

Q9



Topaz blue, pearl effect – not available on S5 quattro

T6

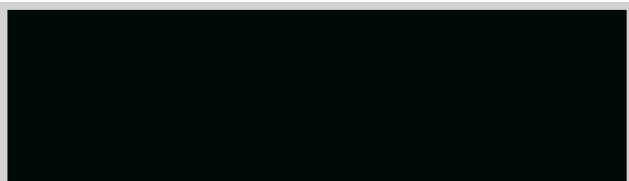

Deep green, pearl effect – not available on S5 quattro

3W



Sprint blue, pearl effect – only available on S5 quattro

5N



A5 Upholstery







Standard seats

								Standard	Sport	S5	Basic RRP	Total RRP ^{inc. VAT}
								S	-	-	No charge	No charge
Milano leather, Black	GD	Milano leather, Light grey	GE	Milano leather, Linen beige	GF	Milano leather, Cinnamon	GJ					
								•	-	-	£297.87	£350.00
Valcona leather, Black	GD	Valcona leather, Light grey	GE	Valcona leather, Linen beige	GF	Valcona leather, Star silver	GK					

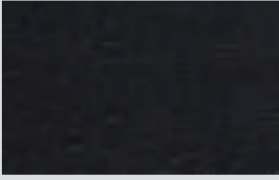

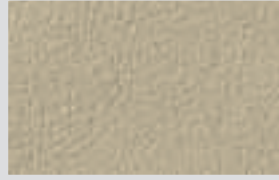
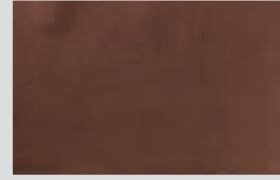
Sports seats in Valcona leather, Star Silver (GK)

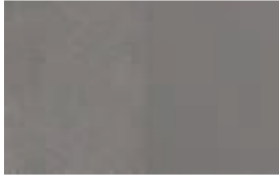
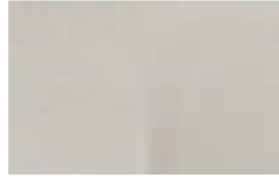
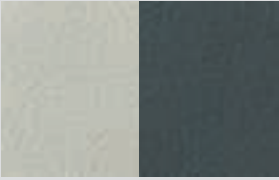
Sports seats

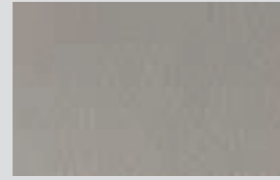
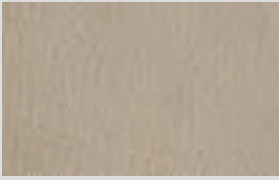
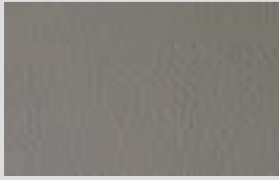
				Standard	Sport	SS	Basic RRP	Total RRP ^{inc. VAT}
				•	S	-	£404.26	£475.00
Milano leather, Black GD	Milano leather, Light grey GE	Milano leather, Linen beige GF	Milano leather, Cinnamon GJ					
				• -	- •	- -	£404.26 No charge	£475.00 No charge
Leather/Alcantara, Black GD	Leather/Alcantara, Light grey GE	Leather/Alcantara, Star silver GK						
				• -	- •	- -	£702.13 £297.87	£825.00 £350.00
Valcona leather, Star silver/Stone blue GG/GL	Valcona leather, Cinnamon/Stone blue GH	Valcona leather, Black GD	Valcona leather, Light grey GE					
								
Valcona leather, Linen beige GF	Valcona leather, Star silver GK							

S5 quattro Sports seats (S5 embossed)

				Standard	Sport	S5	Basic RRP	Total RRP ^{inc. VAT}
				-	-	S	No charge	No charge
Silk Nappa leather, Black	ZM/SC	Silk Nappa leather, Magma red	TR/SF	Silk Nappa leather, Mustang brown	SG/JZ	Silk Nappa leather, Pearl silver	SB/SE	

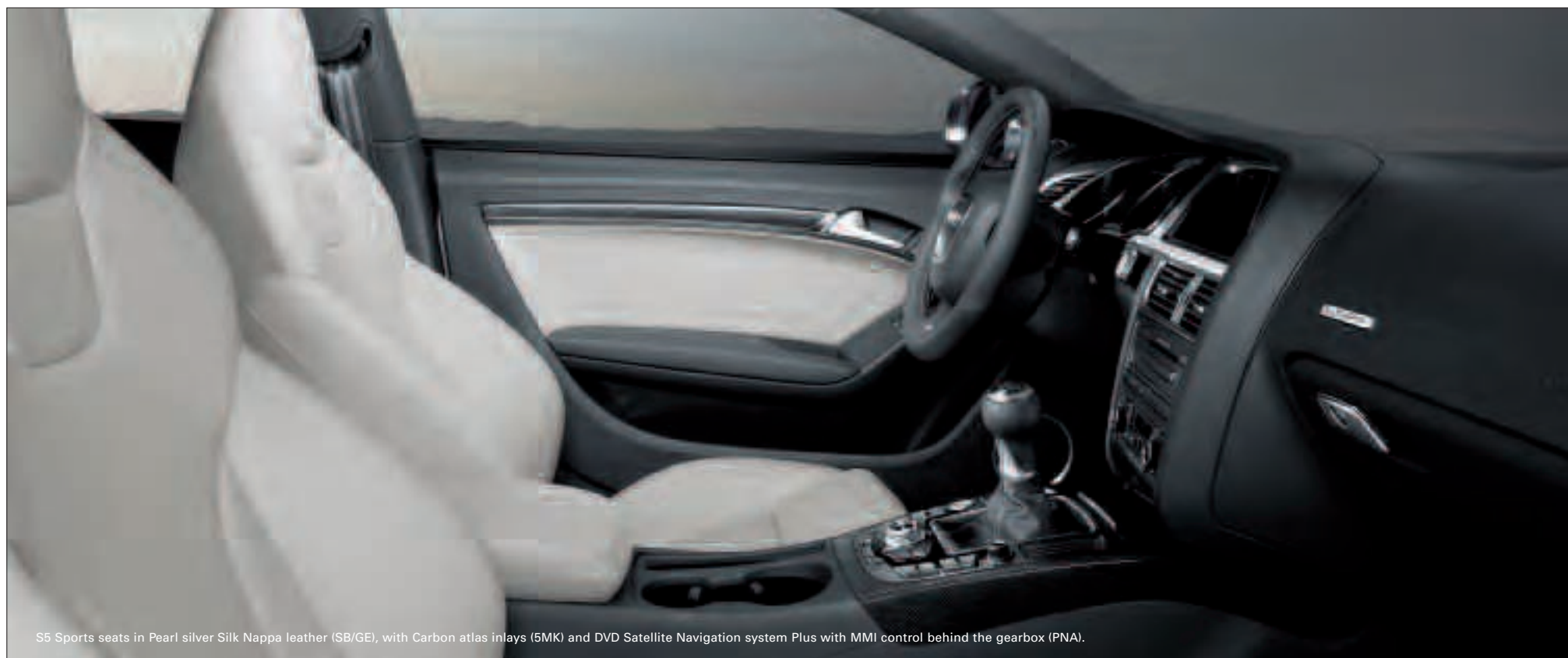



Sports seats in Star silver (GK) Valcona leather and micrometallic platinum inlays.

Colour and trim guide

To help you choose the right interior for your Audi A5, please use the guide below showing the carpet, dashboard and headlining colours that have been matched to your chosen upholstery.

Standard seats – Interior trim colours:

Order code	Upholstery	Carpet	Dashboard	Headlining	Milano leather (N5W)	Valcona leather (N5D)
GD	Black	Black	Black	Star silver	●	●
GE	Light grey	Quartz grey	Black/Graphite grey	Star silver	●	●
GK	Star silver	Quartz grey	Black/Graphite grey	Star silver	–	●
GF	Linen beige	Coriander beige	Taupe beige/Tan beige	Linen beige	●	●
GJ	Cinnamon	Black	Black	Black	●	–

Sports seats – Interior trim colours:

Order code	Upholstery	Carpet	Dashboard	Headlining	Leather/Alcantara (N7U)	Milano leather (N5W)	Valcona leather (N5D)
GD	Black	Black	Black	Star silver	●	●	●
GG	Star silver/Stone blue	Stone blue	Black	Star silver	–	–	●
GH	Cinnamon/Stone blue	Stone blue	Black	Star silver	–	–	●
GE	Light grey	Quartz grey	Black/Graphite grey	Star silver	●	●	●
GK	Star silver	Quartz grey	Black/Graphite grey	Star silver	●	–	●
GL	Star silver/Stone blue	Quartz grey	Black/Graphite grey	Star silver	–	–	●
GF	Linen beige	Coriander beige	Taupe beige/Tan beige	Linen beige	–	●	●
GJ	Cinnamon	Black	Black	Black	–	●	–

S5 quattro Sports seats – Interior trim colours:

Order code	Upholstery	Carpet	Dashboard	Headlining	Silk Nappa leather (N1U)
JZ or SG	Mustang brown	Black	Black	Black or Silver	●
SB or SE	Pearl silver	Black	Black	Black or Silver	●
TR or SF	Magma red	Black	Black	Black or Silver	●
ZM or SC	Black	Black	Black	Black or Silver	●

Options are subject to availability and may extend delivery.
 – = Not available ● = Available





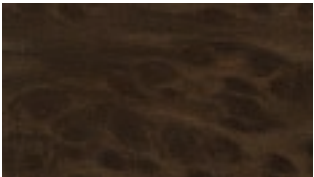
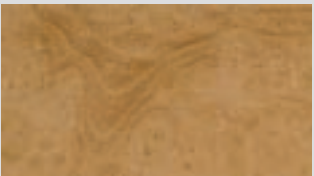

Sports seats in Pearl silver Silk Nappa leather (SB/GE) with matt brushed aluminium inlays (5TG) and Audi concert radio.

Inlays

Order code			Standard	Sport	S5 quattro	Basic RRP	Total RRP ^{inc. VAT}
5MA		Micrometallic platinum	S	S	-	No charge	No charge
5TG		Matt-brushed aluminium	-	-	S	No charge	No charge
5TE		Aluminium hologram	•	•	-	£127.66	£150.00
5TW		Vavona wood, Assam grey	-	-	•	£148.94	£175.00
5TK		Fine grain ash, Almond beige	•	•	-	£276.60	£325.00

Inlays

Order code			Standard	Sport	S5 quattro	Basic RRP	Total RRP ^{inc. VAT}
5MG		Walnut brown	•	•	-	£276.60	£325.00
5MZ		Stainless steel mesh (centre console comes in Piano black)	-	-	•	£297.87	£350.00
5MK		Carbon atlas	-	-	•	£212.77	£250.00
7TD		Laurel nutmeg	•	•	-	£276.60	£325.00

Wheels, tyres and suspension

Order code		Standard	Sport	S5 quattro	Basic RRP	Total RRP <small>inc. VAT</small>
PRS	17 x 8J '6-arm' design alloy wheels with 245/45 R17 Y tyres	•	-	-	£127.66	£150.00
PRC	18 x 8.5J '10-spoke V' design alloy wheels with 245/40 R18 Y tyres	•	S	-	£553.19	£650.00
PRV	19 x 8.5J '5-spoke Y' design alloy wheels with 255/35 R19 Y tyres	• -	- •	- -	£1,106.38 £553.19	£1,300.00 £650.00
PQS	19 x 9J '20-spoke' design, 2 piece alloy wheels with 255/35 R19 Y tyres	• -	- •	- -	£1,191.49 £638.30	£1,400.00 £750.00
PQF	20 x 9J '7-arm double spoke' design alloy wheels with 255/30 R20 tyres (cannot be combined with Audi drive select with Damper Control or Audi drive select full package)	- -	• -	- •	£1,319.15 £936.17	£1,550.00 £1,100.00



17 x 8J '6-arm' design alloy wheels



18 x 8.5J '10-spoke V' design alloy wheels



19 x 8.5J '5-spoke Y' design alloy wheels

Wheels, tyres and suspension

Order code		Standard	Sport	S5 quattro	Basic RRP	Total RRP <small>inc. VAT</small>
1BE	Sports suspension. 20mm lower ride height with stiffer spring settings and shock-absorbers	•	S	-	£212.77	£250.00
2H1+1N7	Audi drive select – with Dynamic Steering (6-cylinder models only)	-	•	•	£851.06	£1,000.00
2H1+1BL	Audi drive select – with Damper Control (m/h servotronic)	-	•	•	£851.06	£1,000.00
2H1+1BL +1N7	Audi drive select – full package (6-cylinder models only)	-	•	•	£1,446.81	£1,700.00



19 x 9J '20-spoke' design alloy wheels



20 x 9J '7-arm double spoke' design alloy wheels



Audi drive select – full package (6-cylinder models only)

Audio and communication

Order code		Standard	Sport	S5 quattro	Basic RRP	Total RRP <small>inc. VAT</small>
8UM	Audi Symphony Radio , with front-loading MP3-compatible 6-CD changer, 6.5" colour screen and SD memory card reader and AUX-IN socket in centre console	•	•	•	£234.04	£275.00
9VK	Bang & Olufsen sound system , designed specifically for the A5, providing surround-sound reproduction with dynamic noise compensation, 14 high-performance loud speakers (505-Watt) and 10-channel amplifier	•	•	•	£446.81	£525.00
QV3	DAB digital radio	•	•	•	£255.32	£300.00
QV9	TV reception – analogue and digital (only in combination with Satellite Navigation system Plus)	•	•	•	£723.40	£850.00
PT5	Mobile telephone preparation – Low. In front centre armrest, uses Bluetooth interface or cradle to connect to your A5, including roof aerial for optimal reception. Includes centre armrest for Standard trim models. A phone cradle is required for charging your phone, at extra cost. Please see your Audi Centre for phone compatibility. (Only in combination with Concert radio or Symphony radio and multi-function steering wheel)	•	•	•	£319.15	£375.00
9ZW	Mobile telephone preparation – High. Uses Bluetooth interface with no physical connection to your A5, including roof aerial for optimal reception. Please note that your mobile phone must have SIM-Access Profile facility for full functionality. (Only in combination with Satellite Navigation system Plus)	•	•	•	£553.19	£650.00



Bang & Olufsen sound system



Mobile telephone preparation – High with privacy handset

Audio and communication

Order code		Standard	Sport	S5 quattro	Basic RRP	Total RRP ^{inc. VAT}
PT4	Mobile telephone preparation – High (with privacy handset). The handset allows passengers to make private calls, providing remote control of the telephone functions as well as a convenient SMS text messaging function. The handset is charged from a docking station integrated in the front centre armrest. (Only in combination with Satellite Navigation system Plus)	•	•	•	£808.51	£950.00
PNA	Satellite Navigation system Plus. DVD-based route planning and guidance with MMI, radio, 6-CD changer and European-coverage TMC-enabled DVD	•	•	•	£1,680.85	£1,975.00
QH3	Voice Control System, operates key basic functions of Satellite Navigation system Plus, as well as the CD, the radio and the phone (only in combination with Satellite Navigation system Plus)	•	•	•	£276.60	£325.00
7D3	Audi Music Interface. Universal connection for use with stereo audio sources and iPod generation 4 onwards (iPod, iPod mini, iPod nano, iPod photo, iPod video). Provides intuitive control through the audio system and multi-function steering wheel. It also replicates the iPod display on the audio screen, including track titles. The interface provides power as well as a convenient rubberised storage tray. An adapter cable is required at additional cost. Please consult your Audi Centre for details	•	•	•	£170.21	£200.00



MMI – part of Satellite Navigation system Plus



MMI Control – part of Satellite Navigation system Plus

Safety and security

Order code		Standard	Sport	S5 quattro	Basic RRP	Total RRP ^{inc. VAT}
7X4	Audi Parking System Plus , aids parking by acoustically and graphically indicating distances to obstacles in front of and behind your A5	•	•	•	£255.32	£300.00
7X8	Audi Parking System Advanced , aids parking by acoustically and visually indicating distances to obstacles in front of and behind your A5 with guiding lines. Measured by ultrasonic sensors and camera integrated discreetly in the boot handle. Only in combination with Satellite Navigation system Plus	•	•	•	£553.19	£650.00
7Y1	Audi side assist , aids the driver when changing lane. Audi side assist monitors the area behind your A5 using radar sensors located discreetly in the rear bumper, informing the driver via a visual warning signal in the door mirror if there is a vehicle in the driver's blind spot or approaching quickly from behind. The system is activated via a button in the driver's door	•	•	•	£382.98	£450.00
7Y2	Audi lane assist , uses a discreet camera at the top of the windscreen to monitor the road ahead. The driver is warned via a vibration of the steering wheel if the vehicle is about to exit the lane unintentionally	•	•	•	£382.98	£450.00
UH2	Audi hill-hold assist , automatically activates electromechanical parking brake when stationary	•	•	•	£38.30	£45.00
8Q5	Adaptive light . Swivelling headlights for improved illumination of winding roads	•	•	•	£276.60	£325.00
6XE	Door mirrors – electrically-folding	•	•	•	£148.94	£175.00
6XK 4L6 8N6	Door mirrors – electrically-folding and auto-dimming . Includes auto-dimming rear view mirror and light and rain sensors which control the automatic headlights facility, the coming home/leaving home function and the automatic windscreen wipers	•	•	•	£404.26	£475.00
VC1	Garage door opener (HomeLink**) . Programmable radio-operated remote control for compatible doors/gates. Control buttons integrated in the roof module at the front	•	•	•	£148.94	£175.00
7K6	Tyre pressure monitor	•	•	•	£63.83	£75.00

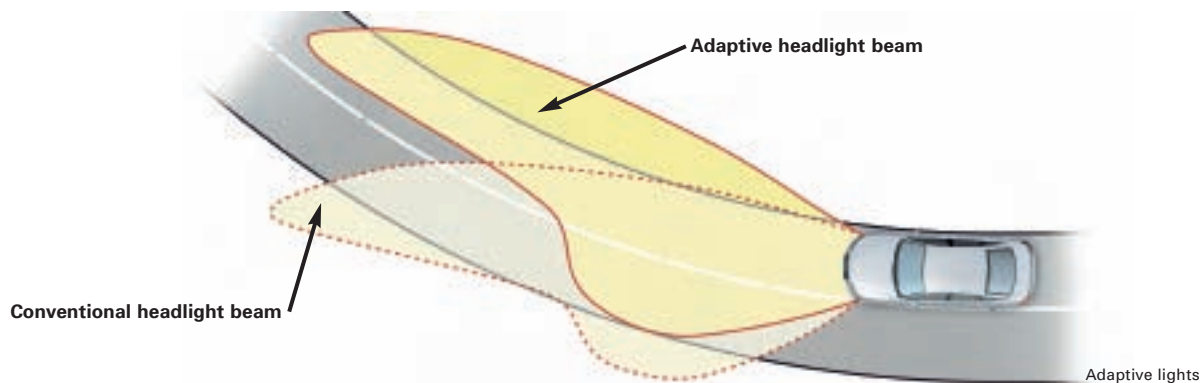



Interior equipment

Order code		Standard	Sport	S5 quattro	Basic RRP	Total RRP ^{inc. VAT}
4K7	Advanced key. Access and authorisation system which automatically exchanges data between key and vehicle, allowing the driver to keep the key in their pocket or bag at all times. To unlock and open, simply lift the exterior door handle. To lock, press the button on the handle. Pressing the start/stop button integrated in the centre console starts and stops the engine	•	•	•	£421.28	£495.00
8T1	Cruise control	•	•	•	£161.70	£190.00
8T4	Adaptive cruise control (ACC) (Only available on 6-cylinder models)	•	•	•	£936.17	£1,100.00
4L6 8N6	Auto-dimming rear-view mirror. Includes light and rain sensors which control the automatic headlights facility, the coming home/leaving home function and the automatic windscreen wipers	•	•	•	£170.21	£200.00
6NQ	Black headlining. Only in combination with GD and GG interiors on A5 models. Available with all interiors as standard on S5	•	•	S	£170.21	£200.00
PKH QE1	Storage pack. Includes storage nets on the back of the front seats, storage compartment under the front seats (only under passenger seat if memory function is fitted), drinks holder in the rear centre armrest and lockable glove compartment. Also includes tie-down straps and 12V socket in the boot	•	•	•	£148.94	£175.00
QQ1	Interior lighting package. Includes rear reading lights, entrance lights, front footwell lights, active door reflectors and illumination to the glove compartment, vents and internal door controls	•	•	S	£85.11	£100.00
3Y2	Electric rear window blind	•	•	•	£191.49	£225.00

Exterior equipment

Order code		Standard	Sport	S5 quattro	Basic RRP	Total RRP ^{inc. VAT}
2Z0	Deletion of model and engine capacity designation at rear	•	•	-	No charge	No charge
2Z7	Deletion of engine capacity designation at rear	•	•	-	No charge	No charge
1D2	Tow bar	•	•	•	£553.19	£650.00
PX4	Xenon Plus headlights and LED daytime-running lights (standard on 6-cylinder and above models)	•	•	S	£659.57	£775.00



Seats

Order code		Standard	Sport	S5 quattro	Basic RRP	Total RRP <small>inc. VAT</small>
PV1	Electric front seats , with adjustment for height, forwards and backwards position, backrest angle and lumbar support for driver and front-passenger seats	•	-	S	£638.30	£750.00
		-	•	-	£510.64	£600.00
PV3	Comfort pack , comprising electric front seats with memory function on driver's side, door mirrors – electrically folding and auto-dimming with memory function, auto-dimming rear view mirror and light and rain sensors which control the automatic headlights, the coming home/leaving home function and the automatic windscreen wipers	•	-	-	£1,191.49	£1,400.00
6XL		-	•	-	£1,063.83	£1,250.00
4L6		-	-	•	£510.64	£600.00
8N6						
4A3	Heated front seats	•	•	•	£212.77	£250.00
4A4	Heated front and outer rear seats	•	•	•	£382.98	£450.00
3X2	Through-load facility , with removable ski bag for transporting long objects	•	•	S	£136.17	£160.00



Electric front seats



Through-load facility



Standard seats in Milano leather cinnamon (GJ) with Walnut brown inlays (5MG).

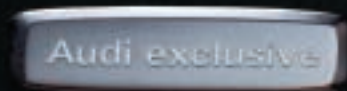

Every Audi is intrinsically exclusive. It's the breathtaking design, the exceptional engineering, the Vorsprung durch Technik. But for that added element of exclusivity – that distinguishing look that sets you apart from the rest – you can specify your A5 with options from Audi exclusive. Whether you want a completely unique, custom-mixed paint colour, seats in a combination of complementary shades or even individualised carpets and floor mats, Audi exclusive will enable you to drive the car you've always imagined.

For more information on any of the options over the following pages or to view swatches, simply ask a member of staff at your local Audi Centre.

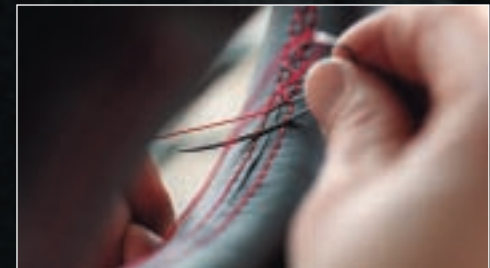

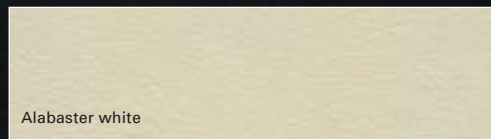

Alabaster white

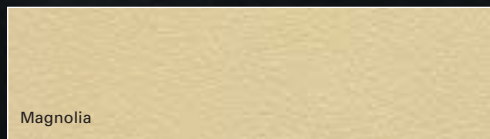

Magnolia

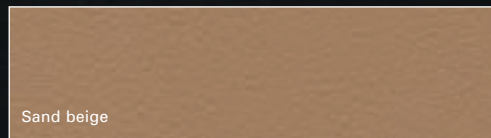

Sand beige

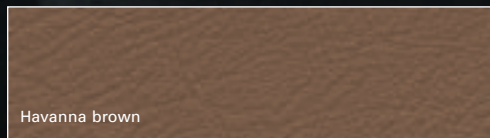

Havana brown

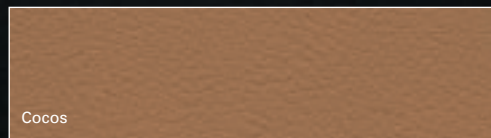

Cocos

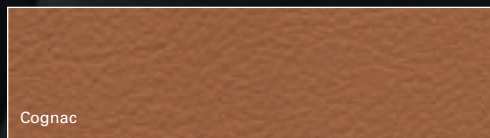

Cognac



Saddle brown

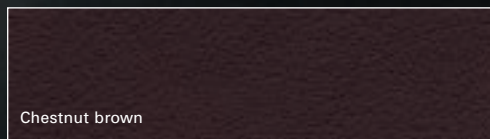

Chestnut brown

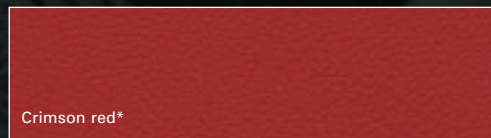

Crimson red*

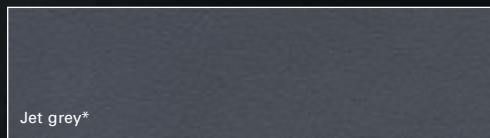

Jet grey*



Palace blue

Upholstery

With Audi exclusive, you can choose between Valcona leather and Alcantara, depending on the texture and flexibility you prefer in your car's upholstery. And once that's decided, you can specify your seats in an array of different colours shown to the left.

Choose just one all-over shade for each seat, or for a more striking look, customise each panel in two or more complementary colours from the distinctive Audi exclusive palette shown here. You can even choose the colour of the decorative stitching – to match or contrast with your chosen upholstery – from this varied collection. Whatever combination you decide upon, you're guaranteed to be extremely comfortable with the result.

	Standard	Sport	SS	Basic RRP	Total RRP ^{inc. VAT}
Valcona leather – seat centre section and door trim inserts	–	•	•	£1,914.89	£2,250.00
Leather/Alcantara – seat centre section and door trim inserts	–	•	•	£1,914.89	£2,250.00
Valcona leather – front and rear seats, door trim inserts, door armrests, head restraints, rear and front centre armrest and back of seat cover	–	•	•	£2,510.64	£2,950.00

*Not available in Alcantara.

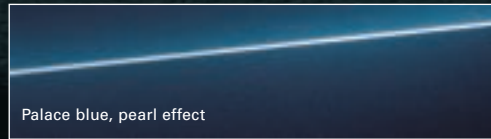

Palace blue, pearl effect

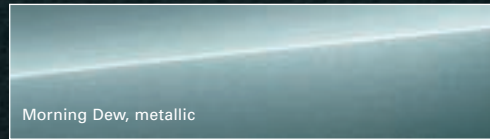

Morning Dew, metallic

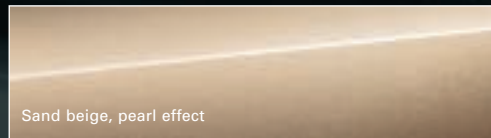

Sand beige, pearl effect

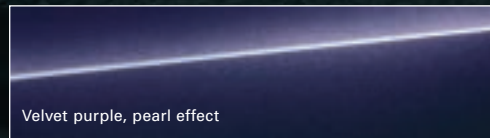

Velvet purple, pearl effect

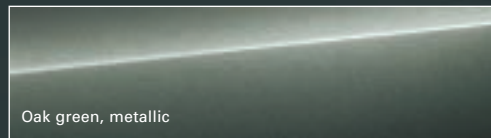

Oak green, metallic

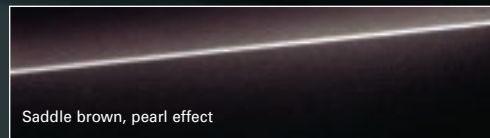

Saddle brown, pearl effect

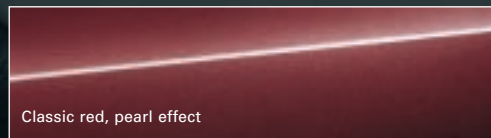

Classic red, pearl effect

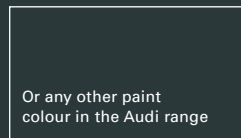

Or any other paint colour in the Audi range

Basic RRP	Total RRP ^{inc.} _{VAT}
£1,446.80	£1,700.00

Paint

Everyone has a favourite colour. No matter what yours is, Audi exclusive provides a range of unique colours that have been designed to set your car apart. Choose from the swatches here, or specify any other paint colour in the Audi range – whether it’s Jet blue from the Audi R8 or Alpine white from the original Audi quattro. The choice is yours.

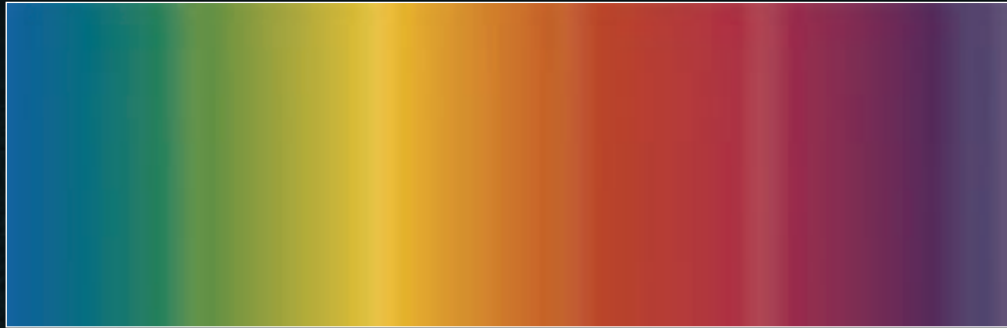

Customised paint

In a car made from Vorsprung durch Technik, there are no compromises. So if you have a particular colour in mind, we'll mix the exact water-based pearlescent or metallic-effect shade you want – whether it's the blue of your favourite shirt or the wall colour in your sitting room.

Basic RRP	Total RRP ^{inc.} _{VAT}
£2,042.55	£2,400.00

Steering wheels and controls pack

Our fingertips and palms contain more touch receptors than any other part of our body – so shouldn't the parts of our car we handle the most also be the most pleasing to touch? With this in mind, Audi exclusive enables you to customise the steering wheel of your choice in smooth, warm leather, in any of the colours shown on page 37. As with Audi exclusive seats, you even have free choice on the colour of the decorative stitching used. Choose a Controls Pack and you can extend this exclusive look and feel to your car's handbrake, gearknob and gaiter too.



	Basic RRP	Total RRP <small>inc. VAT</small>
Steering wheel	£297.87	£350.00
Controls pack	£510.64	£600.00

Carpets and floor mats

Exclusivity isn't just about choice and individuality – it's about attention to every detail in your A5; and for us, that includes the carpets and floor mats. First, choose from ten different colours of high-quality velour carpets. Next, choose the colour of your car's floor mats from the same list, whilst using the palette of Audi upholstery colours detailed on page 37 to select a leather colour for the mats' decorative leather piping – matched or contrasting, depending on your personal taste. Floor mats are included when you order Audi exclusive carpet; but if you wish, they can also be purchased separately in a set of four.

Carpet colours

- ▶ Alabaster white
- ▶ Magnolia
- ▶ Sand beige
- ▶ Havana brown
- ▶ Cocos
- ▶ Cognac
- ▶ Chestnut brown
- ▶ Palace blue
- ▶ Amethyst grey



	Basic RRP	Total RRP ^{inc. VAT}
Carpets	£723.40	£850.00
Floor mats	£255.32	£300.00

Audi exclusive line

Audi exclusive is ultimately about choice – but if you’d rather leave some of the decisions in the capable hands of our designers, the expert team at quattro GmbH have compiled Audi exclusive line, combining some of the most popular elements of the exclusive range in one stylish, beautifully co-ordinated package. The package gives you:

- ▶ Two-tone Valcona leather upholstery. Seat centres in Magnolia or Cognac. Seat-side sections and head restraints in black with decorative stitching to match seat centres
- ▶ Door panels in Valcona leather to match seat centres
- ▶ 3-spoke Sports multi-function steering wheel in black leather and gear lever gaiter with stitching to match seat centres
- ▶ Black front and rear floor mats with leather piping to match seat centres
- ▶ Matt-brushed aluminium inlays
- ▶ Audi exclusive scuff plates
- ▶ Black cloth headlining
- ▶ Black dashboard and carpets

Only in combination with Black headlining (6NO)



	Standard	Sport	S5 quattro	Basic RRP	Total RRP ^{inc. VAT}
Audi exclusive line	-	•	-	£1,021.28	£1,200.00



Magnolia (QQ)



Cognac (QX)

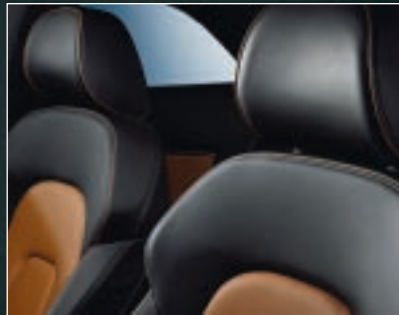

Technical data

A5

Petrol									
Engine	Cylinder	Displacement, cubic cm (valves per cylinder)	Max. power ¹ , PS	Max. torque, Nm	Transmission	CO ₂ emissions ² , g/km	0-62mph acceleration, seconds	Top speed, mph	ABI insurance group
1.8 TFSI	4-cylinder	1798	170	250	6-speed manual	169	8.4	143	14E
1.8 TFSI	4-cylinder	1798	170	250	multitronic®	174	8.6	135	14E
2.0 TFSI	4-cylinder	1984	180	320	6-speed manual	154	7.8	148	TBC
2.0 TFSI	4-cylinder	1984	180	320	multitronic®	167	8.1	140	TBC
2.0 TFSI	4-cylinder	1984	211	350	6-speed manual	154	6.9	155	TBC
2.0 TFSI quattro	4-cylinder	1984	211	350	6-speed manual	173	6.5	153	TBC
3.2 FSI	V6	3197	265	330	multitronic®	199	6.6	155	16E
3.2 FSI quattro	V6	3197	265	330	6-speed manual	213	6.1	155	16E
3.2 FSI quattro	V6	3197	265	330	tiptronic	215	6.4	155	16E
S5 quattro	V8	4163	354	440	6-speed manual	288	5.1	155	19E
S5 quattro	V8	4163	354	440	tiptronic	256	5.4	155	19E

Diesel

2.7 TDI	V6	2698	190	400	multitronic®	167	7.6	144	15E
3.0 TDI quattro	V6	2967	240	500	6-speed manual	172	5.9	155	17E
3.0 TDI quattro	V6	2967	240	500	tiptronic	182	6.1	155	17E

¹ The given value was obtained in accordance with the specified measurement procedure (the respective current version of the Directive 80/1269/EEC).

² The given values were calculated in accordance with the specified measurement procedure (the respective current version of Directive 80/1268/EEC). This information does not relate to a single vehicle and does not comprise part of the offer but is merely intended for the purpose of comparison between the different vehicle types.

³ Vehicle's unladen weight without driver (calculated in accordance with the current version of Directive 80/1268/EEC). The fitting of additional equipment may increase the vehicle's unladen weight and drag coefficient, whereupon the potential carrying capacity and top speed will be correspondingly reduced.

Weights, kg			Max. trailer load ⁴ , kg			Volumes			Fuel consumption, mpg (l/100km)		
Unladen weight ³	Gross weight limit	Roof load limit/nose weight	unbraked	with 12% gradient	with 8% gradient	Luggage compartment capacity, cubic litres		Fuel tank capacity approx, litres	Urban	Extra Urban	Combined
						Rear seats upright	Rear seats folded				
1395	1895	75/80	730	1300	1500	455	829*	65	28.5 (9.9)	51.4 (5.5)	39.8 (7.1)
1435	1935	75/80	750	1500	1300	455	829*	65	27.2 (10.3)	49.6 (5.7)	38.2 (7.4)
1420	TBC	75/80	750	TBC	TBC	455	829*	65	31.4 (9.0)	54.3 (5.2)	42.8 (6.6)
1460	TBC	75/80	750	TBC	TBC	455	829*	65	29.1 (9.7)	50.4 (5.6)	39.8 (7.1)
1420	1920	75/80	750	1500	1700	455	829*	65	31.4 (9.0)	54.3 (5.2)	42.8 (6.6)
1490	1990	75/80	750	1700	1900	455	829*	65	28.2 (10.0)	47.9 (5.9)	38.2 (7.4)
1495	1995	75/80	750	1700	1800	455	829*	65	23.2 (12.2)	45.6 (6.2)	33.6 (8.4)
1535	2035	75/80	750	1900	2100	455	829*	64	21.7 (13.0)	42.8 (6.6)	31.7 (8.9)
1570	2070	75/80	750	1900	2100	455	829*	64	21.7 (13.0)	42.2 (6.7)	31.4 (9.0)
1630	2130	75/80	750	1900	2100	455	829*	63	15.9 (17.8)	30.7 (9.2)	22.8 (12.4)
1675	2175	75/80	750	2100	1900	455	829*	63	18.0 (15.7)	35.8 (7.9)	26.2 (10.8)
1575	2075	75/80	750	1700	1900	455	829*	64	36.2 (7.8)	51.4 (5.5)	44.1 (6.4)
1610	2110	75/80	750	1900	2000	455	829*	64	32.1 (8.8)	53.3 (5.3)	42.8 (6.6)
1650	2150	75/80	750	2100	1900	455	829*	64	32.8 (8.6)	47.9 (5.9)	40.9 (6.9)

⁴The engine's power output always goes down with increasing altitude. At 1000m above sea level, and for every additional 1000m, deduct 10% from the weight of the outfit (trailer load limit + gross weight of the towing vehicle).

* Loaded up to roof with rear seat folded down.

Dimensions

A5

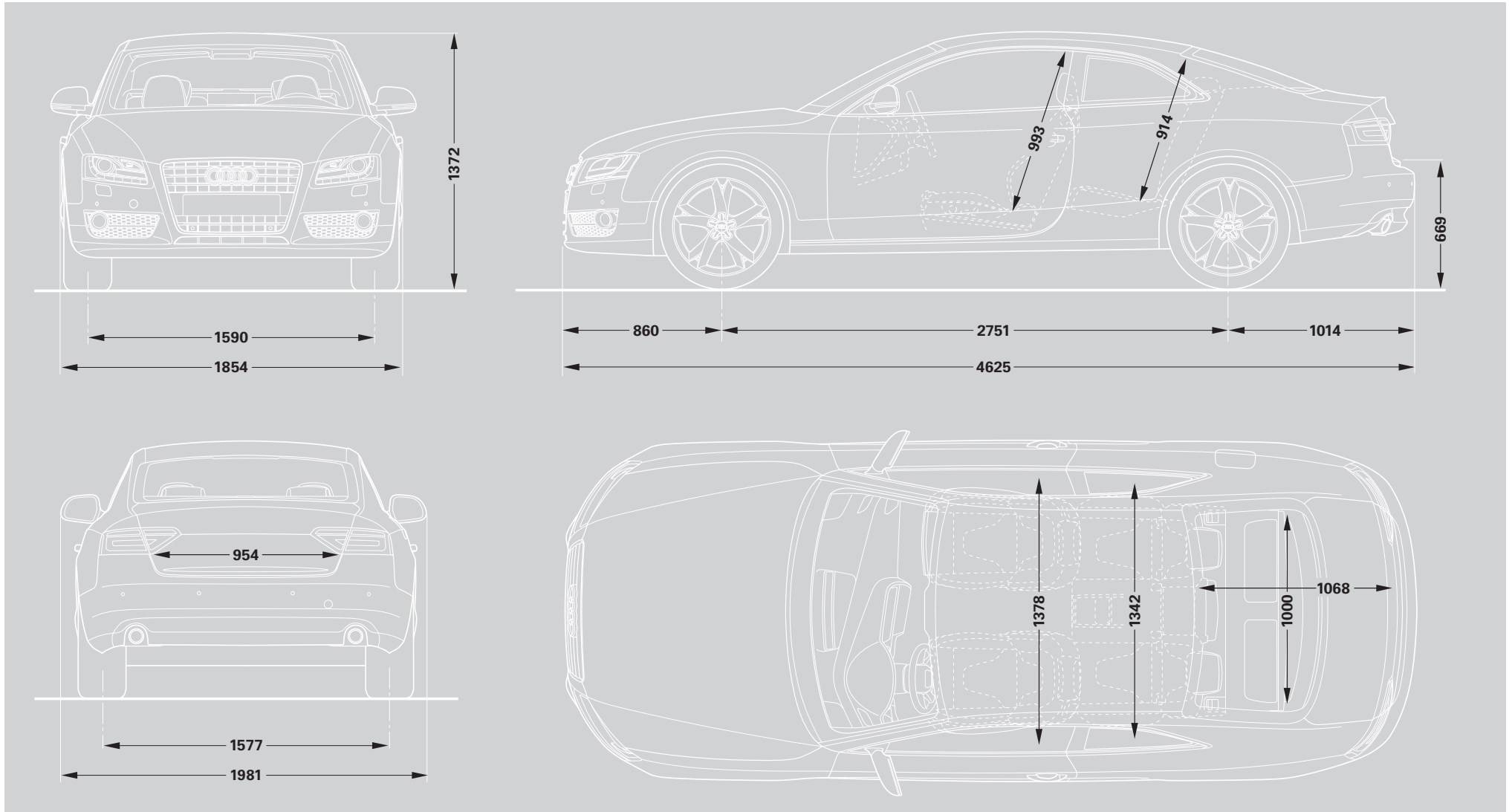

S5 quattro

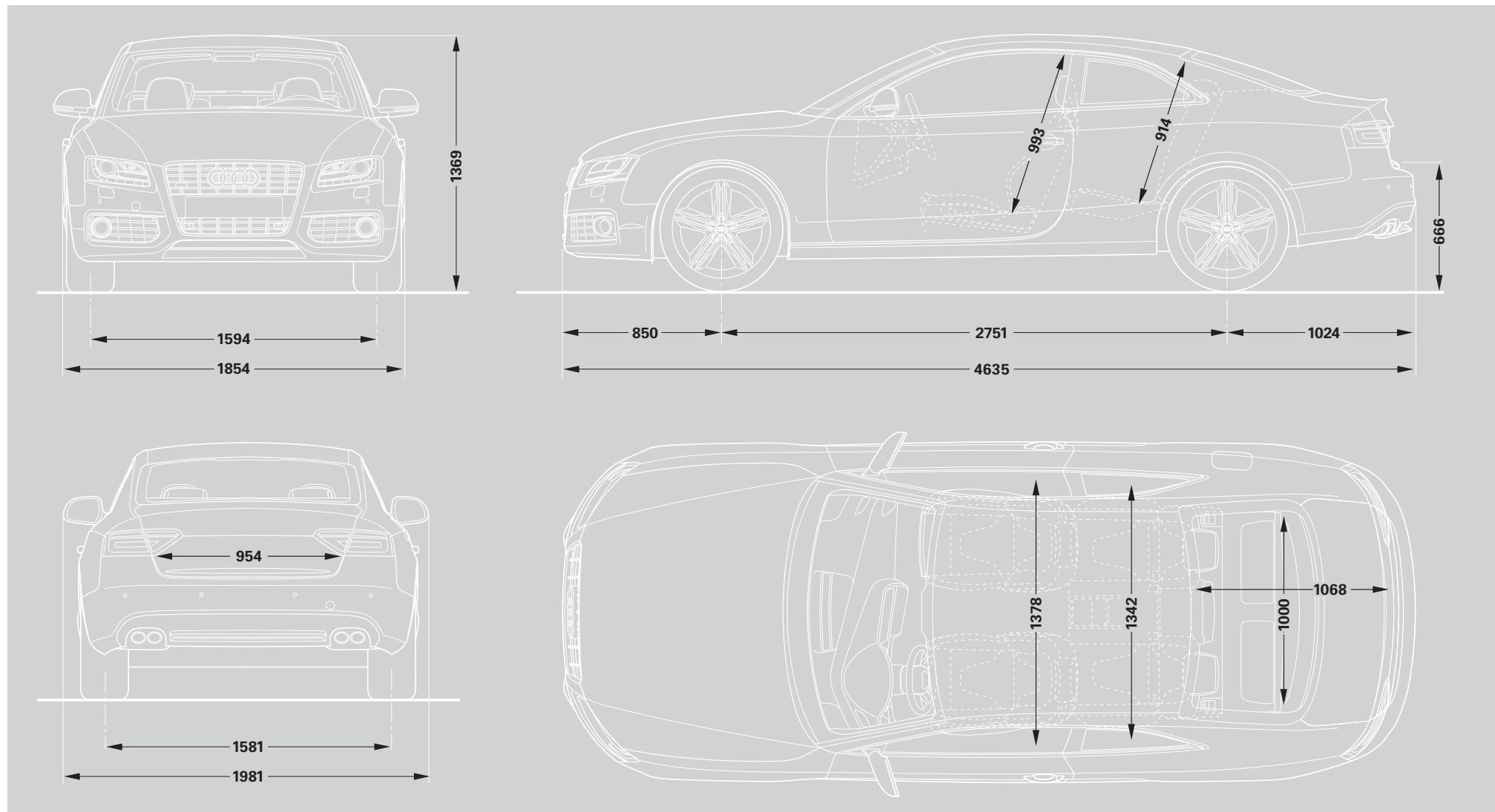

Dimensions were measured with vehicle at unladen weight, ground clearance measured with vehicle carrying its maximum load. Luggage compartment volume in litres: 455/829 (measured by the VDA standard test method using 200 x 100 x 50 mm blocks; second value: with rear seat folded down). Turning circle approx 11.4m

Dimensions in millimetres

Additional information

CO₂ data and information

CO₂ emissions-based Vehicle Excise Duty

Vehicle Excise Duty (Road Fund Licence) is based upon the amount of Carbon Dioxide (CO₂) a vehicle emits, measured in grams per kilometre (g/km). The DVLA has created seven categories:

Petrol and Diesel engines	
A – up to 100g/km	£0.00
B – 101 to 120g/km	£35.00
C – 121 to 150g/km	£120.00
D – 151 to 165g/km	£145.00
E – 166 to 185g/km	£170.00
F – 186 to 225g/km	£210.00
G – over 225g/km	£400.00

CO₂ emission figures

The CO₂ emission figures quoted in the technical data section on page 44 are based on a fully-laden vehicle, including the driver, and the heaviest possible options configuration. Actual CO₂ emissions may be lower depending on options selected.

Servicing

Servicing tailored to your needs

With the introduction of model year 2008 TT, A3 and A5 models (other models to follow) an improved variable maintenance concept with a revised and simplified maintenance schedule has been introduced to meet the increasingly varied needs of Audi drivers.

As with the original LongLife Service you can opt for the traditional Fixed Interval Inspection servicing (with oil changes every 10,000 miles) or the new enhanced servicing concept.

With this new regime the oil change remains variable and, depending on operating conditions, can be carried out up to 20,000 miles or 2 years.

Enhanced LongLife servicing

Fixed Service intervals:	
Oil-change Service	Every 10,000* miles/1 year
Interval Service	Every 20,000* miles/2 years
Interval Service Inspection	Every 40,000* miles/4 years

However, with enhanced LongLife Servicing, the Inspection Service elements are separate to oil changing. These are carried out for the first time at 3 years or 20,000 miles and then every 2 years/20,000 miles thereafter.

The time and distance remaining until each part of the service is required is displayed separately via the Service Display on the car's computer.

In practice, this new service concept results in lower ownership costs, as maintenance work is carried out when your vehicle really needs it.

Variable Service intervals:	
Interval Service	Flexible to a maximum 20,000* miles/2 years
Interval Service Inspection	Every 20,000* miles/3 years, then every 20,000 miles/2 years thereafter

*Mileages are approximate as the Service Indicator system uses kilometres as its distance measurement.

Service by Design

At Audi, we believe our customers have the right to expect excellent service each and every time they make contact with us. To ensure that this happens, we have agreed a set of service standards with our Audi Centre network that governs the way they do business with you. These standards apply to both Sales and Aftersales, and we actively monitor our Centres to ensure that you receive the highest level of customer service. These service standards will ensure a consistent, stress-free experience whenever you are in contact with anyone representing the Audi brand.

Every Audi Centre will be open during the following hours:

Sales: 9am-6pm Monday to Friday
9am-5pm Saturday

Service: 8am-6pm Monday to Friday
8.30am-1pm Saturday

Sunday opening at local discretion.

Test drives

Whilst we cannot always have the desired demonstrator car ready immediately, we will confirm arrangements for a test drive within two working days (subject to status).

New Car delivery

Once we have confirmed a delivery date with you, we will keep you informed of progress. In the unlikely event of a delay, we will provide you with a courtesy car to minimise inconvenience and keep you mobile.

Delivery to any location within the UK

To maximise your Audi experience right from the first day of ownership, we will deliver your car to your preferred location – whether that's home or your place of work (subject to reasonable notice).

Every attention to detail

Your ownership experience starts with half a tank of fuel.

Quotation response

We are committed to answering any quotation request within 1 working day.

Training

We run a continuous training development programme for all our staff so that we consistently deliver a high-quality, professional service.

Formal complaints procedure

We have a complaints procedure designed to ensure any negative issue you raise with us is dealt with properly.

Courtesy cars

When your car is off the road, perhaps due to a scheduled service or MOT, we will offer you an Audi Courtesy Vehicle until yours is ready. We'll even collect from and deliver to your chosen location, keeping hassle to an absolute minimum.

All our courtesy cars are insured and fuelled

Upon collection or delivery, your courtesy car will have a minimum of a quarter of a tank of fuel; all we ask is that you replace any fuel used before returning it to us. On presentation of your driving licence, we will also insure the car free of charge.

Service bookings

If you do not require a courtesy car, we will service your Audi within a maximum of 5 working days. If you do choose to take a courtesy car, we will promise to service your vehicle within a maximum of 10 working days.

Cleaning

When your car comes to our workshop, we will wash and vacuum it at no extra cost.

No hidden charges

You will be consulted before we carry out any necessary work on your vehicle, and anything charged for will be itemised on your bill. No extra work will be undertaken without your permission.

A personal service

All work will be done by a named Audi Technician, to whom you can personally direct questions or requests should you need to.

Environmental commitment

We promise to dispose of all non-biodegradable materials from your vehicle in a responsible manner.



Pricing information

Pricing

Prices and specifications given are correct at the time of printing. Always check details with your Audi Centre, as Audi policies are continually developing. We reserve the right to change prices or specifications at any time.

All prices are subject to VAT, currently charged at 17.5%.

Delivery charges and numberplates are not included in the vehicle price.

<u>Delivery charge</u>	<u>£469.36</u>
<u>Numberplates</u>	<u>£20.00</u>
<u>VAT</u>	<u>£85.64</u>
<u>Total</u>	<u>£575.00</u>

Audi Roadside Assistance

Your new car comes complete with complimentary roadside assistance and recovery across the UK provided by RAC Motoring Services. Also included is roadside assistance throughout Europe, managed by RAC Motoring Services.

Audi Customer Care

Every new Audi benefits from the comprehensive Audi Customer Care Package, which comprises:

- ▶ A 3-year Audi warranty, which covers you for unlimited mileage in the first 2 years of ownership, with a full mechanical and electrical warranty which covers you for up to 60,000 miles in the third year
- ▶ A 3-year paint warranty
- ▶ A 12-year anti-corrosion warranty
- ▶ Up to 3 years' UK roadside assistance and recovery

This package, together with Audi variable Service intervals, offers a combination unmatched by any other major manufacturer. Contact your Audi Centre for full details.

Audi Tax-Free Sales

If you are entitled to purchase a vehicle free of VAT, normally through Military or Diplomatic privilege, please contact your local Audi Centre for full details.

Should you have any difficulty obtaining the information you require, please call Freephone 0800 585878.

Audi Finance

Audi Finance specialise in providing funding solutions for Audi drivers. Whether your Audi is for private or business use, there are a range of funding options to choose from.

Below is the full range of finance products.

- ▶ Solutions – a Personal Contract Plan
- ▶ Hire Purchase
- ▶ Lease Purchase
- ▶ Finance Lease
- ▶ Contract Hire

With all products, you can choose a fixed-cost maintenance plan designed to help you budget accurately.

No matter what Audi model you choose, your local Audi Centre can provide you with a personalised quote which could fit your budget and motoring needs.

Audi Finance is a trading name of Volkswagen Financial Services (UK) Limited. An offer of finance depends on certain conditions. Available to people over 18 in the UK only.

Audi Insurance

Competitive comprehensive motor insurance designed specially for Audi drivers. All new Audi models come with complimentary seven-day cover upon request – we'll email a cover note directly to your Audi Centre, enabling them to tax your car easily. This way, you can drive straight out of the showroom. Taking out an annual policy is easy and can begin as soon as your free seven-day cover expires.

For more information, contact your local Audi Centre. Alternatively, call 0800 051 3146 for a quote and to receive 7 days' complimentary cover for your new Audi.

Audi Insurance is underwritten and administered by Zurich Insurance Company.

Notes

Notes

Audi UK
Customer Services
Selectapost 29
Sheffield
S97 3FG
0800 699888
www.audi.co.uk

Specifications and
prices subject to
change without notice.

© Audi (UK)

Printed in the UK
Edition 5. 07/08
2009 Model Year



Mixed Sources
Product group from well-managed
forests and other controlled sources

Cert no. TT-COC-002327
www.fsc.org
© 1996 Forest Stewardship Council