



The new Audi A6 and S6 range
Pricing and Specification Guide
Valid from August 2008



A User's Guide

This guide has been designed to help you tailor and price your chosen Audi model quickly and logically. At the back of this guide, you will also find information on CO₂ emissions-based taxation and the other services offered by Audi, including Finance and Insurance.

Table of content

	Page Number
Introduction	
The new A6	4
Engines and quattro	6
Model details and prices	
Standard models	8
SE models	12
S line models	14
S6 models	16
Transmission	20
Colour and upholstery	
Paint finishes	22
Upholstery options	24
Colour and trim guide	30
Inlays	32
Options	
Wheels, tyres and suspension	34
Packages	38
Audio and communication	40
Seats	42
Safety and security	44
Interior equipment	46
Exterior equipment	48
Steering wheels	49
Technical details	
Technical details	50
Dimensions	58
Other information	60

The new Audi A6 Saloon and Avant

The new Audi A6 Saloon and Avant are two of the most desirable models in the prestige market. With the latest edition, we've made some substantial enhancements, bringing increased power, better fuel economy and reduced emissions. We've also added new colour and wheel choices, more energy-efficient LED tail lights as standard and a revised suspension for greater comfort. But one thing hasn't changed: the Le Mans-winning TDI® and FSI® technology that made the previous generation such a success.

There are also some new, even more practical features inside. The MMI Multi-Media Interface, for example, has been upgraded to the third generation, offering a large-capacity hard disk to store more information than ever before. So the images produced by the Satellite Navigation system now look far smoother and more realistic, thanks to textured surfaces and high-speed 3D modelling.

Of course, that's just the beginning. Discover every component of Vorsprung durch Technik for yourself over the following pages.





Engines

Petrol

There are three kinds available on this model – the FSI engine, the turbo-charged TFSI engine and the new supercharged TFSI engine. You'll find FSI® technology at work in the new supercharged 3.0 TFSI engine we've introduced to the A6 range, delivering increased power and torque, as well as enhanced fuel efficiency. And with their reduced CO₂ levels, all but the V10 engine in the S6 are already compliant with proposed EU 5 emissions standards.

Diesel

All diesel engines from Audi are known as TDI® – Turbo Direct Injection. This impressive technology was originally pioneered by Audi in 1989, marking a departure from the noisy, fuel-thirsty diesel engines of the past. Like its FSI® petrol counterpart, the TDI® diesel engine is designed for power and performance, with low fuel consumption and CO₂ emissions. For instance, the new 2.0 TDI engine emits just 139g/km of CO₂, making it one of the cleanest engines in its class, and we've also refined our V6 engines to make them more efficient than ever before. The working principle of TDI® is based upon precision and compression. A turbo-charger supplies fresh air to the engine, ensuring optimum filling of the cylinder. Immediately after compression, an injector then delivers fuel into the combustion chambers at a very high pressure. It's what enables you to get the most in terms of performance and economy from every drop of fuel that enters the tank, and it's the reason why every single TDI® engine in the A6 range already complies with the stringent EU 5 emissions limits scheduled for 2010.



quattro

Permanent four-wheel-drive

It's the technology that has given Audi the edge on the racetrack ever since it was first introduced over 25 years ago – a technology that delivers ultimate control whilst enhancing the athletic characteristics which make the A6 so thrilling to drive. It's called quattro permanent four-wheel-drive. The principle is simple: in the same way that four brakes ensure better deceleration, four permanently-driven wheels deliver better

acceleration and road-holding, pushing or pulling the car as needed, for a driving experience that's both dynamic and safe. In the A6 and S6, asymmetric-dynamic torque distribution continuously distributes drive power between the front and rear axles depending on weather conditions, road surface and gradient, which increases flexibility for an enhanced, more dynamic drive.

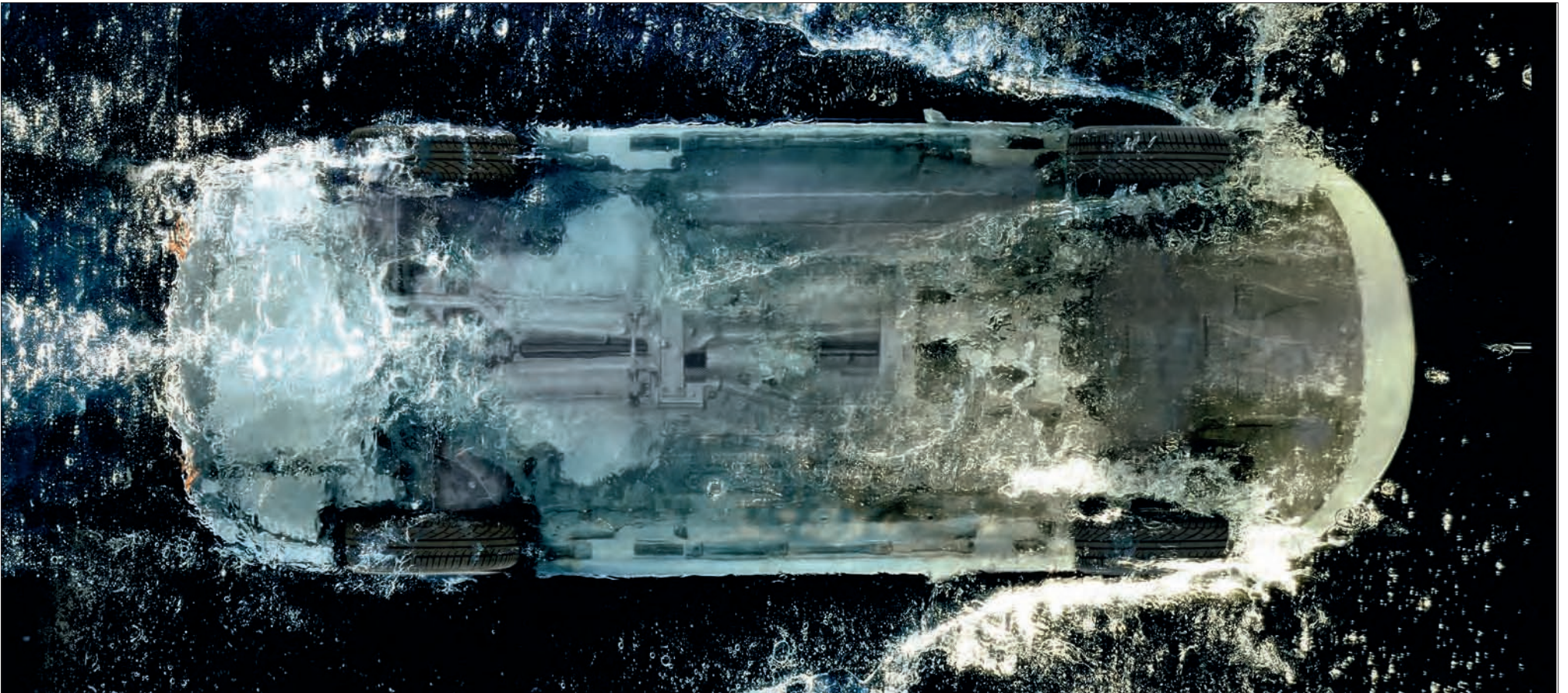

Standard model equipment

All A6 models have the following items of standard equipment

Wheels, tyres and suspension

17" 'Structure' design alloy wheels
Four-link front suspension
Spare wheel – full-size alloy*

Audio and communication

MMI Radio Plus
Single CD player

Safety and security

Active front head restraints
Anti-lock Braking System (ABS) with EBD
Anti-Slip Regulation (ASR) traction control
Brake light – third brakelight in rear window
Brake system: disc brakes at front and rear, ventilated at front
Central locking with radio remote-control
Driver and front passenger two-stage airbags with front passenger airbag deactivation
Dynamic suspension system
Electric child locks for rear doors and windows
Electromechanical Parking Brake
Electronic Differential Lock (EDL) traction control
Exit lights and active reflectors on all doors
Front fog-light
ISOFIX child-seat mounting (front-left and outer-rear seats)
Light and rain sensors including coming/leaving home function
Rear fog-light
servotronic steering – power steering with speed-dependent control
Side airbags for driver and front passenger
Sideguard head airbag system to protect front and outer

rear passengers in a side collision
Side-impact protection in all doors
Thatcham Category 1 alarm and immobiliser
Warning triangle

Seats

3-point seat belts for all seats with front belt-force limiters
Split-folding rear seats
Upholstery – Meridian cloth



*A6 Avant 2.0 TDIe has the Tyre Mobility System in lieu of the full size spare wheel.

Interior equipment

12V power socket in luggage compartment (Avant models only)

12V power socket in rear centre console

4-spoke leather multi-function steering wheel (adjustable for reach and rake)

Aluminium fascia and door trim inlays

Ashtrays, illuminated, at the front of the centre console and in the rear doors

Centre armrests, front and rear, with storage compartment

Coat hooks with cushioned action, two recessed in roof area

Compartment for glasses in front roof module

Cruise control

Cup holder within the centre console storage compartment and a second cup holder beneath the front centre armrest

Driver's Information System (DIS)

Dual-zone electronic climate control

Electric front and rear windows

Floor mats in front and rear

Heated rear window

Heat-insulating glass

Illuminated vanity mirrors

Load area comprising rail system, lashing points and folding load-area floor (Avant models only)

Luggage compartment cover (Avant models only)

Reading lights – two at front and two at rear

Scuff plates with metal inlays

Tool kit in luggage compartment

Exterior equipment

Body-coloured door mirrors, handles and bumpers

Electrically adjustable and heated door mirrors

Halogen headlights with manual range adjustment

Rear window wash/wipe (Avant models only)

Roof rails in aluminium (Avant models only)

Windscreen-washer jets, heated



Standard model prices

Petrol – Saloon

Engines	Power	Transmission	Basic RRP	Total RRP ^{inc. VAT}	Recommended OTR
2.0 TFSI	170PS	6-speed manual	£20,808.51	£24,450.00	£25,250.00
2.0 TFSI	170PS	7-speed multitronic®	£22,042.55	£25,900.00	£26,700.00

Petrol – Avant

Engines	Power	Transmission	Basic RRP	Total RRP ^{inc. VAT}	Recommended OTR
2.0 TFSI	170PS	6-speed manual	£22,144.68	£26,020.00	£26,820.00
2.0 TFSI	170PS	7-speed multitronic®	£23,378.72	£27,470.00	£28,270.00

Diesel – Saloon

Engines	Power	Transmission	Basic RRP	Total RRP ^{inc. VAT}	Recommended OTR
2.0 TDIe	136PS	6-speed manual	£20,468.09	£24,050.00	£24,800.00
2.0 TDI	136PS	7-speed multitronic®	£21,702.13	£25,500.00	£26,250.00

Diesel – Avant

Engines	Power	Transmission	Basic RRP	Total RRP ^{inc. VAT}	Recommended OTR
2.0 TDIe	136PS	6-speed manual	£21,804.26	£25,620.00	£26,370.00
2.0 TDI	136PS	7-speed multitronic®	£23,038.30	£27,070.00	£27,845.00





SE model equipment

In addition to Standard model equipment

Basic RRP	Total RRP ^{inc.} _{VAT}
£1,106.38	£1,300.00

Audio and communication

Mobile phone preparation – low

Safety and security

Auto-dimming rear-view mirror

Seats

Milano leather upholstery



SE model prices

Petrol – Saloon

Engines	Power	Transmission	Basic RRP	Total RRP ^{inc. VAT}	Recommended OTR
2.0 TFSI	170PS	6-speed manual	£21,914.89	£25,750.00	£26,550.00
2.8 FSI	220PS	7-speed multitronic®	£25,617.02	£30,100.00	£30,940.00
2.8 FSI quattro	220PS	6-speed tiptronic®	£26,936.17	£31,650.00	£32,490.00
3.0 TFSI quattro	290PS	6-speed tiptronic®	£29,319.15	£34,450.00	£35,290.00

Petrol – Avant

Engines	Power	Transmission	Basic RRP	Total RRP ^{inc. VAT}	Recommended OTR
2.0 TFSI	170PS	6-speed manual	£23,251.06	£27,320.00	£28,120.00
2.8 FSI	220PS	7-speed multitronic®	£26,953.19	£31,670.00	£32,510.00
2.8 FSI quattro	220PS	6-speed tiptronic®	£28,272.34	£33,220.00	£34,060.00
3.0 TFSI quattro	290PS	6-speed tiptronic®	£30,655.32	£36,020.00	£36,860.00

Diesel – Saloon

Engines	Power	Transmission	Basic RRP	Total RRP ^{inc. VAT}	Recommended OTR
2.0 TDIe	136PS	6-speed manual	£21,574.47	£25,350.00	£26,100.00
2.7 TDI	190PS	6-speed manual	£25,055.32	£29,440.00	£30,215.00
2.7 TDI quattro	190PS	6-speed tiptronic®	£27,608.51	£32,440.00	£33,280.00
3.0 TDI quattro	240PS	6-speed manual	£28,255.32	£33,200.00	£34,000.00

Diesel – Avant

Engines	Power	Transmission	Basic RRP	Total RRP ^{inc. VAT}	Recommended OTR
2.0 TDIe	136PS	6-speed manual	£22,910.64	£26,920.00	£27,670.00
2.7 TDI	190PS	6-speed manual	£26,391.49	£31,010.00	£31,785.00
2.7 TDI quattro	190PS	6-speed tiptronic®	£28,944.68	£34,010.00	£34,850.00
3.0 TDI quattro	240PS	6-speed manual	£29,591.49	£34,770.00	£35,570.00



In addition to SE model equipment

Basic RRP	Total RRP <small>inc. VAT</small>
£1,829.79	£2,150.00

Wheels, tyres and suspension

8J x 18 '5-arm' design alloy wheels with 245/40 R18 Y tyres
Sports suspension (S line suspension available at no extra cost)

Seats

Front Sports seats with S line logo, including electrically adjustable lumbar support for both front seats
Milano leather

Interior equipment

Black cloth headlining
Gear knob in perforated leather
3-spoke leather multi-function steering wheel – with S line logo.
(With shift paddles on automatic models)
Matt-brushed aluminium fascia and door trims

Exterior equipment

Headlight washers
S line body styling (front bumper and rear diffuser in Sports design)
Xenon Plus headlights with LED daytime running lights and kerb lights





S line model prices

Petrol – Saloon

Engines	Power	Transmission	Basic RRP	Total RRP ^{inc. VAT}	Recommended OTR
2.0 TFSI	170PS	6-speed manual	£23,744.68	£27,900.00	£28,700.00
2.8 FSI	220PS	7-speed multitronic®	£27,446.81	£32,250.00	£33,090.00
2.8 FSI quattro	220PS	6-speed tiptronic®	£28,765.96	£33,800.00	£34,640.00
3.0 TFSI quattro	290PS	6-speed tiptronic®	£31,148.94	£36,600.00	£37,440.00

Petrol – Avant

Engines	Power	Transmission	Basic RRP	Total RRP ^{inc. VAT}	Recommended OTR
2.0 TFSI	170PS	6-speed manual	£25,080.85	£29,470.00	£30,270.00
2.8 FSI	220PS	7-speed multitronic®	£28,782.98	£33,820.00	£34,660.00
2.8 FSI quattro	220PS	6-speed tiptronic®	£30,102.13	£35,370.00	£36,210.00
3.0 TFSI quattro	290PS	6-speed tiptronic®	£32,485.11	£38,170.00	£39,010.00

Diesel – Saloon

Engines	Power	Transmission	Basic RRP	Total RRP ^{inc. VAT}	Recommended OTR
2.0 TDIe	136PS	6-speed manual	£23,404.26	£27,500.00	£28,250.00
2.7 TDI	190PS	6-speed manual	£26,885.11	£31,590.00	£32,365.00
2.7 TDI quattro	190PS	6-speed tiptronic®	£29,438.30	£34,590.00	£35,430.00
3.0 TDI quattro	240PS	6-speed manual	£30,085.11	£35,350.00	£36,150.00

Diesel – Avant

Engines	Power	Transmission	Basic RRP	Total RRP ^{inc. VAT}	Recommended OTR
2.0 TDIe	136PS	6-speed manual	£24,740.43	£29,070.00	£29,820.00
2.7 TDI	190PS	6-speed manual	£28,221.28	£33,160.00	£33,935.00
2.7 TDI quattro	190PS	6-speed tiptronic®	£30,774.47	£36,160.00	£37,000.00
3.0 TDI quattro	240PS	6-speed manual	£31,421.28	£36,920.00	£37,720.00



S6 model equipment in addition to A6 standard model equipment

The Audi S6 is confident, imposing and supremely sporty. Whether you opt for Saloon or Avant, this model features one incredibly potent engine – the 5.2 V10 FSI. The first ever V10 from Audi, this 435PS powerhouse has been developed with technical input from Lamborghini. The performance speaks for itself – a 0-62 mph sprint in the Saloon takes just 5.2 seconds, with a mere tenth-of-a-second's difference in the Avant – a fair compromise considering the latter's cavernous 1,660-litre load-capacity. Channelling all that power and maximising both handling and agility, the latest generation of quattro® permanent four-wheel-drive, modified aluminium-based Sports suspension and 19" alloy wheels are also included as standard. Yet even with such impressive performance credentials, the Audi S6 doesn't flaunt its capabilities.

The exterior design is confident yet subtle, including features such as flared front wheel arches, aluminium-look wing mirrors and an integrated rear spoiler. Inside, sports styling and carefully-crafted luxury come together in the laterally-supportive leather/Alcantara Sports seats, multi-function leather Sports steering wheel and sleek carbon fibre inlays in the door panelling, dashboard and centre console. Comfortable, refined – but without compromising the raw sportiness that gives the Audi S6 its unique appeal.

Wheels, tyres and suspension

9J x 19 5-arm 'S' design alloy wheels with 265/35 R19 tyres
Full-size spare wheel

Audio and communication

6-disc CD changer
HDD Satellite
Navigation system
MMI 3G Multi Media Interface with 7" high resolution screen

Interior equipment

Carbon Atlas inlays
Coloured instrument inserts with white needles
Driver's Information System (DIS), in colour
Interior lighting package
Leather trimmed 3-spoke multi-function steering wheel with 'S6' logo, contrasting stitching and gear-change shift paddles in aluminium look
'S' gear knob in leather and aluminium
Storage pack (for details see page 47)

Exterior equipment

80-litre fuel tank
Aluminium-look wing mirrors
Black-painted brake callipers featuring the S6 logo at front (15" brake discs at front, 13" at rear)
LED daytime-running lights integrated in the bumper
Dual-branch oval exhaust system (4 tailpipes)
'S' grille (platinum grey): double vertically-oriented chrome struts, S6 badge
'S' rear spoiler
'S' specific bumpers
'S' specific Sports chassis with latest-generation

quattro® four-wheel-drive, incorporating a 60/40 rear-biased torque-split
S6 door-sill trim in aluminium look
V10 badge on wheel arch
Xenon Plus headlights including headlight washers

Seats

Leather/Alcantara 'S' Sports seats – electrically adjustable with electric lumbar support
Split-folding rear seats





S6 quattro – Saloon

Engines	Power	Transmission	Basic RRP	Total RRP ^{inc. VAT}	Recommended OTR
S6 quattro	435PS	6-speed tiptronic®	£46,727.66	£54,905.00	£55,935.00

S6 quattro – Avant

Engines	Power	Transmission	Basic RRP	Total RRP ^{inc. VAT}	Recommended OTR
S6 quattro	435PS	6-speed tiptronic®	£48,063.83	£56,475.00	£57,505.00

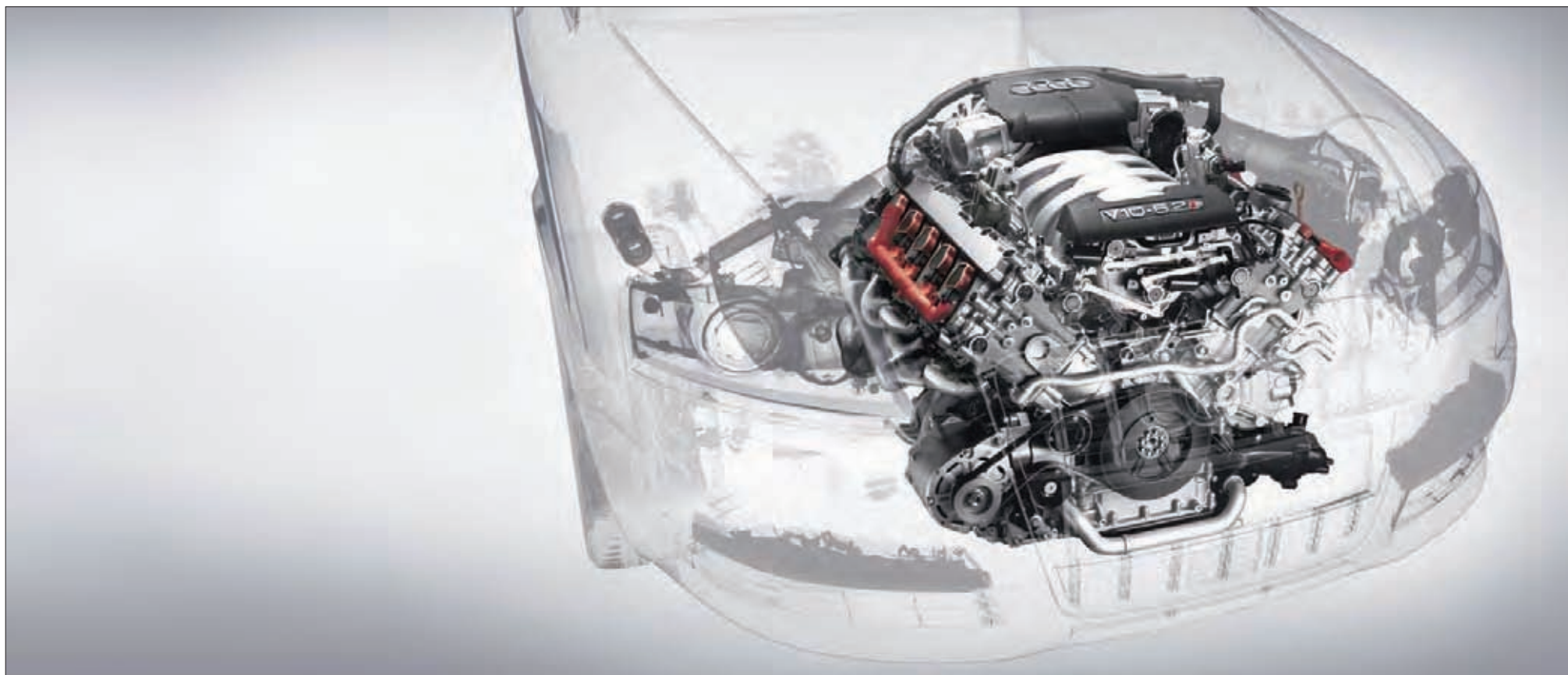

Recommended On-The-Road (OTR) retail prices include: delivery charge, half a tank of fuel, number plates at £575.00 (inc. VAT) and Road Fund Licence (which may vary depending on model/transmission – see page 60 for details) and first registration fee at £55.00.

RRP – Recommended Retail Price.





Transmissions

multitronic®

Audi offers a variety of different transmission options to suit your requirements and driving style. In addition to the classic manual gearbox are two innovative automatic and semi-automatic transmission options. To help you come to an informed decision, each of these is described in detail opposite.

Translating a driver's preferences and intentions into road performance, the multitronic® transmission system entertains no compromises – whether in terms of dynamism, convenience or economy. multitronic® automatic transmission is available on models without quattro® permanent four-wheel-drive. A continuously variable transmission, multitronic® can transmit up to 310 Nm of torque and permits an exceptionally wide range of gear ratios. The result is smooth, powerful acceleration and a high level of driving comfort. And thanks to its lightweight design and a number of advanced electronic control systems that monitor gradient, road conditions and the way the driver is using the accelerator pedal, multitronic® also plays an instrumental role in reducing fuel consumption.

tiptronic®

The 6-speed tiptronic® transmission system is a form of automatic transmission available on Audi models with quattro® permanent four-wheel-drive. The technology converts high-torque engine power into both sporty performance and operating convenience, with crisp, fast gear changes, reduced weight and an optimised gearshift strategy. More spontaneous gear changes are a particular benefit, especially when down-shifting. Both in the 'D' (Drive) and 'S' (Sport) programme, the advanced electronics used in tiptronic® respond efficiently to every driver input, helping to prevent unwanted upshifts when cornering.

Transmissions

	2.0 TDi*	2.7 TDI	2.7 TDI quattro	3.0 TDI quattro	2.0 TFSI	2.8 FSI	2.8 FSI quattro	3.0 TFSI quattro	S6	Basic RRP	Total RRP ^{inc. VAT}
7-speed multitronic® transmission	•	•	-	-	•	S	-	-	-	£1,234.04	£1,450.00
6-speed tiptronic® transmission	-	-	S	•	-	-	S	S	S	£1,191.49	£1,400.00



Options are subject to availability and may extend delivery.
 - = Not available • = Available S = Standard

RRP – Recommended Retail Price.
 Please note that due to higher CO₂ emissions the 2.0 TDI multitronic is not an 'e' model.

Paint finishes

Standard colours



Brilliant black

A2

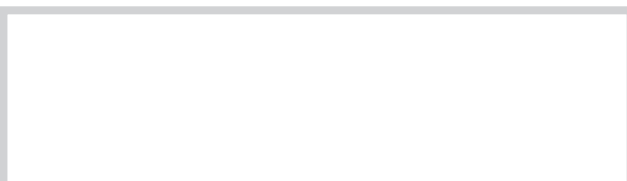

Ibis white

T9

Optional colours

Basic RRP	Total RRP ^{inc.} _{VAT}
£510.64	£600.00



Oyster grey, metallic (not available on S6 models)

X1



Phantom black, pearl effect

L8



Deep green, pearl effect

3W



Ice silver, metallic

P5



Condor grey, metallic

5Q



Quartz grey, metallic

Q4

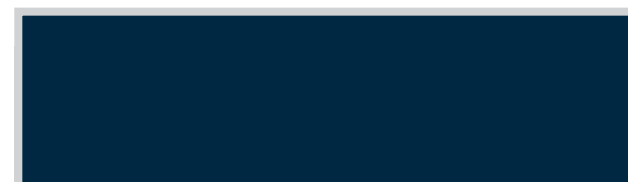

Polar blue, metallic

6A

S6 additional colours

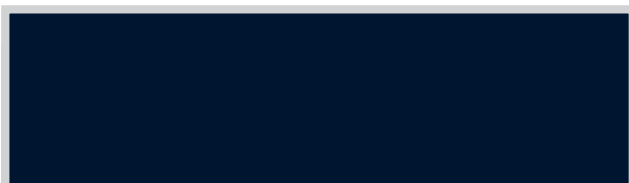

Night blue, pearl effect

7X



Monza silver, metallic (only available on S line models)

U7



Brilliant red

C8

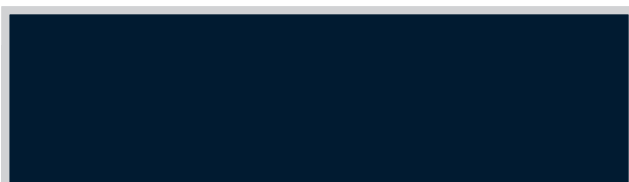

Aventurine blue, pearl effect

7Y



Daytona grey, pearl effect (only available on S line models)

6Y



Sprint blue, pearl effect

5N



Garnet red, pearl effect (not available on S6)

9C



Dakar beige, metallic (not available on S6)

9X



Upholstery

Standard seats

			Standard	SE	S line	S6	Basic RRP	Total RRP ^{inc. VAT}
	GD		G	-	-	-	No charge	No charge
Meridian cloth, Black		Meridian cloth, Light grey						
	GD			-	-	-	£102.13	£120.00
Arkana cloth, Black		Arkana cloth, Light grey						
			G					
		Arkana cloth, Cardamom beige						
	GD			•	-	-	£1,276.60	£1,500.00
Milano leather, Black		Milano leather, Light grey						
			L					
		Milano leather, Amaretto brown						
	G							
Milano leather, Cardamom beige								





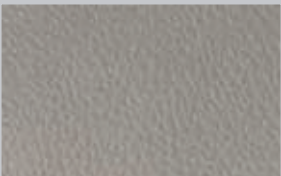
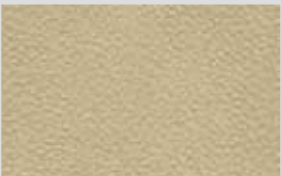

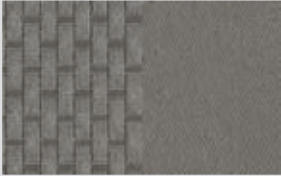

Upholstery

Standard seats

				Standard	SE	S line	S6	Basic RRP	Total RRP ^{inc. VAT}
				•	•	–	–	£1,531.91 £255.32	£1,800.00 £300.00
Valcona leather, Black GD	Valcona leather, Linen beige GS	Valcona leather, Amaretto brown LR		–	–	–	–		
									
Valcona leather, Light grey GV	Valcona leather, Cardamom beige GX								

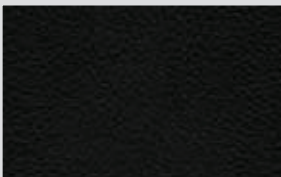



Upholstery

Sports seats (front including 4-way electric lumbar support and manual height adjustment)

		Standard	SE	S line	S6	Basic RRP	Total RRP ^{inc. VAT}
	GD						
	GV						
	GD	•	-	-	-	£404.25	£475.00
	GT	-	•	-	-	£1,936.17	£2,275.00
	GU	-	•	-	-	£659.57	£775.00
	GW						
	GZ						
	GD	•	-	-	-	£1,680.85	£1,975.00
	GV	-	•	-	-	£404.25	£475.00
	GD	•	-	-	-	£1,255.32	£1,475.00
	GV	-	•	-	-	£404.25	£475.00





Upholstery

S line seats (S line embossed)

	Standard	SE	S line	S6	Basic RRP	Total RRP ^{inc. VAT}
 <p>Milano leather, Black GD</p>	-	-	S	-	No charge	No charge
 <p>Sprint cloth/Leather, Black QE/QF</p>	-	-	•	-	No charge	No charge
 <p>Valcona leather, Black QE</p>	-	-	•	-	£255.32	£300.00
 <p>Alcantara/Leather (perforated Alcantara), Black (only in combination with heated seats) QE/QF</p>	-	-	•	-	No charge	No charge

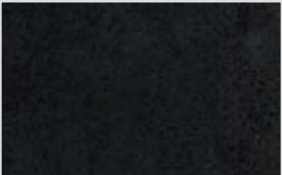
Upholstery

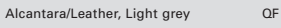
S6 seats (S6 embossed)

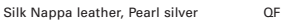
				Standard	SE	S line	S6	Basic RRP	Total RRP <small>inc. VAT</small>
		Alcantara/Leather, Black	QE	-	-	-	S	No charge	No charge
		Alcantara/Leather, Light grey	QF						
		Silk Nappa leather, Black	QE	-	-	-	•	£340.43	£400.00
		Silk Nappa leather, Pearl silver	QF						



Colour and trim guide

Standard seats – Interior trim colours:

Order code	Upholstery	Carpet	Dashboard (upper/lower)	Headlining	Meridian cloth N2C	Arkana cloth N3A	Valcona leather N5D	Milano leather N5W
GD	Black	Black	Black	Silver	●	●	●	●
GS	Linen beige	Black	Black	Linen beige	–	–	●	–
GT	Linen beige/Black	Black	Black	Linen beige	–	–	–	–
LR	Amaretto brown	Black	Black	Amaretto brown	–	–	●	●
GU	Amaretto brown/Black	Black	Black	Amaretto brown	–	–	–	–
GV	Light grey	Light grey	Graphite grey/Light grey	Silver	●	●	●	●
GW	Silver/Light grey	Light grey	Graphite grey/Light grey	Silver	–	–	–	–
GX	Cardamom beige	Cardamom beige	Tan beige	Linen beige	–	●	●	●
GZ	Linen beige/Cardamom beige	Cardamom beige	Tan beige/Cardamom beige	Linen beige	–	–	–	–

Sports seats – Interior trim colours:

Order code	Upholstery	Carpet	Dashboard (upper/lower)	Headlining	Mistral cloth N0D	Valcona leather N5D	Alcantara/Leather N7U	Milano leather N5W
GD	Black	Black	Black	Silver	●	●	●	●
GS	Linen beige	Black	Black	Linen beige	–	–	–	–
GT	Linen beige/Black	Black	Black	Linen beige	–	●	–	–
LR	Amaretto brown	Black	Black	Amaretto brown	–	–	–	–
GU	Amaretto brown/Black	Black	Black	Amaretto brown	–	●	–	–
GV	Light grey	Light grey	Graphite grey/Light grey	Silver	●	–	●	●
GW	Silver/Light grey	Light grey	Graphite grey/Light grey	Silver	–	●	–	–
GX	Cardamom beige	Cardamom beige	Tan beige	Linen beige	–	–	–	–
GZ	Linen beige/Cardamom beige	Cardamom beige	Tan beige/Cardamom beige	Linen beige	–	●	–	–

Options are subject to availability and may extend delivery.
 – = Not available ● = Available S = Standard

Colour and trim guide

S line model seats – Interior trim colours:

Order code	Upholstery	Carpet	Dashboard (upper/lower)	Headlining	Sprint cloth/Leather N7V	Milano cloth N1H	Valcona leather N1V	Alcantara/Leather (embossed) N7K
QE	Black	Black	Black	Black	•	•	•	•
QF	Black/Silver	Black	Black	Black	•	–	–	•





S6 seats – Interior trim colours:

Order code	Upholstery	Carpet	Dashboard (upper/lower)	Headlining	Alcantara/Leather N7U	Silk Nappa leather N1H
QE	Black	Black	Black	Silver	•	•
QF	Pearl silver	Black	Black	Silver	•	•



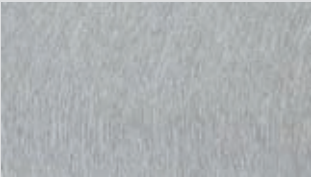

Options are subject to availability and may extend delivery.
 – = Not available • = Available S = Standard

Inlays

Order code			Standard	SE	S line	S6	Basic RRP	Total RRP ^{inc. VAT}
5TD		Radial aluminium	S	S	-	-	No charge	No charge
5TE		Aluminium trigon	•	•	•	-	No charge	No charge
5TG		Matt brushed aluminium	-	-	S	-	No charge	No charge
5TL		Piano finish black (only in combination with S line or Audi exclusive line)	•	•	•	-	£382.98	£450.00
5TZ		Fine-grain Birch wood, grey	-	-	•	-	£297.87	£350.00

Options are subject to availability and may extend delivery.
 - = Not available • = Available S = Standard

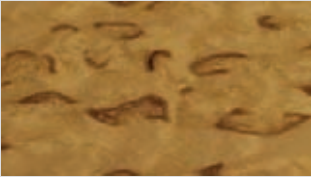
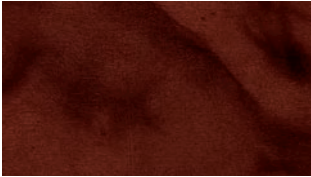
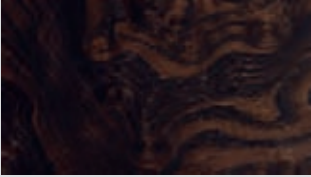
Inlays

Order code			Standard	SE	S line	S6	Basic RRP	Total RRP ^{inc. VAT}
7TC		Fine-grain Birch wood, beige	•	•	•	-	£297.87	£350.00
5MG		Walnut brown	•	•	•	-	£297.87	£350.00
7TL		Fine-grain ash, natural	•	•	•	-	£382.98	£450.00
5MS		Walnut mid-brown, silk matt	-	-	-	•	No charge	No charge

Wheels, tyres and suspension

Order code		Standard	SE	S line	S6	Basic RRP	Total RRP <small>inc. VAT</small>
PRI	17 x 8J '7-spoke Star' design alloy wheels with 245/45 R17 tyres*	•	•	-	-	£297.87	£350.00
PRN	17 x 8J '5-spoke Y' design alloy wheels with 245/45 R17 tyres*	•	•	-	-	£297.87	£350.00
PRK	18 x 8J '10-spoke Star' design alloy wheels with 245/40 R18 tyres*	•	•	-	-	£595.74	£700.00



17 x 8J '7-spoke Star' design alloy wheels



17 x 8J '5-spoke Y' design alloy wheels



18 x 8J '10-spoke Star' design alloy wheels

Wheels, tyres and suspension

		Standard	SE	S line	S6	Basic RRP	Total RRP <small>inc. VAT</small>
PRC	18 x 8J '5-spoke V' design alloy wheels with 245/40 R18 tyres*	•	•	-	-	£595.74	£700.00
PQ5	18 x 8J '10-spoke' design alloy wheels with 245/40 R18 tyres	•	•	-	-	£765.96	£900.00
PRL	18 x 8J '5-arm Dynamic' design highly polished alloy wheels with 245/40 R18 tyres	•	•	-	-	£1,148.94	£1,350.00



18 x 8J '5-spoke V' design alloy wheels



18 x 8J '5-arm Dynamic' design alloy wheels



18 x 8J '10-spoke' design alloy wheels

Options are subject to availability and may extend delivery.
 - = Not available • = Available S = Standard

RRP – Recommended Retail Price.
 *Not available on 2.0 TDi models.

Wheels, tyres and suspension

Order code		Standard	SE	S line	S6	Basic RRP	Total RRP <small>inc. VAT</small>
PQR	18 x 8J '5-spoke' design alloy wheels with 245/50 R18 tyres	• -	• -	- S	- -	£765.96 No charge	£900.00 No charge
PQW	18 x 8J '9-spoke' design alloy wheels with 245/40 R18 tyres*	• -	• -	- •	- -	£765.96 No charge	£900.00 No charge
PQH	18 x 8J '15-spoke' design alloy wheels with 245/40 R18 tyres	• -	• -	- •	- -	£765.96 No charge	£900.00 No charge



18 x 8J '5-spoke' design alloy wheels



18 x 8J '9-spoke' design alloy wheels



18 x 8J '15-spoke' design alloy wheels

Wheels, tyres and suspension

Order code		Standard	SE	S line	S6	Basic RRP	Total RRP <small>inc. VAT</small>
PQS	19 x 8.5J '20-spoke two-piece' design alloy wheels with 255/35 R19 tyres*	• -	• -	- •	- -	£1,148.94 £382.98	£1,350.00 £450.00
PQF	19 x 8.5J '7-double spoke' design alloy wheels with 255/35 R19 tyres*	• -	• -	- •	- -	£1,148.94 £382.98	£1,350.00 £450.00
1BK	Adaptive air suspension. Electronically-controlled pneumatic shock-absorption with four modes (automatic, comfort, dynamic and lift) selected via MMI. Includes automatic level regulation. (Not available on 2.0 TDIe or S line models)	•	•	-	-	£1,276.60	£1,500.00



19 x 8.5J '20-spoke two-piece' design alloy wheels



19 x 8.5J '7-double spoke' design alloy wheels



Adaptive air suspension

Options are subject to availability and may extend delivery.
 - = Not available • = Available S = Standard

RRP – Recommended Retail Price.
 *Not available on 2.0 TDIe models.

Packages

Communications Pack – Low

	Standard	SE	S line	S6	Basic RRP	Total RRP <small>inc. VAT</small>
DVD Satellite Navigation – Low with Audi Music Interface*	•	•	•	–	£1,191.49	£1,400.00
DVD Satellite Navigation – Low with CD changer	•	•	•	–	£1,191.49	£1,400.00
DVD Satellite Navigation – Low with CD changer and Audi Music Interface*	•	•	•	–	£1,446.81	£1,700.00

DVD Satellite Navigation – Low. DVD-based route planning and guidance with MMI-control logic and 6.5" colour monitor, 3D map display, RDS radio, DVD-player for Navigation system, audio or MP3 CD's. Includes European coverage disc

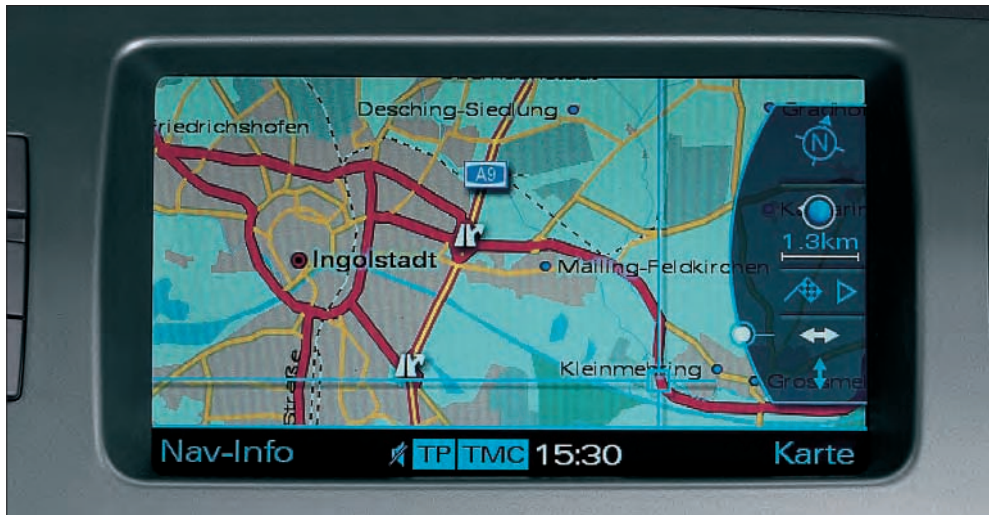

Packages

Communications Pack – High

	Standard	SE	S line	S6	Basic RRP	Total RRP <small>inc. VAT</small>
HDD Satellite Navigation with MMI 3G – High with Audi Music Interface*	•	•	•	-	£1,617.02	£1,900.00
HDD Satellite Navigation with MMI 3G – High with CD changer	•	•	•	-	£1,617.02	£1,900.00
HDD Satellite Navigation with MMI 3G – High with CD changer and Audi Music Interface*	•	•	•	-	£1,872.34	£2,200.00

HDD Satellite Navigation with MMI 3G. 3rd generation of MMI including 2 FM tuners, high resolution (800x400) 7" colour TFT display, 2 SD card readers, 40GB hard drive, 10GB of which can be used to store up to 4,000 songs. HDD Navigation functionality includes advanced speech recognition, 3D and topographical mapping display and advanced 3D building display



Options are subject to availability and may extend delivery.
 - = Not available • = Available S = Standard

RRP – Recommended Retail Price.
 *For further details see page 40

Audio and communication

Order code		Standard	SE	S line	S6	Basic RRP	Total RRP <small>inc. VAT</small>
UF7	Audi Music Interface. Universal connection for use with stereo audio sources and Apple iPod generation 4 onwards (iPod, iPod mini, iPod nano, iPod photo, iPod video and iPod touch). Provides intuitive control through the MMI and multi-function steering wheel. It also replicates the iPod display on the audio screen, including track titles	•	•	•	•	£170.12	£200.00
8RY	BOSE® surround system, 8 channel amplifier, 5 sound settings including surround sound, dynamic noise compensation, 13 loud speakers including centre speaker in dashboard and two surround speakers in parcel shelf, 330 Watts total output	•	•	•	•	£489.36	£575.00
7A6	CD Changer, located in glovebox	•	•	•	S	£255.32	£300.00
QV3	DAB module, Digital Audio Broadcasting radio reception. Allows interference-free radio reception and a larger range of stations. Only in combination with Comms Pack High or Low	•	•	•	•	£293.62	£345.00
P14/9Q4	Driver's Information System – colour	•	•	•	S	£106.38	£125.00
PT5	Mobile telephone preparation – low, located in front centre armrest. Uses Bluetooth interface or cradle to connect to your A6. Includes voice control for phone functions, external aerial for optimal reception and charging facility via cradle (required at extra cost – please see your Audi Centre for phone compatibility)	•	S	S	N	£361.70	£425.00



Audi Music Interface



BOSE surround system

Audio and communication

Order code		Standard	SE	S line	S6	Basic RRP	Total RRP <small>inc. VAT</small>
9ZW	Mobile telephone preparation – High , uses Bluetooth interface with no physical connection to your A6, including roof aerial for optimal reception. It is recommended that your mobile phone has SIM-Access Profile facility for full functionality	• -	- •	- •	- S	£553.19 £191.49	£650.00 £225.00
PT4	Mobile telephone preparation – High with Bluetooth privacy handset located in front centre armrest. Enables discreet calls via cordless handset, and simple inputting of text messages. SIM card can be integrated directly in to the handset if the mobile phone does not have SIM-Access Profile (SAP)	•	•	•	•	£808.51	£950.00
9WM	Rear Seat Entertainment Package. Fitted to the back of the A6 front seats. The package includes 2 detachable DVD players/monitors (supplied by Audi Genuine Accessories) that can be used both inside and outside of the A6. The driver and passenger front seats are fitted with the mountings and a power connection for the DVD players when the entertainment system is used inside the A6. Usage outside the A6 is via a rechargeable battery or mains power connection that is included in the package. Includes individual remote controls	•	•	•	•	£846.81	£995.00
QV9	TV reception – analogue and digital. For improved reception of 'free-to-air' TV channels. Picture reception only possible when vehicle is stationary, sound reception at all other times. (Only in combination with MMI or MMI 3G)	•	•	•	•	£680.85	£800.00
QU1	TV reception and DAB digital radio. Analogue and digital reception. (Only in combination with MMI or MMI 3G)	•	•	•	•	£974.47	£1,145.00



BOSE surround sound

Options are subject to availability and may extend delivery.
 - = Not available • = Available S = Standard

RRP – Recommended Retail Price.

Seats

Order code		Standard	SE	S line	S6	Basic RRP	Total RRP <small>inc. VAT</small>
3LE	Door armrest in leather (not available in combination with cloth seats)	•	•	•	•	£178.72	£210.00
PV1	Electric front seats , with adjustment for height, front and back position, backrest angle and lumbar support	•	•	-	-	£638.30	£750.00
		-	-	•	S	£468.09	£550.00
PV3	Electric front seats , driver's side with memory, as above with memory for driver's seat. Also includes memory for door mirrors and electrically adjusted steering column (if fitted). (Must be combined with memory mirrors)	•	•	-	-	£936.17	£1,100.00
		-	-	•	-	£765.96	£900.00
		-	-	-	•	£297.87	£350.00
PV6	Electric front seats with memory , as above with memory for driver's and front passenger's seat (only in combination with memory mirrors)	•	•	-	-	£1,063.83	£1,250.00
		-	-	•	-	£893.62	£1,050.00
		-	-	-	•	£425.53	£500.00



Door armrest in leather



Electric front seats



Electric front seats, driver's side with memory

Seats

Order code		Standard	SE	S line	S6	Basic RRP	Total RRP <small>inc. VAT</small>
7P1	Electric lumbar support , for driver's and front passenger seats, with electric horizontal and vertical lumbar adjustment	•	•	•	S	£170.21	£200.00
4A4	Heated front and outer rear seats . Individually controlled with variable temperature adjustment	•	•	•	•	£468.09	£550.00
4A3	Heated front seats . Individually controlled with variable temperature adjustment	•	•	•	S	£238.30	£280.00
3X2	Through-load facility with removable ski bag , for transporting long objects	•	•	•	•	£136.17	£160.00



Sports seats, electric



Through-load facility with removable ski bag

Options are subject to availability and may extend delivery.
 – = Not available • = Available **S** = Standard

Safety and security

Order code		Standard	SE	S line	S6	Basic RRP	Total RRP <small>inc. VAT</small>
7X1	Acoustic parking system – rear. Aids parking by acoustically indicating distances of obstacles behind your A6	•	•	•	•	£255.32	£300.00
7X4	Acoustic parking system plus. Aids parking by acoustically and graphically indicating distances in front of and behind your A6	•	•	•	•	£489.36	£575.00
8T4	Adaptive Cruise Control (ACC). Automatic distance regulation. Uses radar sensors to maintain required distance by braking and accelerating. Four programs (distance 1 to distance 4) set via steering column controls of the Cruise Control system	•	•	•	•	£936.17	£1,100.00
PU1	Audi lane assist. Uses a discreet camera at the top of the windscreen to monitor the road ahead. The driver is warned via a vibration of the steering wheel if the vehicle is about to exit the lane unintentionally. (Only in combination with 4-spoke multi-function steering wheel)	•	•	•	•	£340.43	£400.00
7X8	Audi Parking System Advanced. Aids parking by acoustically and visually indicating distances in front of (acoustic only) and behind your A6. Uses guidelines to aid reversing. Measured by ultrasonic sensors with camera integrated discreetly in the boot handle	•	•	•	•	£808.51	£950.00
7Y1	Audi side assist. Aids the driver when changing lane. Audi side assist monitors the area behind your A6, using radar sensors located discreetly in the rear bumper and informs the driver via a visual warning signal in the door mirror if there is a vehicle in their blind spot	•	•	•	•	£382.98	£450.00



Acoustic parking system plus



Audi Parking System Advanced

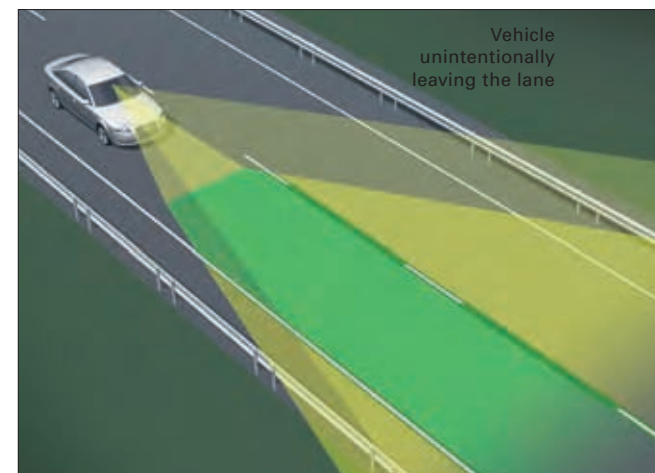

Audi lane assist

Safety and security

Order code		Standard	SE	S line	S6	Basic RRP	Total RRP <small>inc. VAT</small>
PU2	Audi side assist and Audi lane assist. (Only in combination with a 4-spoke multi-function steering wheel)	•	•	•	•	£723.40	£850.00
6XE	Door mirrors – electrically folding	•	•	•	•	£106.38	£125.00
PAK	Door mirrors – electrically folding and auto-dimming	•	•	•	•	£212.77	£250.00
1T3	First-aid kit	•	•	•	•	£17.02	£20.00
4KF	Privacy glass, dark tinted glass from B-pillar backwards	•	•	•	•	£276.60	£325.00
4X4	Rear side airbags, situated in side of rear seats. Provided additional protection for rear seat passengers	•	•	•	•	£255.32	£300.00
7K6	Tyre pressure monitoring system. The driver is given a visual and acoustic warning when the system detects loss of pressure from one of the tyres	•	•	•	•	£72.34	£85.00



Options are subject to availability and may extend delivery.
 – = Not available • = Available S = Standard

RRP – Recommended Retail Price.

Interior equipment

Order code		Standard	SE	S line	S6	Basic RRP	Total RRP <small>inc. VAT</small>
0M5	80-litre fuel tank	•	•	S	S	£63.83	£75.00
4F2	Advanced key , Access and car mobilisation authorisation system through automatic exchange of data between car and key; includes engine start/stop button and locking buttons on top of door handles	•	•	•	•	£680.85	£800.00
6Q6	Aluminium gear knob (available on manual S line models only)	–	–	•	–	£63.83	£75.00
VC1	Garage door opener (HomeLink®) . Programmable radio-operated remote control, control buttons integrated in the roof module at the front	•	•	•	•	£161.70	£190.00
6NQ	Headlining in black cloth (only with colour combinations GD, GS, GT, LR, GU)	•	•	S	•	£170.21	£200.00
QQ1	Light package , illumination of the door storage compartments, the floor area and the inside door handles with LED technology, swivelling reading lights in the roof module at the rear, map-reading lights in the front overhead console and exterior lighting integrated into door mirror	•	•	•	S	£191.49	£225.00
3GN	Load-area fixing kit , with telescopic bar and securing belt for dividing up luggage compartment (Avant models only)	•	•	•	•	£106.38	£125.00
4Y2	Load-area lockable side compartment . Storage compartment cover to right of luggage area, lockable with vehicle key (Avant models only)	•	•	•	•	£34.04	£40.00



Advanced key



Exterior lighting integrated into door mirrors



Load-area fixing kit

Interior equipment

Order code		Standard	SE	S line	S6	Basic RRP	Total RRP <small>inc. VAT</small>
PKH	Luggage compartment package , comprising tie-down straps and 12V socket (standard on Avant models)	•	•	•	•	£63.83	£75.00
3Y2	Rear window blind, electric (Saloon models only)	•	•	•	•	£200.00	£235.00
3Y5	Rear window blind, electric , with manual side blinds (Saloon models only)	•	•	•	•	£276.60	£325.00
3Y1	Rear window blind, manual (Avant models only)	•	•	•	•	£85.11	£100.00
3Y3	Rear window blind, manual , with manual side blinds (Avant models only)	•	•	•	•	£170.21	£200.00
6SJ	Reversible mat for luggage compartment , one side in rubber and the other in fabric	•	•	•	•	£63.83	£75.00
QE1	Storage pack , comprising luggage nets on the back of front seats and in passenger footwell, drawers under front seats and two drinks holders in rear armrest. Also includes luggage compartment net on Avant models	Saloon	•	•	–	£72.34	£85.00
PAC		Avant	•	•	S	£85.11	£100.00



Rear window blind, electric



Reversible mat for luggage compartment

Options are subject to availability and may extend delivery.
 – = Not available • = Available S = Standard

RRP – Recommended Retail Price.

Exterior equipment

Order code		Standard	SE	S line	S6	Basic RRP	Total RRP <small>inc. VAT</small>
8Q6/PX4	Adaptive lights with kerb light , dynamic cornering light with pivoting headlights, including Xenon Plus headlights, headlight washers and automatic, dynamic beam angle adjustment and kerb light. Includes Xenon Plus headlights and headlight washers. (Please note that kerb lighting is not available on S6 models)	–	–	•	•	£319.15	£375.00
PGA	Automatically actuated boot lid , automatically opens and closes the boot lid electrically, opened via radio-operated remote car key, button in the driver's door or the soft-touch button in the boot-lid recess; closed by pressing the button on the inside of the boot lid (Avant models only)	•	•	•	•	£340.43	£400.00
4E5	Automatically opening boot lid , when you open the luggage compartment the lid automatically opens to make loading easier (Saloon models only)	•	•	•	•	£25.53	£30.00
4ZM	Black styling pack . Grille surround, number plate holder, window surround and roof rails (Avant only) in matt black	•	•	•	•	£340.43	£400.00
2Z7	Deletion of capacity designation at rear	•	•	•	•	No charge	No charge
2Z0	Deletion of model and capacity designation at rear	•	•	•	•	No charge	No charge
3FE	Electric slide-and-tilt glass sunroof with position pre-selection, tinted glass insert, variable sunshield and convenient closing	•	•	•	•	£723.40	£850.00
3FR	Electric slide-and-tilt solar-panel sunroof with position pre-selection, uses the sun's energy to supply a constant flow of air to reduce the temperature inside a parked car. Not available on 2.0 TDIe	•	•	•	•	£1,000.00	£1,175.00
8N7	High-beam assistant (only in combination with auto-dimming rear-view mirror and Xenon Plus headlights)	–	–	•	•	£93.62	£110.00
PZH	Power door closure	•	•	•	•	£297.87	£350.00
3S2	Roof bars, black	•	•	•	•	No charge	No charge
3S0	Roof bars, deleted	•	•	•	•	No charge	No charge
1D4	Towing equipment – swivelling, manual	•	•	•	•	£638.30	£750.00

Steering Wheels

Order code		Standard	SE	S line	S6	Basic RRP	Total RRP <small>inc. VAT</small>
1XW (S line 2PU)	3-spoke leather Sports multi-function steering wheel (manual models only)	•	•	•	-	£85.11	£100.00
1XX (S line 2PU)	3-spoke leather Sports multi-function steering wheel with gear-change paddles (automatic models only)	•	•	•	S	£85.11	£100.00
2C7	Electrically adjustable steering column , with adjustment for height and reach and easy-exit function	•	•	•	•	£255.32	£300.00
2ZM	Heated steering wheel . Leather-covered 4-spoke multi-function steering wheel (manual models only)	•	•	•	-	£136.17	£160.00
2ZD	Heated steering wheel . Leather-covered 4-spoke multi-function steering wheel with gear-change paddles (automatic models only)	•	•	•	•	£136.17	£160.00
P32	Wooden 3-spoke Sports multi-function steering wheel with gear-change paddles (only on automatic models and in combination with inlays in Walnut brown – includes wooden gear lever)	•	•	-	-	£221.28	£260.00
6F9	Wooden segmented rim for steering wheel , only in combination with 4-spoke multi-function design with gear change paddles, and inlays in Walnut brown or Fine grain Birch wood Beige (not in combination with Audi exclusive inlays – includes wooden gear knob)	•	•	-	-	£157.45	£185.00



3-spoke leather Sports multi-function steering wheel



Wooden 3-spoke Sports multi-function steering wheel

Options are subject to availability and may extend delivery.
 - = Not available • = Available S = Standard

RRP – Recommended Retail Price.

Technical data

A6 Saloon – Petrol

Engine	Cylinder	Displacement, cubic cm (valves per cylinder)	Max. power ¹ , PS at rpm	Max. torque, Nm at rpm	Transmission	CO ₂ emissions ² , g/km	0-62mph acceleration, seconds	Top speed, mph	ABI insurance group
2.0 TFSI	4-cylinder	1984	170/4300	280/1800	6-speed manual	174	8.2	142	TBC
2.0 TFSI	4-cylinder	1984	170/4300	280/1800	7-speed multitronic®	179	8.5	139	TBC
2.8 FSI	V6	2773	220/5750	280/3000	7-speed multitronic®	197	7.3	149	TBC
2.8 FSI quattro	V6	2773	220/5750	280/3000	6-speed tiptronic®	212	7.7	149	TBC
3.0 TFSI quattro	V6	2995	290/4850	420/2500	6-speed tiptronic®	219	5.9	155*	TBC
S6 quattro	V10	5204	435/6800	540/3000	6-speed tiptronic®	299	5.2	155*	TBC

*Electronically Limited

¹The given value was obtained in accordance with the specified measurement procedure (the respective current version of the Directive 80/1269/EEC).

²The given values were calculated in accordance with the specified measurement procedure (the respective current version of Directive 80/1268/EEC). This information does not relate to a single vehicle and does not comprise part of the offer but is merely intended for the purpose of comparison between the different vehicle types.

Unladen weight ³	Weights, kg		Max. trailer load ⁴ , kg			Volumes		Fuel consumption, mpg (l/100km)		
	Gross weight limit	Roof load limit/nose weight	unbraked	with 12% gradient	with 8% gradient	Luggage compartment capacity, cubic litres	Fuel tank capacity approx, litres	Urban	Extra Urban	Combined
1520	2100	100/85	750	1400	1600	546	70	27.7 (10.2)	47.9 (5.9)	37.7 (7.5)
1550	2130	100/85	750	1500	1700	546	70	27.2 (10.4)	46.3 (6.1)	36.7 (7.7)
1570	2150	100/85	750	1900	2000	546	70	23.9 (11.8)	44.1 (6.4)	33.6 (8.4)
1680	2260	100/85	750	1900	2100	546	80	22.2 (12.7)	40.9 (6.9)	31.4 (9.0)
1725	2305	100/85	750	1900	2100	546	80	21.4 (13.2)	39.8 (7.1)	30.1 (9.4)
1910	2490	100/85	750	2100	2100	546	80	15.3 (18.5)	31.0 (9.1)	22.4 (12.6)

³Vehicle's unladen weight without driver (calculated in accordance with the current version of Directive 80/1268/EEC). The fitting of additional equipment may increase the vehicle's unladen weight and drag coefficient, whereupon the potential carrying capacity and top speed will be correspondingly reduced.

⁴The engine's power output always goes down with increasing altitude. At 1000m above sea level, and for every additional 1000m, deduct 10% from the weight of the outfit (trailer load limit + gross weight of the towing vehicle).

Technical data

A6 Saloon – Diesel

Engine	Cylinder	Displacement, cubic cm (valves per cylinder)	Max. power ¹ , PS at rpm	Max. torque, Nm at rpm	Transmission	CO ₂ emissions ⁴ , g/km	0-62mph acceleration, seconds	Top speed, mph	ABI insurance group
2.0 TDi	4-cylinder	1968	136/4000	320/1750	6-speed manual	139	10.3	129	TBC
2.0 TDI	4-cylinder	1968	136/4000	320/1750	7-speed multitronic®	151	9.9	127	TBC
2.7 TDI	V6	2698	190/3500	380/1400	6-speed manual	164	7.9	144	TBC
2.7 TDI	V6	2698	190/3500	380/1400	7-speed multitronic®	169	7.9	141	TBC
2.7 TDI quattro	V6	2698	190/3500	450/1750	6-speed tiptronic®	189	8.2	143	TBC
3.0 TDI quattro	V6	2967	239/4000	450/1400	6-speed manual	179	6.6	155	TBC
3.0 TDI quattro	V6	2967	239/4000	450/1400	6-speed tiptronic®	189	6.8	155	TBC

¹The given value was obtained in accordance with the specified measurement procedure (the respective current version of the Directive 80/1269/EEC).

²The given values were calculated in accordance with the specified measurement procedure (the respective current version of Directive 80/1268/EEC). This information does not relate to a single vehicle and does not comprise part of the offer but is merely intended for the purpose of comparison between the different vehicle types.

Unladen weight ²	Weights, kg		Max. trailer load ³ , kg			Volumes		Fuel consumption, mpg (l/100km)		
	Gross weight limit	Roof load limit/nose weight	unbraked	with 12% gradient	with 8% gradient	Luggage compartment capacity, cubic litres	Fuel tank capacity approx, litres	Urban	Extra Urban	Combined
1550	2130	100/85	750	1500	1700	546	70	40.4 (7.0)	65.7 (4.3)	53.3 (5.3)
1575	2155	100/85	750	1600	1800	546	70	38.7 (7.3)	57.6 (4.9)	48.7 (5.8)
1635	2215	100/85	750	1600	1800	546	70	34.0 (8.3)	56.5 (5.0)	45.6 (6.2)
1660	2240	100/85	750	1800	1900	546	70	35.3 (8.0)	51.4 (5.5)	44.1 (6.4)
1765	2345	100/85	750	1900	2100	546	80	30.1 (9.4)	48.7 (5.8)	39.8 (7.1)
1760	2340	100/85	750	1800	2000	546	80	31.7 (8.9)	52.3 (5.4)	42.2 (6.7)
1785	2365	100/85	750	1900	2100	546	80	30.4 (9.3)	48.7 (5.8)	39.8 (7.1)

²Vehicle's unladen weight without driver (calculated in accordance with the current version of Directive 80/1268/EEC). The fitting of additional equipment may increase the vehicle's unladen weight and drag coefficient, whereupon the potential carrying capacity and top speed will be correspondingly reduced.

³The engine's power output always goes down with increasing altitude. At 1000m above sea level, and for every additional 1000m, deduct 10% from the weight of the outfit (trailer load limit + gross weight of the towing vehicle).

Technical data

A6 Avant – Petrol

Engine	Cylinder	Displacement, cubic cm (valves per cylinder)	Max. power ¹ , PS at rpm	Max. torque, Nm at rpm	Transmission	CO ₂ emissions ⁴ , g/km	0-62mph acceleration, seconds	Top speed, mph	ABI insurance group
2.0 TFSI	4-cylinder	1984	170/4300	280/1800	6-speed manual	174	8.5	139	TBC
2.0 TFSI	4-cylinder	1984	170/4300	280/1800	7-speed multitronic®	181	8.8	137	TBC
2.8 FSI	V6	2773	220/5750	280/3000	7-speed multitronic®	199	7.6	146	TBC
2.8 FSI quattro	V6	2773	220/5750	280/3000	6-speed tiptronic®	214	7.9	146	TBC
3.0 TFSI quattro	V6	2968	290/4850	420/2500	6-speed tiptronic®	223	6.1	155*	TBC
S6 quattro	V10	5204	435/6800	540/3000	6-speed tiptronic®	299	5.3	155*	TBC

¹The given value was obtained in accordance with the specified measurement procedure (the respective current version of the Directive 80/1269/EEC).

²The given values were calculated in accordance with the specified measurement procedure (the respective current version of Directive 80/1268/EEC). This information does not relate to a single vehicle and does not comprise part of the offer but is merely intended for the purpose of comparison between the different vehicle types.

Unladen weight ²	Weights, kg		Max. trailer load ³ , kg			Volumes		Fuel consumption, mpg (l/100km)		
	Gross weight limit	Roof load limit/nose weight	unbraked	with 12% gradient	with 8% gradient	Luggage compartment capacity, cubic litres	Fuel tank capacity approx, litres	Urban	Extra Urban	Combined
1590	2220	100/85	750	1400	1600	546/1660	70	27.7 (10.2)	47.9 (5.9)	37.7 (7.5)
1125	2250	100/85	750	1500	1700	546/1660	70	26.9 (10.5)	45.6 (6.2)	36.2 (7.8)
1640	2270	100/85	750	1900	2000	546/1660	70	23.5 (12.0)	43.5 (6.5)	33.2 (8.5)
1740	2370	100/85	750	1900	2100	546/1660	80	22.1 (12.8)	40.4 (7.0)	31.0 (9.1)
1790	2420	100/85	750	1900	2100	546/1660	80	21.2 (13.3)	39.2 (7.2)	29.7 (9.5)
1970	2600	100/85	750	2100	2100	546/1660	80	15.3 (18.5)	31.0 (9.1)	22.4 (12.6)

²Vehicle's unladen weight without driver (calculated in accordance with the current version of Directive 80/1268/EEC). The fitting of additional equipment may increase the vehicle's unladen weight and drag coefficient, whereupon the potential carrying capacity and top speed will be correspondingly reduced.

³The engine's power output always goes down with increasing altitude. At 1000m above sea level, and for every additional 1000m, deduct 10% from the weight of the outfit (trailer load limit + gross weight of the towing vehicle).

Technical data

A6 Avant – Diesel

Engine	Cylinder	Displacement, cubic cm (valves per cylinder)	Max. power ¹ , PS at rpm	Max. torque, Nm at rpm	Transmission	CO ₂ emissions ⁴ , g/km	0-62mph acceleration, seconds	Top speed, mph	ABI insurance group
2.0 TDi	4-cylinder	1968	136/4000	320/1750	6-speed manual	139	10.7	128	TBC
2.0 TDi	4-cylinder	1968	136/4000	320/1750	multitronic®	155	10.2	124	TBC
2.7 TDI	V6	2698	190/3500	380/1400	6-speed manual	164	8.2	142	TBC
2.7 TDI	V6	2698	190/3500	380/1400	multitronic®	172	8.2	139	TBC
2.7 TDI quattro	V6	2698	190/3500	450/1750	6-speed tiptronic®	189	8.4	140	TBC
3.0 TDI quattro	V6	2967	240/4000	450/1750	6-speed manual	179	6.8	152	TBC
3.0 TDI quattro	V6	2967	240/4000	450/1750	6-speed tiptronic®	189	7.0	152	TBC

¹The given value was obtained in accordance with the specified measurement procedure (the respective current version of the Directive 80/1269/EEC).

²The given values were calculated in accordance with the specified measurement procedure (the respective current version of Directive 80/1268/EEC). This information does not relate to a single vehicle and does not comprise part of the offer but is merely intended for the purpose of comparison between the different vehicle types.

Unladen weight ²	Weights, kg		Max. trailer load ³ , kg			Volumes		Fuel consumption, mpg (l/100km)		
	Gross weight limit	Roof load limit/nose weight	unbraked	with 12% gradient	with 8% gradient	Luggage compartment capacity, cubic litres	Fuel tank capacity approx, litres	Urban	Extra Urban	Combined
1620	2250	100/85	750	1500	1700	565/1660	70	40.4 (7.0)	65.7 (4.3)	53.3 (5.3)
1645	2275	100/85	750	1600	1800	565/1660	70	37.7 (7.5)	56.5 (5.0)	47.9 (5.9)
1705	2335	100/85	750	1600	1800	565/1660	70	34.0 (8.3)	56.5 (5.0)	45.6 (6.2)
1735	2365	100/85	750	1800	1900	565/1660	70	34.9 (8.1)	50.4 (5.6)	43.5 (6.5)
1825	2455	100/85	750	1900	2100	565/1660	80	30.1 (9.4)	48.7 (5.8)	39.8 (7.1)
1820	2450	100/85	750	1800	2000	565/1660	80	31.7 (8.9)	52.3 (5.4)	42.2 (6.7)
1845	2475	100/85	750	1900	2100	565/1660	80	30.4 (9.3)	48.7 (5.8)	39.8 (7.1)

²Vehicle's unladen weight without driver (calculated in accordance with the current version of Directive 80/1268/EEC). The fitting of additional equipment may increase the vehicle's unladen weight and drag coefficient, whereupon the potential carrying capacity and top speed will be correspondingly reduced.

³The engine's power output always goes down with increasing altitude. At 1000m above sea level, and for every additional 1000m, deduct 10% from the weight of the outfit (trailer load limit + gross weight of the towing vehicle).

Dimensions

A6 Saloon

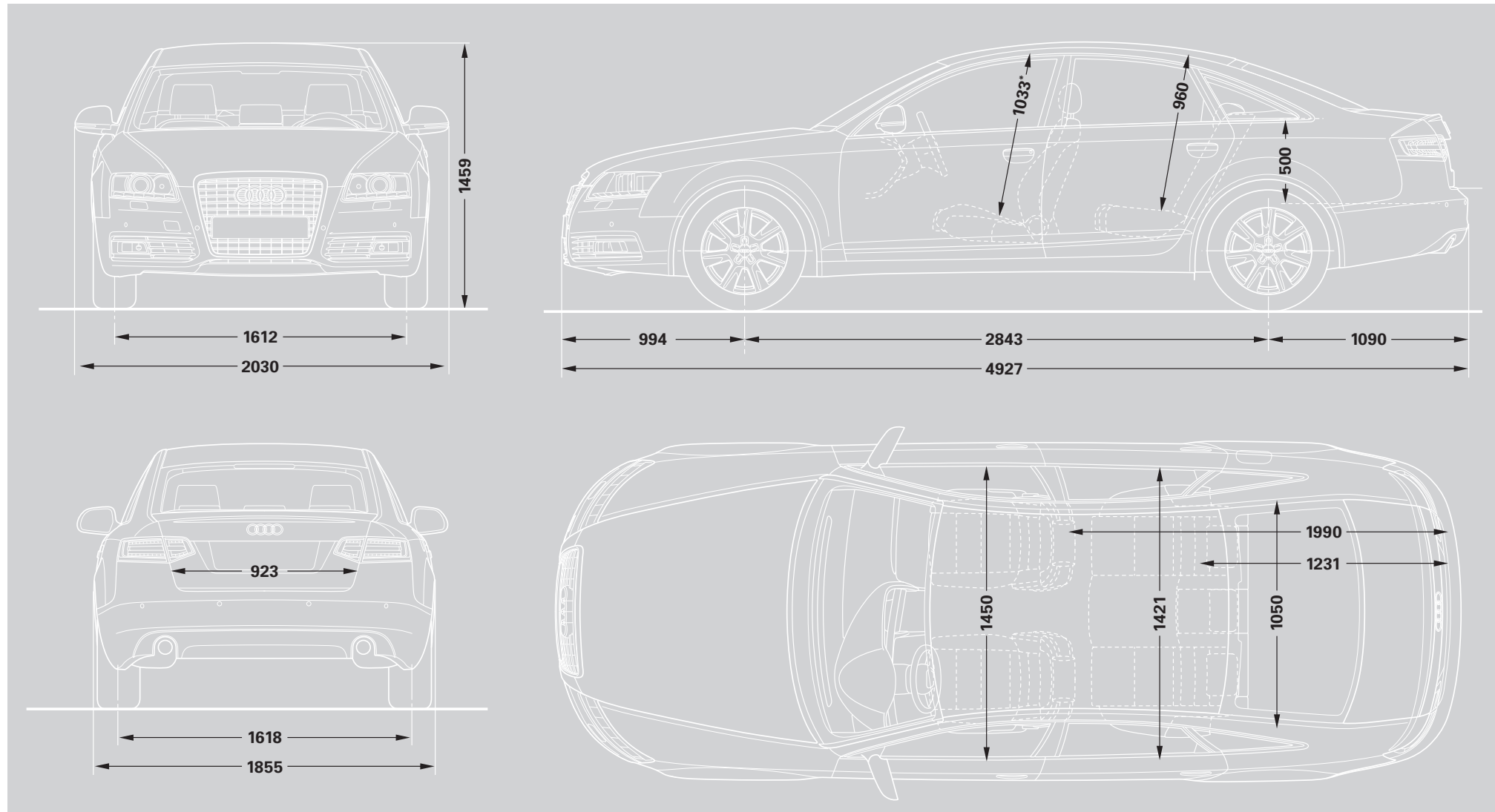

Dimensions were measured with vehicle at unladen weight. Turning circle approx 11.9m

Dimensions in millimetres

A6 Avant

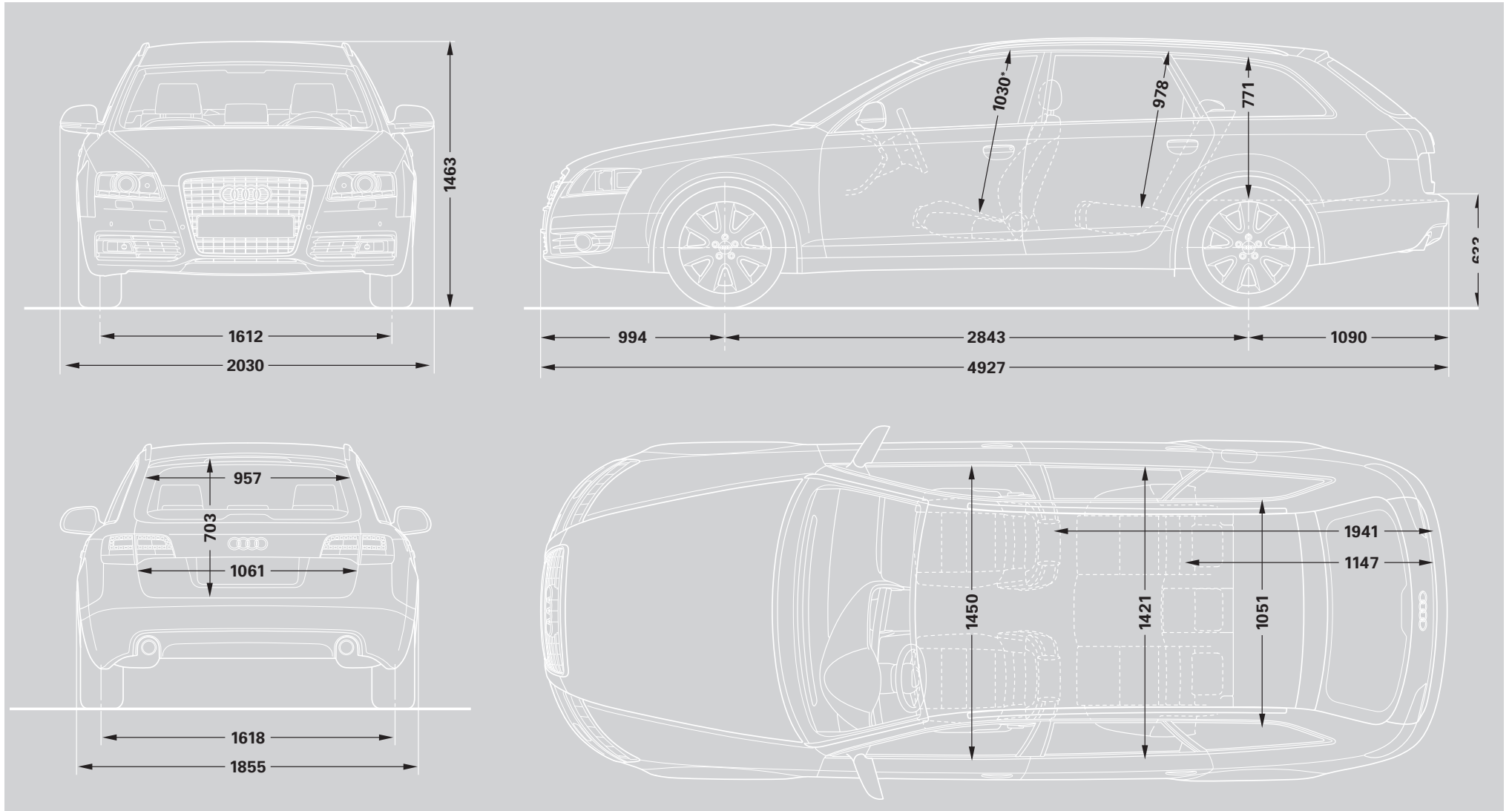

Dimensions were measured with vehicle at unladen weight. Turning circle approx 11.9m

Dimensions in millimetres

CO₂ data and information

CO₂ emissions-based Vehicle Excise Duty

Vehicle Excise Duty (Road Fund Licence) is based upon the amount of Carbon Dioxide (CO₂) a vehicle emits, measured in grams per kilometre (g/km). The DVLA has created seven categories:

Petrol and Diesel engines	
A – up to 100g/km	£0.00
B – 101 to 120g/km	£35.00
C – 121 to 150g/km	£120.00
D – 151 to 165g/km	£145.00
E – 166 to 185g/km	£170.00
F – 186 to 225g/km	£210.00
G – 226g/km or above	£400.00

CO₂ emission figures

The CO₂ emission figures quoted in the technical data section on pages 50-57 are based on a fully laden vehicle, including the driver, and the heaviest possible options configuration. Actual CO₂ emissions may be lower depending on options selected.

Servicing

Servicing tailored to your needs

Prior to the 2000 model year, almost all Audi models followed a traditional fixed Service Schedule similar to that of other major car manufacturers: a Lubrication Service every 10,000 miles and an Inspection Service every 12 months or 20,000 miles – whichever occurred sooner. Since then, Audi has introduced a more flexible maintenance system that works in accordance with how, where and how much an individual uses their car.

The two Servicing Regimes available are the conventional 'Inspection Service Regime' and the flexible 'LongLife Service Regime'. When you purchase a new car, we will recommend one of these regimes to you depending on your own individual driving style and journey-type. The tables below should give you an indication of which regime might be more appropriate for you.

With the LongLife Service Regime, on-board sensors continuously monitor the condition of the engine oil in terms of temperature, level and oil degradation. The monitoring system also checks mileage, brake-pad wear and battery condition. Using this information, the car's on-board

computer calculates its own maintenance interval, providing you with ample warning of a due Service via the 'distance to Service' display.

In practice, this means that every Audi gets the maintenance it needs, when it needs it. For companies and private owners alike, there are many advantages to the LongLife Service Regime. Longer service intervals mean lower maintenance costs, and thus lower whole-life costs. According to company car mileage monitored at Audi since the introduction of LongLife, petrol engines are typically achieving an average of at least 17,500 miles and diesel engines around 20,000 miles between services.

One of the factors that makes this kind of servicing regime possible is the advanced engineering and technology that goes into Audi engines. Furthermore, Audi use high-grade long-life oils such as Castrol SLX LongLife III, which are designed to withstand ageing and high loads without deterioration. Compared to conventional oils, these advanced-formulation oils also give exceptional levels of engine protection, are kinder to the environment and deliver average fuel savings of 2.7%.

Inspection Service Regime

	Vehicle usage:
Mileage	Less than 10,000* miles per annum.
Type of Journey	Mainly city/town centre driving. Short journeys.
Conditions	Frequent cold starts. High engine loading – e.g. frequent hill climbs, vehicle fully loaded, towing.
Driving style	Uneconomical – e.g. heavy acceleration, heavy braking, constant changes in speed, constant use of high revs, 'sporty' driving.
	Service intervals:
Oil-change Service	Every 10,000* miles/1 year
Interval Service	Every 20,000* miles/2 years
Interval Service Inspection	Every 40,000* miles/4 years

LongLife Service Regime

	Vehicle usage:
Mileage	More than 30 miles per day.
Type of Journey	Motorway and main road driving. Mainly longer distance journeys. Constant speeds.
Conditions	Normal engine loading – e.g. with little or no towing, with little or no hill climbs. Normal vehicle loading.
Driving style	Moderate acceleration, moderate braking, engine revs mainly below 3000.
	Service intervals:
Interval Service	Flexible to a maximum 20,000* miles/2 years
Interval Service Inspection	Every 40,000* miles/4 years

*Mileages are approximate as the Service Indicator system uses kilometres as its distance measurement.

Service by Design

At Audi, we believe our customers have the right to expect excellent service each and every time they make contact with us. To ensure that this happens, we have agreed a set of service standards with our Audi Centre network that governs the way they do business with you. These standards apply to both Sales and Aftersales, and we actively monitor our Centres to ensure that you receive the highest level of customer service. These service standards will ensure a consistent, stress-free experience whenever you are in contact with anyone representing the Audi brand.

Every Audi Centre will be open during the following hours:

Sales: 9am-6pm Monday to Friday
9am-5pm Saturday

Service: 8am-6pm Monday to Friday
8.30am-1pm Saturday

Sunday opening at local discretion.

Test drives

Whilst we cannot always have the desired demonstrator car ready immediately, we will confirm arrangements for a test drive within two working days (subject to status).

New Car delivery

Once we have confirmed a delivery date with you, we will keep you informed of progress. In the unlikely event of a delay, we will provide you with a courtesy car to minimise inconvenience and keep you mobile.

Delivery to any location within the UK

To maximise your Audi experience right from the first day of ownership, we will deliver your car to your preferred location – whether that's home or your place of work (subject to reasonable notice).

Every attention to detail

Your ownership experience starts with half a tank of fuel.

Quotation response

We are committed to answering any quotation request within 1 working day.

Training

We run a continuous training development programme for all our staff so that we consistently deliver a high-quality, professional service.

Formal complaints procedure

We have a complaints procedure designed to ensure any negative issue you raise with us is dealt with properly.

Courtesy cars

When your car is off the road, perhaps due to a scheduled service or MOT, we will offer you an Audi Courtesy Vehicle until yours is ready. We'll even collect from and deliver to your chosen location, keeping hassle to an absolute minimum.

All our courtesy cars are insured and fuelled

Upon collection or delivery, your courtesy car will have a minimum of a quarter of a tank of fuel; all we ask is that you replace any fuel used before returning it to us. On presentation of your driving licence, we will also insure the car free of charge.

Service bookings

If you do not require a courtesy car, we will service your Audi within a maximum of 5 working days. If you do choose to take a courtesy car, we will promise to service your vehicle within a maximum of 10 working days.

Cleaning

When your car comes to our workshop, we will wash and vacuum it at no extra cost.

No hidden charges

You will be consulted before we carry out any necessary work on your vehicle, and anything charged for will be itemised on your bill. No extra work will be undertaken without your permission.

A personal service

All work will be done by a named Audi technician, to whom you can personally direct questions or requests should you need to.

Environmental commitment

We promise to dispose of all non-biodegradable materials from your vehicle in a responsible manner.

Pricing information

Pricing

Prices and specifications given are correct at the time of printing. Always check details with your Audi Centre, as Audi policies are continually developing.

We reserve the right to change prices or specifications at any time.

All prices are subject to VAT, currently charged at 17.5%.

Delivery charges and numberplates are not included in the vehicle price.

Delivery charge	£469.36
Numberplates	£20.00
VAT	£85.64
Total	£575.00

Audi Roadside Assistance

Your new car comes complete with free roadside assistance and recovery across the UK provided by RAC Motoring Services. Your 24 months' free cover can be extended for a further year free-of-charge, provided that your vehicle is serviced and, if necessary, repaired by an Authorised Audi Centre or Audi-Authorised Repairer in accordance with the manufacturer's instructions.

Audi Customer Care

Every new Audi benefits from the comprehensive Audi Customer Care Package, which comprises:

- ▶ A 3-year Audi warranty, which covers you for unlimited mileage in the first 2 years of ownership, with a full mechanical and electrical warranty which covers you for up to 60,000 miles in the 3rd year
- ▶ A 3-year paint warranty
- ▶ A 12-year anti-corrosion warranty
- ▶ Up to 3 years' UK roadside assistance and recovery.

This package, together with Audi variable Service intervals, offers a combination unmatched by any other major manufacturer. Contact your Audi Centre for full details.

Audi Tax-Free Sales

If you are entitled to purchase a vehicle free of VAT, normally through Military or Diplomatic privilege, please contact your local Audi Centre for full details.

Should you have any difficulty obtaining the information you require, please call Freephone 0800 585878.

Audi Finance

Audi Finance specialise in providing funding solutions for Audi drivers. Whether your Audi is for private or business use, there are a range of funding options to choose from.

Below is our full range of finance products.

- ▶ Solutions – a Personal Contract Plan
- ▶ Hire Purchase
- ▶ Lease Purchase
- ▶ Finance Lease
- ▶ Contract Hire

With all our finance products, you can choose one of our fixed-cost maintenance plans, which are designed to help you budget accurately.

No matter what Audi model you choose, your local Audi Centre can provide you with a personalised quote which could fit your budget and motoring needs.

Audi Finance is a trading name of Volkswagen Financial Services (UK) Limited. An offer of finance depends on certain conditions. Available to people over 18 in the UK only.

Audi Insurance

Competitive comprehensive motor insurance designed specially for Audi drivers. All new Audi models come with complimentary seven-day cover upon request – we'll email a cover note directly to your Audi Centre, enabling them to tax your car easily. This way, you can drive straight out of the showroom. Taking out an annual policy is easy and can begin as soon as your free seven-day cover expires.

For more information, contact your local Audi Centre. Alternatively, call 0800 051 3146 for a quote and to receive 7 days' complimentary cover for your new Audi.

Audi Insurance is underwritten and administered by Zurich Insurance Company.

Notes

Audi UK

Customer Services
Selectapost 29
Sheffield
S97 3FG
0800 699888
www.audi.co.uk

Specifications and
prices subject to
change without notice.

© Audi (UK)

Printed in the UK
Edition 1. 08/08
2009 Model Year



Mixed Sources
Product group from well-managed
forests and other controlled sources

Cert no. TT-COC-002327
www.fsc.org
© 1996 Forest Stewardship Council