



The new Audi Q5
Pricing and Specification Guide
Valid from September 2008



A User's Guide

This guide has been designed to help you tailor and price your Audi Q5 quickly and logically. At the back of this guide, you will also find information on CO₂ emissions-based vehicle excise duty and other services offered by Audi, including Finance and Insurance.

Table of content

	Page number
Introduction	
The Audi Q5	
Engines	6
Transmission	7
quattro®	8
Model details and prices	
SE models	10
S line models	12
Colour and upholstery	
Paint finishes	14
Upholstery options	16
Colour and trim guide	20
Inlays	22
Options	
Wheels, tyres and suspension	24
Packages	28
Audio and communication	30
Seats	32
Steering wheels	33
Safety and security	34
Interior equipment	36
Exterior equipment	38
Technical details	
Technical data	40
Dimensions	42
Additional information	44

The new Audi Q5

The Audi Q5 was built to break the mould. With its spacious yet streamlined body, it's no typical SUV, combining the poise and athleticism of a coupé with the practicality and space of a much larger car. Its flowing shape also incorporates some other attractive features, such as imposing 18-inch alloy wheels and five-link front suspension for superb handling. And then there's the range of advanced optional equipment on offer, including our latest HDD-based Satellite Navigation system.

Behind all this lies the remarkable road-holding of quattro® all-wheel-drive, the technology that underpins our most historic achievements on the rally circuit. And it comes with a choice of powerful TFSI or TDI engines, which use direct fuel injection for increased efficiency and better performance. A new 7-speed S tronic gearbox is also available to provide seamless, lightning-fast gear changes.

A design composed of smooth, sweeping lines, deliberately avoiding the 'boxy' SUV shape we've come to expect. A practical, spacious car that's nevertheless built for driving pleasure. In fact, with its class-leading drag coefficient of just 0.33, it's quite simply the most streamlined and aerodynamic car in its class. See it for yourself over the following pages.



Engines

Petrol

TFSI® is a unique Audi innovation. It combines turbocharging with the FSI® technology originally developed for the Le Mans 24-hour endurance race to deliver increased power and torque, as well as enhanced fuel efficiency. Precisely the right amount of fuel and air are injected directly into the combustion chambers, 'unthrottling' the engine and enabling it to 'breathe' more easily. At the same time, electronics monitor the engine load and adjust the injection process. The result – reduced heat-loss and increased output, with around a 15% reduction in fuel consumption and significantly lower exhaust emissions. Ideal for someone who's looking for an uncompromising, exhilarating drive.

Diesel

We introduced TDI® to the roads in 1989, marking a departure from the noisy, fuel-thirsty diesel engines of the past. And since then, we've continuously refined it, recently developing common-rail technology for even more efficiency and power. Under this system, a series of piezo injectors use electrical charge to precisely control the amount of fuel injected into the engine. As well as reducing noise, this allows combustion to happen at a lower temperature and uses less oxygen, which in turn reduces emissions.

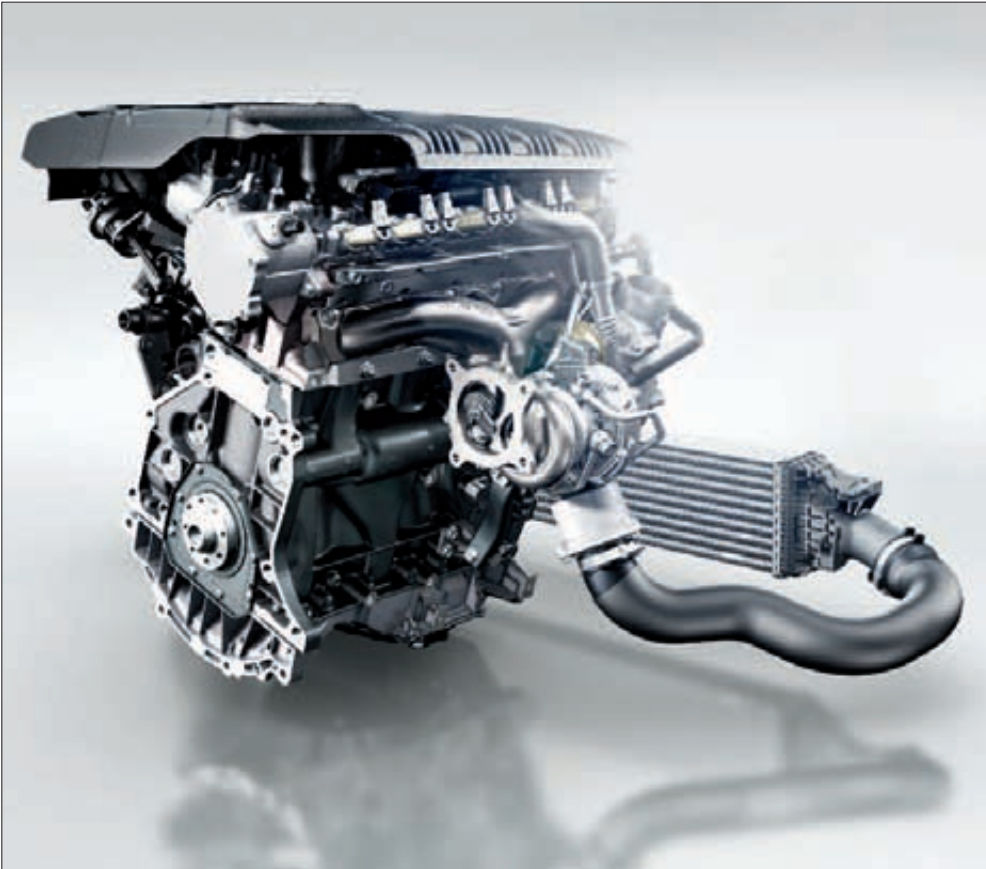

Transmission

S tronic®

The revolutionary 7-speed S tronic gearbox combines sporty driving with the convenience and smooth, uninterrupted power of an automatic transmission. The technical basis of S tronic is the double clutch. This consists of two lubricated plates with hydraulically-regulated contact pressure. It means that S tronic works almost as two separate systems: one engaging the odd-numbered gears, the other the even-numbered gears, enabling gearshifts to be made

in a fraction of a second, with no disruption to the power flow. So with S tronic, depending on how the mood takes you, you can either allow gear-changes to take place automatically or, for a sportier driving style, operate the system using the gear lever or the optional steering wheel shift-paddles. The choice is yours.



quattro

Permanent all-wheel-drive

It's the technology that has given Audi the edge on the racetrack ever since it was first introduced over 25 years ago – a technology that delivers ultimate control whilst enhancing the sporty characteristics which make the Audi Q5 so thrilling to drive. It's called quattro® permanent all-wheel-drive. The principle is simple: in the same way that four brakes ensure better deceleration, four permanently-driven wheels deliver better acceleration and road-holding, pushing or pulling

the car as needed, for a driving experience that's both dynamic and safe. In the Audi Q5, asymmetric-dynamic torque distribution continuously distributes drive power between the front and the rear axles depending on weather conditions, road surface and gradient, which increases flexibility for an enhanced, sportier drive.

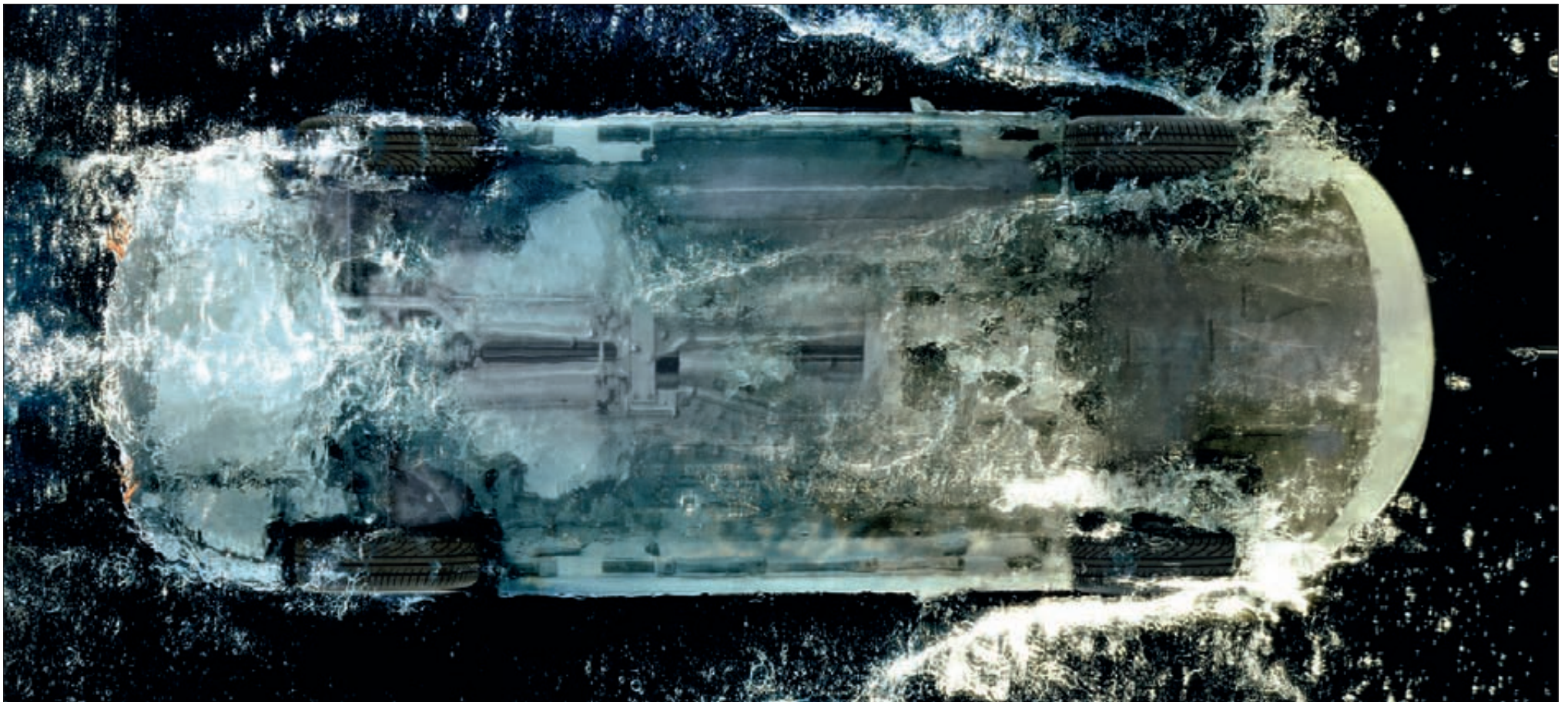

Images shown are for illustration purposes only and do not necessarily depict UK specification.



SE model equipment

All Audi Q5 models have the following items of equipment:

Wheels, tyres and suspension

18 x 8J '10-spoke-V' alloy wheels with 235/60 R18 tyres and locking wheel bolts
Tyre mobility system

Audio and communication

Audi Concert radio – CD player with MP3 compatibility, 6.5" colour centre console screen
Audi Sound System – 10 high-performance loud speakers (180W) and six-channel amplifier

Seats

Milano leather upholstery
Split-folding rear seat

Safety and security

Anti-theft device – Thatcham category 1 approved
Auto-dimming rear-view mirror
Automatic headlight operation
Automatic windscreen wiper operation

Electromechanical parking brake
First-aid kit
Front and rear fog lights
Front and rear ISOFIX seats with airbag de-activation switch for front passenger seat
Halogen headlights with daytime-running lights
Hill Descent Control with Off-road Electronic Stability Programme (ESP)
Rear acoustic parking system
Tool kit and car jack
Warning triangle

Interior equipment

1-zone climate control (except 3.0 TDI)
4-spoke multi-function leather steering wheel
Aluminium inlays
Deluxe 3-zone climate control with separate air distribution and digital temperature displays for driver, front passenger and rear passenger compartment (3.0 TDI only)
Driver's Information System (DIS) in colour

Front and rear electric windows
Front and rear floor mats
Front centre armrest including 12-Volt socket
Servotronic speed-related power-assisted steering

Exterior equipment

Aluminium roof rails with roof bar detection (automatically adjusts the ESP to react to the higher centre of gravity when roof bars are in place)
Aluminium window trims framing the exterior side windows
Door mirrors – electrically adjustable and heated
Full body-coloured bumpers
High-gloss black painted grille on 3.0 TDI. All other models come with Stone grey finish grille
Rear spoiler
Roof bars



18 x 8J '10-spoke-V' alloy wheels



Aluminium inlays



Door mirrors – electrically adjustable and heated

SE model prices

Petrol

Engines	Power	Transmission	Basic RRP	Total RRP ^{inc. VAT}	Recommended OTR
2.0 TFSI quattro®	211PS	7-speed S tronic®	£26,042.55	£30,600.00	£31,440.00

Diesel

Engines	Power	Transmission	Basic RRP	Total RRP ^{inc. VAT}	Recommended OTR
2.0 TDI quattro®	170PS	6-speed manual	£24,808.51	£29,150.00	£29,950.00
3.0 TDI quattro®	240PS	7-speed S tronic®	£29,404.26	£34,550.00	£35,390.00



Recommended On-The-Road (OTR) retail prices include: delivery charge, half a tank of fuel, number plates at £575.00 (inc. VAT), Road Fund Licence (which may vary depending on model/transmission – see page 44 for details) and first registration fee at £55.00.

RRP – Recommended Retail Price.
Images shown are for illustration purposes only and do not necessarily depict UK specification.

S line model equipment

In addition to SE model equipment:

Basic RRP	Total RRP <small>inc. VAT</small>
£1,829.79	£2,150.00

Wheels, tyres and suspension

19 x 8J '5-spoke' alloy wheels with 235/45 R19 tyres and locking wheel bolts

S line Sports suspension (not lowered)

Seats

Front Sports seats in Milano leather with electric lumbar support (S line embossed)

Interior equipment

Black headlining

Matt-brushed aluminium inlays

S line 3-spoke leather multi-function steering wheel (with gear shift paddles for S tronic)

S line sill plates and aluminium loading strip for the boot

Exterior equipment

Chrome fog light surround

Chrome-plated exhaust tailpipe surrounds (4-cylinder models only)

Diffuser in Platinum grey optic

Rear LED lights

S line exterior styling package including:

- ▶ S line badges on front wings
- ▶ S line front bumper
- ▶ S line rear diffuser
- ▶ S line side skirts
- ▶ S line grille with chrome vertical bars

Xenon headlights with automatic headlight-range adjustment, headlight washers and LED daytime-running lights



19 x 8J '5-spoke' alloy wheels



S line 3-spoke leather multi-function steering wheel



Matt-brushed aluminium inlays

S line model prices

Petrol

Engines	Power	Transmission	Basic RRP	Total RRP ^{inc. VAT}	Recommended OTR
2.0 TFSI quattro®	211PS	7-speed S tronic®	£27,872.34	£32,750.00	£33,590.00

Diesel

Engines	Power	Transmission	Basic RRP	Total RRP ^{inc. VAT}	Recommended OTR
2.0 TDI quattro®	170PS	6-speed manual	£26,638.30	£31,300.00	£32,100.00
3.0 TDI quattro®	240PS	7-speed S tronic®	£31,234.04	£36,700.00	£37,540.00



S line trim with optional 20 x 8.5J '7-double-spoke' design alloy wheels

Recommended On-The-Road (OTR) retail prices include: delivery charge, half a tank of fuel, number plates at £575.00 (inc. VAT), Road Fund Licence (which may vary depending on model/transmission – see page 44 for details) and first registration fee at £55.00.

RRP – Recommended Retail Price. Images shown are for illustration purposes only and do not necessarily depict UK specification.

Paint finishes

Standard colours

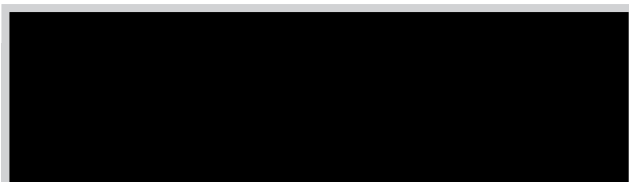

Brilliant black

A2

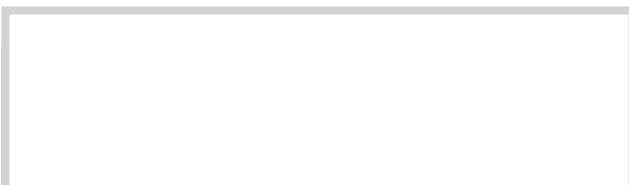

Ibis white

T9

Optional colours

Basic RRP	Total RRP <small>inc. VAT</small>
£510.64	£600.00



Tungsten grey, metallic

1J



Garnet red, pearl effect

9C



Dakar beige, metallic

9X



Lava grey, pearl effect

1R

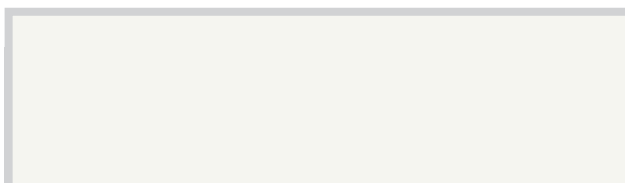

Ice silver, metallic

P5

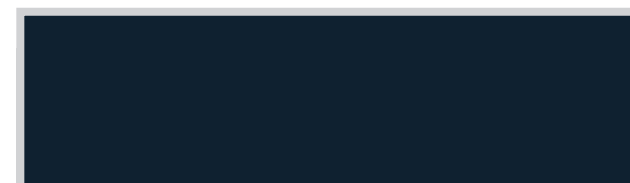

Meteor grey, pearl effect

X5

S line additional colours

Basic RRP	Total RRP ^{inc.} _{VAT}
£510.64	£600.00

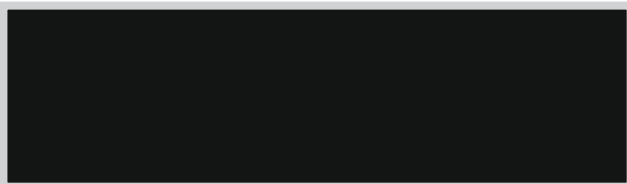

Phantom black, pearl effect

L8



Stratos blue, pearl effect

X4



Quartz grey, pearl effect

Q4

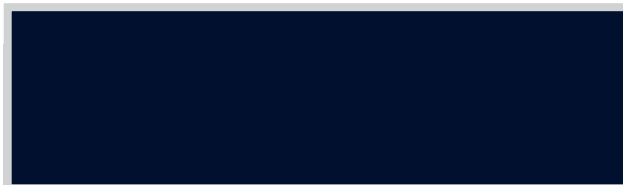

Deep sea blue, pearl effect

8A



Daytona grey, pearl effect

6Y







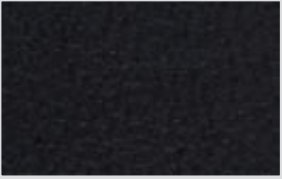

Monza silver, metallic

U7

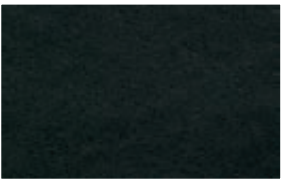

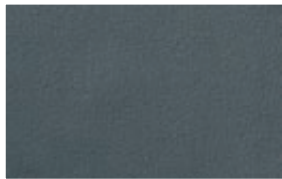





Upholstery

Standard seats

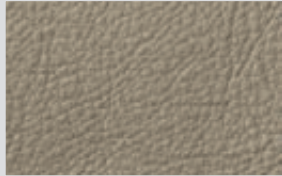
			SE	S line	Basic RRP	Total RRP ^{inc. VAT}
			S	-	No charge	No charge
Milano leather, Black CA	Milano leather, Light grey RD	Milano leather, Cardamom beige RG				
						
Fine Nappa leather, Black CA	Fine Nappa leather, Star silver RC/RF	Fine Nappa leather, Cinnamon RE	•	-	£340.43	£400.00
						
Fine Nappa leather, Light grey RD	Fine Nappa leather, Cardamom beige RG					

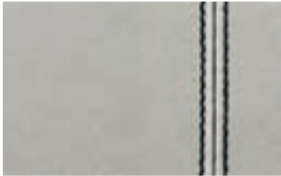

Upholstery

Sports seats

			SE	S line	Basic RRP	Total RRP ^{inc.} _{VAT}
			•	—	£340.43	£400.00
Milano leather, Black CA	Milano leather, Light grey RD	Milano leather, Cardamom beige RG				
			•	—	£680.85	£800.00
Fine Nappa leather, Black/Black CA	Fine Nappa leather, Star silver/Black ET/EW	Fine Nappa leather, Cinnamon/Black EU				
						
Fine Nappa leather, Light grey/Black EV	Fine Nappa leather, Cardamom beige/Pimento beige EY					

Upholstery

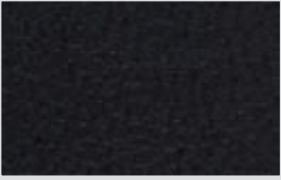
S line Sports seats

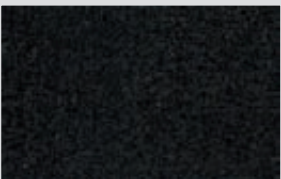
		SE	S line	Basic RRP	Total RRP ^{inc. VAT}
	QE	-	S	No charge	No charge
	QE	-	•	No charge	No charge
	QF	-	•	No charge	No charge
	QE	-	•	£297.87	£350.00



Colour and trim guide

To help you choose the right interior for your Audi Q5, please use the guide below which shows the carpet, dashboard and headlining colours that have been matched to your chosen upholstery.

Standard seats – Interior trim colours

Order code	Upholstery	Carpet	Dashboard	Headlining	Milano leather (PEB)	Fine Nappa leather (PEC)
CA	Black	Black	Black/Black	Light grey	●	●
RC	Star silver	Black	Black/Black	Light grey	–	●
RE	Cinnamon	Black	Black/Black	Light grey	–	●
RD	Light grey	Graphite grey	Graphite grey/Graphite grey	Light grey	●	●
RF	Star silver	Graphite grey	Graphite grey/Graphite grey	Light grey	–	●
RG	Cardamom beige	Pimento beige	Pimento beige/Pimento beige	Linen beige	●	●

Sports seats – Interior trim colours





Order code	Upholstery	Carpet	Dashboard	Headlining	Milano leather (PEL)	Fine Nappa leather (PEE)
CA	Black*	Black	Black/Black	Light grey	●	●
RD	Light grey	Graphite grey	Graphite grey/Graphite grey	Light grey	●	–
RG	Cardamom beige	Pimento beige	Pimento beige/Pimento beige	Linen beige	●	–
ET	Star silver with Black stitching	Black	Black/Black	Light grey	–	●
EU	Cinnamon with Black stitching	Black	Black/Black	Light grey	–	●
EV	Light grey with Black stitching	Graphite grey	Graphite grey/Graphite grey	Light grey	–	●
EW	Star silver with Black stitching	Graphite grey	Graphite grey/Graphite grey	Light grey	–	●
EY	Cardamom beige with Pimento stitching	Pimento beige	Pimento beige/Pimento beige	Linen beige	–	●

S line seats – Interior trim colours

Order code	Upholstery	Carpet	Dashboard	Headlining	Alcantara/Leather (N7K)	Milano leather (N1Y)	Fine Nappa leather (N2R)
QE	Black	Black	Black/Black	Black	●	●	●
QF	Black/Silver*	Black	Black/Black	Black	●	–	–

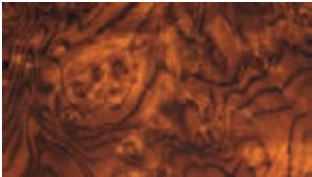

Inlays

Order code			SE	S line	Basic RRP	Total RRP ^{inc. VAT}
5MF		Aluminium silver	S	-	No charge	No charge
5TK		Ash, almond beige	•	-	£170.21	£200.00
7TL		Brown ash, natural	•	-	£170.21	£200.00
5TS		Walnut, natural	•	-	£170.21	£200.00
5TG		Matt-brushed aluminium	-	S	No charge	No charge
5TL		Piano black	-	•	£255.32	£300.00



Wheels, tyres and suspension

Order code	SE	S line	Basic RRP	Total RRP ^{inc. VAT}
PRS 18 x 8J '6-spoke Parabola' design alloy wheels with 235/60 R18 tyres	•	-	£170.21	£200.00
PRL 19 x 8J '5-arm' design alloy wheels with 235/55 R19 tyres	•	-	£425.53	£500.00
PRT 19 x 8J '10-spoke Star' design alloy wheels with 235/55 R19 tyres	•	-	£510.64	£600.00



18 x 8J '6-spoke Parabola' design alloy wheels



19 x 8J '5-arm' design alloy wheels



19 x 8J '10-spoke Star' design alloy wheels

Wheels, tyres and suspension

Order code		SE	S line	Basic RRP	Total RRP ^{inc. VAT}
PRD	20 x 8.5J '5-spoke Star' design alloy wheels with 245/45 R20 tyres*	•	-	£1,021.28	£1,200.00
PQ7	20 x 8.5J '5-double-spoke Off-road' design alloy wheels with 255/45 R20 tyres* (only available in conjunction with Off-road pack (VJ2))	•	-	£425.53	£500.00
PQF	20 x 8.5J '7-double-spoke' design alloy wheels with 255/45 R20 tyres*	• -	- •	£1,021.28 £425.53	£1,200.00 £500.00



20 x 8.5J '5-spoke Star' design alloy wheels



20 x 8.5J '5-double-spoke Off-road' design alloy wheels



20 x 8.5J '7-double-spoke' design alloy wheels

*Please note, this option includes a small extension to the wheel arches.
On S line trims the wheel arch is matt black, on SE models it matches the colour of the contrasting bumpers.

Wheels, tyres and suspension

Order code		SE	S line	Basic RRP	Total RRP ^{inc. VAT}
PQS	20 x 8.5J '20-spoke' design two-piece alloy wheels with 255/45 R20 tyres*	• -	- •	£1,021.28 £425.53	£1,200.00 £500.00
3F1	Collapsible spare wheel	•	•	£93.62	£110.00



20 x 8.5J '20-spoke' design two-piece alloy wheels

Wheels, tyres and suspension

Order code		SE	S line	Basic RRP	Total RRP ^{inc. VAT}
2H1 1BL	Audi drive select with damper control. The optional damper control system makes it possible to set suspension tunings individually. Adjustable hydraulic dampers alter the damper characteristics separately for each wheel	•	•	£851.06	£1,000.00
2H1 1N7	Audi drive select with dynamic steering. This new technology makes driving significantly more agile under everyday conditions, increasing directional stability and precision at high speeds and in demanding driving situations	•	•	£851.06	£1,000.00
2H1 1BL 1N7	Audi drive select – full package. Includes both damper control and dynamic steering	•	•	£1,446.81	£1,700.00



Control panel for Audi drive select

Packages

Opting for a package allows you to take advantage of several specification options at a greatly reduced price.

Order code		SE	S line	Basic RRP	Total RRP ^{inc. VAT}
VJ2 F05	Off-road styling pack – including front and rear lower bumper spoilers with stainless steel under-body protection in off-road design, wheel arch extensions in Stone grey, front grille with vertical chrome struts and 19" 5-arm Off-road design alloys	•	–	£2,553.19	£3,000.00
PNG 7X4 4E9	Technology pack – including HDD Satellite Navigation/MMI High, Audi parking system plus and electric tailgate	•	•	£1,697.87	£1,995.00
WTG	Luggage pack – including folding front-passenger seat, rear bench seat plus, net partition, rail system with load-securing set and reversible luggage-compartment mat (not available with lumbar support or S line)	•	–	£404.26	£475.00
QE5	Storage pack – includes nets on the back of the front seats, storage compartment under the front seats (only under passenger seat if memory function is fitted), multi-fastening point in passenger footwell, luggage spider-net for boot floor, net under rear parcel shelf and lockable glove compartment	•	•	£102.13	£120.00



19 x 8J '5-arm Off-road wheels (part of Off-road styling pack)



Off-road styling pack with optional 20" '5-double-spoke Off-road' design alloy wheels



Audio and communication

Order code		SE	S line	Basic RRP	Total RRP ^{inc. VAT}
8UD	Audi Concert Radio. Single CD with MP3 compatibility and colour centre console screen	S	S	No charge	No charge
8UM	Audi Symphony radio, with front-loading MP3-compatible 6-CD changer and colour centre console screen	•	•	£191.49	£225.00
UF7	Audi Music Interface (AMI). Universal connection for use with stereo audio sources and Apple iPod generation 4 onwards (iPod, iPod classic, iPod mini, iPod nano, iPod photo, iPod video, iPod touch). Provides intuitive control through the audio system and multi-function steering wheel. It also replicates the iPod display on the audio screen, including track titles. The interface provides power. An adapter cradle is required at additional cost. Please consult your Audi Centre for details. Only in combination with HDD Satellite Navigation	•	•	£170.21	£200.00
9VK	Bang & Olufsen Sound System. Designed specifically for the Audi Q5, providing surround-sound reproduction with dynamic noise compensation, 14 high-performance loud speakers (505 Watt) and 10-channel amplifier	•	•	£446.81	£525.00
7D1	CD changer and DVD player. 6-CD changer located in the glove box and single CD/DVD slot in centre console	•	•	£297.87	£350.00
QV3	Digital radio. Reception integrated into MMI. Receives digitally-transmitted radio stations in addition to the range of analogue stations (FM, MW, LW). Reception dependent on local digital network	•	•	£255.32	£300.00
PNG	HDD Satellite Navigation including MMI High. 3rd generation MMI system including single CD/DVD player, 2 FM tuners, high resolution (800x400) 7" colour TFT display, 2 SD card readers and 40GB hard drive, 10GB of which can be used to store up to 4,000 songs. HDD Navigation functionality includes advanced speech recognition, 3D and topographical mapping display and advanced 3D building display	•	•	£1,659.57	£1,950.00

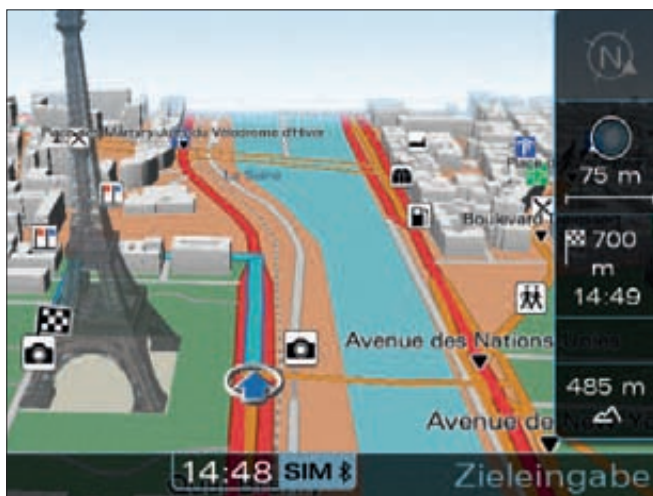

HDD Satellite Navigation 3D building display



MMI High media options menu



Control panel for HDD Satellite Navigation and MMI High

Audio and communication

Order code		SE	S line	Basic RRP	Total RRP ^{inc. VAT}
PT5	Mobile telephone preparation – Low. Located in front centre armrest. Uses Bluetooth interface or cradle to connect to your Audi Q5, including roof aerial for optimal reception. A phone cradle is required to charge your phone at extra cost. Please consult your Audi Centre for details of phone compatibility	•	•	£382.98	£450.00
9ZW	Mobile telephone preparation – High. Uses Bluetooth interface with no physical connection to your Audi Q5. Operated via the optional MMI High system and integrated telephone voice-control system, including roof-mounted aerial for optimal reception. Must be combined with HDD Satellite Navigation with MMI High. Please note that your mobile phone must have Bluetooth SIM-Access Profile facility. For a list of compatible phones, please consult your local Audi Centre	•	•	£553.19	£650.00
PT4	Mobile telephone preparation – High, with Privacy Handset. The cordless handset allows passengers to make private calls, provides remote control of the telephone functions as well as convenient SMS text message function. The handset is charged from a docking station integrated into the front centre armrest	•	•	£808.51	£950.00
9WM	Rear Seat Entertainment System, fitted to the back of the Audi Q5 front seats. The package includes 2 detachable DVD players/monitors (supplied by Audi Genuine Accessories) that can be used both inside and outside the Audi Q5. The driver and passenger front seats are fitted with the mountings and power connections for the DVD players for when the entertainment system is used inside the Audi Q5. Usage outside of the Audi Q5 is via a rechargeable battery or mains power connection, which is included in the package. Includes individual remote controls	•	•	£846.81	£995.00
QU1	TV reception (analogue and digital) and DAB digital radio (only in combination with HDD Satellite Navigation)	•	•	£978.72	£1,150.00
QV9	TV reception (analogue and digital) (only in combination with HDD Satellite Navigation)	•	•	£723.40	£850.00

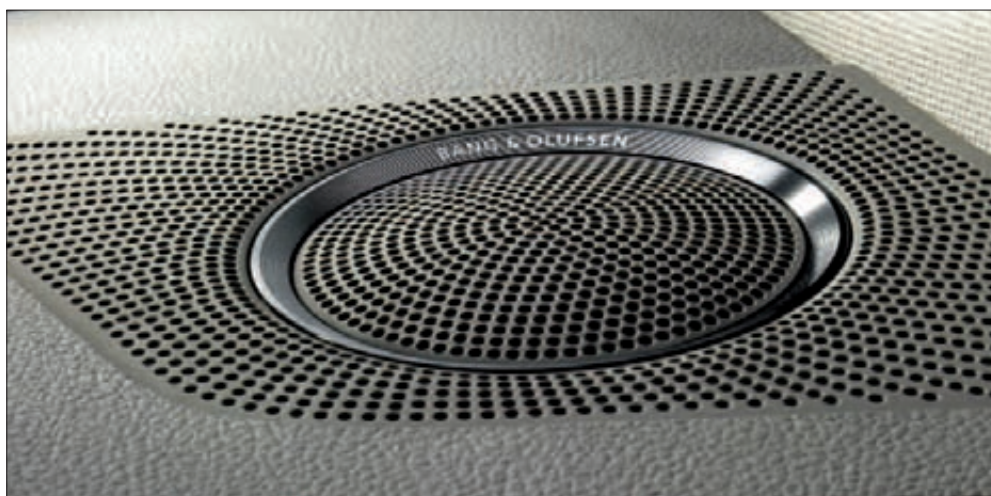

Bang & Olufsen Sound System



Mobile telephone preparation – High

Seats

Order code		SE	S line	Basic RRP	Total RRP ^{inc. VAT}
Q2N	Front passenger seat – folding. Not available with lumbar support or S line	•	–	£106.38	£125.00
PS8	Climate comfort seats – folding. Climate-controlled front seats can be heated or cooled according to the driver and passenger's requirements. Includes electrically adjustable front seats with lumbar support and memory function for driver's seat				
9AQ		•	–	£1,936.17	£2,275.00
PV3		•	–	£1,553.19	£1,825.00
4A3					
PV1	Electrically adjustable front seats. With adjustment for height, fore and aft position, backrest angle and lumbar support for driver and front passenger seats	•	•	£565.96	£665.00
PV3	Electrically adjustable front seats with memory function and lumbar support. Also includes electrically adjustable, heated, folding and auto-dimming door mirrors, with memory function	•	•	£923.40	£1,085.00
6XL					
7P1	Electric lumbar support for front seats, with horizontal and vertical adjustment	•	S	£195.74	£230.00
4A3	Heated front seats. Individually controlled seat base and bolster heating with variable temperature adjustment	•	•	£234.04	£275.00
4A4	Heated front and rear seats. Individually controlled seat base and bolster heating with variable temperature adjustment	•	•	£425.53	£500.00
5KA	Rear bench seat plus, allows both the 1/3 and 2/3 sections of the rear bench seat to be independently adjusted by 100mm front and back. Also includes a through-load facility with an integral centre armrest containing a cup holder	•	•	£144.68	£170.00



Electric front seats



Rear bench seat plus

Steering wheels

Order code		SE	S line	Basic RRP	Total RRP ^{inc. VAT}
1XW	3-spoke Sports multi-function steering wheel	•	–	£85.11	£100.00
1XX	3-spoke Sports multi-function steering wheel with gear shift paddles (for S tronic transmissions only)	•	–	£212.77	£250.00



Safety and security

Order code		SE	S line	Basic RRP	Total RRP ^{inc. VAT}
UH2	Audi hill-hold assist. Automatically activates electromechanical parking brake when stationary	•	•	£38.30	£45.00
PU1	Audi lane assist. Uses a discreet camera mounted at the top of the windscreen to monitor the road ahead. The driver is warned via a vibration of the steering wheel if the vehicle is about to exit the lane unintentionally (only available in combination with a 4-spoke steering wheel. S line badging and stitching are not available)	•	•	£340.43	£400.00
7X4	Audi Parking System Plus. Aids parking by acoustically and graphically indicating distances to obstacles in front of and behind your Audi Q5	•	•	£272.34	£320.00
7X8	Audi Parking System Advanced. Aids parking by acoustically and visually indicating (with guiding lines) distances to obstacles in front of and behind your Audi Q5. Measured by ultrasonic sensors and camera integrated discreetly in the boot handle	•	•	£570.21	£670.00

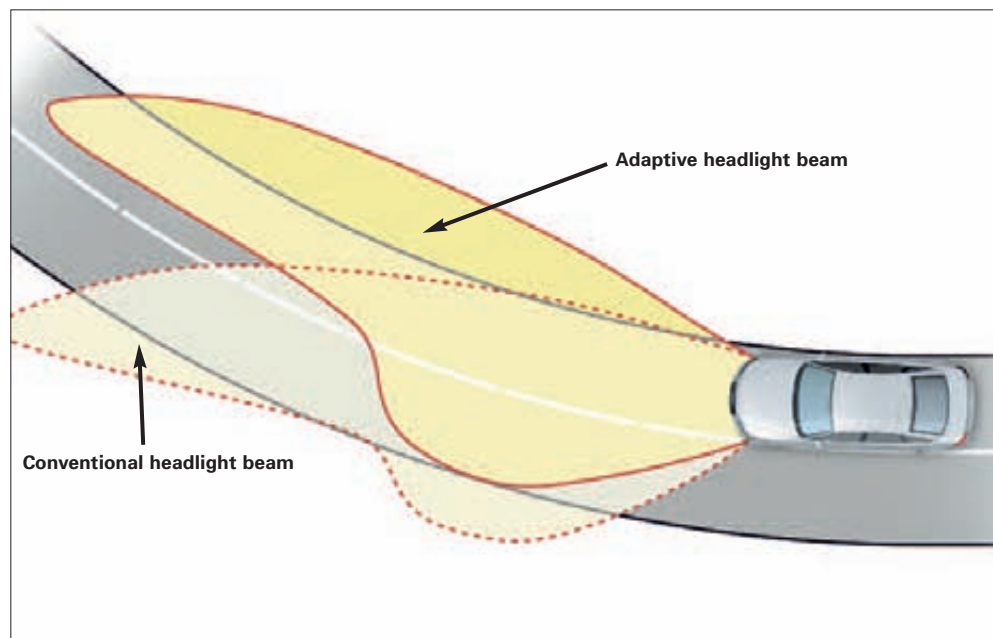

Adaptive lights



Audi Parking System Advanced

Safety and security

Order code		SE	S line	Basic RRP	Total RRP ^{inc. VAT}
7Y1	Audi side assist. Aids the driver when changing lane. Audi Side Assist monitors the area behind your Q5, using radar sensors located discreetly in the rear bumper to inform the driver via a visual warning signal in the door mirror if there is a vehicle in their blind spot or approaching quickly from behind. The system is activated via a button on the driver's door	•	•	£382.98	£450.00
8X1	Headlight washers	•	S	£191.49	£225.00
8N7	High-beam assist. Automatically adjusts headlights from high-beam to dipped-beam when another vehicle is approaching	•	•	£85.11	£100.00
4X4	Rear side airbags	•	•	£212.77	£250.00
7K6	Tyre pressure monitor display	•	•	£63.83	£75.00

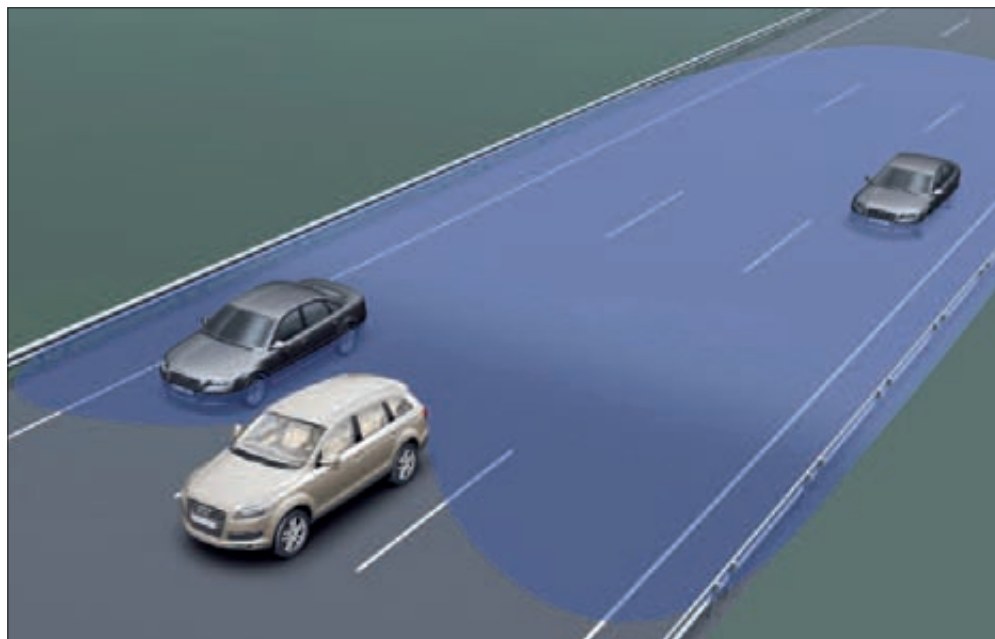

Audi side assist



Cruise control

Interior equipment

Order code		SE	S line	Basic RRP	Total RRP ^{inc. VAT}
9AQ	3-zone climate control with separate air distribution and digital temperature displays for driver, front passenger and rear passenger compartment (standard on 3.0 TDI models)	•	•	£382.98	£450.00
8T4	Adaptive cruise control. Automatic distance regulation, using radar sensors to maintain required distance by braking and accelerating. Four programmes (distance 1 to distance 4) set via steering column controls of the cruise control system (only in combination with HDD Navigation)	•	•	£936.17	£1,100.00
4F2	Advanced key. Access and authorisation system that works through automatic data exchange between key and vehicle, allowing the driver to keep their car key in their pocket or bag at all times. To unlock and open, simply lift the exterior door handle. The door is locked by pressing the button on the handle. Pressing the start/stop button integrated in the centre console starts and stops the engine	•	•	£426.53	£500.00
KT1	Climate cup holder. Allows cup holder to be cooled to 3°C or heated to 58°C. Operated via two control switches (one for hot and one for cold) positioned behind the cup holder. Located between driver and front passenger	•	•	£85.11	£100.00
8T1	Cruise control	•	•	£187.23	£220.00
VC1	Garage door opener (Homelink*). Programmable radio-operated remote control for compatible doors/gates. Control buttons integrated in the roof module at the front	•	•	£148.94	£175.00
6NQ	Headlining in black cloth	•	S	£187.23	£220.00
6NN	Headlining in Alcantara. Must be combined with interior light pack (colour dependent on upholstery choice – please see page 20 for details)	•	•	£851.06	£1,000.00
6NS	Headlining in black Alcantara. Must be combined with interior light pack	•	•	£851.06	£1,000.00

Interior equipment

Order code		SE	S line	Basic RRP	Total RRP ^{inc. VAT}
QQ1	Interior light package. Includes reading lights at rear, illuminated vents, internal door controls and vanity mirrors, active door reflectors, entrance lighting, footwell lighting at front and illuminated glove compartment	•	•	£136.17	£160.00
6SN	Loadliner. Semi-rigid boot tray for protecting boot area	•	•	£51.06	£60.00
6SU	Loadliner with reversible load mat	•	•	£119.15	£140.00
3Y4	Manual blinds for rear side windows	•	•	£85.11	£100.00
3FU	Panoramic sunroof – glass roof covering both front and rear passengers with tilt-and-slide function. Includes retractable roller sun-blind	•	•	£936.17	£1,100.00
3CX	Net partition, removable net partition between rear seats and rear luggage compartment	•	•	£76.60	£90.00
3GN	Rail system with load-securing set. Load area rail system and fixing kit, includes load area rails, telescopic bar and securing belt for dividing the luggage compartment	•	•	£148.94	£175.00
6SJ	Reversible load mat with bumper cover. One side in rubber, the other in carpet	•	•	£68.09	£80.00
3X2	Ski/Snowboard bag with through-load facility. Practical transportation for up to four pairs of skis up to 200cm in length or two snowboards	•	•	£42.55	£50.00
5XH	Sun visor, retractable, extendable	•	•	£38.30	£45.00



Options are subject to availability and may extend delivery.
 – = Not available • = Available S = Standard

Exterior equipment

Order code		SE	S line	Basic RRP	Total RRP ^{inc. VAT}
8Q5	Adaptive lights. Swivelling headlights for improved illumination of winding roads	–	•	£276.59	£325.00
3S2	Black roof rails	•	•	No charge	No charge
2Z7	Deletion of engine capacity	•	•	No charge	No charge
2Z0	Deletion of engine capacity and model designation	•	•	No charge	No charge
6XE	Door mirrors, electrically adjustable, heated and folding	•	•	£157.45	£185.00
6XL	Door mirrors, electrically adjustable, heated, folding and auto-dimming, with memory function	•	•	£242.55	£285.00
4E9	Electrically operated tailgate	•	•	£319.15	£375.00
4KF	Privacy glass	•	•	£276.60	£325.00
1D4	Towbar, manually folding	•	•	£553.19	£650.00



Door mirrors, electrically adjustable, heated and folding



Deletion of engine capacity and model designation



Technical data

Audi Q5

Petrol

Engine	Cylinder	Displacement, cubic cm (valves per cylinder)	Max. power ¹ , PS at rpm	Max. torque, Nm at rpm	Transmission	CO ₂ emissions ² , g/km	0-62mph acceleration, seconds	Top speed, mph	ABI insurance group
2.0 TFSI	4-cylinder	1984 (4)	211/6000	350/1500-4200	7-speed S tronic	197	7.2	137	15E

Diesel

2.0 TDI*	4-cylinder	1968 (4)	170/4200	350/1750-2500	6-speed manual	175	9.5	126	14E
3.0 TDI*	6-cylinder	2967 (4)	240/4400	500/1500-3000	7-speed S tronic	199	6.5	139	17E



*With Diesel Particulate Filter

¹The given value was obtained in accordance with the specified measurement procedure (the respective current version of the Directive 80/1269/EEC).

²The given values were calculated in accordance with the specified measurement procedure (the respective current version of Directive 80/1268/EEC). This information does not relate to a single vehicle and does not comprise part of the offer but is merely intended for the purpose of comparison between the different vehicle types.

Weights, kg			Max. trailer load ⁴ , kg			Volumes		Fuel consumption, mpg (l/100km)			
Unladen weight ³	Gross weight limit	Roof load limit/nose weight	unbraked	with 12% gradient	with 8% gradient	Luggage compartment capacity, litres		Fuel tank capacity approx, litres	Urban	Extra Urban	Combined
						rear seats upright	rear seats folded				
1740	2320	100/80	750	2000	2400	540	1560	75	27.1 (10.4)	38.6 (7.3)	33.2 (8.5)
1730	2310	100/80	750	2000	2400	540	1560	75	34.4 (8.2)	48.7 (5.8)	42.1 (6.7)
1865	2445	100/80	750	2000	2400	540	1560	75	30.7 (9.2)	42.8 (6.6)	37.6 (7.5)



³Vehicle's unladen weight without driver (calculated in accordance with the current version of Directive 80/1268/EEC). The fitting of additional equipment may increase the vehicle's unladen weight and drag coefficient, whereupon the potential carrying capacity and top speed will be correspondingly reduced.

⁴The engine's power output always goes down with increasing altitude. At 1000m above sea level, and for every additional 1000m, deduct 10% from the weight of the outfit (trailer load limit + gross weight of the towing vehicle).

Dimensions

Audi Q5

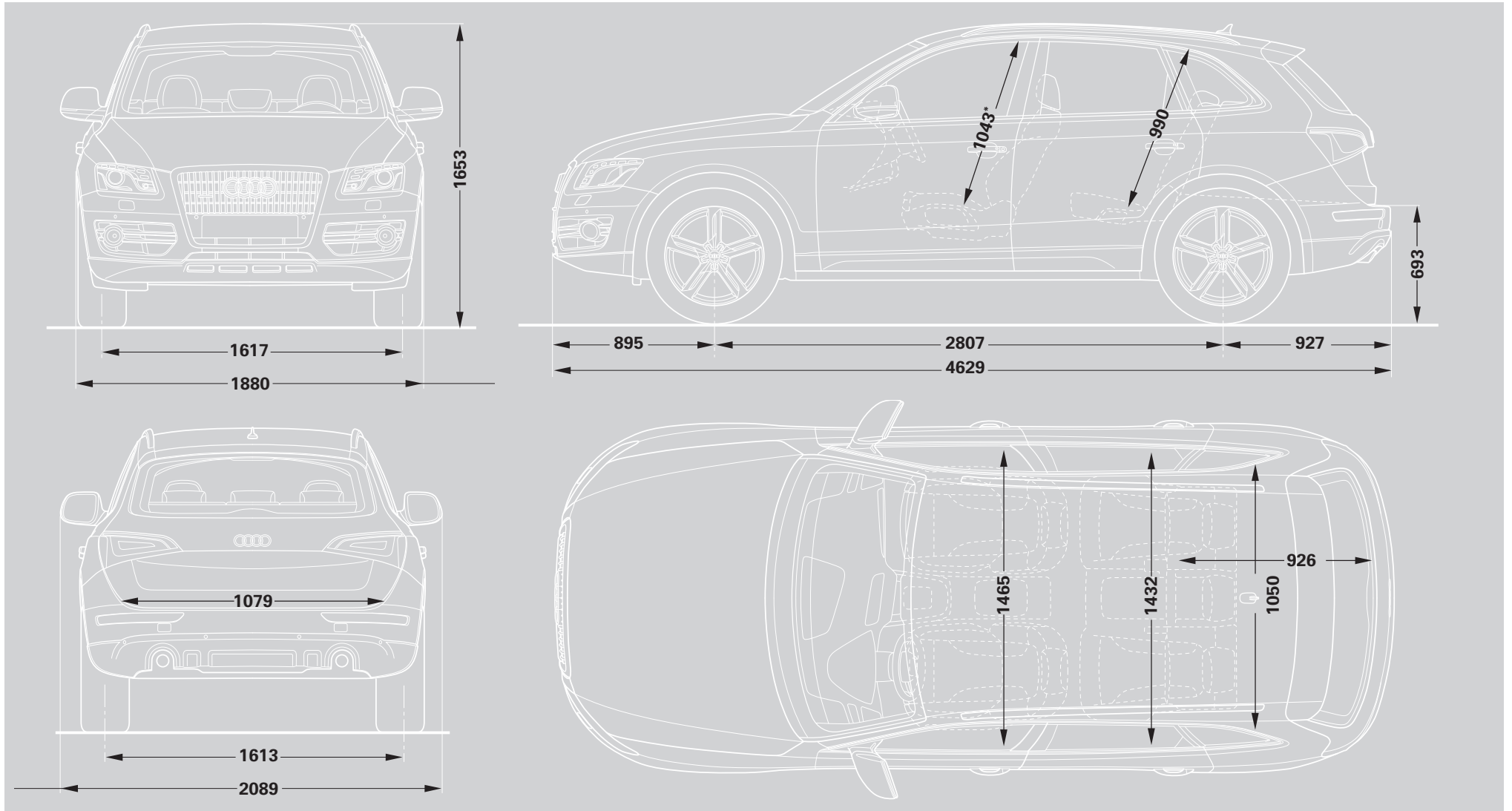

Dimensions were measured with vehicle at unladen weight. Turning circle approx 11.7m.
*Maximum head room.

Dimensions in millimetres.



Additional information

CO2 data and information

CO2 emissions-based Vehicle Excise Duty

Vehicle Excise Duty (Road Fund Licence) is based upon the amount of Carbon Dioxide (CO2) a vehicle emits, measured in grams per kilometre (g/km). The DVLA has created seven categories:

Petrol and Diesel engines	
A – up to 100g/km	£0.00
B – 101 to 120g/km	£35.00
C – 121 to 150g/km	£120.00
D – 151 to 165g/km	£145.00
E – 166 to 185g/km	£170.00
F – 186 to 225g/km	£210.00
G – over 225g/km	£400.00

CO2 emissions-based Vehicle Excise Duty

The CO2 emission figures quoted in the technical data section on pages 40-41 are based on a fully-laden vehicle, including the driver, and the heaviest possible options configuration. Actual CO2 emissions may be lower depending on options selected.

Audi Servicing

Servicing tailored to your needs

Regular servicing is key to safeguarding your Audi's performance and a full Audi service history could help you preserve the future re-sale value. To make servicing easy, the Audi Service Schedules have been designed to work with your individual driving style and vehicle.

There are two schedules available and your Audi Centre will advise which schedule is most suited to your needs. The conventional fixed Audi Inspection Service schedule

Inspection Service Regime

	Vehicle usage:
Mileage	Less than 10,000* miles per annum
Type of journey	Mainly city/town centre driving. Short journeys
Conditions	Frequent cold starts. High engine loading – e.g. frequent hill climbs, vehicle fully loaded, towing
Driving style	Uneconomical – e.g. heavy acceleration, heavy braking, constant changes in speed, constant use of high revs, 'sporty' driving

Enhanced LongLife servicing

	Fixed Audi Inspection Service Intervals:
Oil-change Service	Fixed to approximately every 10,000* miles/1 year
Inspection Service	Fixed to approximately every 20,000* miles/3 years, then approximately every 20,000* miles/2 years thereafter

has fixed intervals for the Oil Change and Inspection Service that are based on time and distance, whichever comes first. With the Audi LongLife Service schedule, sensors take account of driving style and conditions in which the vehicle is used to indicate when the Oil Change Service is required. Oil Change Service intervals are therefore variable and are conveniently indicated via the on-board service interval display.

LongLife Service Regime

	Vehicle usage:
Mileage	More than 30 miles per day
Type of journey	Motorway and main road driving. Mainly longer distance journeys. Constant speeds
Conditions	Normal engine loading – e.g. with little or no towing, with little or no hill climbs. Normal vehicle loading
Driving style	Moderate acceleration, moderate braking, engine revs mainly below 3,000

	Audi LongLife Service Intervals:
Oil-change Service	Variable to a maximum of approximately every 20,000* miles/2 years
Inspection Service	Fixed to approximately every 20,000* miles/3 years, then approximately every 20,000* miles/2 years thereafter

*As indicated by the service interval display. Mileages are approximate as the Service Indicator system uses kilometres as its distance measurement.

Service by Design

At Audi, we believe our customers have the right to expect excellent service each and every time they make contact with us. To ensure that this happens, we have agreed a set of service standards with our Audi Centre network that governs the way they do business with you. These standards apply to both Sales and Aftersales, and we actively monitor our Centres to ensure that you receive the highest level of customer service. These service standards will ensure a consistent, stress-free experience whenever you are in contact with anyone representing the Audi brand.

Every Audi Centre will be open during the following hours:

Sales: 9am–6pm Monday to Friday
9am–5pm Saturday

Service: 8am–6pm Monday to Friday
8.30am–1pm Saturday

Sunday opening at local discretion.

Test drives

Whilst we cannot always have the desired demonstrator car ready immediately, we will confirm arrangements for a test drive within two working days (subject to status).

New Car delivery

Once we have confirmed a delivery date with you, we will keep you informed of progress. In the unlikely event of a delay, we will provide you with a courtesy car to minimise inconvenience and keep you mobile.

Delivery to any location within the UK

To maximise your Audi experience right from the first day of ownership, we will deliver your car to your preferred location – whether that's home or your place of work (subject to reasonable notice).

Every attention to detail

Your ownership experience starts with half a tank of fuel.

Quotation response

We are committed to answering any quotation request within 1 working day.

Training

We run a continuous training development programme for all our staff so that we consistently deliver a high-quality, professional service.

Formal complaints procedure

We have a complaints procedure designed to ensure any negative issue you raise with us is dealt with properly.

Courtesy cars

When your car is off the road, perhaps due to a scheduled service or MOT, we will offer you an Audi Courtesy Vehicle until yours is ready. We'll even collect from and deliver to your chosen location, keeping hassle to an absolute minimum.

Service bookings

If you do not require a courtesy car, we will service your Audi within a maximum of 5 working days. If you do choose to take a courtesy car, we will promise to service your vehicle within a maximum of 10 working days.

Cleaning

When your car comes to our workshop, we will wash and vacuum it at no extra cost.

No hidden charges

You will be consulted before we carry out any necessary work on your vehicle, and anything charged for will be itemised on your bill. No extra work will be undertaken without your permission.

A personal service

All work will be done by a named Audi technician, to whom you can personally direct questions or requests should you need to.

Environmental commitment

We promise to dispose of all non-biodegradable materials from your vehicle in a responsible manner.



Pricing information

Pricing

Prices and specifications given are correct at the time of printing. Always check details with your Audi Centre, as Audi policies are continually developing. We reserve the right to change prices or specifications at any time.

All prices are subject to VAT, currently charged at 17.5%.

Delivery charges and number plates are not included in the vehicle price.

Delivery charge	£469.36
Number plates	£20.00
VAT	£85.64
Total	£575.00

Audi Roadside Assistance

Your new car comes complete with complimentary roadside assistance and recovery across the UK provided by RAC Motoring Services. Also included is roadside assistance throughout Europe, managed by RAC Motoring Services.

Audi Customer Care

Every new Audi benefits from the comprehensive Audi Customer Care Package, which comprises:

- ▶ A 3-year Audi warranty, which covers you for unlimited mileage in the first 2 years of ownership, with a full mechanical and electrical warranty which covers you for up to 60,000 miles in the 3rd year
- ▶ A 3-year paint warranty
- ▶ A 12-year anti-corrosion warranty
- ▶ Up to 3 years' UK roadside assistance and recovery.

This package, together with Audi variable Service intervals, offers a combination unmatched by any other major manufacturer. Contact your Audi Centre for full details.

Audi Tax-Free Sales

If you are entitled to purchase a vehicle free of VAT, normally through Military or Diplomatic privilege, please contact your local Audi Centre for full details.

Should you have any difficulty obtaining the information you require, please call Freephone 0800 585878.

Audi Finance

Audi Finance specialise in providing funding solutions for Audi drivers. Whether your Audi is for private or business use, there are a range of funding options to choose from.

Below is our full range of finance products.

- ▶ Solutions – a Personal Contract Plan
- ▶ Hire Purchase
- ▶ Lease Purchase
- ▶ Finance Lease
- ▶ Contract Hire

With all our finance products, you can choose one of our fixed-cost maintenance plans, which are designed to help you budget accurately.

No matter what Audi model you choose, your local Audi Centre can provide you with a personalised quote which could fit your budget and motoring needs.

Audi Finance is a trading name of Volkswagen Financial Services (UK) Limited. An offer of finance depends on certain conditions. Available to people over 18 in the UK only.

Audi Insurance

Competitive comprehensive motor insurance designed specially for Audi drivers. All new Audi models come with complimentary seven-day cover upon request – we'll email a cover note directly to your Audi Centre, enabling them to tax your car easily. This way, you can drive straight out of the showroom. Taking out an annual policy is easy and can begin as soon as your free seven-day cover expires.

For more information, contact your local Audi Centre. Alternatively, call 0800 051 3146 for a quote and to receive 7 days' complimentary cover for your new Audi.

Audi Insurance is underwritten and administered by Zurich Insurance Company.

Notes

Notes