



The A4 and S4 Cabriolet
Pricing and Specification Guide
Valid from December 2008



A User's Guide

This guide has been designed to help you tailor and price your A4 Cabriolet model quickly and logically. At the back of this guide, you will also find information on CO2 emissions-based vehicle excise duty and the other services offered by Audi, including Finance and Insurance. If you wish, you can also go to audi.co.uk and configure your A4 Cabriolet online.

Tune into the Audi Channel at any time on Sky Guide No. 884 to see a whole range of programmes about the Audi range and our motorsport achievements.



Table of content

Page Number

Introduction	
The A4 and S4 Cabriolet	
Engines and quattro®	6
Model details and prices	
Standard models	8
Sport models	10
S line models	12
S line Special Edition model	14
S4 models	16
Transmission	18
Colour and upholstery	
Paint finishes	20
Hood colours	22
Upholstery options	24
Colour and trim guide	28
Inlays	30
Options	
Wheels, tyres and suspension	32
Audio and communication	34
Safety and security	36
Interior equipment	38
Seats	38
Exterior equipment	40
Audi Centre-fitted Accessories	42
Audi exclusive	
Audi exclusive options	44
Audi exclusive line	50
Technical details	
Technical data	52
Dimensions	54
Additional information	56

The A4 Cabriolet

The A4 Cabriolet has an elegance and sophistication rarely found in a car this powerful. The 233PS 3.0 TDI® quattro®, for example, is capable of reaching 62mph in just 7.3 seconds – acceleration credentials guaranteed to blow away the cobwebs, even with the roof up. And with five other potent engines available – both petrol and TDI® – as well as quattro® permanent all-wheel-drive and the Audi dynamic chassis, the A4 Cabriolet's performance capabilities more than live up to its powerful looks.

Luxury also comes as standard on the Audi A4 Cabriolet. A fully automatic electric soft-top lets you transform your driving environment within seconds; and if conditions change, electronic climate control is also included as standard. Add to that the A4 Cabriolet's comfortable, well-appointed interior, featuring luxuries such as a leather multi-function steering wheel, and you'll be driving one of the most desirable 4-seater convertibles available.





Petrol

There are two kinds of engine available on the A4 Cabriolet – the traditional fuel-injection engine and the FSI® direct-injection engine. FSI® is a unique Audi technology originally developed for the Le Mans 24-hour endurance race to deliver increased power and torque as well as enhanced fuel efficiency. The way it does this is, in theory, very simple. Precisely the right amount of fuel and air are injected directly into the combustion chambers, enabling the engine to 'breathe' more easily. At the same time, electronics monitor the engine load and adjust the injection process. The result – reduced heat-loss and increased output, with around a 15% reduction in fuel consumption and significantly lower exhaust emissions. Ideal for the buyer who wants a dynamic, exhilarating drive without the drawbacks of excessive fuel costs or high emissions.

Diesel

All diesel engines from Audi are known as TDI®. This impressive technology was originally pioneered by Audi in 1989, marking a departure from the noisy, fuel-thirsty diesel engines of the past. Like its FSI® petrol counterpart, the TDI® diesel engine is designed for power, performance, low fuel consumption and reduced emissions. The 2.0 TDI 4-cylinder engine is based on the proven pompe-duse technology – a system which combines both the pump and injector in one compact, lightweight unit.

The 3.0 TDI V6 engine is based on the common rail system. Here, fuel is stored and kept at constant pressures of up to 1,600 bar, ready to feed a series of highly accurate piezo injectors, which control the rate and point of injection.



quattro®

Permanent all-wheel-drive

It's the technology that has given Audi the edge on the racetrack ever since it was first introduced over 25 years ago – a technology that delivers ultimate control whilst enhancing the sporty characteristics which make the A4 Cabriolet so thrilling to drive. It's called quattro® permanent all-wheel-drive. The principle is simple: in the same way that four brakes ensure better deceleration, four permanently-driven wheels deliver better acceleration and road-holding, pushing or pulling the car in the right way as needed, for a driving experience that's both dynamic and safe. In the A4 Cabriolet, drive power is continuously distributed between the front and rear axles depending on weather conditions, road surface and gradient. On S4 and RS 4 Cabriolet models, quattro® is taken one step further with asymmetric-dynamic torque distribution, which increases flexibility for an enhanced, sportier drive.



Standard model equipment

All A4 Cabriolet models have the following items of standard equipment:

Wheels, tyres and suspension

16 x 7J '7-arm' design alloy wheels fitted with 215/55 R16 Y tyres

Full-size spare wheel

Audio and communication

Concert radio with single front-loading CD

Digital clock with date

Diversity radio aerial integrated into the boot lid

Nine loudspeakers (180 Watt total output)

Safety and security

Anti-lock Braking System (ABS)

Anti-theft alarm with interior microwave protection (Thatcham Category 1 approved)

Anti-theft wheel bolts

Automatic roll-over protection system

Automatically-triggered protective system behind the rear headrests

Driver and front passenger airbags

Electronic Brake-force Distribution (EBD) with 'Brake Assist'

Electronic Stability Programme (ESP)

Seat belt reminder with visual and acoustic warning

Side airbags for front seats

Side-impact protection

Visible Vehicle Identification Number (VIN)

Warning triangle

Interior equipment

12V power socket in the boot

Adjustable steering column (height and reach)

Brushed grey Aluminium dashboard and door-capping inlays

Can holder in centre console

Driver and passenger vanity mirrors

Driver's Information System (DIS)

Dust and pollen filter

Electronic climate control, independently adjustable for passenger and driver

Front centre armrest with hinged storage compartment

Front underseat storage trays and seat-back nets

Leather 4-spoke multi-function steering wheel (with gear-change paddles on multitronic® and tiptronic® models)

Outside-temperature gauge

Remote-controlled central locking (including the glove box) servotronic speed-related power steering (not on 1.8T or 2.0 TDI models)

Tailored front and rear carpet mats

Seats

Front seat belt pre-tensioners

Height-adjustable front seats

ISOFIX front passenger and rear seat preparation

Olympic cloth upholstery

Through-load facility (ski bag)

Exterior equipment

Colour-keyed door handles and mirrors

Electric front and rear windows

Electric headlight adjustment

Electrically-adjustable door mirrors

Halogen headlights

Front and rear foglights

Fully automatic electrically-operated soft-top

Galvanised body

Heat-insulating green-tinted glass

Soft-top box – variable to increase boot space as required

'Soft-touch' boot release

Additional equipment on 3.2 FSI and 3.0 TDI models over and above standard models:

6-CD autochanger (or iPod connection as no-cost option in lieu of 6-CD autochanger)

CD Satellite Navigation system

Colour Driver's Information System (DIS)



16 x 7J '7-arm' design alloy wheels

Standard model prices

Petrol

Engines	Power	Transmission	Basic RRP	Total RRP ^{inc. VAT}	Recommended OTR
1.8T	163PS	5-speed manual	£21,878.26	£25,160.00	£25,990.00
2.0 TFSI	200PS	6-speed manual	£23,004.35	£26,455.00	£27,285.00
3.2 FSI	256PS	7-speed multitronic®	£27,300.00	£31,395.00	£32,415.00
3.2 FSI quattro®	256PS	6-speed manual	£27,256.52	£31,345.00	£32,365.00

Diesel

Engines	Power	Transmission	Basic RRP	Total RRP ^{inc. VAT}	Recommended OTR
2.0 TDI	140PS	6-speed manual	£22,600.00	£25,990.00	£26,780.00
3.0 TDI quattro®	233PS	6-speed manual	£27,834.78	£32,010.00	£32,840.00



Concert radio



Through-load facility (ski bag)



Driver's Information System (DIS)

Please note: The maximum power output figures are quoted in PS (or Pferdestärke, which is the metric equivalent of brake horsepower). To convert to horsepower, divide the PS figure by 1.0139.
Recommended On-The-Road (OTR) retail prices include: delivery charge, half a tank of fuel, number plates at £565.00 (inc. VAT) and Road Fund Licence (which may vary depending on model/transmission. See page 56 for details) and first registration fee at £55.00.

RRP – Recommended Retail Price.

Sport model equipment

In addition to Standard model equipment:

Basic RRP	Total RRP <small>inc. VAT</small>
£639.13	£735.00

Wheels, tyres and suspension

17 x 7.5J '5-parallel twin-spoke' design alloy wheels with 235/45 R17 Y tyres



17 x 7.5J '5-parallel twin-spoke' design alloy wheels

Seats

Sports seats with electric lumbar support



3-spoke Sports multi-function leather steering wheel

Interior equipment

3-spoke Sports multi-function leather steering wheel (with gear-change paddles on automatic models)
Leather gear knob and gaiter



Sports seats with electric lumbar support

Sport model prices

Petrol

Engines	Power	Transmission	Basic RRP	Total RRP ^{inc. VAT}	Recommended OTR
1.8T	163PS	5-speed manual	£22,517.39	£25,895.00	£26,725.00
2.0 TFSI	200PS	6-speed manual	£23,643.48	£27,190.00	£28,020.00
3.2 FSI	256PS	7-speed multitronic®	£27,939.13	£32,130.00	£33,150.00
3.2 FSI quattro®	256PS	6-speed manual	£27,895.65	£32,080.00	£33,100.00

Diesel

Engines	Power	Transmission	Basic RRP	Total RRP ^{inc. VAT}	Recommended OTR
2.0 TDI	140PS	6-speed manual	£23,239.13	£26,725.00	£27,515.00
3.0 TDI quattro®	233PS	6-speed manual	£28,473.91	£32,745.00	£33,575.00



Please note: The maximum power output figures are quoted in PS (or Pferdestärke, which is the metric equivalent of brake horsepower). To convert to horsepower, divide the PS figure by 1.0139.
Recommended On-The-Road (OTR) retail prices include: delivery charge, half a tank of fuel, number plates at £565.00 (inc. VAT) and Road Fund Licence (which may vary depending on model/transmission. See page 56 for details) and first registration fee at £55.00.

RRP – Recommended Retail Price.

S line model equipment

In addition to Standard model equipment:

Basic RRP	Total RRP <small>inc. VAT</small>
£2,043.48	£2,350.00

Wheels, tyres and suspension

18 x 8J '5-arm' design alloy wheels fitted with 235/40 R18 Y tyres

S line Sports suspension (with 10mm reduction in ride height)

Seats

Sports seats with electric lumbar adjustment
Black Pearl Nappa leather upholstery

Interior equipment

Matt-brushed aluminium finish inlays

Exterior equipment

S line exterior badging
Clear indicator lenses

For all S line vehicles registered by 30 June 2008

S line exterior package for free, including the following items:

- ▶ S line restyled front bumper
- ▶ S line rear diffuser
- ▶ S line side skirt extensions



3-spoke 'S line' part-perforated multi-function leather steering wheel



18 x 8J '5-arm' design alloy wheels



Manual transmission in brushed matt aluminium finish

S line model prices

Petrol

Engines	Power	Transmission	Basic RRP	Total RRP ^{inc. VAT}	Recommended OTR
1.8T	163PS	5-speed manual	£23,921.74	£27,510.00	£28,340.00
2.0 TFSI	200PS	6-speed manual	£25,047.83	£28,805.00	£29,635.00
3.2 FSI	256PS	7-speed multitronic®	£29,343.48	£33,745.00	£34,765.00
3.2 FSI quattro®	256PS	6-speed manual	£29,300.00	£33,695.00	£34,715.00

Diesel

Engines	Power	Transmission	Basic RRP	Total RRP ^{inc. VAT}	Recommended OTR
2.0 TDI	140PS	6-speed manual	£24,643.48	£28,340.00	£29,130.00
3.0 TDI quattro®	233PS	6-speed manual	£29,878.26	£34,360.00	£35,190.00



Please note: The maximum power output figures are quoted in PS (or Pferdestärke, which is the metric equivalent of brake horsepower). To convert to horsepower, divide the PS figure by 1.0139.
Recommended On-The-Road (OTR) retail prices include: delivery charge, half a tank of fuel, number plates at £565.00 (inc. VAT) and Road Fund Licence (which may vary depending on model/transmission. See page 56 for details) and first registration fee at £55.00.

RRP – Recommended Retail Price.
Please note: image shows A4 Cabriolet with 18 x 8J '9-spoke' design alloy wheels and S line exterior styling pack.

S line Special Edition model equipment

In addition to S line model equipment:

Wheels, tyres and suspension

18 x 8J '5-arm' design alloy wheels fitted with 235/40 R18 Y tyres

S line Sports suspension (with 10mm reduction in ride height)

Seats

Sport seats with electric lumbar adjustment

Black Pearl Nappa leather upholstery

Interior equipment

Matt-brushed aluminium finish inlays

Exterior equipment

S line exterior badging

Clear indicator lenses

S line exterior package including the following items:

- ▶ S line restyled front bumper
- ▶ S line rear diffuser
- ▶ S line side skirt extensions

Petrol

Engines	Power	Transmission	Basic RRP	Total RRP ^{inc. VAT}	Recommended OTR
2.0 TFSI	200PS	6-speed manual	£24,808.70	£28,530.00	£29,360.00



Please note: The maximum power output figures are quoted in PS (or Pferdestärke, which is the metric equivalent of brake horsepower). To convert to horsepower, divide the PS figure by 1.0139.
Recommended On-The-Road (OTR) retail prices include: delivery charge, half a tank of fuel, number plates at £565.00 (inc. VAT) and Road Fund Licence (which may vary depending on model/transmission. See page 56 for details) and first registration fee at £55.00.

RRP – Recommended Retail Price.
Please note: image shows A4 Cabriolet with 18 x 8J '9-spoke' design alloy wheels and S line exterior styling pack.

S line Final Edition model equipment

In addition to S line model equipment:

Wheels, tyres and suspension

18" '7-arm double-spoke' RS 4 style alloy wheels in Titanium finish

Seats

Black Pearl Nappa seats

Audio and Communication

6 CD changer or iPod connection in glove box

BOSE® speaker system

DVD Satellite Navigation

Safety and Security

Rear acoustic parking system

Xenon headlights

Petrol

Engines	Power	Transmission	Basic RRP	Total RRP ^{inc. VAT}	Recommended OTR
2.0 TFSI	200PS	manual	£24,808.70	£28,530.00	£29,360.00

Diesel

Engines	Power	Transmission	Basic RRP	Total RRP ^{inc. VAT}	Recommended OTR
2.0 TDI	140PS	manual	£24,726.09	£28,435.00	£29,225.00
3.0 TDI	233PS	manual	£29,875.26	£34,360.00	£35,190.00

Please note: The maximum power output figures are quoted in PS (or Pferdestärke, which is the metric equivalent of brake horsepower). To convert to horsepower, divide the PS figure by 1.0139.
Recommended On-The-Road (OTR) retail prices include: delivery charge, half a tank of fuel, number plates at £565.00 (inc. VAT) and Road Fund Licence (which may vary depending on model/transmission. See page 56 for details) and first registration fee at £55.00.

RRP – Recommended Retail Price.



Transmissions

multitronic®

Translating a driver's preferences and intentions into road performance, the multitronic® automatic transmission system entertains no compromises – whether in terms of dynamism, convenience or economy. multitronic® is available on front-wheel-drive models. A continuously variable transmission, multitronic® operates in an exceptionally wide range of gear ratios thanks to its steel link-plate chain construction. The result is exceptional driving comfort, as well as smooth, powerful acceleration over the entire range of engine speeds. In addition, thanks to its lightweight design and the DRP Dynamic Regulating Programme which monitors gradient, road conditions and the way the driver is using the accelerator pedal, multitronic® also plays an instrumental role in reducing fuel consumption. And with seven simulated gear ratios available, you can enjoy all these benefits whilst adopting the sporty driving style of a manual.

tiptronic®

The 6-speed tiptronic® transmission system is a form of automatic transmission available on A4 Cabriolet models with quattro® permanent all-wheel-drive. The technology incorporates DSP – or the Dynamic Shift Programme which aligns and converts the engine's high power and torque into both smooth performance and operating convenience, with crisp, fast gear changes, reduced weight and optimised gearshifting. In the 'D' (Drive) and 'S' (Sport) programme, the advanced electronics used in tiptronic® respond efficiently to every driver input, helping to prevent unwanted gear-changes. The driver can override automatic mode by moving the gear lever into a tiptronic® shift-gate, enabling spontaneous gear-changing for a more dynamic driving style.



Transmissions

Transmission

	1.8T	2.0 TFSI	3.2 FSI	3.2 FSI quattro [®]	2.0 TDI	3.0 TDI quattro [®]	S4 quattro [®]	Basic RRP	Total RRP ^{inc. VAT}
Automatic multitronic [®] transmission	•	•	S	-	•	-	-	£1,234.78	£1,420.00
Automatic tiptronic [®] transmission	-	-	-	•	-	•	•	£1,191.30	£1,370.00

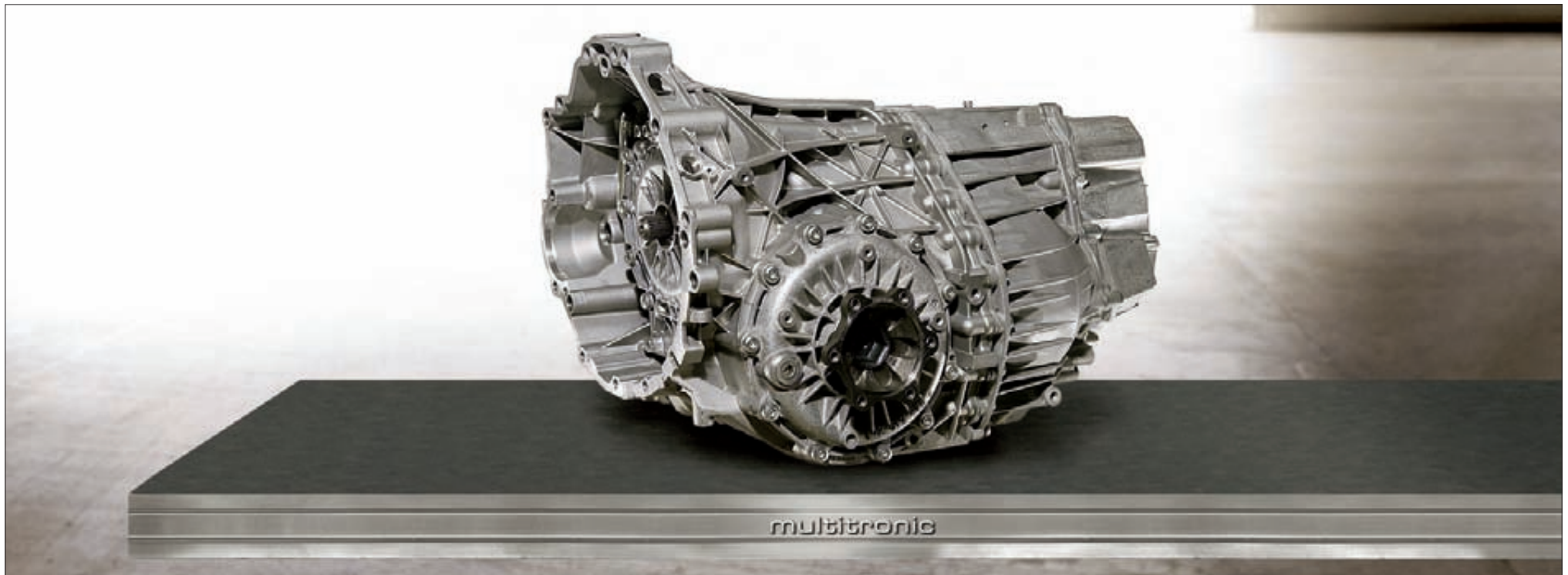

Options are subject to availability and may extend delivery.
 - = Not available • = Available S = Standard

RRP – Recommended Retail Price.

Paint finishes

Standard colours



Brilliant black

A2



Brilliant red – only available on S4 Cabriolet models

C8

Optional colours

Basic RRP	Total RRP <small>inc. VAT</small>
£426.09	£490.00



Silver, metallic

5B



Phantom black, pearl effect

L8



Akoya silver, metallic – not available on S4 Cabriolet models

2S

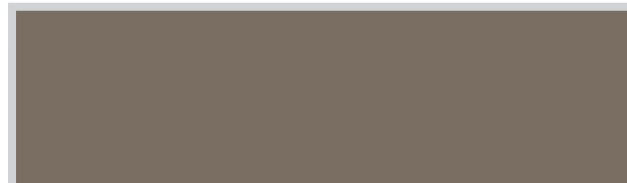

Alpaca beige, metallic – not available on S4 Cabriolet models

Y5

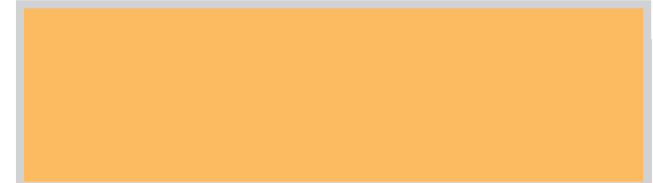

Cosmic yellow, metallic – not available on S4 Cabriolet models

5R



Garnet red, pearl effect – not available on S4 Cabriolet models

9C

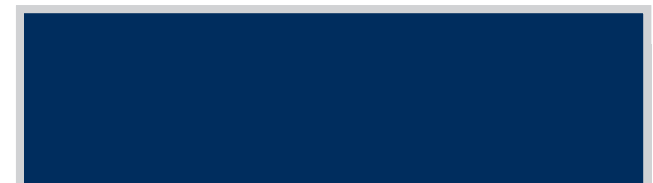

Mauritius blue, pearl effect – not available on S4 Cabriolet models

2Y



Quartz grey, metallic – not available on S4 Cabriolet models

Q4

S line additional colours



Dolphin grey, metallic – not available on S4 Cabriolet models

F5

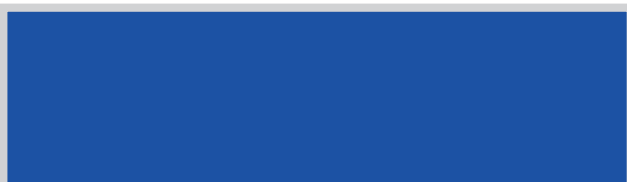

Moro blue, pearl effect – not available on S4 Cabriolet models

P7



Sprint blue, pearl effect – only available on S4 models

5N

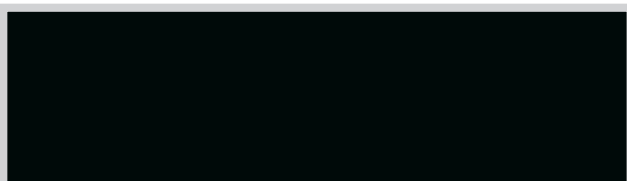

Deep green, pearl effect – only available on S4 models

3W



Avus silver, pearl effect – only available on S line models

C2



Misano red, pearl effect – only available on S line models

N9

Also available on non S line models at Audi exclusive paint price. Please refer to page 49 for details.

Hood colours

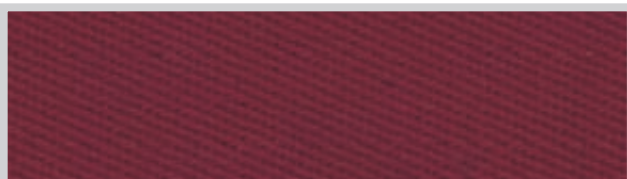

Red hood

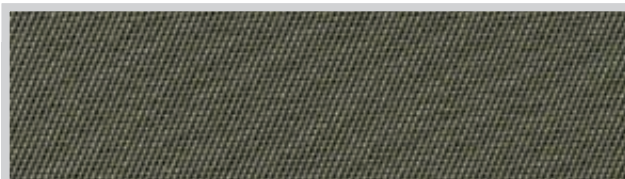

Beige hood – not available on S4 Cabriolet



Black hood



Blue hood





Upholstery

Standard seats



Olympic cloth, Black MG/NK

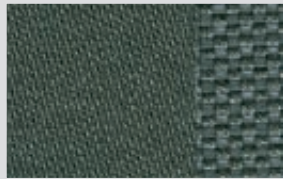

Olympic cloth, Light grey HD/NQ



Olympic cloth, Deep blue MJ/MF



Pearl Nappa leather, Black MG/NK



Pearl Nappa leather, Light grey HD/NQ



Pearl Nappa leather, Deep blue MJ/MF









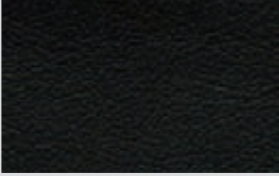
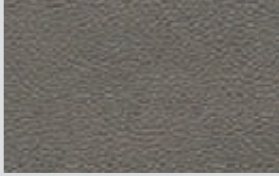

Pearl Nappa leather, Beige NR

	Standard	Sport	S line	S4	Basic RRP	Total RRP ^{inc. VAT}
	S	-	-	-	No charge	No charge
	•	-	-	-	£1,086.96	£1,250.00



Upholstery

Sports seats

		Standard	Sport	S line	S4	Basic RRP	Total RRP ^{inc. VAT}
	MG/NK	●	-	-	-	£1,486.96	£1,710.00
	HD/NQ	-	●	-	-	£1,086.96	£1,250.00
	MJ/MF	-	-	-	-		
	NR	-	-	-	-		
	HG/HF/HL/HK	-	-	-	-		
	MM/HE	-	-	-	-		
	HM/HN/HH/HJ	-	-	-	-		
	MB	●	-	-	-	£1,213.04	£1,395.00
	MD	-	●	-	S	£808.70	£930.00

S line and S line Special Edition Sports seats



	MG/NK	-	-	S	-	No charge	No charge
---	-------	---	---	---	---	-----------	-----------

All leather upholstery choices include seats, head restraints, door panels and front centre armrest in leather.
Alcantara/leather choices include head restraints, seat side bolsters and front centre armrest in leather with the seat centres and door panels in Alcantara.

RRP – Recommended Retail Price

Upholstery

S4 Cabriolet Sports seats

		S4	Basic RRP	Total RRP <small>inc. VAT</small>
 		S	No charge	No charge
<p>Alcantara/Pearl Nappa leather, Black ZM</p> <p>Alcantara/Pearl Nappa leather, Silver ZQ</p>				
 		•	£447.83	£515.00
<p>Silk Nappa leather, Black with silver piping ZM</p> <p>Silk Nappa leather, Silver with black piping ZQ</p>				
		•	£934.78	£1,075.00
<p>Silk Nappa leather, Carmine red with piping ZM</p>				



Colour and trim guide

To help you choose the right interior for your Audi A4 Cabriolet, please use the guide below which shows the carpet, dashboard and headlining colours that have been matched to your chosen upholstery.

Standard seats – Interior trim colours:

Order code	Upholstery	Carpet	Dashboard	Headlining	Olympic cloth	Pearl Nappa leather
MG	Black	Black	Black	Black	●	●
NK	Black	Black	Black	Silver	●	●
HD	Light grey	Light grey	Grey/Light grey	Black	●	●
NQ	Light grey	Light grey	Grey/Light grey	Silver	●	●
MJ	Deep blue	Deep blue	Deep blue	Black	●	●
MF	Deep blue	Deep blue	Deep blue	Silver	●	●
NR	Beige	Beige	Dark beige/Beige	Beige	–	●

S line and S line Special Edition – Interior trim colours :

Order code	Upholstery	Carpet	Dashboard	Headlining	Pearl Nappa leather*
QE	Black	Black	Black	Black	S

S4 – Interior trim colours :

Order code	Upholstery	Carpet	Dashboard	Headlining	Alcantara/Pearl Nappa leather	Silk Nappa leather*
ZM	Black/Black	Black	Black/Black	Black	●	–
ZQ	Silver/Silver	Black	Black/Black	Black	●	–
ZM	Black with silver piping	Black	Black/Black	Black	–	●
ZQ	Silver with black piping	Black	Black/Black	Black	–	●
ZU	Crimson red with black piping	Black	Black/Black	Black	–	●

Colour and trim guide

Sports seats – Interior trim colours:

Order code	Upholstery	Carpet	Dashboard	Headlining	Olympic Cloth	Pearl Nappa leather	Leather/Alcantara
MM	Wine red	Black	Black	Black	–	●	–
HE	Wine red	Black	Black	Silver	–	●	–
HG	Titanium grey	Black	Black	Black	–	●	–
HF	Titanium grey	Black	Black	Silver	–	●	–
HJ	Anis yellow	Black	Black	Black	–	●	–
HH	Anis yellow	Black	Black	Silver	–	●	–
HN	Anis yellow	Deep blue	Deep blue	Black	–	●	–
HM	Anis yellow	Deep blue	Deep blue	Silver	–	●	–
HL	Titanium grey	Deep blue	Deep blue	Black	–	●	–
HK	Titanium grey	Deep blue	Deep blue	Silver	–	●	–
NR	Beige	Beige	Deep beige/Beige	Beige	–	●	–
MG	Black	Black	Black	Black	●	●	●
NK	Black	Black	Black	Silver	●	●	●
HD	Light grey	Light grey	Grey/Light grey	Black	●	●	●
NQ	Light grey	Light grey	Grey/Light grey	Silver	●	●	●
MJ	Deep blue	Deep blue	Deep blue	Black	●	●	–
MF	Deep blue	Deep blue	Deep blue	Silver	●	●	–

Inlays

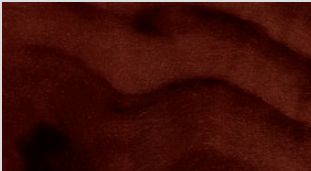
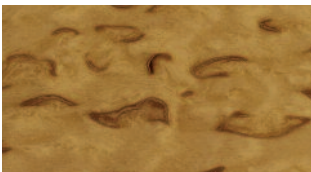
Order code			Standard	Sport	S line	S4	Basic RRP	Total RRP ^{inc. VAT}
5TG		Matt-brushed Aluminium, Silver	-	-	S	•	No charge	No charge
5TZ		Fine-grain Birch wood, Grey	• -	• -	- -	- •	£278.26 No charge	£320.00 No charge
5MG		Walnut brown	•	•	-	-	£278.26	£320.00
7TC		Fine-grain Birch wood, Beige	•	•	-	-	£278.26	£320.00
5TL		Piano finish, Black	-	-	•	•	No charge	No charge



Wheels, tyres and suspension

Order code		Standard	Sport	S line	S4	Basic RRP	Total RRP ^{inc. VAT}
PRH	17 x 7.5J '16-spoke' design alloy wheels with 235/55 R17 Y tyres including space-saver spare wheel	● -	- ●	- -	- -	£513.04 No charge	£590.00 No charge
PRV	17 x 7.5J '5-spoke Star' design alloy wheels with 235/45 R17 Y tyres including space-saver spare wheel	● -	- ●	- -	- -	£643.48 No charge	£740.00 No charge
PQT	17 x 7.5J '9-spoke' design alloy wheels with 235/45 R17 Y tyres including space-saver spare wheel	● -	- ●	- -	- -	£852.17 £256.52	£980.00 £295.00



17 x 7.5J '16-spoke' design alloy wheels



17 x 7.5J '5-spoke Star' design alloy wheels



17 x 7.5J '9-spoke' design alloy wheels

Wheels, tyres and suspension

Order code		Standard	Sport	S line	S4	Basic RRP	Total RRP ^{inc. VAT}
PQH	18 x 8J '15-spoke' design alloy wheels with 235/40 R18 Y tyres including space-saver spare wheel	●	-	-	-	£1,200.00	£1,380.00
		-	●	-	-	£600.00	£690.00
		-	-	●	●	£295.65	£340.00
PQW	18 x 8J '9-spoke' design alloy wheels with 235/40 R18 Y tyres including space-saver spare wheel	●	-	-	-	£1,200.00	£1,380.00
		-	●	-	-	£600.00	£690.00
		-	-	●	●	£295.65	£340.00
PQG	18 x 8J '5-arm' design alloy wheels with 235/40 R18 Y tyres including space-saver spare wheel	-	-	S	●	£295.65	£340.00
1G3	Full-size spare wheel for all optional 17" and 18" wheels	●	●	●	●	£126.09	£145.00



18 x 8J '15-spoke' design alloy wheels



18 x 8J '9-spoke' design alloy wheels



18 x 8J '5-arm' design alloy wheels

Audio and communication

Order code		Standard	Sport	S line	S4	Basic RRP	Total RRP ^{inc. VAT}
RSY	Audi Symphony radio with front-loading 6-CD autochanger and MP3 file compatibility	•	•	•	•	£226.09	£260.00
8RY	BOSE® sound system with 10 high-performance speakers and specially-tuned acoustics, total output 190 Watts	•	•	•	•	£382.61	£440.00
7A2	6-CD autochanger , mounted in glove box (standard on 6-cylinder models). Cannot be combined with iPod connection. (Only available in combination with CD-ROM-based Satellite Navigation system and DVD-based Satellite Navigation system Plus)	•	•	•	S	£273.91	£315.00
9ZF	Mobile phone preparation in dashboard with hands-free function, Bluetooth interface, roof aerial for optimal reception and charger. Can be operated via multi-function steering wheel if ordered. See your Audi Centre for phone compatibility and full details. A phone adapter is required at extra cost	•	•	•	•	£339.13	£390.00
PT5	Mobile telephone preparation in front centre arm rest with hands-free function, Bluetooth interface, roof aerial for optimal reception and charger. See your Audi Centre for phone compatibility and full details. A phone adapter is required at extra cost	•	•	•	•	£339.13	£390.00
PNY 7RF 9Q4	CD-ROM-based Satellite Navigation system , route planning and guidance using voice and pictogram instructions. Includes Driver's Information System (DIS) in colour, RDS radio, CD player, MMI operating logic, and UK CD-ROM disc. Located in dashboard in lieu of Concert radio. (6-CD autochanger is recommended with this option.) Standard on 6-cylinder and S4 models	•	•	•	S	£852.17	£980.00



BOSE® sound system



Audi Symphony radio



Mobile phone preparation in dashboard

Options are subject to availability and may extend delivery.
 – = Not available • = Available S = Standard

Audio and communication

Order code		Standard	Sport	S line	S4	Basic RRP	Total RRP ^{inc. VAT}
-	GSM mobile telephone cradles (applicable for factory-fitted GSM mobile-telephone preparation only)	•	•	•	•	£85.11	£100.00
PNU	DVD-based Satellite Navigation system Plus , DVD-based route planning with 6.5-inch colour monitor, RDS radio, MMC/SD card slot for MP3, Driver's Information System (DIS) in colour and European coverage DVD disc (where digitised). 6-CD autochanger or iPod connection is recommended with this option	4-cylinder models	•	•	-	£1,513.04	£1,740.00
		6-cylinder models	•	•	-	£660.87	£760.00
		S4 model	-	-	-	£660.87	£760.00
QV1	TV function , must be combined with DVD-based Satellite Navigation system Plus (price quoted does not include this item)	•	•	•	•	£600.00	£690.00
UF2	USB connection , for playing music from your USB stick in your A4 Cabriolet, located in glovebox and controlled via radio or multi-function steering wheel (if fitted). Cannot be combined with CD changer or iPod connection	•	•	•	•	£126.09	£145.00
UF1	iPod connection , for playing/charging your iPod in your A4 Cabriolet located in glove box and controllable with radio or multi-function steering wheel (cannot be combined with CD changer or CD-ROM-based Satellite Navigation system). It is not possible to display titles or artists on radio/navigation display or DIS (only on 4-cylinder models)	•	•	•	•	£147.83	£170.00
UF1	iPod connection , as above. Optional standard equipment in lieu of 6-CD autochanger (only on 6-cylinder, S4 and RS 4 models)	•	•	•	•	No charge	No charge

Centre-fitted integrated phone kits and supporting cradles are also available. Please consult your Audi Centre for cradle range and availability for both factory-fitted phone preparation and Centre-fitted options.



DVD-based Satellite Navigation system Plus



6-CD autochanger



iPod connection

Safety and security

Order code		Standard	Sport	S line	S4	Basic RRP	
7X2	Acoustic parking system (front and rear)	•	•	•	•	£434.78	£500.00
7X1	Acoustic parking system (rear only)	•	•	•	•	£278.26	£320.00
PU7	Automatically-dimming rear view mirror , with automatic low-beam headlights (includes rain and light sensors)	•	•	•	•	£134.78	£155.00
1T3	First-aid kit	•	•	•	•	£21.74	£25.00
VC1	Garage door opener (HomeLink®)* adaptive radio remote-control integrated into sun visor	•	•	•	•	£165.22	£190.00
8X1	Headlight-cleaning system (standard with Xenon Plus headlights)	•	•	•	•	£182.61	£210.00
6XD	Heated door mirrors and heated windscreen washers (standard with Xenon Plus headlights)	•	•	•	•	£95.65	£110.00
6XE	Heated, electrically-folding door mirrors	•	•	•	•	£204.35	£235.00
6XK	Heated, automatically-dimming, folding door mirrors. Must be combined with automatically-dimming rear view mirror (price quoted does not include this item)	•	•	•	•	£304.35	£350.00
7K7	Tyre-pressure monitoring system	•	•	•	•	£213.04	£245.00

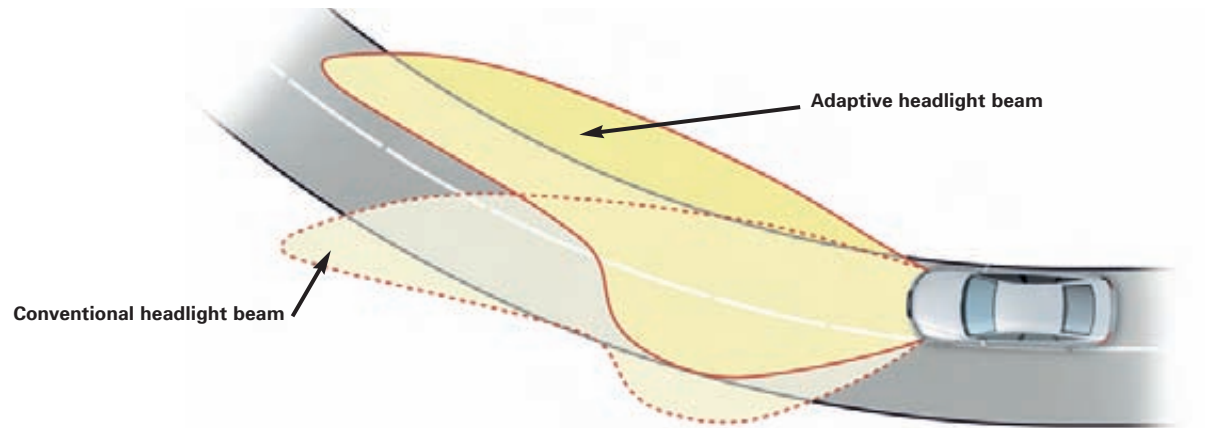



Interior equipment

Order code		Standard	Sport	S line	S4	Basic RRP	Total RRP ^{inc. VAT}
2V5	Automatic air-recirculation with air-quality sensor	•	•	•	•	£104.35	£120.00
1W1	Cool box in glove compartment	•	•	•	•	£52.17	£60.00
8T1	Cruise control for holding any speed above 25mph	•	•	•	•	£204.35	£235.00
9Q4	Colour Driver's Information System (DIS), with high resolution display (standard on 6-cylinder models and S4 Cabriolet)	•	•	•	S	£86.96	£100.00
QQ1	Interior light pack comprising entry/exit door lights, make-up mirrors and background lighting for centre console	•	•	•	S	£121.74	£140.00
6Q3	Gear Knob – Wood, matching inlay. Only in combination with wooden inlay (not Birch wood, Beige)	•	•	•	-	£78.26	£90.00



Cool box



Colour Driver's Information System (DIS)

Seats

Order code		Standard	Sport	S line	S4	Basic RRP	Total RRP ^{inc. VAT}
PV1	Electric front seats , with adjustment for height, forwards and backwards position, backrest angle and lumbar support for driver and front-passenger seats	●	-	-	-	£617.39	£710.00
		-	●	●	-	£452.17	£520.00
		-	-	-	S	No charge	No charge
PU7	Comfort pack , comprising electric front seats with memory function on driver's side, door mirrors – electrically folding and auto-dimming with memory function, auto-dimming rear view mirror and light and rain sensors which control the automatic headlights, the coming home/leaving home function and the automatic windscreen wipers	●	-	-	-	£1,226.09	£1,410.00
3L4		-	●	●	-	£1,052.17	£1,210.00
9T1		-	-	-	●	£547.83	£630.00
6XL 7P1							
PSV	Heated front seats	●	●	●	●	£213.04	£245.00
PSH	Heated front and outer rear seats	●	●	●	●	£408.70	£470.00



Sport seats

Exterior equipment

Order code		Standard	Sport	S line	S4	Basic RRP	Total RRP ^{inc. VAT}
3FT	Acoustic hood , sound-insulated for reduced road-noise	•	•	•	S	£204.35	£235.00
8Q5	Adaptive lights . Swivelling headlights for improved illumination of a winding road. Includes Xenon headlights and headlight-cleaning system	•	•	•	-	£834.78	£960.00
		-	-	-	•	£213.04	£245.00
2Z0	No rear model-inscription	•	•	•	-	No charge	No charge
2Z7	No rear capacity-inscription	•	•	•	•	No charge	No charge
PAA	Towing equipment – removable (factory-fitted towbars usually require a 13- to 7-pin adapter. Please consult your Audi Centre for advice on fitting this item)	•	•	•	-	£600.00	£690.00
7S1	Wind deflector	•	•	•	•	£195.65	£225.00
PX5	Xenon headlights – including headlight-cleaning system and automatic range-adjustment	•	•	•	•	£617.39	£710.00



Towing equipment



Acoustic hood



Wind deflector



Audi Centre-fitted Accessory Packs

Audi Centre-fitted Accessory Packs offer a range of products to let you tailor your A4 Cabriolet to your individual requirements. All prices include fitting where necessary.

Description	Contents	Basic RRP	Total RRP <small>inc. VAT</small>
<p>Protection Pack Safeguard the key areas of your A4 Cabriolet from everyday wear-and-tear with the Protection Pack.</p>	<ul style="list-style-type: none"> • Front mudflaps • Rear mudflaps • Front rubber mats • Bumper protection film 	£251.06	£295.00
<p>Premium Protection Pack Add further protection to your A4 Cabriolet with the Premium Protection Pack, which includes headlight protectors and a flexible boot load-liner in addition to the Protection Pack contents.</p>	<ul style="list-style-type: none"> • Front mudflaps • Rear mudflaps • Front rubber mats • Bumper protection film • Headlight protectors • Flexible boot load-liner 	£319.15	£375.00



Front rubber mats – part of Protection Packs



Flexible boot load-liner – part of Premium Protection Pack



Mud flaps – part of Protection Packs

Audi Centre-fitted Accessory Packs

Description	Contents	Basic RRP	Total RRP <small>inc. VAT</small>
<p>Road Angel The Road Angel Plus gives you access to the UK's number-one safety camera and accident blackspot database as you drive. Features include visual and spoken alerts for fixed, mobile and average speed safety cameras. Road Angel Plus also has a built-in rechargeable battery with 8-hour battery life and fully-integrated laser sensor to warn of laser speed guns and mobile safety camera vans.</p>	<ul style="list-style-type: none"> • Road Angel Plus 	£212.77	£250.00
<p>Security The security package comprises a TRACKER, which is a small electronic homing device discreetly fitted in your A4 Cabriolet. In the event of your car being stolen, TRACKER is activated and emits a silent signal which can be traced by all UK police forces.</p>	<ul style="list-style-type: none"> • TRACKER monitor* 	£327.66	£385.00
<p>Family Pack The family pack includes a RECARO® Start child seat which provides children from 9 months to 12 years of age (9-36kg) with all the safety and comfort of an adult seat, along with a speaker integrated into the headrest which allows them to listen to their own music without disturbing other passengers. There is also a practical, general-purpose storage bag attached to the seat backrest which can be taken out and folded up quickly and easily.</p>	<ul style="list-style-type: none"> • RECARO® Start G1-G3 child seat (9 months to 12 years) • Storage bag 	£217.02	£255.00



Road Angel Plus



RECARO® Start child seat



Storage bag

*Excludes subscription

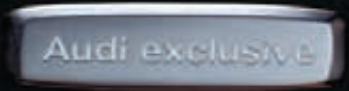

Every Audi is intrinsically exclusive. It's the breathtaking design, the exceptional engineering, the Vorsprung durch Technik. But for that added element of exclusivity – that distinguishing look that sets you apart from the rest – you can specify your A4 Cabriolet with options from Audi exclusive. Whether you want a completely unique, custom-mixed paint colour, seats in a combination of complementary shades or even individualised carpets and floor mats, Audi exclusive will enable you to drive the car you've always imagined.

For more information on any of the options over the following pages or to view swatches, simply ask a member of staff at your local Audi Centre.



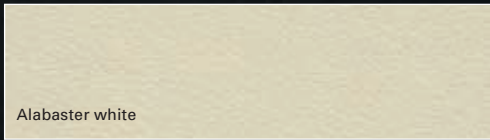

Alabaster white

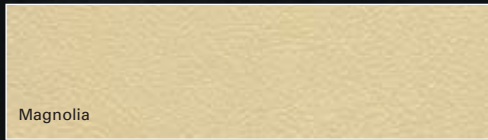

Magnolia



Sand beige



Havana brown



Cocos

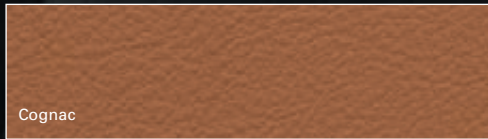

Cognac



Saddle brown



Chestnut brown



Crimson red*

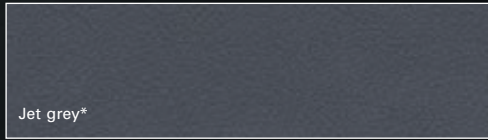

Jet grey*



Palace blue

Upholstery

With Audi exclusive, you can choose between Valcona leather and Alcantara/Fine Nappa leather, depending on the texture and flexibility you prefer in your car's upholstery. And once that's decided, you can specify your seats in an array of different colours shown to the left.

Choose just one all-over shade for each seat, or for a more exciting look, customise each panel in two or more complementary colours from the distinctive Audi exclusive palette shown here. You can even choose the colour of the decorative stitching – to match or contrast with your chosen upholstery – from this varied collection. Whatever combination you decide upon, you're guaranteed to be extremely comfortable with the result.

	Standard	Sport	S line	S4	Basic RRP	Total RRP ^{Incl VAT}
Fine Nappa leather	•	•	•	•	£3,200.00	£3,680.00
Fine Nappa leather / Alcantara	•	•	•	•	£3,200.00	£3,680.00

*Not available in Alcantara.

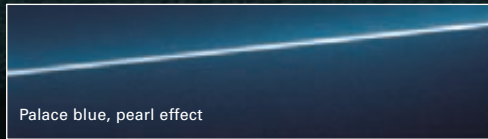

Palace blue, pearl effect

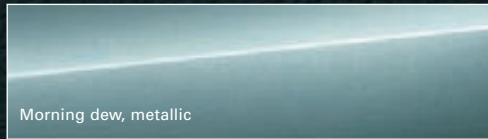

Morning dew, metallic

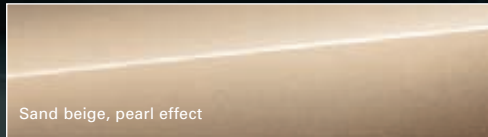

Sand beige, pearl effect

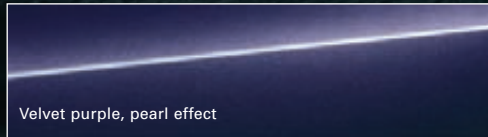

Velvet purple, pearl effect

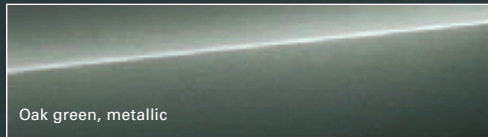

Oak green, metallic

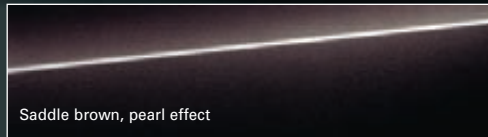

Saddle brown, pearl effect

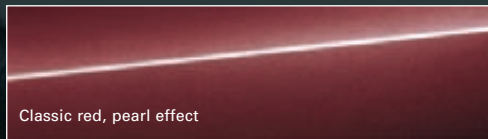

Classic red, pearl effect

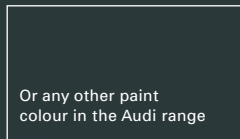

Or any other paint colour in the Audi range

Paint

Everyone has a favourite colour. No matter what yours is, Audi exclusive provides a range of unique colours that have been designed to set your car apart. Choose from the swatches here, or specify any other paint colour in the Audi range – whether it's Jet blue from the Audi R8 or Alpine white from the original Audi quattro®. The choice is yours.

	Standard	Sport	S line	S4	Basic RRP	Total RRP ^{incl. VAT}
Audi exclusive paint	•	•	•	•	£1,404.35	£1,615.00

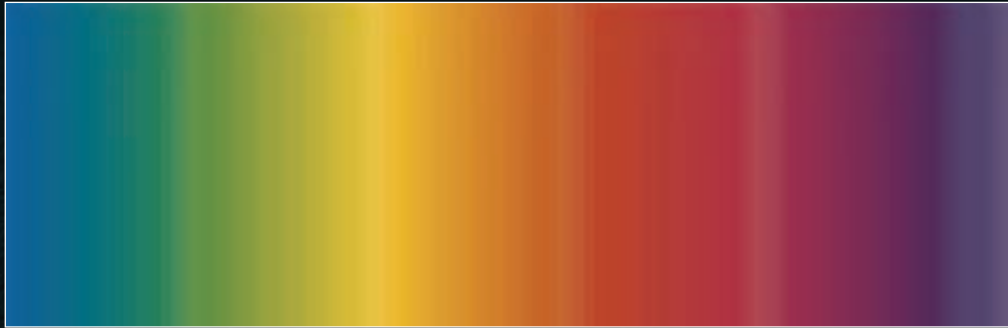

Customised paint

In a car made from Vorsprung durch Technik, there are no compromises. So if you have a particular colour in mind, we'll mix the exact water-based pearlescent or metallic-effect shade you want – whether it's the blue of your favourite shirt or the wall colour in your sitting room.

Basic RRP	Total RRP ^{inc.} _{VAT}
£2,000.00	£2,300.00

Steering wheels and controls pack

Our fingertips and palms contain more touch receptors than any other part of our body – so shouldn't the parts of our car we handle the most also be the most pleasing to touch? With this in mind, Audi exclusive enables you to customise the steering wheel of your choice in smooth, warm leather, in any of the colours shown on page 45. As with Audi exclusive seats, you even have free choice on the colour of the decorative stitching used. Choose a controls pack and you can extend this exclusive look and feel to your car's handbrake, gearknob and gaiter too.



	Standard	Sport	S line	S4	Basic RRP	Total RRP ^{incl} _{VAT}
Steering wheel	•	•	•	•	£304.35	£350.00
Controls pack	•	•	•	•	£556.52	£640.00

Carpets and floor mats

Exclusivity isn't just about choice and individuality – it's about attention to every detail in your A4 Cabriolet; and for us, that includes the carpets and floor mats. First, choose from nine different colours of high-quality velour carpets. Next, choose the colour of your car's floor mats from the same list, whilst using the palette of Audi upholstery colours detailed on page 43 to select a leather colour for the mats' decorative leather piping – matched or contrasting, depending on your personal taste. Floor mats are included when you order Audi exclusive carpet; but if you wish, floor mats can also be purchased separately in a set of four.



Carpet colours

- ▶ Alabaster white
- ▶ Magnolia
- ▶ Sand beige
- ▶ Havana brown
- ▶ Cocos
- ▶ Cognac
- ▶ Chestnut brown
- ▶ Palace blue
- ▶ Amethyst grey

	Standard	Sport	S line	S4	Basic RRP	Total RRP ^{incl} VAT
Carpets	•	•	•	•	£556.52	£640.00
Floor mats	•	•	•	•	£260.87	£300.00

Audi exclusive line

Audi exclusive is ultimately about choice – but if you'd rather leave some of the decisions in the capable hands of our designers, the expert team at quattro® GmbH have compiled Audi exclusive line, combining some of the most popular elements of the exclusive range in one sporty, beautifully co-ordinated package.

The package gives you:

- ▶ Sports seats in two-tone Fine Nappa leather, with black seat-side sections with coloured stitching and coloured seat-centre section in Crimson red, silver or Cognac
- ▶ Black dashboard and carpets
- ▶ Black cloth headlining
- ▶ Door-trim inserts in black to match interior trim
- ▶ Audi exclusive door sill trims
- ▶ Brushed Aluminium inlays
- ▶ Floor mats in black with coloured piping (to match seat-centre section)
- ▶ 3-spoke leather steering wheel (S tronic with shift paddles)
- ▶ Steering wheel rim and gear lever gaiter with coloured stitching in matching colour to seat-centre section
- ▶ Head restraints with coloured stitching in matching colour to seat-centre section



Cognac (OX)

	Standard	Sport	S line	S4	Basic RRP	Total RRP ^{incl} VAT
exclusive line package	●	–	–	–	£2,469.57	£2,840.00
	–	●	–	–	£2,034.78	£2,340.00



Crimson red (QY)



Silver (QL)



Technical data

Petrol

Engine	Cylinder	Displacement, cubic cm (valves per cylinder)	Max. power ¹ , PS at rpm	Max. torque, Nm at rpm	Transmission	CO ₂ emissions ² , g/km	0-62mph acceleration, seconds	Top speed, mph	ABI insurance group
1.8T	4-cylinder	1781 (5)	163 / 5700	225 / 1950-4700	5-speed manual	199	9.4	140	15E
1.8T	4-cylinder	1781 (5)	163 / 5700	225 / 1950-4700	7-speed multitronic®	204	9.3	136	15E
2.0 TFSI	4-cylinder	1984 (4)	200 / 5100-6000	280 / 1800-5000	6-speed manual	199	7.9	146	16E
2.0 TFSI	4-cylinder	1984 (4)	200 / 5100-6000	280 / 1800-5000	7-speed multitronic®	199	8.1	144	16E
3.2 FSI	V6	3123 (4)	256 / 6500	330 / 3250	7-speed multitronic®	229	7.2	155 ⁵	18E
3.2 FSI quattro®	V6	3123 (4)	256 / 6500	330 / 3250	6-speed manual	264	6.8	155 ⁵	18E
3.2 FSI quattro®	V6	3123 (4)	256 / 6500	330 / 3250	6-speed tiptronic®	266	7.4	155 ⁵	18E
S4 quattro®	V8	4163 (5)	344 / 7000	410 / 3500	6-speed manual	331	5.9	155 ⁵	20E
S4 quattro®	V8	4163 (5)	344 / 7000	410 / 3500	6-speed tiptronic®	302	6.2	155 ⁵	20E

Diesel

2.0 TDI	4-cylinder	1968 (4)	140 / 4000	320 / 1750-2500	6-speed manual	172	9.7	131	15E
2.0 TDI	4-cylinder	1968 (4)	140 / 4000	320 / 1750-2500	7-speed multitronic®	175	10.4	129	15E
3.0 TDI quattro®	V6	2967 (4)	233 / 4000	450 / 1400-3250	6-speed manual	209	7.3	150	17E
3.0 TDI quattro®	V6	2967 (4)	233 / 4000	450 / 1400-3250	6-speed tiptronic®	223	7.8	150	17E

¹The given value was obtained in accordance with the specified measurement procedure (the respective current version of the Directive 80/1269/EEC)

²The given values were calculated in accordance with the specified measurement procedure (the respective current version of Directive 80/1268/EEC). This information does not relate to a single vehicle and does not comprise part of the offer but is merely intended for the purpose of comparison between the different vehicle types

⁵Vehicle's unladen weight without driver (calculated in accordance with the current version of Directive 80/1268/EEC). The fitting of additional equipment may increase the vehicle's unladen weight and drag coefficient, whereupon the potential carrying capacity and top speed will be correspondingly reduced

Weights, kg			Max. trailer load ⁴ , kg			Volumes		Fuel tank capacity approx, litres	Fuel consumption, mpg (l/100km)		
Unladen weight ³	Gross weight limit	Roof load limit/nose weight	unbraked	with 12% gradient	with 8% gradient	Luggage compartment capacity, litres			Urban	Extra Urban	Combined
						Hood up	Hood down				
1540	2020	-/80	750	1400	1600	315	246	70	24.8 (11.4)	43.5 (6.5)	34.0 (8.3)
1580	2060	-/80	750	1500	1700	315	246	70	24.4 (11.6)	42.2 (6.7)	33.2 (8.5)
1600	2080	-/80	750	1400	1600	315	246	70	24.4 (11.6)	42.2 (6.7)	34.0 (8.3)
1630	2110	-/80	750	1500	1700	315	246	70	24.6 (11.5)	42.8 (6.6)	33.6 (8.4)
1660	2140	-/80	750	1700	1800	315	246	70	20.5 (13.8)	39.2 (7.2)	29.4 (9.6)
1695	2175	-/80	750	1800	1800	315	246	63	17.4 (16.2)	34.9 (8.1)	25.7 (11.0)
1740	2220	-/80	750	1800	1800	315	246	63	17.5 (16.1)	34.4 (8.2)	25.4 (11.1)
1855	2315	-/-	N/A	N/A	N/A	315	246	63	14.2 (19.9)	27.4 (10.3)	20.5 (13.8)
1895	2355	-/-	N/A	N/A	N/A	315	246	63	15.5 (18.2)	30.1 (9.4)	22.4 (12.6)

1600	1980	-/80	750	1600	1800	315	246	70	33.6 (8.4)	53.3 (5.3)	44.1 (6.4)
1600	2080	-/80	750	1600	1800	315	246	70	34.9 (8.1)	50.4 (5.6)	43.5 (6.5)
1790	2270	-/80	750	1800	1800	315	246	63	25.4 (11.1)	47.1 (6.0)	35.8 (7.9)
1815	2295	-/80	750	1800	1800	315	246	63	23.7 (11.9)	44.1 (6.4)	33.6 (8.4)

³The engine's power output always goes down with increasing altitude. At 1,000m above sea level, and for every additional 1,000m, deduct 10% from the weight of the outfit (trailer load limit + gross weight of the towing vehicle).

⁴Regulated

Dimensions

A4 Cabriolet

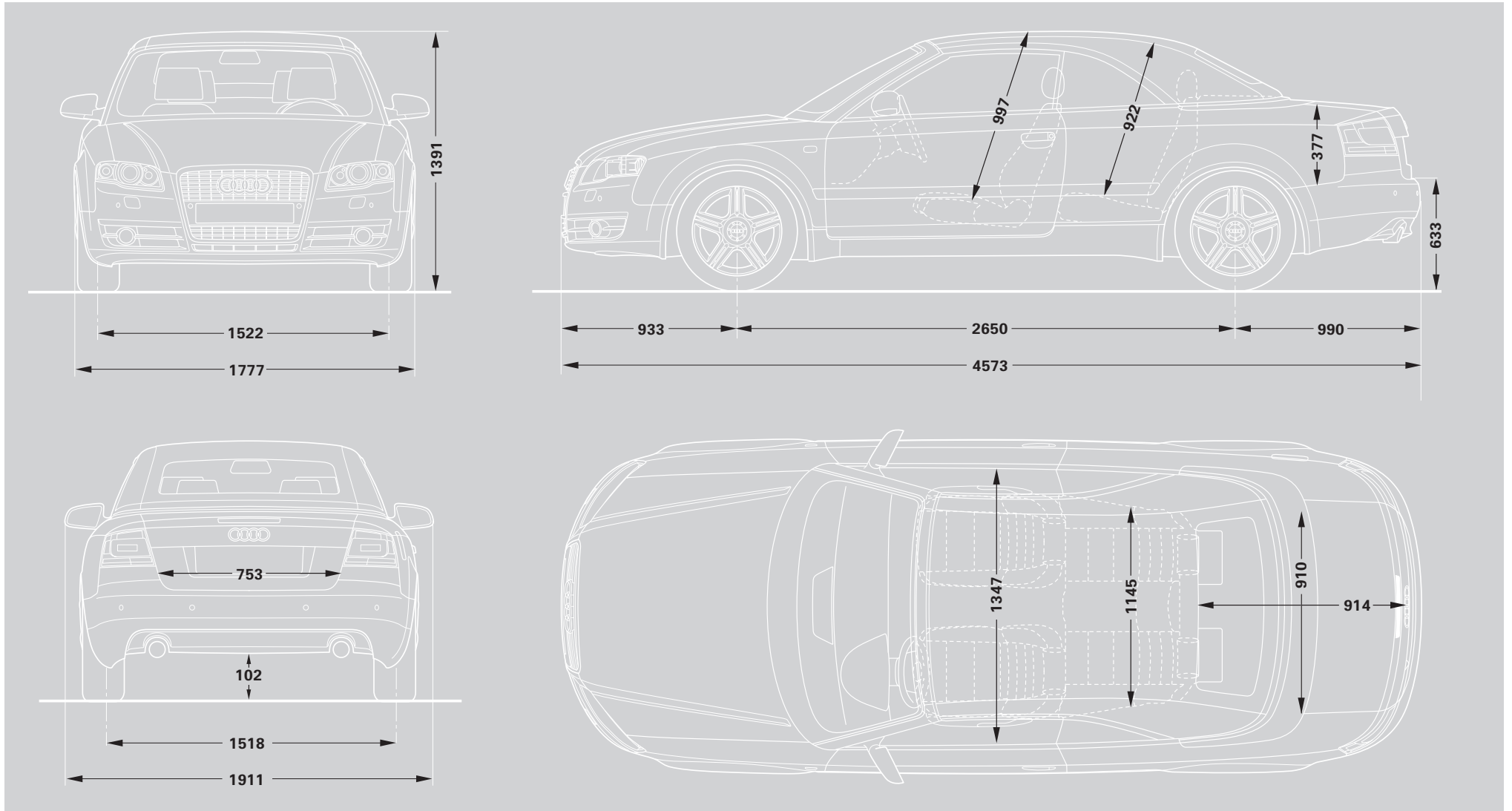

Dimensions were measured with vehicle at unladen weight, ground clearance measured with vehicle carrying its maximum load. Luggage compartment volume in litres: 315/246 (as measured by the VDA standard test method using 200 x 100 x 50 mm blocks; First value: closed hood; Second value: open hood). Turning circle approx 11.1 metres

Dimensions in millimetres

Dimensions

S4 Cabriolet quattro®

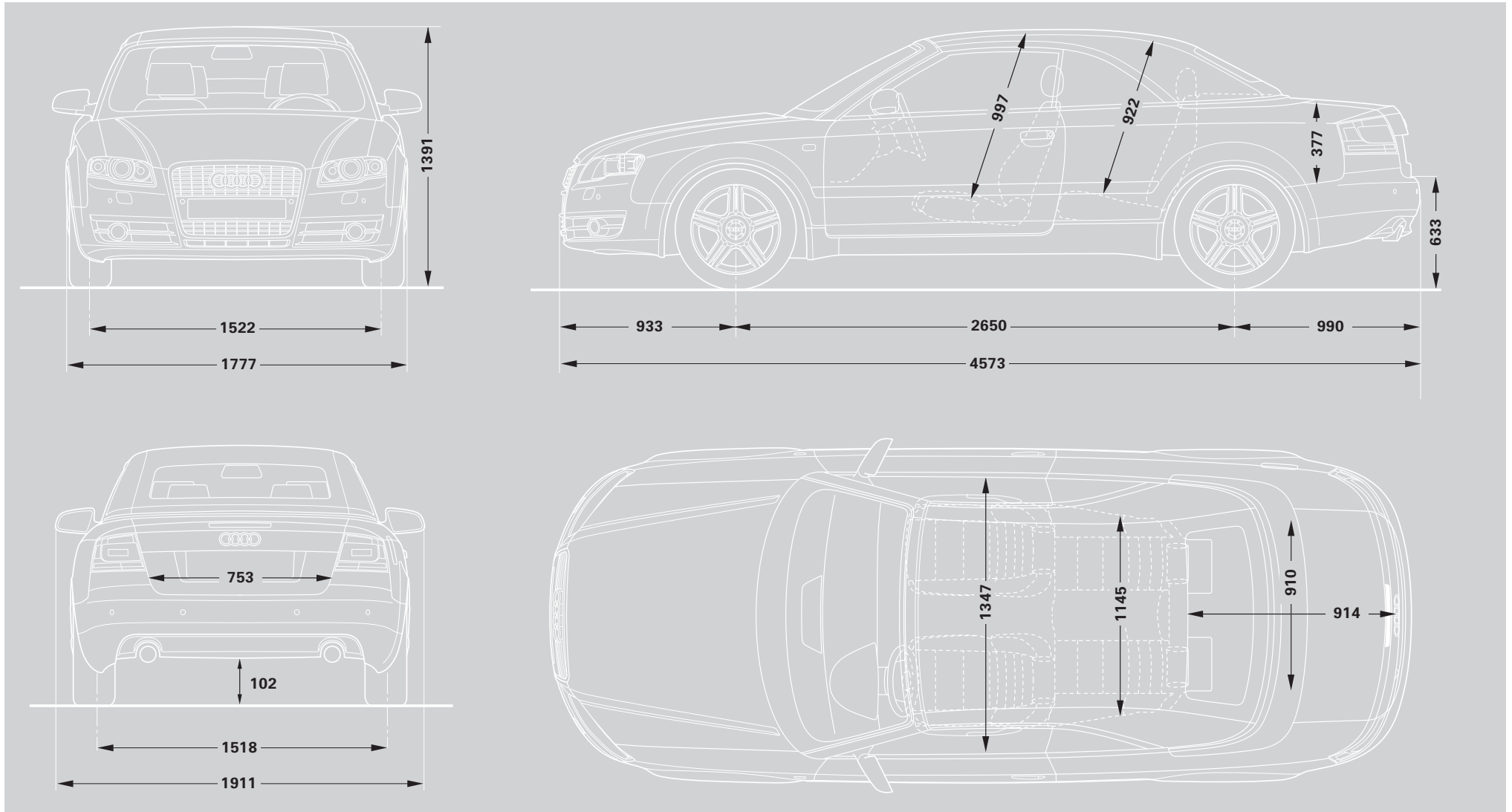

Dimensions were measured with vehicle at unladen weight, ground clearance measured with vehicle carrying its maximum load. Luggage compartment volume in litres: 315/246 (as measured by the VDA standard test method using 200 x 100 x 50 mm blocks; First value: closed hood; Second value: open hood). Turning circle approx 11.1 metres

Dimensions in millimetres

Additional information

CO₂ data and information

CO₂ emissions-based Vehicle Excise Duty

Vehicle Excise Duty (Road Fund Licence) is based upon the amount of Carbon Dioxide (CO₂) a vehicle emits, measured in grams per kilometre (g/km). The DVLA has created seven categories:

Petrol and Diesel engines	
A – up to 100g/km	£0.00
B – 101 to 120g/km	£35.00
C – 121 to 150g/km	£120.00
D – 151 to 165g/km	£145.00
E – 166 to 185g/km	£170.00
F – 186 to 225g/km	£210.00
G – over 225g/km	£400.00

Audi Service

Servicing tailored to your needs

Regular servicing is key to safeguarding your Audi's performance and a full Audi service history could help you preserve the future re-sale value. To make servicing easy, the Audi Service Schedules have been designed to work with your individual driving style and vehicle.

There are two schedules available and your Audi Centre will advise which schedule is most suited to your needs. The conventional fixed Audi Inspection Service schedule

Inspection Service Schedule

Vehicle usage:	
Mileage	Less than 10,000* miles per annum
Type of journey	Mainly city/town centre driving. Short journeys
Conditions	Frequent cold starts. High engine loading – e.g. frequent hill climbs, vehicle fully loaded, towing
Driving style	Uneconomical – e.g. heavy acceleration, heavy braking, constant changes in speed, constant use of high revs, 'sporty' driving

Fixed Audi Inspection Service Intervals:	
Oil-change Service	Fixed to every 10,000* miles/1 year
Inspection Service	Fixed to every 20,000* miles/3 years, then every 20,000* miles/2 years thereafter

has fixed intervals for the Oil Change and Inspection Service that are based on time and distance, whichever comes first. With the Audi LongLife Service schedule, sensors take account of driving style and conditions in which the vehicle is used to indicate when the Oil Change Service is required. Oil Change Service intervals are therefore variable and are conveniently indicated via the on-board service interval display.

LongLife Service Regime

Vehicle usage:	
Mileage	More than 30 miles per day
Type of journey	Motorway and main road driving. Mainly longer distance journeys. Constant speeds
Conditions	Normal engine loading – e.g. with little or no towing, with little or no hill climbs. Normal vehicle loading
Driving style	Moderate acceleration, moderate braking, engine revs mainly below 3,000

Audi LongLife Service Intervals:	
Oil-change Service	Variable to a maximum of every 20,000* miles/2 years
Inspection Service	Fixed to every 20,000* miles/3 years, then every 20,000* miles/2 years thereafter

*As indicated by the service interval display. Mileages are approximate as the Service Indicator system uses kilometres as its distance measurement.

Service by Design

At Audi, we believe our customers have the right to expect excellent service each and every time they make contact with us. To ensure that this happens, we have agreed a set of service standards with our Audi Centre network that governs the way they do business with you. These standards apply to both Sales and Aftersales, and we actively monitor our Centres to ensure that you receive the highest level of customer service. These service standards will ensure a consistent, stress-free experience whenever you are in contact with anyone representing the Audi brand.

Every Audi Centre will be open during the following hours:

Sales: 9am-6pm Monday to Friday
9am-5pm Saturday

Service: 8am-6pm Monday to Friday
8.30am-1pm Saturday

Sunday opening at local discretion.

Test drives

Whilst we cannot always have the desired demonstrator car ready immediately, we will confirm arrangements for a test drive within two working days (subject to status).

New car delivery

Once we have confirmed a delivery date with you, we will keep you informed of progress. In the unlikely event of a delay, we will provide you with a courtesy car to minimise inconvenience and keep you mobile.

Delivery to any location within the UK

To maximise your Audi experience right from the first day of ownership, we will deliver your car to your preferred location – whether that's home or your place of work (subject to reasonable notice).

Every attention to detail

Your ownership experience starts with half a tank of fuel.

Quotation response

We are committed to answering any quotation request within 1 working day.

Training

We run a continuous training development programme for all our staff so that we consistently deliver a high-quality, professional service.

Formal complaints procedure

We have a complaints procedure designed to ensure any negative issue you raise with us is dealt with properly.

Courtesy cars

When your car is off the road, perhaps due to a scheduled service or MOT, we will offer you an Audi Courtesy Vehicle until yours is ready. We'll even collect from and deliver to your chosen location, keeping hassle to an absolute minimum.

Service bookings

If you do not require a courtesy car, we will service your Audi within a maximum of 5 working days. If you do choose to take a courtesy car, we will promise to service your vehicle within a maximum of 10 working days.

Cleaning

When your car comes to our workshop, we will wash and vacuum it at no extra cost.

No hidden charges

You will be consulted before we carry out any necessary work on your vehicle, and anything charged for will be itemised on your bill. No extra work will be undertaken without your permission.

A personal service

All work will be done by a named Audi Technician, to whom you can personally direct questions or requests should you need to.

Environmental commitment

We promise to dispose of all non-biodegradable materials from your vehicle in a responsible manner.



Pricing information

Pricing

Prices and specifications given are correct at the time of printing. Always check details with your Audi Centre, as Audi policies are continually developing. We reserve the right to change prices or specifications at any time.

All prices are subject to VAT, currently charged at 15%.

Delivery charges and number plates are not included in the vehicle price.

Delivery charge	£471.30
Number plates	£20.00
VAT	£73.70
Total	£565.00

Audi Roadside Assistance

Your new car comes complete with complimentary roadside assistance and recovery across the UK provided by RAC Motoring Services. Also included is roadside assistance throughout Europe, managed by RAC Motoring Services.

Audi Customer Care

Every new Audi benefits from the comprehensive Audi Customer Care Package, which comprises:

- ▶ A 3-year Audi warranty, which covers you for unlimited mileage in the first 2 years of ownership, with a full mechanical and electrical warranty which covers you for up to 60,000 miles in the 3rd year
- ▶ A 3-year paint warranty
- ▶ A 12-year anti-corrosion warranty
- ▶ Up to 3 years' UK roadside assistance and recovery

This package, together with Audi variable Service intervals, offers a combination unmatched by any other major manufacturer. Contact your Audi Centre for full details.

Audi Tax-Free Sales

If you are entitled to purchase a vehicle free of VAT, normally through military or diplomatic privilege, please contact your local Audi Centre for full details. Should you have any difficulty obtaining the information you require, please call Freephone 0800 585878.

Audi Finance

Audi Finance specialise in providing funding solutions for Audi drivers. Whether your Audi is for private or business use, there are a range of funding options to choose from. Below is the full range of finance products.

- ▶ Solutions – a Personal Contract Plan
- ▶ Hire purchase
- ▶ Lease purchase
- ▶ Finance lease
- ▶ Contract hire

With all products, you can choose a fixed-cost maintenance plan designed to help you budget accurately.

No matter what Audi model you choose, your local Audi Centre can provide you with a personalised quote which could fit your budget and motoring needs.

Audi Finance is a trading name of Volkswagen Financial Services (UK) Limited. An offer of finance depends on certain conditions. Available to people over 18 in the UK only.

Audi Insurance

Competitive comprehensive motor insurance designed specially for Audi drivers. All new Audi models come with complimentary seven-day cover upon request – we'll email a cover note directly to your Audi Centre, enabling them to tax your car easily. This way, you can drive straight out of the showroom. Taking out an annual policy is easy and can begin as soon as your free seven-day cover expires.

For more information, contact your local Audi Centre. Alternatively, call 0800 051 3146 for a quote and to receive 7 days' complimentary cover for your new Audi.

Audi Insurance is underwritten and administered by Zurich Insurance Company.

Audi UK
Customer Services
Selectapost 29
Sheffield
S97 3FG
0800 699888
www.audi.co.uk

Specifications and prices subject
to change without notice.

© Audi UK

Printed in the UK
Edition 2.0. 12/08
2008 model year



Mixed Sources
Product group from well-managed
forests and other controlled sources

Cert no. TT-COC-002327
www.fsc.org
© 1996 Forest Stewardship Council