



The Audi A5 and S5 Sportback

Pricing and Specification Guide
Valid from December 2009

Personalising your Audi A5 Sportback

This guide has been designed to help you tailor and price your Audi A5 Sportback quickly and logically. At the back, you will also find information on CO₂ emissions-based vehicle excise duty and other services offered by Audi, including Finance and Insurance. Alternatively, you can go to audi.co.uk and configure your Audi A5 Sportback online.

Audi A5 Sportback

Efficiency	8
Engine	10
Transmissions	11
quattro®	12

Model details and prices

Standard model equipment	14
SE model equipment	16
S line model equipment	17
S5 model equipment	18
Model prices	20

Audi exclusive	22
-----------------------	----

Colour and upholstery

Paint	26
Upholstery	28
Colour and trim guide	32
Inlays	36

Options

Wheels, tyres and suspension	38
Audio and communication	40
Steering wheels	42
Safety and security	44
Interior equipment	46
Seats	48
Exterior equipment	49
Warranty extensions	49
Merchandise	50
Accessories	51

Technical details

Technical data	52
Dimensions	54
Additional information	56
Pricing information	58





Vorsprung durch Technik

Three words that express the very essence of Audi. Vorsprung durch Technik isn't a slogan. It's our way of seeing the world. It is the driving force behind our history of innovation that continues into the 21st century. Indeed, many technologies that Audi pioneered remain in our cars today. Some are milestones in the history of the motorcar.

From our beginnings in 1899, to the Auto Union team's Grand Prix successes in the 1930s and our more recent wins at Le Mans, we have always been at the forefront of the motor industry.

Vorsprung durch Technik makes us who we are. To see more of its influence, just read on.

The Audi A5 Sportback: think of it as a coupé with doors

It's the first mid-size Sportback in the Audi range, an exciting milestone in design. But even in a pioneer like the Audi A5 Sportback, it's rare to find such a balance of different qualities. Its elegant lines and accentuated wheel arches are influenced heavily by the iconic A5 Coupé, while it provides the comfort and practicality of a larger family car. It also comes with several different engine options - TDI®, FSI® and TFSI® - all incorporating fuel-efficient direct-injection technology.





Efficiency

At Audi, doing less is something we're trying to do more of. We're working to use less fuel, release less CO₂ and waste less energy. It's why we've incorporated a number of more efficient technologies into the Audi A5 Sportback.

Recuperation

When a vehicle brakes, the discs convert the kinetic energy into thermal energy, which is wasted as it cannot be used. With a recuperation system, like the one in the Audi A5 Sportback, the kinetic energy is converted into useful electrical energy. The way it works is simple. While the car is coasting or braking, the alternator voltage is raised above the level of the basic electrical system, which enables the alternator to generate electrical energy and store it temporarily in the battery. When the vehicle accelerates, this energy is used to relieve the load on the alternator, resulting in a fuel saving of up to 3%.

Automatic Start-Stop function

In heavy traffic, your car still uses fuel and releases CO₂, even when it's stationary. The automatic Start-Stop function counteracts this problem by switching off the engine when your car comes to a standstill. As soon as you touch the clutch, the car restarts. In conjunction with TDI® and TFSI®, it helps save 0.4 litres of fuel every 100km.





Aerodynamics

A car's shape can have a big impact on its efficiency. It's why we've worked to make the Audi A5 Sportback as aerodynamic as possible.

Efficiency programme

The Driver's Information System in the Audi A5 Sportback is available with a special efficiency programme, which offers up-to-the-minute advice on ways you can improve fuel economy as you drive. It also shows you which items in your car are using energy, and how much they are using, so you can make an informed choice about which ones to switch off.

Engines

Petrol

FSI® direct-injection technology is a unique Audi innovation that was originally developed for the Le Mans 24-hour endurance race to deliver more power and torque, as well as enhanced fuel efficiency. Precisely the right amount of fuel and air are injected into the combustion chambers, enabling the engine to 'breathe' more easily. It results in reduced heat loss and increased output, with around a 15% reduction in fuel consumption and significantly lower exhaust emissions. We've also developed TFSI®, with either turbocharging or supercharging, which combines FSI® technology with forced induction – giving cars an extra injection of power.

Diesel

We introduced TDI® to the roads in 1989, marking a departure from the noisy, fuel-thirsty diesel engines of the past. And since then, we've continuously refined it, recently developing common-rail technology. Under this system, a series of piezo injectors use electrical charge to precisely control the amount of fuel injected into the engine. As well as reducing noise, this allows combustion to happen at a lower temperature, with less oxygen, which cuts down emissions.





Transmissions

multitronic®

Translating a driver's preferences and intentions into road performance, the multitronic® transmission system entertains no compromises – whether in terms of dynamism, convenience or economy. multitronic® automatic transmission is available on models without quattro® permanent all-wheel-drive. A continuously variable transmission, multitronic® can transmit up to 400 Nm of torque and permits an exceptionally wide range of gear ratios. The result is smooth, powerful acceleration and a high level of driving comfort. And thanks to its lightweight design and a number of advanced electronic control systems that monitor gradient, road conditions and the way the driver is using the accelerator pedal, multitronic® also plays an instrumental role in reducing fuel consumption.

S tronic®

Driving is all about thinking ahead, which is just what the S tronic® dual-clutch transmission does. It works almost as two separate systems, one engaging the odd-numbered and the other the even-numbered gears. So when you're accelerating in second, it has third gear waiting for you. And once you make the switch, it's already thinking about fourth. With two clutches working together, you can change gears almost instantly while experiencing smooth, uninterrupted power.

quattro®

It's the technology that has given Audi the edge on the racetrack ever since it was first introduced over 25 years ago – a technology that delivers ultimate control whilst enhancing the sporty characteristics which make the Audi A5 Sportback so thrilling to drive. It's called quattro® permanent all-wheel-drive. The principle is simple: in the same way that four brakes ensure better deceleration, four permanently-driven wheels deliver better acceleration and road-holding, pushing or pulling the car as needed, for a driving experience that's both dynamic and safe.

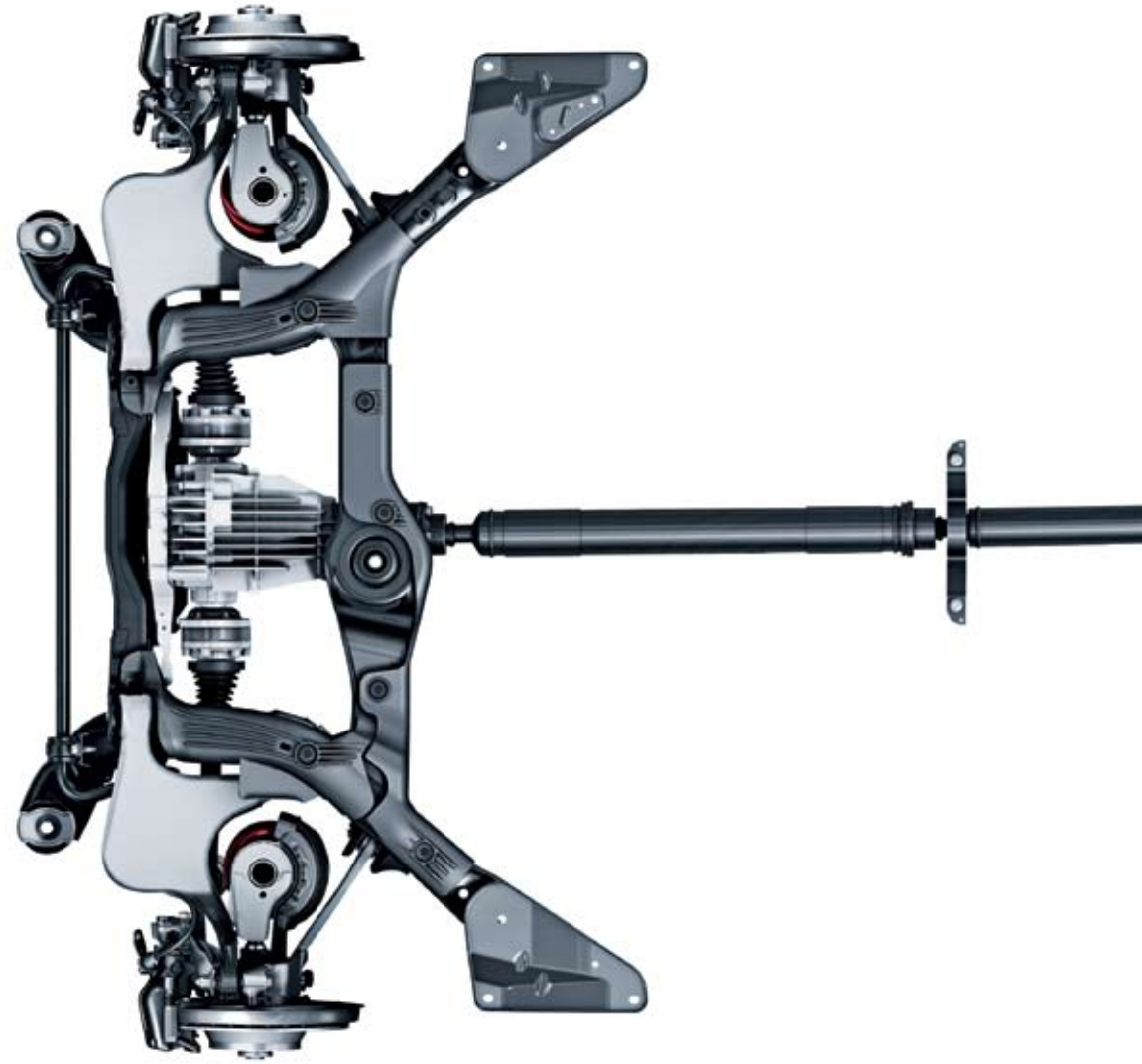

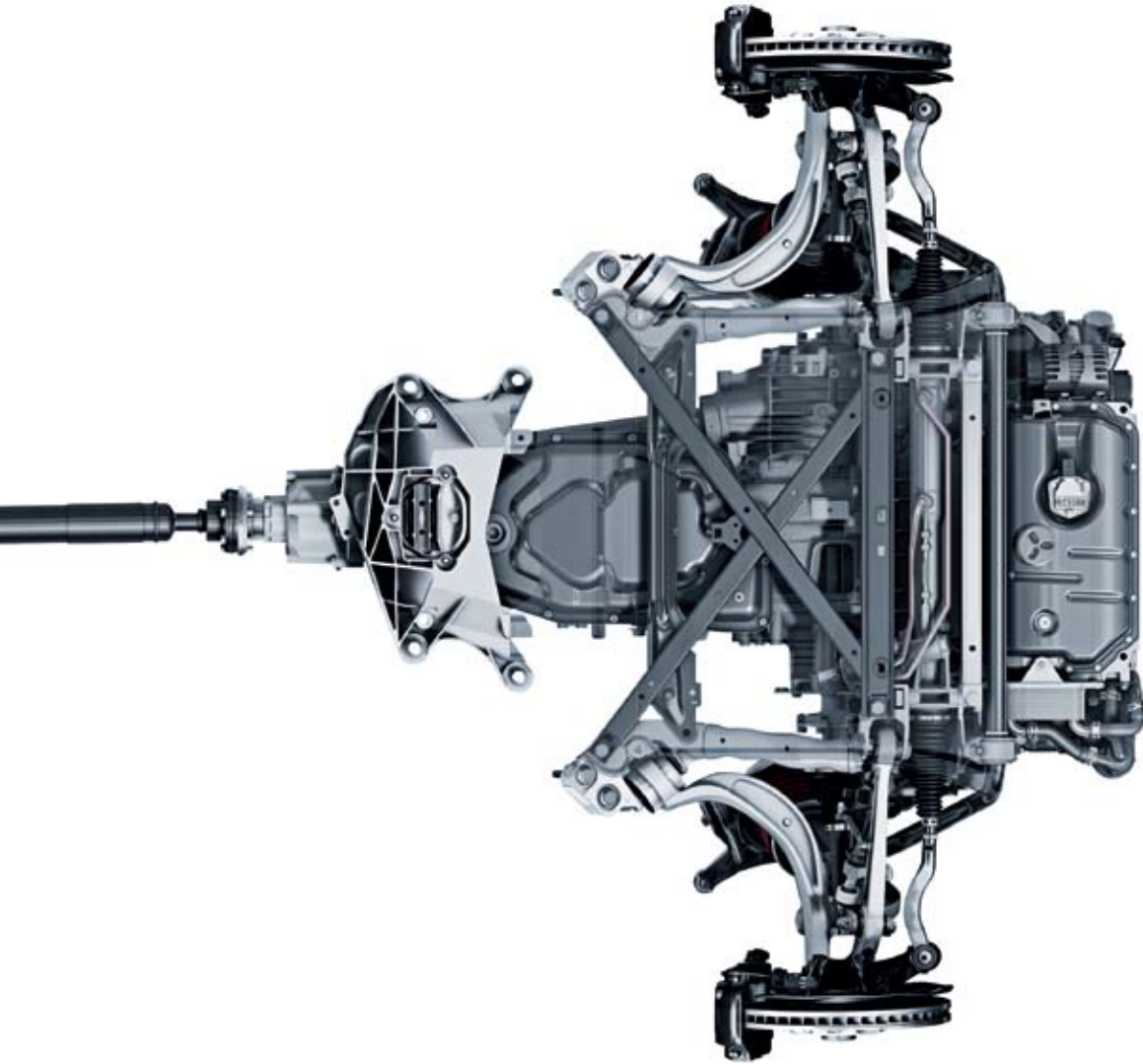

In the Audi A5 Sportback asymmetric dynamic torque distribution continuously distributes drive power between the front and rear axles depending on weather conditions, road surface and gradient, which increases flexibility for an enhanced, sportier drive.

Standard model equipment

All new A5 Sportback models have the following items of standard equipment

Engines

Automatic Start-Stop function for greater fuel and CO₂ efficiency. Comprising:

- Recuperation for optimal energy utilisation
- Energy-saving tips feature in Driver's Information System; including gearshift indicator

(Only available on the 2.0 TFSI® and 2.0 TDI® manual engines)

Wheels, tyres and suspension

17" x 7.5J '6-arm' design alloy wheels with 225/50 R17 tyres and locking wheel bolts

Space-saving spare wheel

Audio and communication

Audi Concert audio system. Single CD with MP3 compatibility, colour centre console screen, SD memory card reader and AUX-IN socket in centre console
6 speakers

Safety and security

ESP

First aid kit

Front and rear fog lights

Front and rear ISOFIX preparation with front passenger airbag de-activation switch

Front side airbags

Halogen daytime running lights

Headlight range adjustment

Thatcham category 1 alarm and immobiliser

Toolkit and car jack

Warning triangle

Seats

Arcade cloth seats

Split-folding rear seat

Interior equipment

1-zone climate control

3-spoke leather steering wheel

Driver's Information System (DIS)

Electric windows

Electromechanical parking brake

Front and rear floor mats

Intelligent key

Micrometallic inlays

Steering column adjustment for rake and reach

Interior chrome package

Exterior equipment

Exterior mirrors – electrically operated and heated

Front grille – Black gloss on 3.2 FSI® and 3.0 TDI® quattro® models, Stone grey on all others

Exhaust pipes – 4-cylinder models have two exhaust pipes on the left-hand side. 6-cylinder and 2.0 TFSI® models have one exhaust pipe on either side



17" x 7.5J '6-arm' design alloy wheels



Audi Concert audio system



Split-folding rear seat

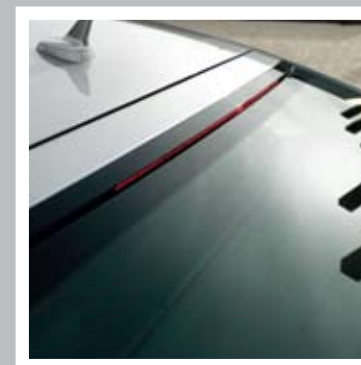

LED high level brake light



SE model equipment

In addition to Standard model equipment

Optional colours

Basic RRP

£1,476.60

Total RRP inc VAT

£1,735.00

Wheels, tyres and suspension

17" x 7.5J '7-arm' design alloy wheels with 225/50 R17 tyres and locking wheel bolts

Audio and communication

Audi sound system speaker package, 10 speakers including subwoofer (180 Watts)

Safety and security

Rear parking sensors
Automatic headlight operation (6-cylinder models only)
Automatic windscreen wipers (6-cylinder models only)

Seats

Milano leather seats

Interior equipment

3-spoke leather multi-function steering wheel (paddle shift for automatic models)

1-zone climate control – 4-cylinder models

Deluxe 3-zone climate control with separate air distribution and digital display for driver and front passenger. System includes air-conditioning controls in the rear centre console for rear passenger compartment – 6-cylinder models

Colour Driver's Information System (DIS)

Front centre armrest including 2 x 12V power sockets



17" x 7.5J '7-arm' design alloy wheels



Colour Driver's Information System (DIS)

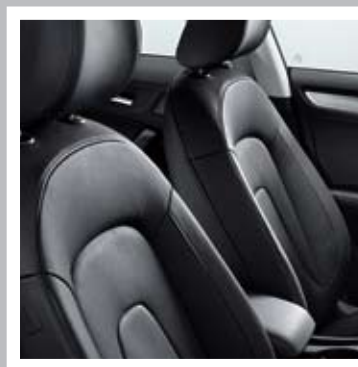

Milano leather seats

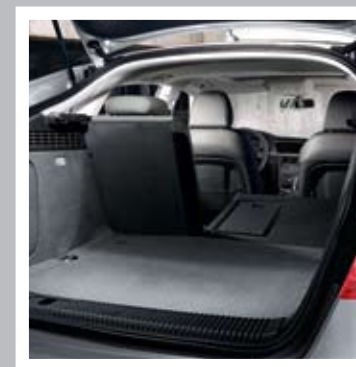

Split-folding rear seat

S line model equipment

In addition to SE model equipment

Optional colours

Basic RRP

£1,914.89

Total RRP inc VAT

£2,250.00

Wheels, tyres and suspension

18" x 8J '5-arm' S line design alloy wheels with 245/40 R18 tyres and locking wheel bolts

Sports suspension with shorter spring settings and shock absorbers (S line Sports suspension available at no charge)

Interior equipment

3-spoke S line multi-function steering wheel (paddle shift for automatic models)

Black headlining

Matt brushed aluminium inlays

Perforated leather gear knob

S line embossed Sports seats in Milano leather

S line sill plates

Exterior equipment

Bumper 'blade' in platinum optic

Chrome fog light surround

Chrome rolled exhaust

S line exterior styling package including:

- S line side skirts
- S line front bumper
- S line rear diffuser
- S line badges on wings

Xenon headlights with LED front lights and LED rear lights



18" x 8J '5-spoke' S line design alloy wheels



3-spoke S line multi-function steering wheel



Perforated leather gear knob

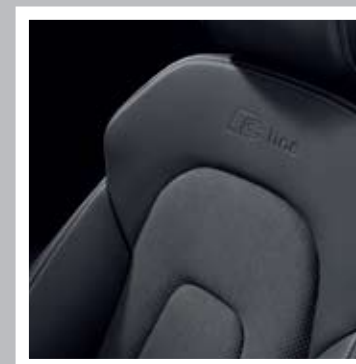

S line embossed Sports seats in Milano leather



S5 Sportback model equipment in addition to SE model equipment

One look at its muscular body styling, 19" alloy wheels and subtle S5 badging, and it'll come as no surprise that the Audi S5 Sportback features a powerful 3.0 litre TFSI® V6 engine, capable of taking you from 0 to 62mph in 5.4 seconds. And from the comfort and stability of a stylish Silk Nappa leather Sports seat, you can sit back and enjoy every single unit of this engine's 333PS capability – not to mention the safety and security of quattro® permanent all-wheel-drive.

Wheels, tyres and suspension

19" x 8.5J '5-parallel-spoke' design alloy wheels with 255/35 R19 tyres
'S' Sports suspension

Safety and security

'S' model enhanced braking system

Interior equipment

3-spoke 'S' Sports multi-function leather steering wheel with silver stitching and paddle shifts
Aluminium scuff plates with S5 logo
Interior lighting package
Inlays in matt-brushed aluminium
'S' instrument dials

Seats

S5 Super Sports seats with electric adjustment and lumbar support
Silk Nappa leather upholstery

Exterior equipment

Aluminium-look door mirror housings
Exhaust pipes – twin on left- and right-hand side in chrome rolled finish
Platinum grey matt grille, with vertical bars and chrome inserts
Painted brake callipers with S5 logo
'S' body styling



19" x 8.5J '5-parallel-spoke' design alloy wheels



'S' instrument dials



Platinum grey matt grille, with vertical bars and chrome inserts

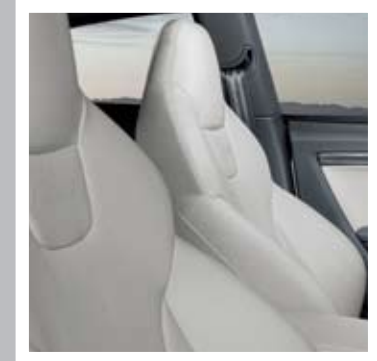

S5 Sportback Super Sports seats



A5 Sportback Standard

Engines	Power	Transmissions	Basic RRP	Total RRP inc VAT	Recommended OTR
2.0 TFSI	180PS	6-speed manual	£19,948.94	£23,440.00	£24,225.00
2.0 TFSI	180PS	multitronic	£21,182.98	£24,890.00	£25,700.00
2.0 TFSI	211PS	6-speed manual	£21,689.36	£25,485.00	£26,270.00
2.0 TFSI quattro	211PS	6-speed manual	£22,961.70	£26,980.00	£27,790.00
2.0 TFSI quattro	211PS	7-speed S tronic	£24,195.74	£28,430.00	£29,240.00
2.0 TDI	170PS	6-speed manual	£21,476.60	£25,235.00	£25,990.00
2.0 TDI quattro	170PS	6-speed manual	£22,748.94	£26,730.00	£27,515.00

A5 Sportback SE

Engines	Power	Transmissions	Basic RRP	Total RRP inc VAT	Recommended OTR
2.0 TFSI	180PS	6-speed manual	£21,425.53	£25,175.00	£25,960.00
2.0 TFSI	180PS	multitronic	£22,659.57	£26,625.00	£27,435.00
2.0 TFSI	211PS	6-speed manual	£23,165.96	£27,220.00	£28,005.00
2.0 TFSI quattro	211PS	6-speed manual	£24,438.30	£28,715.00	£29,525.00
2.0 TFSI quattro	211PS	7-speed S tronic	£25,672.34	£30,165.00	£30,975.00
3.2 FSI quattro	265PS	7-speed S tronic	£28,761.70	£33,795.00	£34,645.00
2.0 TDI	170PS	6-speed manual	£22,953.19	£26,970.00	£27,725.00
2.0 TDI quattro	170PS	6-speed manual	£24,225.53	£28,465.00	£29,250.00
2.7 TDI	190PS	multitronic	£26,165.96	£30,745.00	£31,555.00
3.0 TDI quattro	240PS	6-speed manual	£27,655.32	£32,495.00	£33,305.00
3.0 TDI quattro	240PS	7-speed S tronic	£28,889.36	£33,945.00	£34,755.00

Please note: The maximum power output figures are quoted in PS (or Pferdestärke, which is the metric equivalent of brake horsepower). To convert to brake horsepower, divide the PS figure by 1.0139.

Recommended On-The-Road (OTR) retail prices include: delivery charge, half a tank of fuel, number plates at £580.00 (inc. VAT), Road Fund Licence (which may vary depending on model/transmission – see page 56 for details) and first registration fee at £55.00.

RRP – Recommended Retail Price. VAT is calculated at 17.5% but this may alter to reflect any change in the applicable VAT rate.

A5 Sportback S line

Engines	Power	Transmissions	Basic RRP	Total RRP inc VAT	Recommended OTR
2.0 TFSI	180PS	6-speed manual	£23,340.43	£27,425.00	£28,210.00
2.0 TFSI	180PS	multitronic	£24,574.47	£28,875.00	£29,685.00
2.0 TFSI	211PS	6-speed manual	£25,080.85	£29,470.00	£30,255.00
2.0 TFSI quattro	211PS	6-speed manual	£26,353.19	£30,965.00	£31,775.00
2.0 TFSI quattro	211PS	7-speed S tronic	£27,587.23	£32,415.00	£33,225.00
3.2 FSI quattro	265PS	7-speed S tronic	£30,676.60	£36,045.00	£36,895.00
2.0 TDI	170PS	6-speed manual	£24,868.09	£29,220.00	£29,975.00
2.0 TDI quattro	170PS	6-speed manual	£26,140.43	£30,715.00	£31,500.00
2.7 TDI	190PS	multitronic	£28,080.85	£32,995.00	£33,805.00
3.0 TDI quattro	240PS	6-speed manual	£29,570.21	£34,745.00	£35,555.00
3.0 TDI quattro	240PS	7-speed S tronic	£30,804.26	£36,195.00	£37,005.00

S5 Sportback

Engine	Power	Transmissions	Basic RRP	Total RRP inc VAT	Recommended OTR
3.0 TFSI quattro	333PS	7-speed S tronic	£32,544.68	£38,240.00	£39,090.00

Transmissions

	7-speed S tronic transmission	8-speed multitronic transmission	6-speed manual
2.0 TFSI 180PS	-	•	S
2.0 TFSI 211PS	-	-	S
2.0 TFSI 211PS quattro	•	-	S
3.0 TFSI 333PS quattro	S	-	-
3.2 FSI quattro	S	-	-
2.0 TDI quattro 170PS	-	-	S
2.7 TDI	-	S	-
3.0 TDI quattro	•	-	S
Basic RRP	£1,234.04	£1,234.04	No cost
Total RRP inc VAT	£1,450.00	£1,450.00	No cost

- = Not available • = Available S = Standard

RRP – Recommended Retail Price. VAT is calculated at 17.5% but this may alter to reflect any change in the applicable VAT rate.



Audi exclusive



Audi exclusive

Every Audi is intrinsically exclusive. It's the breathtaking design, the exceptional engineering, the Vorsprung durch Technik. But for that special touch you can specify your new Audi A5 Sportback with options from Audi exclusive. Whether you want a unique, custom-mixed paint colour or seats in a combination of complementary shades, Audi exclusive will enable you to drive the car you've always imagined.

Both the exclusive and standard options can be found on the following pages.

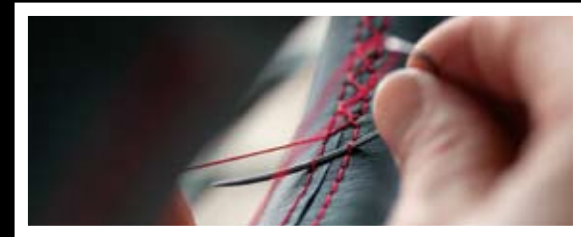

Audi exclusive line





Paint

You can select the standard Ibis white, Brilliant red or Brilliant black colours shown opposite or, for a different look, choose from the range of optional finishes.

Options are subject to availability and may extend delivery.

All the colour swatches on this page are matched as accurately as possible to the actual paint colours used. However, due to print processes, Audi UK cannot guarantee that colours shown are 100% accurate.

Visit your local Audi Centre for a more accurate colour swatch.

*Not available on S5 Sportback

RRP – Recommended Retail Price.

VAT is calculated at 17.5% but this may alter to reflect any change in the applicable VAT rate.

Standard colours



Ibis white – T9

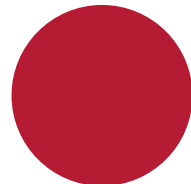

Brilliant red – C8

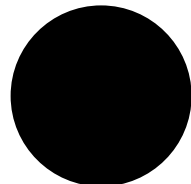

Brilliant black – A2

Optional colours

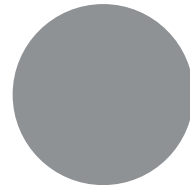

Ice silver, metallic – P5

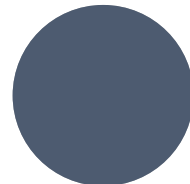

Condor grey, metallic* – 5Q

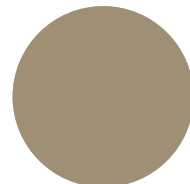

Dakar beige, metallic* – 9X

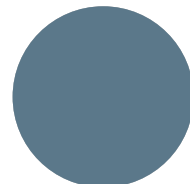

Sphere blue, metallic* – 9F

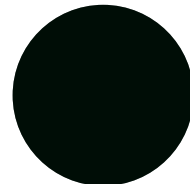

Deep green, pearl effect* – 3W

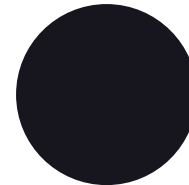

Tungsten grey, metallic* – 1J

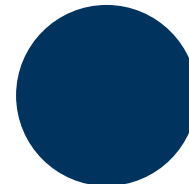

Aruba blue, pearl effect* – Q9

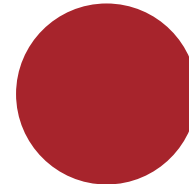

Garnet red, pearl effect – 9C

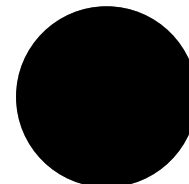

Lava grey, pearl effect* – 1R

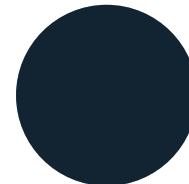

Meteor grey, pearl effect – X5

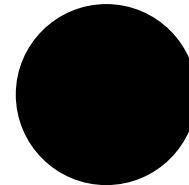

Phantom black, pearl effect – L8

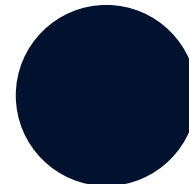

Deep sea blue, pearl effect – 8A

S line colours

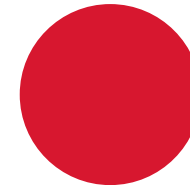

Misano red, pearl effect – N9

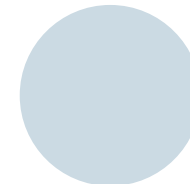

Monza silver, metallic – U7

Optional colours

Basic RRP
£510.64

Total RRP inc VAT
£600.00

S5 Sportback colours

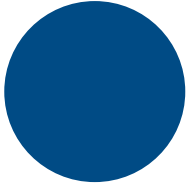

Sprint blue, pearl effect - 5N

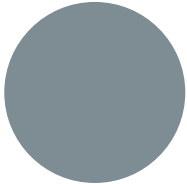

Quartz grey, metallic - Q4

Paint

Audi exclusive

Everyone has a favourite colour. No matter what yours is, Audi exclusive provides a range of unique colours that have been designed to set your car apart. Choose from the swatches here, or specify any other paint colour in the Audi range - whether it's Jet blue from the Audi R8 or Alpine white from the original Audi quattro®. The choice is yours.

Customised

If you have a particular colour in mind, we'll mix the exact metallic or pearl-effect shade you want.**

*Not available on Standard models.

**Custom paint is subject to factory approval, and is available for metallic and pearl-effect water-based paints only. Three-colour process colours and two-tone schemes are not available.

All the colour swatches on this page are matched as accurately as possible to the actual paint colours used. However, due to print processes, Audi UK cannot guarantee that colours shown are 100% accurate.

Visit your local Audi Centre for a more accurate colour swatch.

RRP - Recommended Retail Price.

VAT is calculated at 17.5% but this may alter to reflect any change in the applicable VAT rate.

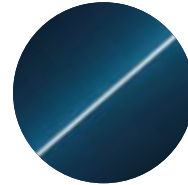

Palace blue, pearl effect

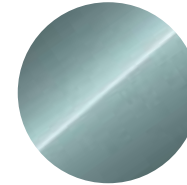

Morning dew, metallic

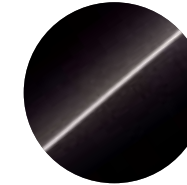

Saddle brown, pearl effect

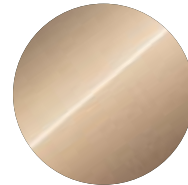

Sand beige, pearl effect

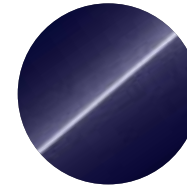

Velvet purple, pearl effect



Any colour in the Audi range

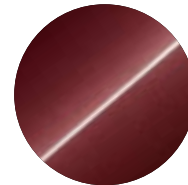

Classic red, pearl effect

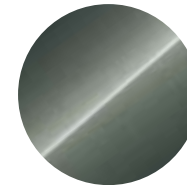

Oak green, metallic



Customised paint

Audi exclusive*

Basic RRP
£1,446.81

Total RRP inc VAT
£1,700.00

Customised**





Basic RRP
£2,042.55

Total RRP inc VAT
£2,400.00

Upholstery

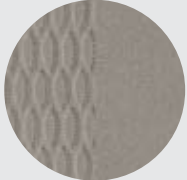
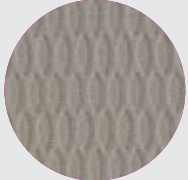
Standard seats

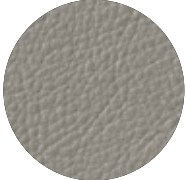
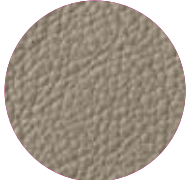
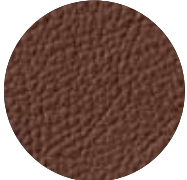
Choose your favourite upholstery from the swatches shown opposite to give your car's interior the look and feel you want.

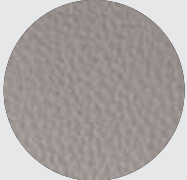
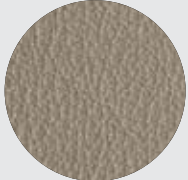
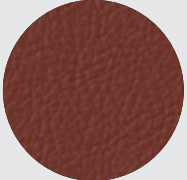
					Standard	SE	S line	S5 quattro	Basic RRP	Total RRP inc VAT
Arcade cloth					S	-	-	-	No charge	No charge
	Black - GD	Light grey - GQ	Cardamom beige* - RH							
Milano leather					-	S	-	-	No charge	No charge
	Black - GD	Light grey - GQ/CX	Cardamom beige - RH/CU	Cinnamon - CN						
Valcona leather					-	•	-	-	£302.13	£355.00
	Black - GD	Light grey - GQ/CX	Cardamom beige - RH/CU	Cinnamon - CN						

Options are subject to availability and may extend delivery.

- = Not available
- = Available
- S = Standard

All leather upholstery choices include seats, head restraints, door inserts and front centre armrest (if fitted) in leather.

*Colour swatches have been matched as accurately as possible. However, they may not represent the true colour.

RRP - Recommended Retail Price.

VAT is calculated at 17.5% but this may alter to reflect any change in the applicable VAT rate.

Upholstery

Sports seats

					Standard	SE	S line	S5 quattro	Basic RRP	Total RRP inc VAT	
Milano leather					-	•	-	-	£404.26	£475.00	
	Black - GD	Light grey - GQ/CX	Cardamom beige - RH/CU	Cinnamon - CN							
	Valcona leather					-	•	-	-	£706.38	£830.00
		Black - GD	Light grey - GQ/CX	Cardamom beige - RH/CU	Cinnamon/Black - CP						
											
	Lunar silver/Black - FY	Cardamom beige/Black - CV									
Leather/Alcantara					-	•	-	-	£404.26	£475.00	
	Black - GD	Light grey - GQ									

Options are subject to availability and may extend delivery.

- = Not available
 • = Available
 S = Standard





All leather upholstery choices include seats, head restraints, door inserts and front centre armrest (if fitted) in leather.

RRP - Recommended Retail Price.

VAT is calculated at 17.5% but this may alter to reflect any change in the applicable VAT rate.

Upholstery

S line seats

		Standard	SE	S line	S5 quattro	Basic RRP	Total RRP inc VAT
Leather/Alcantara		-	-	•	-	No charge	No charge
							
Milano leather		-	-	S	-	No charge	No charge
Valcona leather		-	-	•	-	£302.13	£355.00

Options are subject to availability and may extend delivery.

- = Not available
- = Available
- S = Standard

All leather upholstery choices include seats, head restraints, door inserts and front centre armrest (if fitted) in leather.

*Colour swatches have been matched as accurately as possible. However, they may not represent the true colour.

RRP – Recommended Retail Price.

VAT is calculated at 17.5% but this may alter to reflect any change in the applicable VAT rate.

Upholstery

S5 Super Sports seats

Climate comfort seats

The front climate comfort seats include 4-way electrical lumbar adjustment and manual height adjustment.





Options are subject to availability and may extend delivery.

- = Not available
- = Available
- S = Standard

All leather upholstery choices include seats, head restraints, door inserts and front centre armrest (if fitted) in leather.

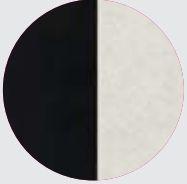
RRP – Recommended Retail Price.

VAT is calculated at 17.5% but this may alter to reflect any change in the applicable VAT rate.

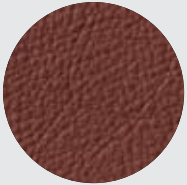
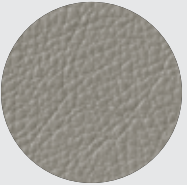
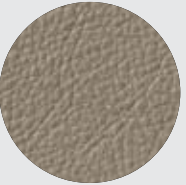
					Standard	SE	S line	S5 quattro	Basic RRP	Total RRP inc VAT
Silk Nappa leather					-	-	-	S	No charge	No charge
	Black, with Silver stitching - ZM/SC	Spectral silver/Black - SP/SQ	Magma red/Black - FA/SJ	Mustang brown/Black - SH/SK						
Milano leather					•	•	-	-	£3,353.19	£3,940.00
	Black - GD	Cinnamon brown - CN	Light grey - GQ	Cardamom beige - CU						

Colour and trim guide

Interior trim colours

Standard

To help you choose the right interior for your new A5 Sportback, please use this guide, showing the carpet, dashboard and headlining colours that have been matched to your chosen upholstery.

Order Code	Upholstery	Carpet	Dashboard (upper/lower)	Headlining	Arcade cloth (NOB)	Milano leather (N5W)	Valcona leather (N5D)
GD	Black	Black	Black/Black	Silver	●	●	●
CN	Cinnamon	Black	Black/Black	Silver	-	●	●
GQ	Light grey	Quartz grey	Graphite grey	Silver	●	●	●
CX	Light grey	Black	Black	Silver	-	●	●
RH	Cardamom beige	Coriander beige	Taupe beige/Tan beige	Linen beige	●	●	●
CU	Cardamom beige	Black	Black	Linen beige	-	●	●

Sports seats

Order Code	Upholstery	Carpet	Dashboard (upper/lower)	Headlining	Leather/Alcantara (N7U)	Milano leather (N5W)	Valcona leather (N5D)
GD	Black	Black	Black/Black	Silver	●	●	●
GQ	Light grey	Quartz grey	Graphite grey	Silver	●	●	●
RH	Cardamom beige	Coriander beige	Taupe beige/Tan beige	Linen beige	-	●	●
CN	Cinnamon	Black	Black/Black	Black	-	●	-
CP	Cinnamon/Black	Black	Black/Black	Silver	-	-	●
CU	Cardamom beige	Black	Black	Linen beige	-	●	-
CV	Cardamom beige/Black	Black	Black	Linen beige	-	-	●
CX	Light grey	Black	Black	Silver	-	●	-
FY	Lunar silver/Black	Black	Black	Silver	-	-	●

Options are subject to availability and may extend delivery.

- = Not available
● = Available
S = Standard

Colour and trim guide

Interior trim colours

S line Sports seats

Order Code	Upholstery	Carpet	Dashboard (upper/lower)	Headlining	Leather/Alcantara (N7K)	Milano leather (N1Y)	Valcona leather (N1V)
QE	Black (with black stitching)	Black	Black/Black	Black	●	●	●
QF	Black (with silver stitching)	Black	Black/Black	Black	●	-	-

S5 Super Sports seats

Order Code	Upholstery	Carpet	Dashboard	Headlining	Silk Nappa leather (N1U)
ZM or SC	Black	Black	Black	Black/Silver	●
SP or SQ	Spectral Silver/Black	Black	Black	Black/Silver	●
FA or SJ	Magma red/Black	Black	Black	Black/Silver	●
SH or SK	Mustang Brown/Black	Black	Black	Black/Silver	●

Options are subject to availability and may extend delivery.

- = Not available
 ● = Available
 S = Standard

Upholstery

Audi exclusive

With Audi exclusive, you can specify your seats in Valcona leather or leather/Alcantara, in an array of different colours shown to the right.

Select just one all-over shade for each seat, or customise each panel in two or more complementary colours from the distinctive Audi exclusive palette. You can even choose the colour of the decorative stitching – to match or contrast with your chosen upholstery – from this varied collection. Whatever combination you decide upon, we think you'll be extremely comfortable with the result.

Options are subject to availability and may extend delivery.

– = Not available
• = Available
S = Standard

RRP – Recommended Retail Price.

*Only in combination with Sports seats.

VAT is calculated at 17.5% but this may alter to reflect any change in the applicable VAT rate.

Order Code		Standard	SE	S line	S5 quattro®	Basic RRP	Total RRP inc VAT
PYB/S3G	Audi exclusive leather package 1 in Valcona leather – Includes leather-covered seat upholstery, door trim inserts and front centre armrest; all are colour-coordinated with the option of contrasting stitching on seat side sections and head restraints. Leather can be specified in a variety of colours from the Audi exclusive range	–	•	•	–	£2,085.10	£2,450.00
PYC/S3G	Audi exclusive leather package 1 in Valcona leather/Alcantara – Includes leather-covered front and back seat side trims, head restraints, front centre armrest and alcantara-covered-door trim inserts and seat centre sections; all are colour-coordinated with the option of contrasting stitching on seat side sections and head restraints*	–	•	–	–	£2,493.62	£2,930.00
		–	–	•	–	£2,085.10	£2,450.00
PYE/S3G	Audi exclusive leather package 2 in Valcona leather – Includes all the contents of leather package 1 plus: leather-covered seat backrest covers, rear centre armrest and door armrests and handles.	–	•	•	–	£3,174.47	£3,730.00

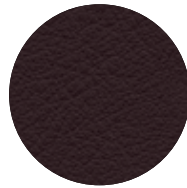

Chestnut brown

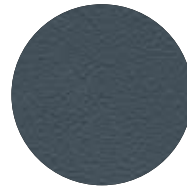

Jet grey

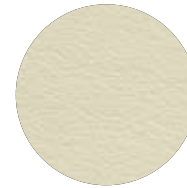

Alabaster white

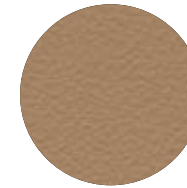

Sand beige

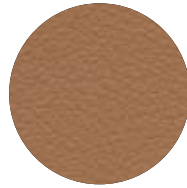

Cocos

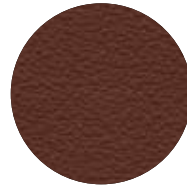

Saddle brown

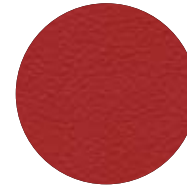

Crimson red

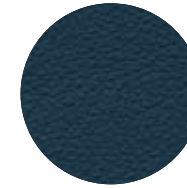

Palace blue

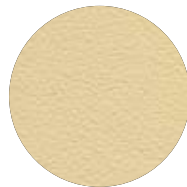

Magnolia



Havanna brown

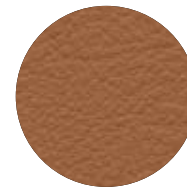

Cognac

Also available:

Alcantara colours: available in all of the above Audi exclusive colours, except for Crimson red, Jet grey and Sand beige. Alcantara equivalents are Chilli red, Amethyst grey, and Sesame beige respectively.

Carpet colours: available in all of the above Audi exclusive colours, except for Crimson red and Saddle brown.

Upholstery

Audi exclusive line

Audi exclusive is ultimately about choice – but if you'd rather leave some of the decisions in the capable hands of our designers, the expert team at quattro® GmbH have compiled Audi exclusive line, combining some of the most popular elements of the exclusive range in one, beautifully coordinated package.

Options are subject to availability and may extend delivery.

– = Not available
• = Available
S = Standard

RRP – Recommended Retail Price.

VAT is calculated at 17.5% but this may alter to reflect any change in the applicable VAT rate.

Order Code		Standard	SE	S line	S5 quattro®	Basic RRP	Total RRP inc VAT
WQK	Audi exclusive line	–	•	–	–	£1,914.89	£2,250.00



Magnolia – QQ



Cognac – QX



Alabaster white – UA

This package includes

- ▶ Two-tone Valcona leather upholstery. Seat centres in Magnolia, Cognac or Alabaster white. Seat-side sections and head restraints in black with decorative stitching to match seat centres
- ▶ Door panels in Valcona leather to match seat centres
- ▶ 3-spoke Sports multi-function steering wheel in black leather and gear lever gaiter with stitching to match seat centres
- ▶ Black front and rear floor mats with leather piping to match seat centres
- ▶ Matt-brushed aluminium inlays
- ▶ Audi exclusive scuff plates
- ▶ Black cloth headlining
- ▶ Black dashboard and carpets

Inlays

Inlays are the all-important finishing touch that add flair and interest to your car's interior.

Order Code		Standard	SE	S line	S5 quattro	Basic RRP	Total RRP inc VAT
5MA	Micrometallic platinum	S	S	-	-	No charge	No charge
5TG	Matt-brushed aluminium	-	-	S	S	No charge	No charge
5TE	Aluminium hologram	•	•	-	-	£127.66	£150.00
5TK	Fine grain ash, Almond beige	•	•	-	-	£276.60	£325.00
5MG	Walnut brown	•	•	-	-	£276.60	£325.00
7TD	Laurel nutmeg	•	•	-	-	£276.60	£325.00
5TL	Piano finish, black	-	-	•	-	No charge	No charge
5TZ	Fine grain birch wood, grey	-	-	•	•	£148.98	£175.00

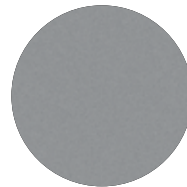

Micrometallic platinum – **5MA**

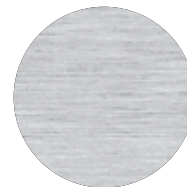

Matt-brushed aluminium – **5TG**

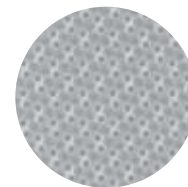

Aluminium hologram – **5TE**



Fine grain ash, Almond beige – **5TK**



Walnut brown – **5MG**



Laurel nutmeg – **7TD**

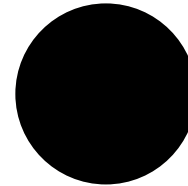

Piano finish, black – **5TL**



Fine grain birch wood, grey – **5TZ**

Options are subject to availability and may extend delivery.

- = Not available
• = Available
S = Standard

RRP – Recommended Retail Price.

VAT is calculated at 17.5% but this may alter to reflect any change in the applicable VAT rate.

Inlays

Audi exclusive

Audi exclusive has sourced a wide range of materials which you can select for your inlays, from Sepia oak to rich quilted Maple wood.

Order Code		Standard	SE	S line	S5 quattro®	Basic RRP	Total RRP inc VAT
YTA/S3G	Inlays (cannot be combined with the wood inlays shown on page 36)	-	•	•	•	£680.85	£800.00



Fine grain maple, copper



Fine grain ash, nougat



Fine grain myrtle, nutmeg



Poplar, saffron



Oak, sepia



Quilted maple, gold

Options are subject to availability and may extend delivery.

- = Not available
• = Available
S = Standard

RRP – Recommended Retail Price.

VAT is calculated at 17.5% but this may alter to reflect any change in the applicable VAT rate.

Wheels, tyres and suspension

Choose a set of specially-selected alloy wheels to subtly enhance the way your car looks and drives. And you can also specify Audi drive select, which allows you to change suspension and steering settings according to your driving style.



19" x 8.5J '5-spoke Y' design
alloy wheels – PRV



19" x 9J '5-segment-spoke' design
alloy wheels – PQ6



19" x 9J '20-spoke' design
alloy wheels – PQS



18" x 8.5J '10-spoke V' design
alloy wheels – PRC



18" x 8.5J '5-arm dynamic' design
alloy wheels – PRL



20" x 9J '7-arm double-spoke' design
alloy wheels – PQF

Options are subject to availability
and may extend delivery.

– = Not available
• = Available
S = Standard

RRP – Recommended Retail Price.

VAT is calculated at 17.5% but this may alter to
reflect any change in the applicable VAT rate.

Wheels, tyres and suspension

Order Code		Standard	SE	S line	S5 quattro	Basic RRP	Total RRP inc VAT
PRS	17" x 8J '6-arm' design alloy wheels with 225/50 R17 Y tyres	S	-	-	-	No charge	No charge
CH5	17" x 7.5J '7-arm' design alloy wheels with 225/50 R17 tyres	●	S	-	-	£165.96	£195.00
PRL	18" x 8.5J '5-arm dynamic' design alloy wheels with 245/40 R18 tyres	-	●	-	-	£514.89	£605.00
PQR	18" x 8.5J '5-spoke' design alloy wheels with 245/40 R18 Y tyres	-	-	S	-	No charge	No charge
PQ5	18" x 8.5J '10-spoke' design alloy wheels with 245/40 R18 tyres	-	-	●	-	No charge	No charge
PRC	18 x 8.5J '10-spoke V' design alloy wheels with 245/40 R18 Y tyres	-	●	-	-	£553.19	£650.00
PRV	19" x 8.5J '5-spoke Y' design alloy wheels with 255/35 R19 Y tyres	-	●	-	-	£1,106.38	£1,300.00
PQS	19" x 9J '20-spoke' design, 2-piece alloy wheels with 255/35 R19 Y tyres	-	●	-	-	£1,191.49	£1,400.00
		-	-	●	-	£382.98	£450.00
PQ6	19" x 9J '5-segment-spoke' design alloy wheels with 255/35 R19 tyres	-	●	-	-	£1,191.49	£1,400.00
		-	-	●	-	£382.98	£450.00
PQF	20"x9J '7-arm double-spoke' design alloy wheels with 255/30 R20 tyres	-	-	●	-	£1,059.57	£1,245.00
		-	-	-	●	£936.17	£1,100.00
2H1	Audi drive select – (must be combined with dynamic steering and/or damper control and/or quattro® Sports differential)	-	●	●	●	£182.98	£215.00
1N7	Dynamic steering – (must be combined with Audi drive select)	-	●	●	●	£604.26	£710.00
1BL	Damper control – (must be combined with Audi drive select)	-	●	-	-	£565.96	£665.00
		-	-	●	●	£251.06	£295.00
GH2	Audi quattro® Sports differential (must be combined with Audi drive select, only on 3.0 TDI and 3.2 FSI quattro® engines)	-	●	●	●	£514.89	£605.00
1BV	S line Sports suspension, with stiffer springs, stiffer shock absorbers and a lower ride height	-	-	●	-	No charge	No charge
1N3	Servotronic power steering (standard on 190PS and above models)	●	●	●	S	£153.19	£180.00
1BE	Sports suspension, with stiffer springs and shock absorbers	●	●	S	-	£212.77	£250.00

Options are subject to availability and may extend delivery.

- = Not available
● = Available
S = Standard

RRP – Recommended Retail Price.

VAT is calculated at 17.5% but this may alter to reflect any change in the applicable VAT rate.

Audio and communication

Stay in touch using our range of communication functions, and give each journey its own soundtrack with our advanced audio equipment.

Options are subject to availability and may extend delivery.

- = Not available
 • = Available
 S = Standard

RRP – Recommended Retail Price.

VAT is calculated at 17.5% but this may alter to reflect any change in the applicable VAT rate.

Order Code		Standard	SE	S line	S5 quattro	Basic RRP	Total RRP inc VAT
UF7	Audi Music Interface. Universal connection for use with stereo audio sources and iPod generation 4 onwards (iPod, iPod mini, iPod nano, iPod photo, iPod video). Provides intuitive control through the audio system and multi-function steering wheel. It also replicates the iPod display on the audio screen, including track titles. The interface provides power as well as a convenient rubberised storage tray. An adaptor cable is required at additional cost. Please consult your Audi Centre for details (includes 2 cables to connect your iPod or USB MP3 device)	-	•	•	•	£212.77	£250.00
8UM	Audi Symphony radio, with front-loading MP3-compatible 6-CD changer, 6.5" colour screen, SD memory card reader and AUX-IN socket in centre console (must be combined with Audi sound system). Not in conjunction with Satellite Navigation	•	•	•	•	£234.04	£275.00
9VK	Bang & Olufsen sound system, designed specifically for the A5 Sportback, providing surround sound reproduction with dynamic noise compensation, 14 high-performance loudspeakers (505 Watt) and 10-channel amplifier	-	•	•	•	£446.81	£525.00
7A6	CD changer (only in combination with Satellite Navigation – DVD-based)	-	•	•	•	£255.32	£300.00
7D1	CD changer (only in combination with technology package)	-	•	•	•	£255.32	£300.00
QV3	DAB digital radio	-	•	•	•	£255.32	£300.00
PNW	Satellite Navigation system – DVD-based (CD changer is recommended with this option)	-	•	•	•	£1,348.94	£1,585.00



Symphony radio



Bang & Olufsen surround sound system

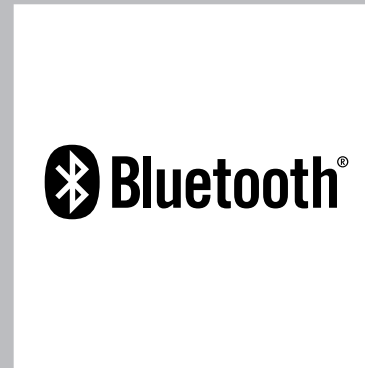

Mobile telephone preparation – Bluetooth interface

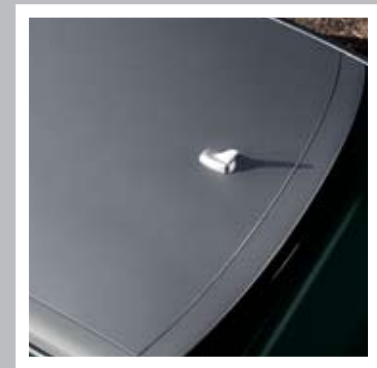

Mobile telephone preparation – Low

Audio and communication

Order Code		Standard	SE	S line	S5 quattro	Basic RRP	Total RRP inc VAT
9ZX	Mobile telephone preparation – Bluetooth interface	●	●	●	●	£217.02	£255.00
9ZW	Mobile telephone preparation – High. Uses Bluetooth interface with no physical connection to your A5 Sportback, including roof aerial for optimal reception. Please note that your mobile phone must have SIM-Access Profile facility for full functionality (only in combination with technology package or Satellite Navigation – DVD-based)	-	●	●	●	£553.19	£650.00
PT4	Mobile telephone preparation – High (with privacy handset). The handset allows passengers to make private calls, providing remote control of the telephone functions as well as a convenient SMS text messaging function. The handset is charged from a docking station integrated in the front centre armrest (only in combination with technology package or Satellite Navigation – DVD-based)	-	●	●	●	£808.51	£950.00
PT5	Mobile telephone preparation – Low. Includes front centre armrest. Uses Bluetooth interface or cradle to connect to your A5 Sportback, including roof aerial for optimal reception and charger. A phone adaptor is required at extra cost – please consult your Audi Centre for phone compatibility. (Must be combined with Concert radio or Symphony radio and multi-function steering wheel)	●	-	-	-	£446.81	£525.00
9ZF		-	●	●	●	£319.15	£375.00
PNG 8T1 UF7	Technology package – High. Satellite Navigation – HDD-based with MMI 3G – High, Audi Music Interface and cruise control	-	●	●	●	£1,663.83	£1,955.00
PNG 8T4 UF7	Technology package – High. Satellite Navigation – HDD-based with MMI 3G – High, Audi Music Interface and adaptive cruise control	-	●	●	●	£2,472.34	£2,905.00
QV9	TV reception – analogue and digital – only in combination with technology package	-	●	●	●	£723.40	£850.00

Options are subject to availability and may extend delivery.

- = Not available
● = Available
S = Standard

RRP – Recommended Retail Price.

VAT is calculated at 17.5% but this is subject to change to reflect any change in the applicable VAT rate.



MMI 3G – High, part of HDD Satellite Navigation



MMI 3G control – High, part of HDD Satellite Navigation



CD changer

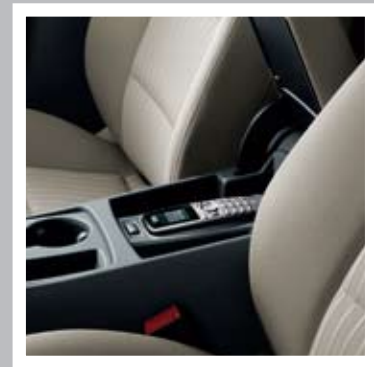

Mobile telephone preparation – High (with privacy handset)

Steering wheels

You can choose from a selection of advanced leather multi-function steering wheels, allowing you to control your audio system at the touch of a button.

Order Code		Standard	SE	S line	S5 quattro	Basic RRP	Total RRP inc VAT
1XW	Steering wheel – leather 3-spoke multi-function	●	S	-	-	£212.77	£250.00
1XX	Steering wheel – leather 3-spoke multi-function with paddle shift for auto transmission	●	S	-	-	£327.66	£385.00
2ZQ	Steering wheel – leather 4-spoke multi-function (only in combination with Audi lane assist)	-	●	●	-	No charge	No charge
2ZS	Steering wheel – leather 4-spoke multi-function with paddle shift for auto transmission (only in combination with Audi lane assist)	-	●	●	-	No charge	No charge
YRH/ S3G	Audi exclusive steering wheel*	-	●	●	●	£344.68	£405.00

Options are subject to availability and may extend delivery.

- = Not available
● = Available
S = Standard

RRP – Recommended Retail Price.

*Available in any of the 11 exclusive colours shown on page 34

VAT is calculated at 17.5% but this may alter to reflect any change in the applicable VAT rate.





Safety and security

Intelligent technology designed to give you better all-round awareness and safety on the road.

Options are subject to availability and may extend delivery.

- = Not available
- = Available
- S = Standard

*HomeLink® is a registered trademark of Johnson Controls. For information on compatibility, visit www.homelink.com.

RRP – Recommended Retail Price.

VAT is calculated at 17.5% but this may alter to reflect any change in the applicable VAT rate.

Order Code		Standard	SE	S line	S5 quattro	Basic RRP	Total RRP inc VAT
7X1	Acoustic parking system (rear only)	•	S	S	S	£302.13	£355.00
7X4	Audi parking system plus , aids parking by acoustically and graphically indicating distances to obstacles in front of and behind your A5 Sportback	-	•	•	•	£255.32	£300.00
7X8	Audi parking system advanced , aids parking by acoustically and visually indicating distances to obstacles in front of and behind your A5 Sportback with guiding lines. Measured by ultrasonic sensors and camera integrated discreetly in the boot handle. (Only in combination with technology package or Satellite Navigation – DVD-based)	-	•	•	•	£553.19	£650.00
UH2	Audi hill-hold assist , automatically activates electromechanical parking brake when stationary (cannot be combined with Start-Stop technology)	•	•	•	•	£38.30	£45.00
7Y1	Audi side assist , aids the driver when changing lane. Audi side assist monitors the area behind your A5 Sportback using radar sensors located discreetly in the rear bumper, informing the driver via a visual warning signal in the door mirror if there is a vehicle in their blind spot or approaching quickly from behind. The system is activated via a button in the driver's door	-	•	•	•	£382.98	£450.00
7Y2	Audi lane assist , uses a discreet camera at the top of the windscreen to monitor the road ahead. The driver is warned via a vibration of the steering wheel if the vehicle is about to exit the lane unintentionally (only in combination with the 4-spoke leather multi-function steering wheel)	-	•	•	-	£382.98	£450.00

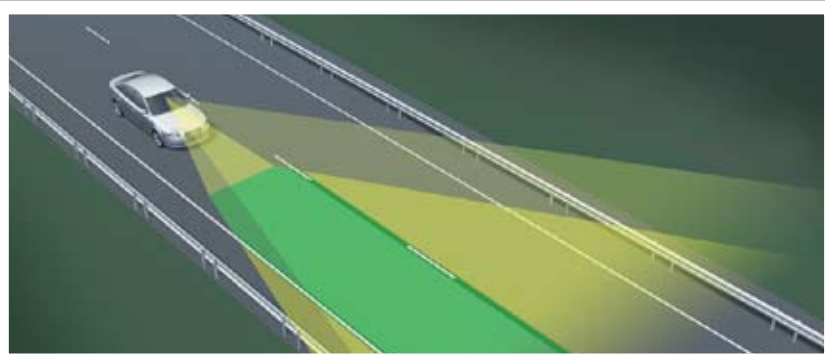

Audi lane assist



Acoustic parking system (rear only)

Safety and security

Order Code			Standard	SE	S line	S5 quattro	Basic RRP	Total RRP inc VAT
6XE	Door mirrors – heated and electrically folding		-	●	●	●	£148.94	£175.00
6XK	Door mirrors – electrically folding and auto-dimming. Includes auto-dimming rear-view mirror and light and rain sensors which control the automatic headlights facility, the coming home/leaving home function and the automatic windscreen wipers	4-cylinder models	-	●	●	-	£489.36	£575.00
4L6 8N6		6-cylinder models	-	●	●	●	£404.26	£475.00
VC1	Garage door opener (HomeLink),* programmable radio-operated remote control for compatible doors/gates and control buttons integrated in the roof module at the front		●	●	●	●	£148.94	£175.00
7K6	Tyre pressure monitor		●	●	●	●	£63.83	£75.00
4X4	Rear side airbags		●	●	●	●	£212.77	£250.00

Options are subject to availability and may extend delivery.

- = Not available
- = Available
- S = Standard

*HomeLink® is a registered trademark of Johnson Controls. For information on compatibility, visit www.homelink.com.

RRP – Recommended Retail Price.

VAT is calculated at 17.5% but this may alter to reflect any change in the applicable VAT rate.



Door mirrors – electrically folding



Audi parking system advanced

Interior equipment

Make sure your car's interior feels exactly the way you want by customising it using the comprehensive list of options.

Options are subject to availability and may extend delivery.

- = Not available
 • = Available
 S = Standard

RRP – Recommended Retail Price.

VAT is calculated at 17.5% but this may alter to reflect any change in the applicable VAT rate.

Order Code		Standard	SE	S line	S5 quattro	Basic RRP	Total RRP inc VAT
9AQ	3-zone climate control (standard on 6-cylinder models, must be combined with 8N6 or 8N7)	-	•	•	S	£382.98	£450.00
8T4	Adaptive cruise control (ACC) . Automatic distance regulation, using radar sensors to maintain required distance by braking and accelerating. Four programs (distance 1 to distance 4) set via steering column controls of the cruise control system	-	•	•	•	£936.17	£1,100.00
4F2	Advanced key . Access and authorisation system which automatically exchanges data between key and vehicle, allowing the driver to keep the key in their pocket or bag at all times. To unlock and open, simply lift the exterior door handle. To lock, press the button on the handle. Pressing the Start/Stop button integrated in the centre console starts and stops the engine	-	•	•	•	£421.28	£495.00
YRB/S3G	Audi exclusive controls pack – includes leather-covered steering wheel and gear-shift gaiter*	-	•	•	•	£591.49	£695.00
4L6	Auto-dimming rear-view mirror , including light and rain sensors which control the automatic headlights facility, the coming home/leaving home function and the automatic windscreen wipers	-	•	•	•	£255.32	£300.00
8N6		-	•	•	•	£170.21	£200.00
6NQ	Black headlining , only in combination with GD and GG interiors on A5 Sportback	•	•	S	S	£170.21	£200.00
8T1	Cruise control . For holding any speed above 25mph	•	•	•	•	£161.70	£190.00
8N6	Light and rain sensor (standard on 6-cylinder models)	-	•	•	S	£85.11	£100.00



3-zone climate control



Advanced key (engine Start/Stop button)

Interior equipment

Order Code		Standard	SE	S line	S5 quattro	Basic RRP	Total RRP inc VAT
QQ1	Interior light package. Includes reading lights at rear, illuminated vents, internal door controls and vanity mirrors, active door reflectors, entrance lighting, footwell lighting at front and illuminated glove compartment	●	●	●	S	£85.11	£100.00
7HB	Leather armrests includes leather-covered armrest on door panels for front and rear (only in combination with leather upholstery)	-	●	●	●	£170.21	£200.00
PKH QE1	Storage pack. Includes storage nets on the back of the front seats, storage compartment under the front seats (only under passenger seat if memory function is fitted), drinks holder in the rear centre armrest and lockable glove compartment. Also includes tie-down straps and 12V socket in the boot	●	●	●	●	£148.94	£175.00
6SJ	Reversible load mat with bumper cover – one side in rubber, the other in carpet	●	●	●	●	£72.34	£85.00
6Q6	Audi exclusive aluminum gear knob – manual gearboxes only	●	●	●	-	£93.62	£110.00
YSQ/ S3G	Audi exclusive carpets – includes four Audi exclusive floor mats with leather piping, (cannot be combined with option YSR/S3G – Audi exclusive carpets)*	-	●	●	●	£740.43	£870.00
YSR/ S3G	Audi exclusive floor mats with leather piping (cannot be combined with option YSQ – Audi exclusive carpets)*	-	●	●	●	£378.72	£445.00

Options are subject to availability and may extend delivery.

- = Not available
● = Available
S = Standard

RRP – Recommended Retail Price.

*The colours of the carpet and floor mats with leather piping can be selected from any of the 11 exclusive colours shown on page 34

VAT is calculated at 17.5% but this may alter to reflect any change in the applicable VAT rate.



Auto-dimming rear-view mirror



Cruise control

Seats

Choose from a variety of different seat options so you can maintain the right driving posture at all times.

Order Code		Standard	SE	S line	S5 quattro	Basic RRP	Total RRP inc VAT	
PV3	Convenience pack , comprising electric front seats with memory function on driver's side, door mirrors – electrically folding and auto-dimming with memory function, auto-dimming rear-view mirror and light and rain sensors which control the automatic headlights facility, the coming home/leaving home function and the automatic windscreen wipers	4-cylinder models	-	●	-	-	£1,276.60	£1,500.00
6XL		6-cylinder models	-	●	-	-	£1,191.49	£1,400.00
4L6		4-cylinder models	-	-	●	●	£1,017.02	£1,195.00
8N6		6-cylinder models	-	-	●	●	£931.91	£1,095.00
PV1	Electric front seats , with adjustment for height, forwards and backwards position, backrest angle and lumbar support for driver and front passenger seats		-	●	-	-	£638.30	£750.00
			-	-	●	S	£378.72	£445.00
4A3	Heated front seats . Individually controlled variable temperature adjustment		●	●	●	●	£212.77	£250.00
4A4	Heated front and outer rear seats . Individually controlled variable temperature adjustment		●	●	●	●	£382.98	£450.00
3X2	Through-load facility , with removable ski bag for transporting long objects		●	●	●	S	£136.17	£160.00

Options are subject to availability and may extend delivery.

- = Not available
● = Available
S = Standard

RRP – Recommended Retail Price.

VAT is calculated at 17.5% but this may alter to reflect any change in the applicable VAT rate.



Heated front and outer rear seats

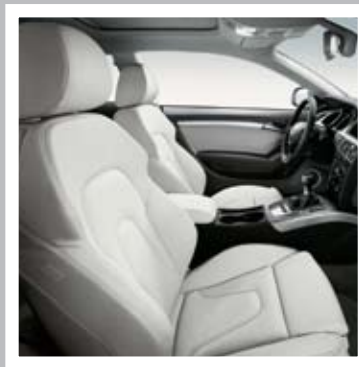

Heated front seats



Electric front seats

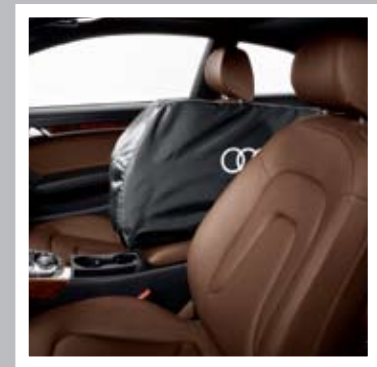

Through-load facility

Exterior equipment

Make sure your car looks exactly as you want it to by selecting some of our striking options.

Order Code		Standard	SE	S line	S5 quattro	Basic RRP	Total RRP inc VAT
8Q5	Adaptive light , swivelling headlights for improved illumination of a winding road	-	-	●	●	£276.60	£325.00
PX1 8Q5	Adaptive Xenon Plus headlights with LED daytime-running lights (includes headlight washers)	●	●	-	-	£940.43	£1,105.00
2Z7	Deletion of engine capacity designation at rear	●	●	●	●	No charge	No charge
2Z0	Deletion of model and engine capacity designation at rear	●	●	●	●	No charge	No charge
3FE	Electric slide-and-tilt sunroof	●	●	●	●	£723.40	£850.00
8N7	High-beam assistant (must be combined with auto-dimming rear-view mirror)	-	●	●	●	£93.62	£110.00
1D2	Tow bar , factory-fitted and removable	●	●	●	●	£553.19	£650.00

Warranty extensions

EA6	1-year Warranty Extension. Audi Warranty Extension, prolonging your 3-year/60,000-mile Audi warranty to 4 years or 75,000 miles (whichever comes sooner). Comprehensive cover equivalent to the Audi warranty, protecting you against unexpected repairs. Only available as a new car option. Transferable between owners	●	●	●	●	£446.81	£525.00
EA9	2-year Warranty Extension. Audi Warranty Extension, prolonging your 3-year/60,000-mile Audi warranty to 5 years or 90,000 miles (whichever comes sooner). Comprehensive cover equivalent to the Audi warranty, protecting you against unexpected repairs. Only available as a new car option. Transferable between owners	●	●	●	●	£1,046.81	£1,230.00

Options are subject to availability and may extend delivery.

- = Not available
- = Available
- S = Standard

RRP – Recommended Retail Price.

VAT is calculated at 17.5% but this may alter to reflect any change in the applicable VAT rate.

Merchandise

From the enthusiasts' motorsport collection to the sophisticated Audi collection, there's a wide variety of adults' and children's clothing, lifestyle accessories and collectables, all of which bear the Audi name.

Please speak to a member of our team at your local Audi Centre to see the full Audi collection and to place an order. A selection of Audi merchandise is also available to buy from audi.co.uk/merchandise.



Audi kids



Bags and leather goods



Clothing



Motorsport



Sport and travel



Model cars

Accessories

Choosing an Audi isn't just a matter of deciding on the model you want; it's about creating a car that suits your needs perfectly. And that's why we've developed a whole range of accessories to enhance your A5 Sportback, enabling you to customise it down to the last detail. Like your Audi, all these accessories are developed to the highest possible standards. And they're all available exclusively from Audi.

To find out more, just visit audi.co.uk/accessories or contact your local Audi Centre.

Warranty

All of the accessories available on the A5 Sportback are covered by a three-year warranty* if they are ordered and included in the purchase price of the car at date of delivery. Any accessories ordered and installed after delivery include a two-year warranty.*



Sport and design



Transport and touring

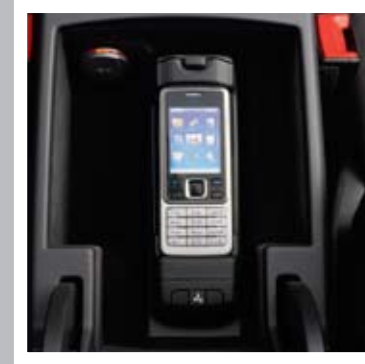

Entertainment and communication



Comfort and protection

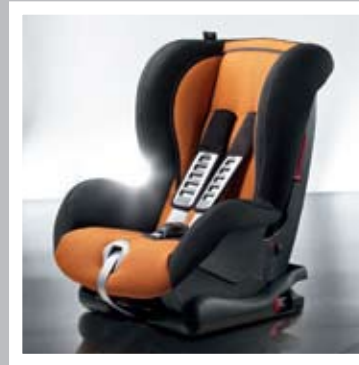

Family



Safety and security

*Excluding Road Angel products.
Audi Accessories warranty terms and conditions can be found at audi.co.uk

A5 Sportback technical data

Engine	2.0 TFSI	2.0 TFSI	2.0 TFSI	2.0 TFSI quattro®	3.2 FSI quattro®	2.0 TDI	2.0 TDI quattro®	2.7 TDI	3.0 TDI quattro®	3.0 TDI quattro®
Transmission	6-speed manual	multitronic	6-speed manual	7-speed S tronic	7-speed S tronic	6-speed manual	6-speed manual	multitronic	6-speed manual	7-speed S tronic
Cylinder	4-cylinder	4-cylinder	4-cylinder	4-cylinder	V6	4-cylinder	4-cylinder	V6	V6	V6
Displacement, cubic cm (valves per cylinder)	1984	1984	1984	1984	3197	1968	1968	2698	2967	2967
Max. power ¹ , PS at rpm	180	180	211	211	265	170	170	190	240	240
Max. torque, Nm at rpm	320/1500-3900	320/1500-3900	350/1500-4200	350/1500-4200	330/3000-5000	350/1750-2500	350/1750-2500	400/1400-3250	500/1500-3000	500/1500-3000
0-62mph acceleration, seconds	8.1	8.6	7.1	6.6	6.6	8.7	8.6	7.9	6.3	6.1
Top speed ² , mph	145	138	152	150	155	142	138	139	155	155
CO ₂ emissions ³ , g/km	152	169	152	172	216	137	152	169	176	174
Benefit in kind (BIK)%	18%	21%	18%	22%	31%	18%	21%	24%	26%	25%
Fuel consumption, mpg (l/100km) Urban	33.6 (8.4)	29.7 (9.5)	33.6 (8.4)	30.4 (9.3)	20.9 (13.5)	43.5 (6.5)	38.7 (7.3)	35.3 (8.0)	31.7 (8.9)	34.0 (8.3)
Fuel consumption, mpg (l/100km) Extra Urban	52.3 (5.4)	48.7 (5.8)	52.3 (5.4)	44.8 (6.3)	41.5 (6.8)	62.8 (4.5)	56.5 (5.0)	50.4 (5.6)	52.3 (5.4)	49.6 (5.7)
Fuel consumption, mpg (l/100km) Combined	43.5 (6.5)	39.2 (7.2)	43.5 (6.5)	38.2 (7.4)	30.4 (9.3)	54.3 (5.2)	48.7 (5.8)	43.5 (6.5)	42.2 (6.7)	42.8 (6.6)
ABI insurance group 1-20/1-50*	15/27 E	15/27 E	16/30 E	16/32 E	16/34 E	14/26 E	14/26 E	15/28 E	17/34 E	17/34 E
Unladen weight ⁴ , kg	1500	1525	1505	1615	1650	1560	1600	1640	1685	1720
Gross weight limit, kg	2030	2055	2035	2145	2180	2060	2130	2170	2215	2250
Roof load/Nose weight, kg	90/80	90/80	90/80	90/80	90/80	90/80	90/80	90/80	90/80	90/80
Max trailer load unbraked ⁴ , kg	750	750	750	750	750	750	750	750	750	750
Max trailer load with 12% gradient ⁴ , kg	1500	1500	1500	1700	1900	1600	1500	1700	1900	1900
Max trailer load with 8% gradient ⁴ , kg	1700	1700	1700	1900	2100	1800	1700	1900	2100	2100
Luggage compartment capacity, rear seats upright, litres	480	480	480	480	480	480	480	480	480	480
Luggage compartment capacity, rear seats folded, litres	980	980	980	980	980	980	980	980	980	980
Fuel tank capacity approx, litres	65	65	65	64	64	64	64	65	64	64

*Highest insurance group rating shown. Group may be lower dependent on trim level. Please visit www.thatcham.org/abigroupratings for details.

¹The given value was obtained in accordance with the specified measurement procedure (the respective current version of the Directive 80/1269/EEC).

²Regulated.

³The given values were calculated in accordance with the specified measurement procedure (the respective current version of Directive 80/1268/EEC). This information does not relate to a single vehicle and does not comprise part of the offer is but merely intended for the purpose of between comparison the different vehicle types.

⁴Vehicle's unladen weight without driver (calculated in accordance with the current version of Directive 80/1268/EEC). The fitting of additional equipment may increase the vehicle's unladen weight and drag coefficient, whereupon the potential carrying capacity and top speed will be correspondingly reduced.

Please note: The maximum power output figures are quoted in PS (or Pferdestärke, which is the metric equivalent of brake horsepower). To convert to brake horsepower, divide the PS figure by 1.0139.

S5 Sportback technical data

Engine	3.0 TFSI
Transmission	S tronic
Cylinder	V6
Displacement, cubic cm (valves per cylinder)	2995
Max. power ¹ , PS at rpm	333
Max. torque, Nm at rpm	440/2900-5300
0-62mph acceleration, seconds	5.4
Top speed ³ , mph	155**
CO ₂ emissions ² , g/km	219
Benefit in kind (BIK)%	31%
Fuel consumption, mpg (l/100km) Urban	20.9 (13.5)
Fuel consumption, mpg (l/100km) Extra Urban	40.4 (7.0)
Fuel consumption, mpg (l/100km) Combined	30.1 (9.4)
ABI insurance group 1-20/1-50*	tbc
Unladen weight, ⁴ kg	1755
Gross weight limit, kg	2285
Roof load/Nose weight, kg	90/80
Max trailer load unbraked, ⁴ kg	750
Max trailer load with 12% gradient, ⁴ kg	1900
Max trailer load with 8% gradient, ⁴ kg	2001
Luggage compartment capacity, rear seats upright, litres	480
Luggage compartment capacity, rear seats folded, litres	980
Fuel tank capacity approx, litres	64

*Highest insurance group rating shown. Group may be lower dependent on trim level. Please visit www.thatcham.org/abigroupratings for details.

**Limited

¹The given value was obtained in accordance with the specified measurement procedure (the respective current version of the Directive 80/1269/EEC).

²Regulated.

³The given values were calculated in accordance with the specified measurement procedure (the respective current version of Directive 80/1268/EEC). This information does not relate to a single vehicle and does not comprise part of the offer is but merely intended for the purpose of between comparison the different vehicle types.

⁴Vehicle's unladen weight without driver (calculated in accordance with the current version of Directive 80/1268/EEC). The fitting of additional equipment may increase the vehicle's unladen weight and drag coefficient, whereupon the potential carrying capacity and top speed will be correspondingly reduced.

*Highest insurance group rating shown. Group may be lower dependent on trim level. Please visit www.thatcham.org/abigrouprating

Please note: The maximum power output figures are quoted in PS (or Pferdestärke, which is the metric equivalent of brake horsepower). To convert to brake horsepower, divide the PS figure by 1.0139.



A5 Sportback dimensions

The technical drawings opposite show the exact dimensions of the A5 Sportback, so you can check everything – from whether the car will fit in your garage to whether your luggage will fit in the boot.

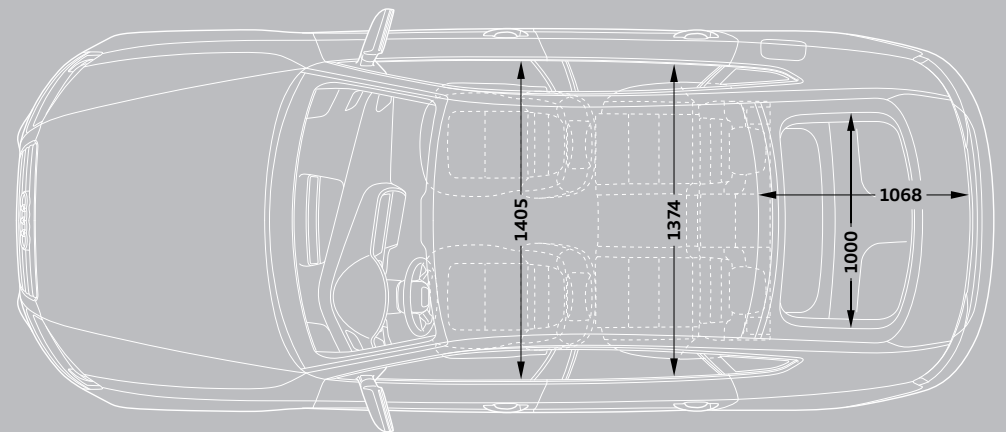
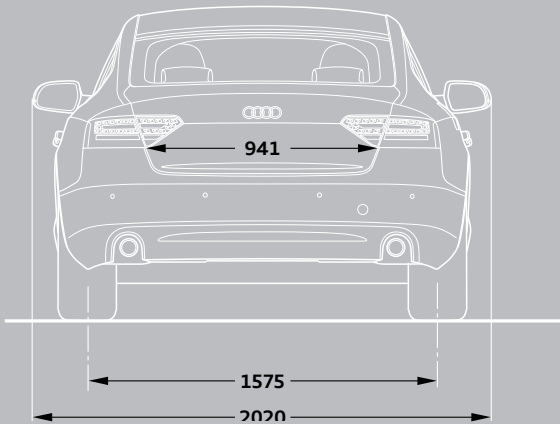
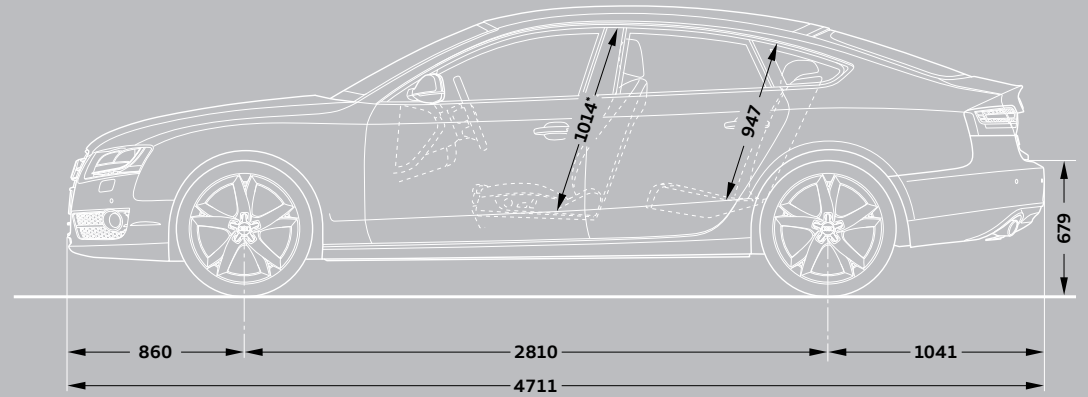
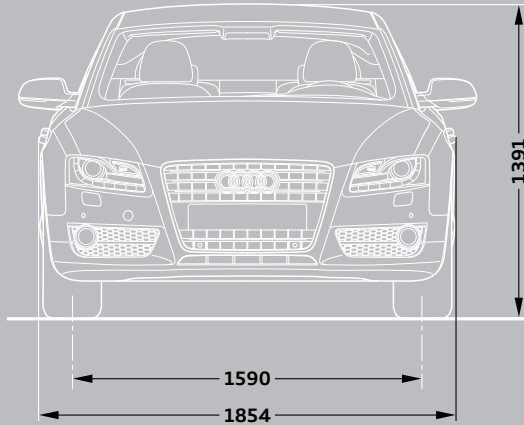

Dimensions were measured with vehicle at unladen weight.

Turning circle approx 11.5m.

Dimensions in millimetres.

*Maximum headroom.

S5 Sportback dimensions

The technical drawings opposite show the exact dimensions of the S5 Sportback, so you can check everything – from whether the car will fit in your garage to whether your luggage will fit in the boot.

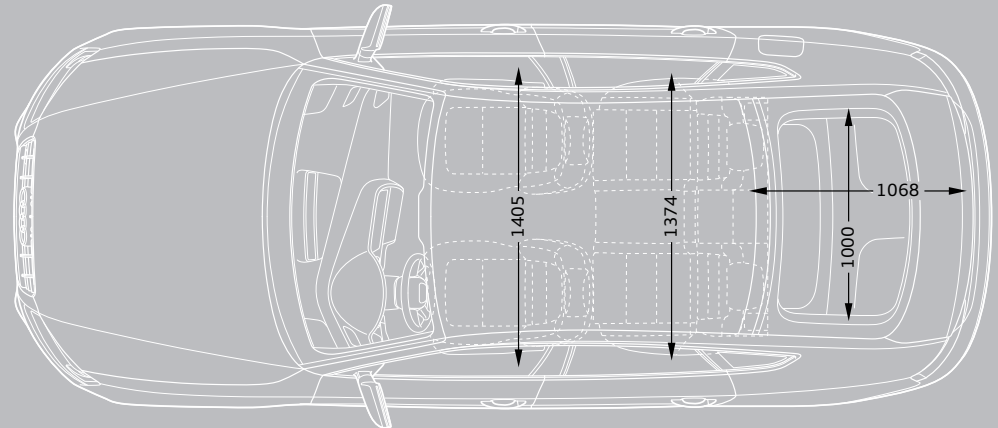
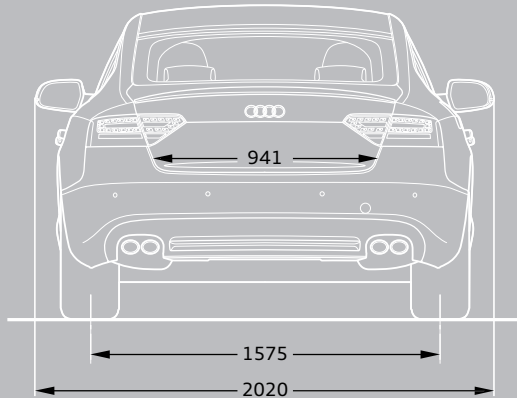
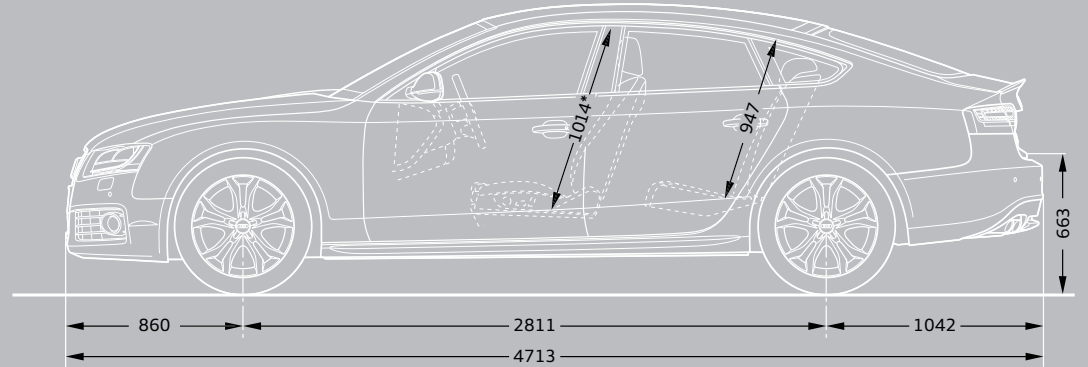
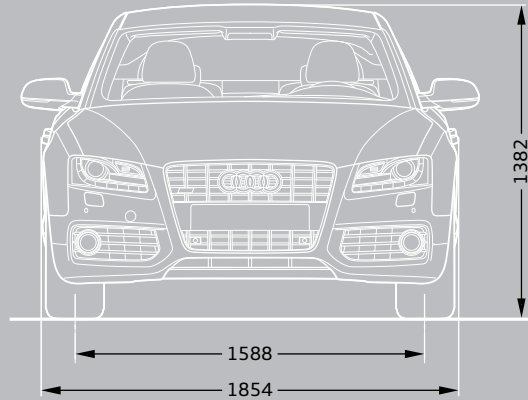

Dimensions were measured with vehicle at unladen weight.

Turning circle approx 11.5m.

Dimensions in millimetres.

*Maximum headroom.

Additional information

CO₂ data and information

CO₂ emissions-based Vehicle Excise Duty

Vehicle Excise Duty (Road Fund Licence) is based upon the amount of Carbon Dioxide (CO₂) a vehicle emits, measured in grams per kilometre (g/km). The DVLA has created thirteen categories:

Petrol and Diesel engines

A - up to 100g/km	£0.00
B - 101 to 110g/km	£35.00
C - 111 to 120g/km	£35.00
D - 121 to 130g/km	£120.00
E - 131 to 140g/km	£120.00
F - 141 to 150g/km	£125.00
G - 151 to 165g/km	£150.00
H - 166 to 175g/km	£175.00
I - 176 to 185g/km	£175.00
J - 186 to 200g/km	£215.00
K* - 201 to 225g/km	£215.00
L - 226 to 255g/km	£405.00
M - over 255g/km	£405.00

*Band K includes cars that have a CO₂ figure over 225g/km but were registered before 23 March 2006.

Vehicle Excise Duty (VED) rates correct at time of going to print, but these may alter to reflect any change in the applicable VED rate.

Servicing tailored to your needs

Regular servicing is key to safeguarding your Audi's performance and a full Audi service history could help you preserve the future re-sale value. To make servicing easy, the Audi Service Schedules have been designed to work with your individual driving style and vehicle.

There are two schedules available and your Audi Centre will advise which schedule is most suited to your needs. The conventional fixed Audi Inspection Service Schedule has fixed intervals for the Oil-change and Inspection Service that are based on time

and distance, whichever comes first. With the Audi LongLife Service Schedule, sensors take account of driving style and conditions in which the vehicle is used to indicate when the Oil-change Service is required. Oil-change Service intervals are therefore variable and are conveniently indicated via the on-board service interval display.

Fixed Inspection Service Schedule		Variable LongLife Service Schedule	
	Vehicle usage:		Vehicle usage:
Mileage	Less than 10,000 miles per annum	Mileage	More than 10,000 miles per annum
Type of journey	Mainly city/town centre driving. Short journeys	Type of journey	Motorway and main road driving. Mainly longer distance journeys. Constant speeds
Conditions	Frequent cold starts. High engine loading – e.g. frequent hill climbs, vehicle fully loaded, towing	Conditions	Normal engine loading – e.g. with little or no towing, with little or no hill climbs. Normal vehicle loading
Driving style	Uneconomical – e.g. heavy acceleration, heavy braking, constant changes in speed, constant use of high revs, 'sporty' driving	Driving style	Moderate acceleration, moderate braking, engine revs mainly below 3,000
	Service Intervals:		Service Intervals:
Oil-change Service	Fixed to every 9,000* miles/1 year	Oil-change Service	Variable to a maximum of every 19,000* miles/2 years
Inspection Service	Fixed to every 19,000* miles/2 years	Inspection Service	Fixed to every 19,000* miles/2 years

*As indicated by the service interval display. Mileages are approximate as the Service Indicator system uses kilometres as its distance measurement.

Additional information

Welcome to Audi

By placing an order for your Audi, you're choosing to get behind the wheel of one of the most sophisticated cars on the road. And because we believe the service we offer should be just as advanced, we wanted to let you know exactly what you can expect from us, now and in the future.

We've agreed a set of standards with all our Centres, which governs the way we do business with you. It outlines the kind of service we promise to deliver for every customer, right down to filling each new Audi we sell with half a tank of fuel.

So whether you're interested in the date your car will arrive in the UK or the way we'll dispose of non-biodegradable materials after we service your Audi, you can have total confidence in us.

Audi Promise

Audi Centres

We guarantee that all of our Centres will be open as follows;

Sales: Monday to Friday 9am–6pm
Saturday 9am–5pm

Service: Monday to Friday 8am–6pm
Saturday 8.30am–1pm

Sunday opening is at local discretion.

New car delivery

Once we've confirmed a delivery date for your car, we'll keep you informed of progress. Subject to reasonable notice, we'll then deliver it to a place of your choice, whether that's your home or place of work. In the unlikely event of a delay, we'll provide a courtesy car to minimise inconvenience and keep you mobile.

The experts in Vorsprung durch Technik

Would you entrust your Audi to anyone who hasn't been regularly trained to Audi standards? Our network of Audi Approved Master Technicians have undergone an impressive 100,000 hours of training over a 10-year programme to ensure they have the latest technical expertise for maintaining and servicing your Audi. All of our Service Advisors undergo a specialist induction and training to ensure they are Audi professionals and able to talk to you about any issues you may have with your Audi vehicle. What's more, we have so much expertise and experience in looking after Audi vehicles that we are able to make a note of your mileage and the state of your vehicle as and when we see it and predict when certain key events may occur. As part of our duty of care, we will notify you in plenty of time so you can make an appointment with us.

Your convenience comes first

At Audi you can choose from a range of convenient services that suit your needs. Why not book a 'service while you wait' appointment* and enjoy our complimentary refreshments while your car is with us? Or, if you need to be mobile, take advantage of one of our courtesy cars which we can even collect and deliver to you.* We guarantee we can service your Audi within 5 days without a courtesy car, or within 10 days if you need transport. We will also ensure your car is returned to you with a full valet.

Audi Genuine Parts

Would you put a part into your Audi that wasn't the same quality as the factory fitted original? You can rest assured that only Audi Genuine Parts will be used on your vehicle. What's more, Audi parts and labour come with a 2-year guarantee.** We stock a wide variety of parts, so we are well covered. However, if we don't have a part in stock at our Centre we have the back-up of parts at other Audi Centres, at our national warehouse and our factory and can usually source the relevant part very quickly.

We don't like surprises either

We believe strongly in transparency and there will be no hidden costs. For added peace of mind, we will give you a quotation over the phone for the work you have requested and email you the price confirmation. We'll consult you if any additional work on your car is needed when it is with us. We won't carry out any extra work without asking your permission first.

The Audi Stamp

Regular servicing is key to safeguarding your Audi's performance and a full Audi service history could help you preserve the future re-sale value of your car. Only the Audi Stamp will prove your approved Audi service history.

Getting better every time

We continually gather feedback from our Audi Trained Technicians, as well as our customers, to ensure our vehicles are running as they should. Whenever we see an Audi for a service, we connect it directly to our headquarters in Ingolstadt which enables us to check your car's software and make sure it's as up-to-date as possible. If the factory has released a software upgrade for your model, it can be applied immediately – improving anything from your car's efficiency to the precision of its parking system.

Environmental commitment

We promise to dispose of all non-biodegradable materials from your vehicle in a responsible manner

*Subject to availability.

**Excludes wear and tear.

Pricing information

Pricing

Prices and specifications given are correct at the time of printing. Always check details with your Audi Centre, as Audi policies are continually developing. We reserve the right to change prices or specifications at any time.

All prices are subject to VAT, currently charged at 17.5% but this may alter to reflect any change in the applicable VAT rate.

Delivery charges and number plates are not included in the vehicle price.

Delivery charge	£473.62
Number plate	£20.00
VAT	£86.38
Total	£580.00

Audi Roadside Assistance

Your new car comes complete with complimentary roadside assistance and recovery across the UK provided by RAC Motoring Services. Also included is roadside assistance throughout Europe, managed by RAC Motoring Services.

Audi Customer Care

Every new Audi benefits from the comprehensive Audi Customer Care Package, which comprises:

- ▶ A 3-year Audi warranty, which covers you for unlimited mileage in the first 2 years of ownership, with a full mechanical and electrical warranty which covers you for up to 60,000 miles in the 3rd year
- ▶ A 3-year paint warranty
- ▶ A 12-year anti-corrosion warranty
- ▶ 3 years' UK roadside assistance and recovery

This package, together with Audi variable service intervals, offers a combination unmatched by any other major manufacturer.

When you order your new car you can also choose to extend your Audi warranty to the lesser of: 4 years/75,000 miles or 5 years/90,000 miles. With full Audi warranty cover for up to 5 years, you'll be protected against unexpected repairs and should you sell your Audi before the warranty has expired it is fully transferable to subsequent owners.

Contact your Audi Centre for full details.

Audi Tax-Free Sales

If you are entitled to purchase a vehicle free of VAT, normally through Military or Diplomatic privilege, please contact your local Audi Centre for full details.

Should you have any difficulty obtaining the information you require, please call Freephone 0800 585878.

Audi Finance

Audi Finance specialise in providing funding solutions for Audi drivers. Whether your Audi is for private or business use, there are a range of funding options to choose from.

Below is the full range of finance products.

- ▶ Solutions – a Personal Contract Plan
- ▶ Hire purchase
- ▶ Lease purchase
- ▶ Finance lease
- ▶ Contract hire

With all products, you can choose a fixed-cost maintenance plan designed to help you budget accurately.

No matter what Audi model you choose, your local Audi Centre can provide you with a personalised quote which could fit your budget and motoring needs.

Audi Finance is a trading name of Volkswagen Financial Services (UK) Limited. An offer of finance depends on certain conditions. Available to people over 18 in the UK only.

Audi Insurance

We want you to start enjoying your new car from day one and thanks to Audi Insurance complimentary seven day cover, you can. Call free on 0800 316 7893 (lines are open Monday to Friday 8am - 9pm, and Saturday 9am - 5pm), provide a few details and a cover note will be sent to your Audi Centre. They will then tax your car and you can drive it away.

Audi UK

Customer Services
Selectapost 29
Sheffield
S97 3FG
0800 699888
audi.co.uk

Specifications and prices subject
to change without notice.

© Audi (UK)

Printed in the UK
Edition 3.0 12/09
2010 Model Year



Mixed Sources
Product group from well-managed
forests and other controlled sources

Cert no. TT-COC-002327
www.fsc.org
© 1996 Forest Stewardship Council