



The Audi A1

Pricing and Specification Guide

Valid from June 2010

Personalising your Audi A1

This guide has been designed to help you tailor and price your Audi A1 quickly and logically. At the back, you will find information on CO₂ emissions-based vehicle excise duty and the other services offered by Audi, including Servicing, Finance and Insurance. Alternatively, you can go to audi.co.uk and configure your Audi A1 online.

The Audi A1

Efficiency	8
Engines	10
Transmission	11
Technology	12

Model details and prices

SE model equipment	14
Sport model equipment	15
S line model equipment	16
Model prices	18

Colour and upholstery

Paint	20
Roof contrast line	22
Upholstery	24
Media style package	26
Colour and trim guide	28
Competition line	30
Air vent sleeves	32

Options

Wheels and tyres	34
Packages	36
Audio and communication	38
Steering wheels	40
Safety and security	40
Exterior equipment	41
Interior equipment	42
Service Plan and warranty	44
Merchandise	46
Accessories	47

Technical details

Technical data	48
Dimensions	50
Additional information	51
Pricing information	53
Augmented reality	Inside back cover





Vorsprung durch Technik

Three words that express the very essence of Audi. Vorsprung durch Technik isn't a slogan. It's our way of seeing the world. It is the driving force behind our history of innovation that continues into the 21st century. Indeed, many technologies that Audi pioneered remain in our cars today. Some are milestones in the history of the motorcar.

From our beginnings in 1899, to the Auto Union team's Grand Prix successes in the 1930s and our more recent wins at Le Mans, we have always been at the forefront of the motor industry.

Vorsprung durch Technik makes us who we are. To see more of its influence, just read on.

The Audi A1

Sometimes it's the smallest things that contain the biggest ideas: the humble paper clip, the tungsten filament, the pocket army knife. The Audi A1 is no exception. This new compact car is a distillation of all the great technologies which came before it – many of which appear in the flagship A8.

Featuring TDI® and FSI® engines born and bred on the racetrack and cutting edge technologies such as Start-Stop and S tronic,® this is amongst our most efficient cars.





Efficiency

At Audi, doing less is something we're trying to do more of. We're working to use less fuel, release less CO₂ and waste less energy. It's why we've incorporated a number of more efficient technologies into the Audi A1.

TDI® and FSI®

Inside the engine of the A1 you'll find the same advanced fuel-injection technology that's driven us to win after win at Le Mans. With TDI® and FSI®, fuel is injected directly into the engine's chambers so that combustion is timed right down to the millisecond. As a result, waste is minimised and you get the most from every last drop of fuel.

Start-Stop

In traffic, your car still uses fuel and releases CO₂, even when it's stationary. The automatic Start-Stop function is a smart new technology that counteracts this problem by being able to switch off the engine when your A1 comes to a standstill. As soon as you touch the clutch (or brake pedal on S tronic® models), the car restarts. By only using the engine when it's needed, it helps to save fuel and reduce emissions – especially in heavy urban traffic.





Recuperation

When a vehicle brakes, the discs convert the kinetic energy into thermal energy, which is wasted as it cannot be used. With a recuperation system, like the one in the Audi A1, the kinetic energy is converted into useful electrical energy. The way it works is simple. While the car is coasting or braking, the alternator voltage is raised above the level of the basic electrical system, which enables the alternator to generate electrical energy and store it temporarily in the battery. When the vehicle accelerates, this energy is used to relieve the load on the alternator, resulting in a fuel saving of up to 3%.

Engines

Petrol

FSI® direct-injection technology is a unique Audi innovation that was originally developed for the Le Mans 24-hour endurance race to deliver more power and torque, as well as enhanced fuel efficiency. Precisely the right amount of fuel and air are injected into the combustion chambers, enabling the engine to 'breathe' more easily. It results in reduced heat loss and increased output, with around a 15% reduction in fuel consumption and significantly lower exhaust emissions. We've also developed TFSI®, with turbocharging – giving cars an extra injection of power.

Diesel

We introduced TDI® to the roads in 1989, marking a departure from the noisy, fuel-thirsty diesel engines of the past. And since then, we've continuously refined it, recently developing common rail technology. Under this system, a series of piezo injectors use electrical charge to precisely control the amount of fuel injected into the engine. As well as reducing noise, this allows combustion to happen at a lower temperature, with less oxygen, which lowers emissions.





Transmission

S tronic®

Driving is all about thinking ahead, which is just what the S tronic® dual-clutch transmission does. It works almost as two separate systems, one engaging the odd-numbered and the other the even-numbered gears. So when you're accelerating in second, it has third gear waiting for you. And once you make the switch, it's already thinking about fourth. With two clutches working together, you can change gears almost instantly while experiencing smooth, uninterrupted power. S tronic® is available on 1.4 TFSI models.

Technology

Concert radio

A technologically advanced car needs a sound system to match – one designed to enhance the thrilling experience of every drive. The standard Concert radio incorporates an MP3-compatible CD player, AUX-IN socket, SD memory card reader and a 6.5-inch retractable display. Six high-performance speakers complete with two ‘tweeters’ work together to produce a sound to enliven any journey. With all this music at your fingertips, being stuck in traffic may become your favourite activity; but we’ve included an automatic traffic update programme (TP memo) anyway – just in case.

Satellite Navigation system – HDD-based

The Audi A1 keeps many of its most impressive technologies concealed beneath sculptured bodywork and interior finishing. The optional Satellite Navigation system – HDD-based, for example, gives you intuitive control of your car’s communication, information, navigation and entertainment functions. The MMI eight-way joystick lets you navigate maps quickly and easily in both 2D and 3D, while you can also use the Audi Music Interface to connect your iPod or the Bluetooth interface to stream music wirelessly from your mobile phone. There’s plenty of room to store your favourites too, with a sizeable 20-gigabyte hard drive. For more information, please see page 36.

BOSE® premium sound system

The A1’s exterior is a perfect example of modern design. This is complemented inside, where you’ll find state-of-the-art technology throughout the cabin. Options include a BOSE® premium sound system which includes 14 high performance speakers and a sub-woofer. The speaker housings are enhanced with bevelled edges. Thanks to a 10-channel amplifier, the speakers deliver 465 Watts of rich and clear sound, creating a rewarding listening experience – whatever kind of music you’re listening to. For more information, please see page 38.

LED technology

With Xenon headlights available as an option on S line, the LED daytime running lights provide a distinctive look with a unique, flowing design. Special reflectors focus the light emitted by each diode to create a powerful, uniform beam. And this technology extends to the rear lights, creating a striking design that is unmistakably Audi. For more information, please see page 41.





SE model equipment

All A1 models have the following items of standard equipment

Engine

Automatic Start-Stop function for greater fuel and CO₂ efficiency. Comprising;

- Recuperation for optimal energy utilisation
- Energy saving tips feature in Driver's Information System: including gearshift indicator (if Driver's Information System is fitted)

Wheels, tyres and suspension

15" x 6.5J '7-arm' design alloy wheels with 205/55 R15 tyres

Locking wheel bolts

Dynamic suspension with McPherson front axle and twist-beam rear suspension

Tyre repair kit

Audio and communication

6.5" display screen – manually retractable
AUX-IN socket

Concert radio/single CD player with MP3 file compatibility, 6 speakers in front and rear and 2 tweeters

SD card reader

Seats

Driver and front passenger seats with manual height adjustment

Easy-entry front seats

Split folding rear seats

'Zeitgeist' cloth upholstery

Safety and security

Driver, front passenger, front side and head airbag system

Front passenger airbag deactivation switch

ISOFIX child seat preparation for front passenger and rear seats

Electronic Stability Program (ESP), including ABS, EBD, ASR and EDL

First aid kit

Halogen headlights

Rear fog light

Rear head restraints (adjustable)

Seat belts – 3-point on all seats

Seat belt reminder for all seats

Thatcham Category 1 alarm and immobiliser

Remote central locking with 2 foldaway keys

Tool kit and car jack

Warning triangle

Exterior equipment

Body-coloured door mirrors with integrated indicators

Electrically operated door mirrors

Interior equipment

3-spoke Sports steering wheel

Steering wheel adjustable for height and reach

Air vent sleeves in matt black

Electric front windows

Heat-insulating glass windscreen and side windows

Front floor mats

Heated rear windscreen

Manual air conditioning

Non-smoking package

Washer fluid level indicator

Contrasting colour panels on doors, door armrest and centre console (see page 24)



15" x 6.5J '7-arm' design alloy wheels



Body-coloured door mirrors with integrated indicators



Air vent sleeves in matt black

Sport model equipment

In addition to SE model equipment

<p>Basic RRP £1,531.91</p> <hr/> <p>Total RRP inc VAT £1,800.00</p>

Wheels, tyres and suspension

16" x 7J '10-spoke' design alloy wheels with 215/45 R16 tyres

Sports suspension with stiffer spring and damper settings (Dynamic suspension is available in lieu of Sports suspension at no charge)

Audio and communication

Mobile phone preparation – Bluetooth interface
Voice control

Seats

Front Sports seats
Manually adjustable lumbar support in front seats
'Tornado' cloth upholstery

Exterior equipment

Front fog lights
Polished tailpipe(s)

Interior equipment

3-spoke leather Sports multi-function steering wheel with aluminium inlay
Driver's Information System
Air vent sleeves in high gloss black
Aluminium trim for control switches, glove compartment, door handles and door sills
Leather handbrake grip and Sports gear knob with aluminium trim

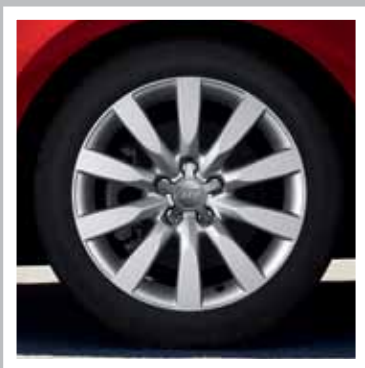

16" x 7J '10-spoke' design alloy wheels



Front fog lights



3-spoke leather Sports multi-function steering wheel



Air vent sleeves in high gloss black

RRP – Recommended Retail Price. VAT is calculated at 17.5% but this may alter to reflect any change in the applicable VAT rate.

S line model equipment

In addition to Sport model equipment

Basic RRP
£1,289.36

Total RRP inc VAT
£1,515.00

Wheels, tyres and suspension

17" x 7.5J '5-twin-spoke' design alloy wheels with 215/40 R17 tyres
S line Sports suspension

Seats

Black 'Sprint' cloth/leather upholstery with embossed S line logo in front seats

Exterior equipment

S line badges on front wings
S line body styling, comprising radiator grille in high gloss black, front sports bumper, side skirts and rear bumper with diffuser
S line roof spoiler

Interior equipment

3-spoke leather Sports multi-function steering wheel with aluminium inlay, S line badging and perforated leather trim

Black cloth headlining

Door sills with aluminium inlays and S line lettering

Floor mats

LED interior light package. Includes illuminated door handles, footwell lighting, illuminated vanity mirrors, illuminated glovebox, front reading lights and ambient lighting of the centre console



Door sills with aluminium inlays and S line lettering



17" x 7.5J '5-twin-spoke' design alloy wheels



A1 SE

Engines	Power	Transmissions	Basic RRP	Total RRP inc VAT	Recommended OTR
1.2 TFSI	86PS	5-speed manual	£10,646.81	£12,510.00	£13,145.00
1.6 TDI	105PS	5-speed manual	£11,527.66	£13,545.00	£14,180.00

A1 Sport

Engines	Power	Transmissions	Basic RRP	Total RRP inc VAT	Recommended OTR
1.2 TFSI	86PS	5-speed manual	£12,178.72	£14,310.00	£14,945.00
1.4 TFSI	122PS	6-speed manual	£12,519.15	£14,710.00	£15,345.00
1.4 TFSI	122PS	7-speed S tronic	£13,727.66	£16,130.00	£16,765.00
1.6 TDI	105PS	5-speed manual	£13,059.57	£15,345.00	£15,980.00

A1 S line

Engines	Power	Transmissions	Basic RRP	Total RRP inc VAT	Recommended OTR
1.2 TFSI	86PS	5-speed manual	£13,468.09	£15,825.00	£16,460.00
1.4 TFSI	122PS	6-speed manual	£13,808.51	£16,225.00	£16,860.00
1.4 TFSI	122PS	7-speed S tronic	£15,017.02	£17,645.00	£18,280.00
1.6 TDI	105PS	5-speed manual	£14,348.94	£16,860.00	£17,495.00

For engine and model availability please refer to your Audi Centre.

Please note: The maximum power output figures are quoted in PS (or Pferdestärke, which is the metric equivalent of brake horsepower). To convert to brake horsepower, divide the PS figure by 1.0139.

Recommended On-The-Road (OTR) retail prices include: delivery charge, half a tank of fuel, number plates at £580.00 (inc. VAT), Road Fund Licence (which may vary depending on model/transmission - see page 51 for details) and first registration fee at £55.00. Vehicle Excise Duty correct at time of going to print, but this may alter to reflect any change in the applicable VED rate.

RRP - Recommended Retail Price. VAT is calculated at 17.5% but this may alter to reflect any change in the applicable VAT rate.





Paint

You can select one of the standard colours shown opposite or, for a different look, choose from the range of optional gloss, metallic or pearl effect finishes.

Standard colours

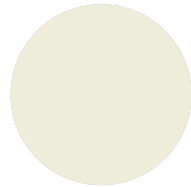

Amalfi white, gloss - Y5

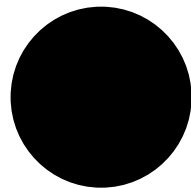

Brilliant black, gloss - A2

Optional colours

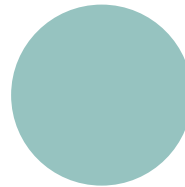

Cumulus blue, gloss - U4

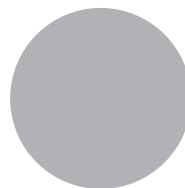

Ice silver, metallic - P5

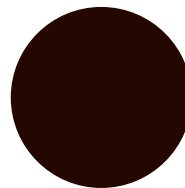

Teak brown, metallic - 4U

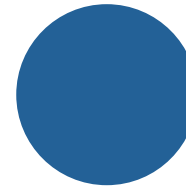

Scuba blue, metallic - S9

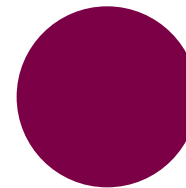

Shiraz red, metallic - 3A

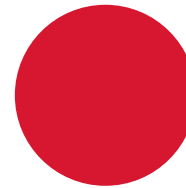

Misano red, pearl effect - N9

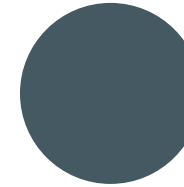

Sphere blue, metallic - 9F

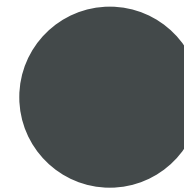

Daytona grey, pearl effect* - 6Y

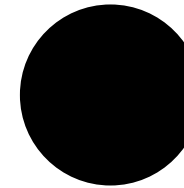

Phantom black, pearl effect - L8

Options are subject to availability and may extend delivery.

All the colour swatches on this page are matched as accurately as possible to the actual paint colours used. However, due to print processes, Audi UK cannot guarantee that colours shown are 100% accurate.

Visit your local Audi Centre for a more accurate colour swatch.

*S line colour only.

RRP - Recommended Retail Price.

VAT is calculated at 17.5% but this may alter to reflect any change in the applicable VAT rate.

Cumulus blue optional colour

Basic RRP
£165.96

Total RRP inc VAT
£195.00

Other optional colours

Basic RRP
£425.53

Total RRP inc VAT
£500.00



Roof contrast line

Choose one of the optional roof contrast line colours opposite to complement your paint, enhancing the design of your A1.

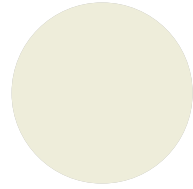

Amalfi white, gloss - Y5

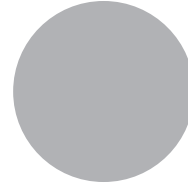

Ice silver, metallic - P5

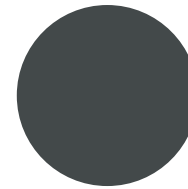

Daytona grey, pearl effect - 6Y

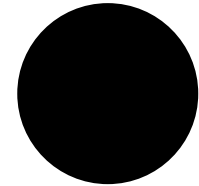

Brilliant black, gloss - A2

Roof contrast line

Basic RRP
£293.62

Total RRP inc VAT
£345.00



Roof contrast line

Paint and roof contrast line combinations

To help you choose the exterior design of your A1, please use this guide which shows possible paint and roof contrast line combinations.

Order Code		Amalfi white, gloss (Y5)	Ice silver, metallic (P5)	Daytona grey, pearl effect (6Y)	Brilliant black, gloss (A2)
Y5	Amalfi white, gloss	-	-	●	-
A2	Brilliant black, gloss	-	-	-	-
U4	Cumulus blue, gloss	-	-	-	-
P5	Ice silver, metallic	-	-	-	-
S9	Scuba blue, metallic	-	●	-	-
3A	Shiraz red, metallic	-	●	-	-
9F	Sphere blue, metallic	-	-	-	●
4U	Teak brown, metallic	●	-	-	-
L8	Phantom black, pearl effect	-	●	-	-
6Y	Daytona grey, pearl effect	-	●	-	-
N9	Misano red, pearl effect	-	●	-	-

Options are subject to availability and may extend delivery.

- = Not available
 ● = Available
 S = Standard

Upholstery

A1 SE models

Your chosen upholstery will be complemented with a contrasting centre console, door armrest and door panels including speaker housings. When black upholstery is chosen, these panels will be trimmed in black with contrasting grey stitching.

Air vent sleeves are also available to complement your upholstery colour – see page 32 for more details.





Options are subject to availability and may extend delivery.

- = Not available
- = Available
- S = Standard
- P = Available as part of a package
- see page 26 for details

All leather upholstery choices include seats, head restraints, door inserts and front centre armrest (if fitted) in leather.

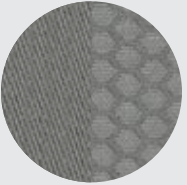
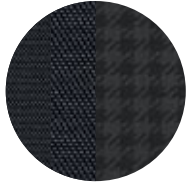
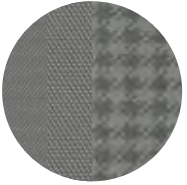
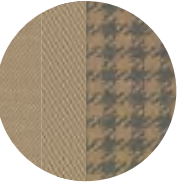
RRP – Recommended Retail Price.

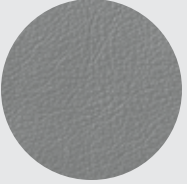
VAT is calculated at 17.5% but this may alter to reflect any change in the applicable VAT rate.

	SE	Sport	S line	Basic RRP	Total RRP inc VAT
Zeitgeist cloth  	S	-	-	No charge	No charge
Style cloth    <p>Only available in combination with Media Style package – see page 26 for further details</p>	P	-	-	No charge	No charge
Milano leather    <p>Only available in combination with Media style package – see page 26 for further details</p>	P	-	-	£1,021.28	£1,200.00

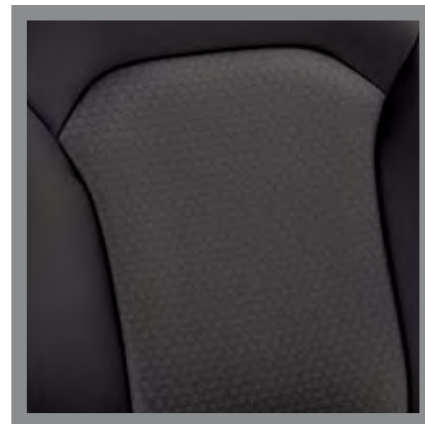

Black Zeitgeist cloth – YM

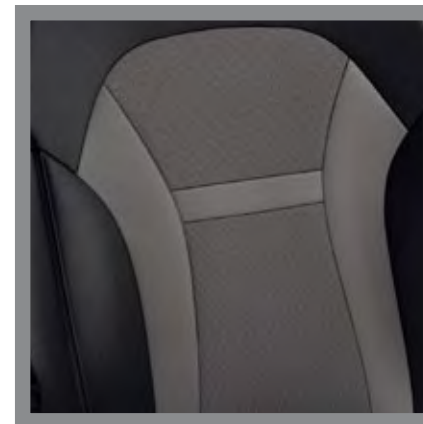

Black/Titanium grey Tornado cloth – FK

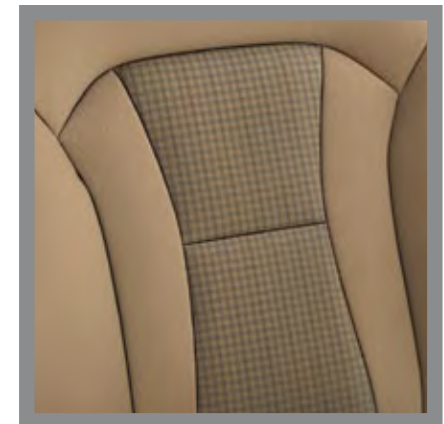





Velvet beige Style cloth – YQ

Upholstery

A1 Sport models

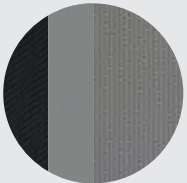
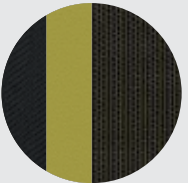
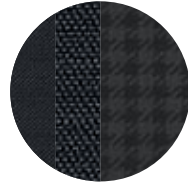
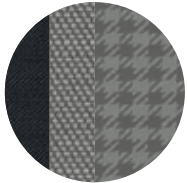
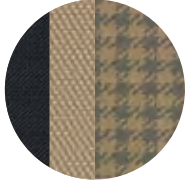
Choose your favourite upholstery from the swatches shown opposite to give your car's interior the look and feel you want.

All Sport model upholstery colours receive contrast colour seat stitching.

	SE	Sport	S line	Basic RRP	Total RRP inc VAT
Tornado cloth  Black - YS  Black/Titanium grey - FK  Black/Wasabi green - YP	-	S	-	No charge	No charge
Style cloth  Black/Black - YS  Black/Titanium grey - FK  Black/Velvet beige - YR <p>Only available in combination with Media Style package - see page 26 for further details</p>	-	P	-	No charge	No charge
Milano leather  Black/Black - YS  Black/Titanium grey - FK  Black/red - YN	-	●	-	£1021.38	£1,200.00
Sprint cloth/leather  Black - QZ	-	-	S	No charge	No charge

A1 S line models

Options are subject to availability and may extend delivery.

- = Not available
- = Available
- S = Standard
- P = Available as part of a package - see page 26 for details

All leather upholstery choices include seats, head restraints, door inserts and front centre armrest (if fitted) in leather.

RRP - Recommended Retail Price.

VAT is calculated at 17.5% but this may alter to reflect any change in the applicable VAT rate.

Media Style package

This package provides a distinctive look and feel for your car's cabin, enabling you to integrate the audio system with your digital music player and stay in touch using Bluetooth technology.

You can also upgrade to a leather interior and choose contrasting air vent sleeve colours – see page 32.

Options are subject to availability and may extend delivery.

– = Not available
• = Available
S = Standard

RRP – Recommended Retail Price.

VAT is calculated at 17.5% but this may alter to reflect any change in the applicable VAT rate.

	SE	Sport	S line	Basic RRP	Total RRP inc VAT
WMS 1XW	•	–	–	£1,136.17	£1,335.00
	–	•	–	£451.06	£530.00

Media Style package: Includes Audi Music Interface, Bluetooth interface, Driver's Information System, leather multi-function steering wheel and LED interior light package. Also includes 'Style' cloth upholstery, air vent sleeves in high gloss black or contrasting colour to your interior. Centre console, door armrest, door panels and speaker housings in contrasting colour leather-style finish. Not in combination with Competition line interior styling package

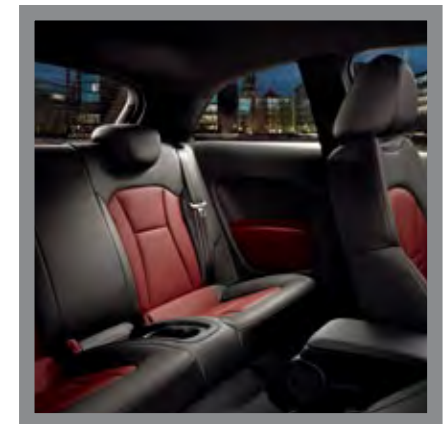
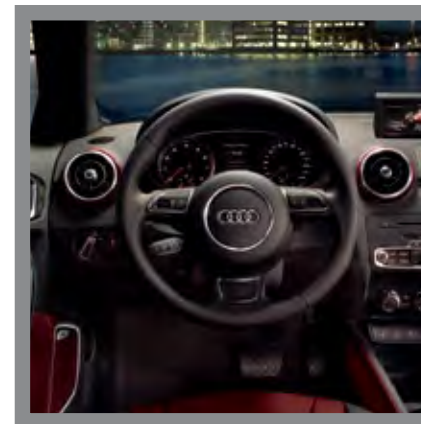
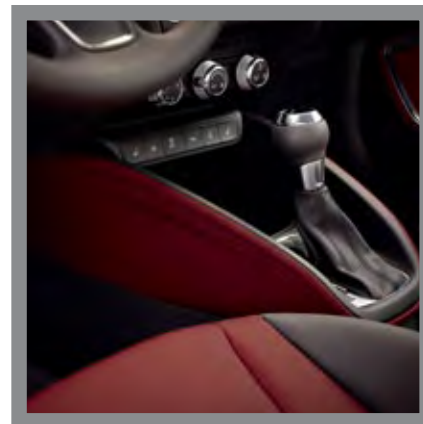

Media Style package with optional Milano leather in Black/red – YN



Colour and trim guide

Interior trim colours

SE models

To help you choose the right interior for your new Audi A1, please use this guide, showing the carpet, dashboard and headlining colours that have been matched to your chosen upholstery.

Order Code	Seat centre section	Seat side section	Contrast stitching	Dashboard	Carpet	Centre console, armrest, map pocket, speaker grilles	Headlining	Zeitgeist cloth (N0L)	Media Style package	
									Style cloth (N2D)	Milano leather (N5W)
YM	Black	Black	–	Black	Black	Black	Titanium grey	●	●	●
FH	Titanium grey	Titanium grey	–	Black	Titanium grey	Titanium grey	Titanium grey	●	●	●
YQ	Velvet beige	Velvet beige	–	Black	Black	Velvet beige	Titanium grey	–	●	●

Sport models

Order Code	Seat centre section	Seat side section	Contrast stitching	Dashboard	Carpet	Centre console, armrest, map pocket, speaker grilles	Headlining	Tornado cloth (N2T)	Media Style package	
									Style cloth (N2D)	Milano leather (N5W)
YS	Black	Black	Grey	Black	Black	Black	Titanium grey	●	●	●
FK	Titanium grey	Black	Titanium grey	Black	Black	Titanium grey	Titanium grey	●	●	●
YP	Wasabi green	Black	Wasabi green	Black	Black	Wasabi green	Titanium grey	●	–	–
YN	Red	Black	Red	Black	Black	Red	Titanium grey	–	–	●
YR	Velvet beige	Black	Velvet beige	Black	Black	Velvet beige	Titanium grey	–	●	–

S line models

Order Code	Seat centre section	Seat side section	Contrast stitching	Dashboard	Carpet	Centre console, armrest, map pocket, speaker grilles	Headlining	Sprint cloth/ leather (N7V)	
								Style cloth (N2D)	Milano leather (N5W)
QZ	Black	Black	Grey	Black	Black	Black	Black	●	–

Options are subject to availability and may extend delivery.

- = Not available
- = Available
- S = Standard



Competition line

The Competition line styling options are created from our unique range of Audi accessories, including key design features inspired by the early Audi quattro rally cars.

Only available when ordering your new A1.

		SE	Sport	S line	Basic RRP	Total RRP inc VAT
YIA	Interior styling package. Includes Competition line design floor mats, door handles, centre console trim and rear-view mirror trim. Also includes air vent sleeves in high gloss white. Not available in combination with Media Style package. Only in combination with black upholstery	-	●	-	£361.70	£425.00
YNE CP2	Exterior styling package. Includes front spoiler, double-blade roof spoiler, side skirts, rear diffuser in gloss black, stainless steel tailpipe trims and 17" '5-arm' design alloy wheels	-	●	-	£1,659.57	£1,950.00
YNH	Double-blade roof spoiler. Included in exterior styling package	-	●	-	£336.17	£395.00

Options are subject to availability and may extend delivery.

- = Not available
- = Available
- S = Standard

RRP – Recommended Retail Price.

VAT is calculated at 17.5% but this may alter to reflect any change in the applicable VAT rate.



Interior styling package



Exterior styling package including roof spoiler

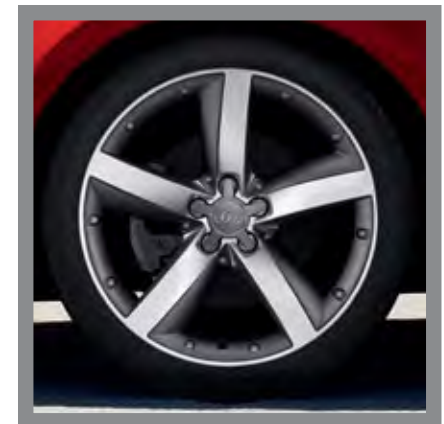

17" '5-arm' design alloy wheels



Please note: image shows the Audi A1 with the Competition line exterior styling package. The 18" '5-arm Polygon style' design alloy wheels shown are available as an additional option via Audi accessories. Please contact your local Audi Centre for details.

Air vent sleeves

Choose an air vent sleeve to complement or contrast with your chosen interior colour.

Matt finish

High gloss finish



Matt black - 5MA



Black - 5MB



Titanium grey - 5MC



White - 5MJ



Velvet beige - 5MQ



Red - 5ML



Wasabi green - 5MN

Options are subject to availability and may extend delivery.

- = Not available
• = Available
S = Standard

RRP - Recommended Retail Price.

VAT is calculated at 17.5% but this may alter to reflect any change in the applicable VAT rate.

Air vent sleeves

Order Code		SE	Sport	S line	Basic RRP	Total RRP inc VAT
5MA	Matt black	S	-	-	No charge	No charge
5MB	High gloss black	●	S	S	£85.11	£100.00
-	High gloss colour contrast. Available in 5 colours. See opposite page for colour availability. Please note that colour contrasting air vent sleeves are only available in combination with the corresponding interior colour or black	●	●	-	£85.11	£100.00
	Only in combination with Media Style package	S	S	-	No charge	No charge

Options are subject to availability and may extend delivery.

- = Not available
- = Available
- S = Standard

RRP – Recommended Retail Price.

VAT is calculated at 17.5% but this may alter to reflect any change in the applicable VAT rate.

Wheels, tyres and suspension

Choose a set of specially-selected alloy wheels to subtly enhance the way your A1 looks.



15" x 6.5J '6-hole' design
bi-colour alloy wheels - C5L



16" x 7J '7-arm dynamic'
design alloy wheels - CQ3



17" x 7.5J '5-arm'
design bi-colour alloy wheels - CP2



17" x 7.5J '5-V-spoke'-design
bi-colour alloy wheels - CP3



18" x 7.5J '7-twin-spoke'
design alloy wheels - C6L

Wheels, tyres and suspension

Order Code		SE	Sport	S line	Basic RRP	Total RRP inc VAT
C5L	15" x 6.5J '6-hole' design bi-colour alloy wheels with 205/55 R15 tyres	●	-	-	£127.66	£150.00
CQ3	16" x 7J '7-arm dynamic' design alloy wheels with 215/45 R16 tyres	-	●	-	£127.66	£150.00
CP2	17" x 7.5J '5-arm' design bi-colour alloy wheels with 215/40 R17 tyres	-	●	-	£382.98	£450.00
CP3	17" x 7.5J '5-V-spoke' design bi-colour alloy wheels with 215/40 R17 tyres	-	●	-	£468.09	£550.00
C6L	18" x 7.5J '7-twin-spoke' design alloy wheels with 225/35 R18 tyres	-	-	●	£340.43	£400.00
UC0	Dynamic suspension. McPherson front axle and twist-beam rear suspension	-	●	-	No charge	No charge

Options are subject to availability and may extend delivery.

- = Not available
● = Available
S = Standard

RRP – Recommended Retail Price.

VAT is calculated at 17.5% but this may alter to reflect any change in the applicable VAT rate.

Packages

Some items work well together, which is why we've created these special packages. They provide increased convenience and value by combining several of our most popular options.

Order Code		SE	Sport	S line	Basic RRP	Total RRP inc VAT
WBI	Comfort package. Acoustic parking system (rear only), cruise control, auto-dimming rear-view mirror and light and rain sensor package	●	●	●	£502.13	£590.00
PNQ 1XW	Technology package. Satellite Navigation system – HDD-based with Audi Music Interface, Bluetooth interface with Bluetooth audio streaming and leather multi-function steering wheel. Route planning and guidance using voice, pictogram and 3D mapping. Includes AM/FM tuner with TP memo function. Single front-loading CD/DVD player with MP3 compatibility, suitable for audio and DVD playback. Third generation MMI system including high-resolution (800x480) 6.5" colour TFT display, two SD card readers and 40GB hard drive, 20GB of which can be used to store songs. HDD Navigation functionality includes advanced speech recognition, 3D and topographical mapping display and advanced 3D building display Only in combination with Media Style package	-	●	●	£1,144.68	£1,345.00
		-	●	-	£1,021.28	£1,200.00

Options are subject to availability and may extend delivery.

- = Not available
- = Available
- S = Standard

RRP – Recommended Retail Price.

VAT is calculated at 17.5% but this may alter to reflect any change in the applicable VAT rate.



3-spoke leather Sports multi-function steering wheel



Satellite Navigation – HDD based



Audio and communication

Stay in touch using our range of communication functions, and give each journey its own soundtrack with our advanced audio equipment.

You can also opt for the technology package, which combines many of the features shown here with Satellite Navigation system – HDD-based. See page 36 for further details

Options are subject to availability and may extend delivery.

- = Not available
- = Available
- S = Standard

*When combined with Technology package.

RRP – Recommended Retail Price.

VAT is calculated at 17.5% but this may alter to reflect any change in the applicable VAT rate.

Order Code		SE	Sport	S line	Basic RRP	Total RRP inc VAT
9Q7	Driver's Information System (DIS)	•	S	S	£157.45	£185.00
9V3	DAB digital radio. Integrated into MMI, receives digitally-transmitted radio stations in addition to the range of analogue stations. Displays music track, artist and radio program. Capable of 'DAB Slideshow' where transmitted. Reception dependent on local digital network. Automatic switch from DAB to FM reception if the network signal is not strong enough. Only in combination with Driver's Information System, multi-function steering wheel and connectivity package	•	•	•	£255.32	£300.00
9VD	Audi sound system. Includes 6-channel amplifier, 6 loudspeakers in front and rear, 2 tweeters in A-posts, centre speaker in dashboard and subwoofer. Total output of 180 Watts	•	•	•	£212.77	£250.00
9VK	BOSE® premium sound system. 5.1 surround sound* with dynamic noise-compensation, 10-channel amplifier, 14 loudspeakers including centre speaker in the dashboard and 2 surround loudspeakers in the rear shelf. Total output of 465 Watts. Speaker housings with bevelled edge and lighting for door speakers. Only in combination with LED interior light package. Not available on 1.4 TFSI Sport S tronic	•	•	•	£574.47	£675.00
9NU	Satellite Navigation system – SD card-based. Route planning and guidance using voice, pictogram and 2D mapping. Includes AM/FM tuner with TP memo function. Single front-loading CD player with MP3 compatibility. Third generation MMI system including high resolution (800X480) 6.5" colour TFT display and two SD card readers (one of which is used by the Navigation SD card). Navigation functionality includes advanced speech recognition. Also includes Audi Music Interface and Bluetooth interface with Bluetooth audio streaming. Only in combination with Driver's Information System and multi-function steering wheel	•	-	-	£978.72	£1,150.00
		-	•	•	£727.66	£855.00
9NV	Connectivity package. Bluetooth interface including voice control and Audi Music Interface. Also includes Bluetooth audio streaming and additional SD card reader. Only in combination with Driver's Information System and multi-function steering wheel	•	-	-	£502.13	£590.00
		-	•	•	£251.06	£295.00



BOSE® premium sound system

Audio and communication

Order Code		SE	Sport	S line	Basic RRP	Total RRP inc VAT
9ZX	Mobile telephone preparation – Bluetooth interface. Provides handsfree connection via Bluetooth using mobile phone aerial. Please contact your Audi Centre for phone compatibility. Only in combination with Driver's Information System and multi-function steering wheel	●	S	S	£251.06	£295.00
9ZF	Mobile telephone preparation – Low with Bluetooth. Provides handsfree connection via Bluetooth using mobile phone aerial. Alternatively, it can use a cradle with charging facility for optimal reception via external aerial. Cradle available at extra cost – please contact your Audi Centre for phone compatibility. Includes front centre armrest. Only in combination with Driver's Information System and multi-function steering wheel	●	-	-	£506.38	£595.00
		-	●	●	£255.32	£300.00
7A2	CD changer. For six CDs with MP3 compatibility	●	●	●	£319.15	£375.00

Options are subject to availability and may extend delivery.

- = Not available
- = Available
- S = Standard

RRP – Recommended Retail Price.

VAT is calculated at 17.5% but this may alter to reflect any change in the applicable VAT rate.



Mobile telephone preparation

Steering wheels

You can choose from a selection of advanced leather multi-function steering wheels, allowing you to control your audio system at the touch of a button.

Order Code		SE	Sport	S line	Basic RRP	Total RRP inc VAT
2PV	3-spoke leather Sports steering wheel	●	–	–	£136.17	£160.00
1XW	3-spoke leather Sports multi-function steering wheel. Only in combination with Driver's Information System	●	S	S	£268.09	£315.00
1XX	3-spoke leather Sports multi-function steering wheel with gear-shift paddles (S tronic models only)	–	●	●	£80.85	£95.00

Safety and security

Intelligent technology designed to give you better all-round awareness and safety on the road.

7X1	Acoustic parking system (rear only). Aids parking by acoustically indicating distances to obstacles	●	●	●	£255.32	£300.00
7X4	Audi parking system plus. Aids parking by acoustically and visually indicating distances to obstacles	●	●	●	£446.81	£525.00
8WB	Front fog lights	●	S	S	£114.89	£135.00
7K6	Tyre pressure loss indicator. A visual and acoustic warning when the system detects a potential loss of tyre pressure	●	●	●	£46.81	£55.00
UG4	Audi hill-hold assist. Prevents roll-back on hills for up to 5 seconds by maintaining brake force (standard with S tronic transmission)	●	●	●	£55.32	£65.00

Options are subject to availability and may extend delivery.

- = Not available
- = Available
- S = Standard

RRP – Recommended Retail Price.

VAT is calculated at 17.5% but this may alter to reflect any change in the applicable VAT rate.

Exterior equipment

Make sure your car looks exactly as you want it to by selecting some of our striking options.

Order Code		SE	Sport	S line	Basic RRP	Total RRP inc VAT
PAF	Door mirrors – heated and folding. Includes heated washer nozzles	●	●	●	£187.23	£220.00
8N7	High-beam assist. Automatically adjusts headlights from high-beam to dipped-beam when another vehicle is approaching. Only in combination with light and rain sensor package and Driver's Information System	●	●	●	£102.13	£120.00
PX4	Xenon Plus headlights. Includes LED daytime-running lights, rear LED lights, automatic headlight adjustment, dynamic range control and headlight washers	–	–	●	£638.30	£750.00
3FB	Open sky panoramic sunroof. Comprising glass roof with electric slide-and-tilt control and sunshade at front and rear. Only in combination with LED interior light package. Not available on 1.4 TFSI Sport S tronic	●	●	●	£744.68	£875.00
2Z0	Delete model and engine technology designation	●	●	●	No charge	No charge

Options are subject to availability and may extend delivery.

- = Not available
- = Available
- S = Standard

RRP – Recommended Retail Price.

VAT is calculated at 17.5% but this may alter to reflect any change in the applicable VAT rate.



Xenon Plus headlights



LED rear lights (included with Xenon Plus headlights)

Interior equipment

Specify every detail of your car's interior with this wide range of options.

Order Code		SE	Sport	S line	Basic RRP	Total RRP inc VAT
4F2	Advanced key. Access and authorisation system which automatically exchanges data between key and vehicle, allowing the driver to keep the key in their pocket or bag at all times. To unlock and open, simply lift the driver door handle. To lock, press the button on the handle. Pressing the start/stop button integrated in the centre console starts and stops the engine	●	●	●	£251.06	£295.00
8T2	Cruise control. For holding any speed above 25mph	●	●	●	£195.74	£230.00
9AK	Electronic climate control. Automatically controls the air temperature, flow rate and distribution including light, rain and humidity sensor, automatic air recirculation and defrost button for rapid defrosting of windscreen	●	●	●	£276.60	£325.00
4A3	Heated front seats. Individually controlled variable temperature adjustment	●	●	●	£212.77	£250.00
QQ1	LED interior light package. Includes illuminated door handles, footwell lighting, illuminated vanity mirrors, illuminated glovebox, front reading lights and ambient lighting of the centre console	●	●	S	£114.89	£135.00
4L6 8N6 4GP	Light and rain sensor package. Includes auto-dimming rear-view mirror, automatic headlight activation, automatic windscreen wipers, coming home/leaving home function and sun band for windscreen	●	●	●	£263.83	£310.00

Options are subject to availability and may extend delivery.

- = Not available
- = Available
- S = Standard

RRP – Recommended Retail Price.

VAT is calculated at 17.5% but this may alter to reflect any change in the applicable VAT rate.

Interior equipment

Order Code		SE	Sport	S line	Basic RRP	Total RRP inc VAT
QE4	Luggage package. Comprising combi-net for fixing into luggage compartment, 12V socket, additional light within luggage compartment, bag hooks, tensioning strap and storage compartment under load floor	●	●	●	£80.85	£95.00
QE1	Storage package. Comprising storage nets on front-seat backrests, storage compartment under front passenger seat, net on side of centre console, bag hooks on left and right in rear passenger compartment, storage compartment with cupholder in between rear passenger seats and a lockable glove compartment	●	●	●	£93.62	£110.00
6NQ	Cloth headlining – black. Only in combination with LED interior light package	●	●	S	£136.17	£160.00
6E3	Front centre armrest with storage compartment	●	●	●	£102.13	£120.00
0TD	Rear floor mats	●	●	●	£38.30	£45.00
9JD	Smoker's package. Includes ashtray and cigarette lighter. Replaces storage compartment and 12V socket	●	●	●	£12.77	£15.00

Options are subject to availability and may extend delivery.

- = Not available
- = Available
- S = Standard

RRP – Recommended Retail Price.

VAT is calculated at 17.5% but this may alter to reflect any change in the applicable VAT rate.



Electronic climate control



Heated front seats

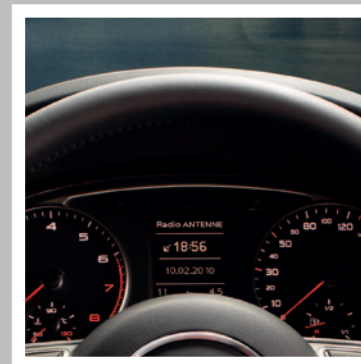

Driver's Information System



Front centre armrest

Service Plan

Choosing an Audi Service Plan provides an easy way to cover all your car's scheduled servicing with a one-off payment. It can take care of everything from fluid and filter changes to your full service, ensuring you retain a full Audi service history. There are no servicing bills to plan for and you'll continue to benefit from today's prices for the length of your agreement.

Order Code	SE	Sport	S line	Basic RRP	Total RRP inc VAT
-	●	●	●	£212.77	£250.00

Warranty

Order Code	SE	Sport	S line	Basic RRP	Total RRP inc VAT
-	S	S	S	No charge	No charge
EA6	●	●	●	£195.74	£230.00
EA9	●	●	●	£417.02	£490.00

*Retail customers only

**Only available when ordering your new A1. Speak to your Audi Centre for full details.

Options are subject to availability and may extend delivery.

- = Not available
● = Available
S = Standard

RRP - Recommended Retail Price.

VAT is calculated at 17.5% but this may alter to reflect any change in the applicable VAT rate.



Merchandise

From the enthusiasts' motorsport collection to the sophisticated Audi collection, there's a wide variety of adults' and children's clothing, lifestyle accessories and collectables, all of which bear the Audi name.

Please speak to a member of our team at your local Audi Centre to see the full Audi collection and to place an order. A selection of Audi merchandise is also available to buy from audi.co.uk/merchandise.



Audi kids



Bags and leather goods



Clothing



Motorsports



Sport and travel



Model cars

Accessories

Choosing an Audi isn't just a matter of deciding on the model you want; it's about creating a car that suits your needs perfectly. And that's why we've developed a whole range of accessories to enhance your A1, enabling you to customise it down to the last detail. Like your Audi, all these accessories are developed to the highest possible standards. And they're all available exclusively from Audi. To find out more, just visit your local Audi Centre.

Warranty

All of the accessories available on the A1 are covered by a three-year warranty* if they are ordered and included in the purchase price of the car at date of delivery. Any accessories ordered and installed after delivery include a two-year warranty.*

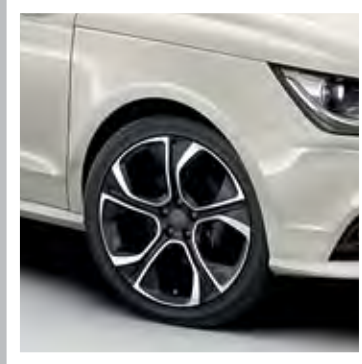

Sport and design

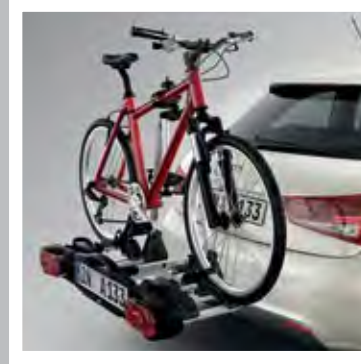

Transport and touring



Entertainment and communication

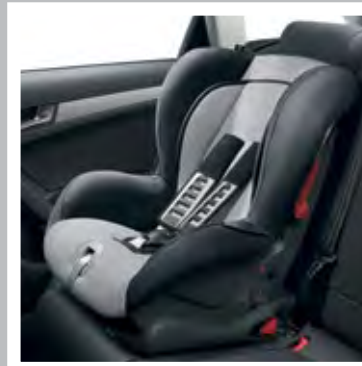

Family



Transport and touring



Safety and security

*Excluding Road Angel products.

Audi Accessories warranty terms and conditions can be found at audi.co.uk

A1

technical data

Engine	Petrol				Diesel
	1.2 TFSI	1.4 TFSI	1.4 TFSI Sport	1.4 TFSI S line	1.6 TDI
Transmission	5-speed manual	6-speed manual	7-speed S tronic	7-speed S tronic	5-speed manual
Cylinder	4-cylinder	4-cylinder	4-cylinder	4-cylinder	4-cylinder
Displacement, cubic cm (valves per cylinder)	1197	1390	1390	1390	1598
Max. power ¹ , PS at rpm	86/4800	122/5000	122/5000	122/5000	105/4400
Max. torque, Nm at rpm	160/1500-3500	200/1500-4000	200 / 1500-4000	200 / 1500-4000	250/1500-2500
0-62mph acceleration, seconds	11.7	TBC	8.9	8.9	10.5
Top speed ² , mph	112	TBC	126	126	118
CO ₂ emissions ³ , g/km	118	TBC	119	122	105
Benefit in kind (BIK)%	10%	TBC	10%	15%	13%
Fuel consumption, mpg (l/100km) Urban	45.6 (6.2)	TBC	43.5 (6.5)	43.5 (6.5)	60.1 (4.7)
Fuel consumption, mpg (l/100km) Extra Urban	64.2 (4.4)	TBC	64.2 (4.4)	61.4 (4.6)	78.5 (3.6)
Fuel consumption, mpg (l/100km) Combined	55.4 (5.1)	TBC	54.3 (5.2)	53.3 (5.3)	70.6 (4.0)
ABI insurance group 1-20/1-50 ⁴	TBC	TBC	TBC	TBC	TBC
Unladen weight ⁴ , kg	1040	TBC	1125	1125	1140
Gross weight limit, kg	1490	TBC	1575	1575	1590
Roof load limit/nose weight, kg	75	75	75	75	75
Max trailer load unbraked ⁵ , kg	550	TBC	600	600	600
Max trailer load with 12% gradient ⁵ , kg	1000	TBC	1200	1200	1200
Max trailer load with 8% gradient ⁵ , kg	1200	TBC	1200	1200	1200
Luggage compartment capacity, rear seats upright, litres	270	270	270	270	270
Luggage compartment capacity, rear seats folded, litres	920	920	920	920	920
Fuel tank capacity approx, litres	45	45	45	45	45

Preliminary technical data is shown here as a guide and is subject to change.

⁴Highest insurance group rating shown. Group may be lower dependent on trim level. Please visit www.thatcham.org/abigrouprating for details.

Please note: The maximum power output figures are quoted in PS (or Pferdestärke, which is the metric equivalent of brake horsepower). To convert to brake horsepower, divide the PS figure by 1.0139.

¹The given value was obtained in accordance with the specified measurement procedure (the respective current version of the Directive 80/1269/EEC).

²Top speed is achieved in top gear.

³The given values were calculated in accordance with the specified measurement procedure (the respective current version of Directive 80/1268/EEC). This information does not relate to a single vehicle and does not comprise part of the offer but is merely intended for the purpose of comparison between the different vehicle types.

⁴Vehicle's unladen weight without driver (calculated in accordance with the current version of Directive 80/1268/EEC). The fitting of additional equipment may increase the vehicle's unladen weight and drag coefficient, whereupon the potential carrying capacity and top speed will be correspondingly reduced.

⁵The engine's power output always goes down with increasing altitude. At 1,000m above sea level, and for every additional 1,000m, deduct 10% from the weight of the outfit (trailer load limit + gross weight of the towing vehicle).





A1 dimensions

The technical drawings opposite show the exact dimensions of the A1, so you can check everything – from whether the car will fit in your garage to whether your luggage will fit in the boot.

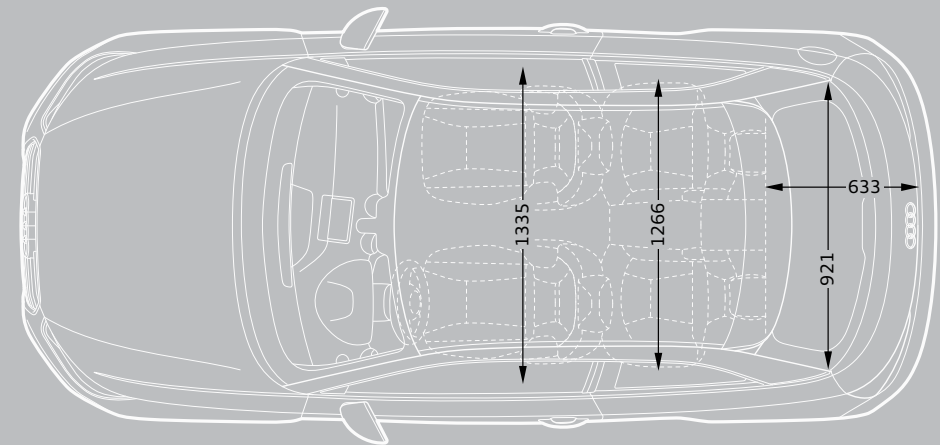
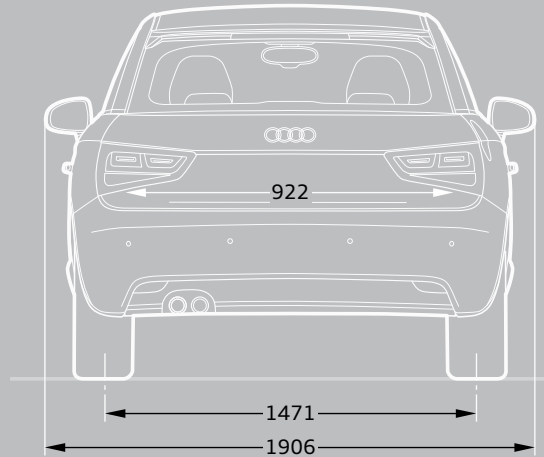
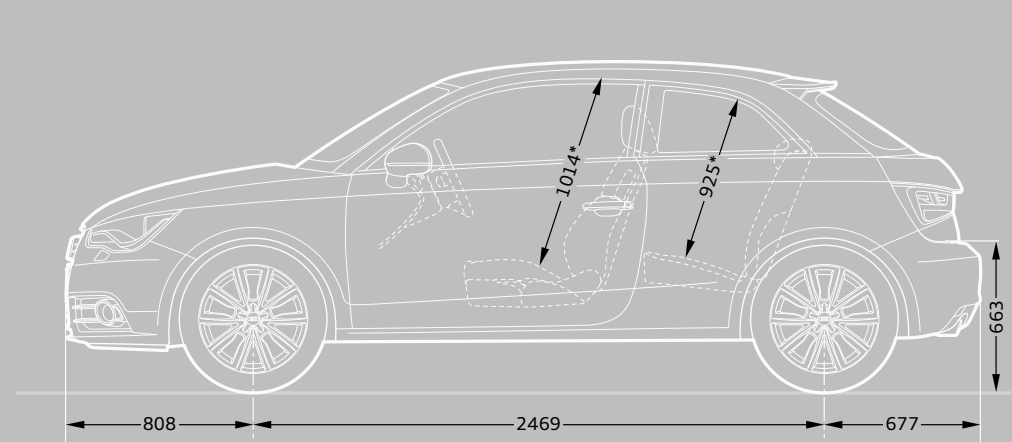
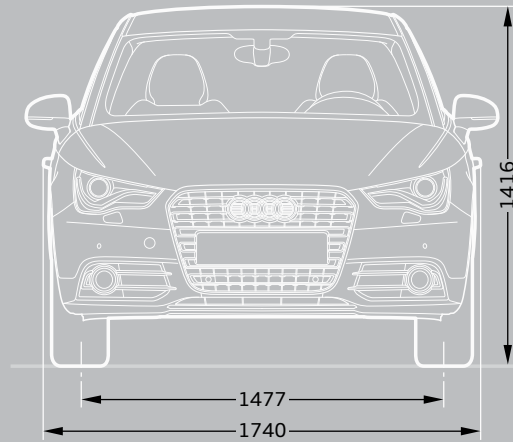

Dimensions were measured with vehicle at unladen weight.

Turning circle approx 10.7m.

Dimensions in millimetres.

*Maximum headroom.

Additional information

CO₂ data and information

CO₂ emissions-based Vehicle Excise Duty

Vehicle Excise Duty (Road Fund Licence) is based upon the amount of Carbon Dioxide (CO₂) a vehicle emits, measured in grams per kilometre (g/km). The DVLA has created thirteen categories:

Petrol and Diesel engines

A - up to 100g/km	£0.00
B - 101 to 110g/km	£0.00
C - 111 to 120g/km	£0.00
D - 121 to 130g/km	£0.00
E - 131 to 140g/km	£110.00
F - 141 to 150g/km	£125.00
G - 151 to 165g/km	£155.00
H - 166 to 175g/km	£250.00
I - 176 to 185g/km	£300.00
J - 186 to 200g/km	£425.00
K - 201 to 225g/km	£550.00
L - 226 to 255g/km	£750.00
M - over 255g/km	£950.00

Vehicle Excise Duty (VED) rates correct at time of going to print, but these may alter to reflect any change in the applicable VED rate

Servicing tailored to your needs

Regular servicing is key to safeguarding your Audi's performance and a full Audi service history could help you preserve the future re-sale value. To make servicing easy, the Audi Service Schedules have been designed to work with your individual driving style and vehicle.

There are two schedules available and your Audi Centre will advise which schedule is most suited to your needs. The conventional fixed Audi Inspection Service schedule has fixed intervals for the Oil-change and Inspection Service that are based on time

and distance, whichever comes first. With the Audi LongLife Service schedule, sensors take account of driving style and conditions in which the vehicle is used to indicate when the Oil-change Service is required. Oil-change Service intervals are therefore variable and are conveniently indicated via the on-board service interval display.

Fixed Inspection Service Schedule

	Vehicle usage:
Mileage	Less than 10,000 miles per annum
Type of journey	Mainly city/town centre driving. Short journeys
Conditions	Frequent cold starts. High engine loading – e.g. frequent hill climbs, vehicle fully loaded, towing
Driving style	Uneconomical – e.g. heavy acceleration, heavy braking, constant changes in speed, constant use of high revs, 'sporty' driving
	Service Intervals:
Oil-change Service	Fixed to every 9,000* miles/1 year
Inspection Service	Fixed to every 19,000* miles/2 years

Variable LongLife Service Schedule

	Vehicle usage:
Mileage	More than 10,000 miles per annum
Type of journey	Motorway and main road driving. Mainly longer distance journeys. Constant speeds
Conditions	Normal engine loading – e.g. with little or no towing, with little or no hill climbs. Normal vehicle loading
Driving style	Moderate acceleration, moderate braking, engine revs mainly below 3,000
	Service Intervals:
Oil-change Service	Variable to a maximum of every 19,000* miles/2 years
Inspection Service	Fixed to every 19,000* miles/2 years

*As indicated by the service interval display. Mileages are approximate as the Service Indicator system uses kilometres as its distance measurement.

Additional information

Welcome to Audi

By placing an order for your Audi, you're choosing to get behind the wheel of one of the most sophisticated cars on the road. And because we believe the service we offer should be just as advanced, we wanted to let you know exactly what you can expect from us, now and in the future.

We've agreed a set of standards with all our Centres, which governs the way we do business with you. It outlines the kind of service we promise to deliver for every customer, right down to filling each new Audi we sell with half a tank of fuel.

So whether you're interested in the date your car will arrive in the UK or the way we'll dispose of non-biodegradable materials after we service your Audi, you can have total confidence in us.

Audi Promise

Audi Centres

We guarantee that all of our Centres will be open as follows:

Sales: Monday to Friday 9am–6pm
Saturday 9am–5pm

Service: Monday to Friday 8am–6pm
Saturday 8.30am–1pm

Sunday opening is at local discretion.

New car delivery

Once we've confirmed a delivery date for your car, we'll keep you informed of progress. Subject to reasonable notice, we'll then deliver it to a place of your choice, whether that's your home or place of work. In the unlikely event of a delay, we'll provide a courtesy car to minimise inconvenience and keep you mobile.

The experts in Vorsprung durch Technik

Would you entrust your Audi to anyone who hasn't been regularly trained to Audi standards? Our network of Audi Approved Master Technicians have undergone an impressive 100,000 hours of training over a 10-year programme to ensure they have the latest technical expertise for maintaining and servicing your Audi. All of our Service Advisors undergo a specialist induction and training to ensure they are Audi professionals and able to talk to you about any issues you may have with your Audi vehicle. What's more, we have so much expertise and experience in looking after Audi vehicles that we are able to make a note of your mileage and the state of your vehicle as and when we see it and predict when certain key events may occur. As part of our commitment to you, we will notify you in plenty of time so you can make an appointment with us.

Your convenience comes first

At Audi you can choose from a range of convenient services that suit your needs. Why not book a 'service while you wait' appointment* and enjoy our complimentary refreshments while your car is with us? Or, if you need to be mobile, take advantage of one of our courtesy cars which we can even collect and deliver to you.* We guarantee we can service your Audi within 5 days without a courtesy car, or within 10 days if you need transport. We will also ensure your car is returned to you with a full valet.

Audi Genuine Parts

Would you put a part into your Audi that wasn't the same quality as the factory fitted original? You can rest assured that only Audi Genuine Parts will be used on your vehicle. What's more, Audi parts and labour come with a 2-year guarantee.** We stock a wide variety of parts, so we are well covered. However, if we don't have a part in stock at our Centre we have the back-up of parts at other Audi Centres, at our national warehouse and our factory and can usually source the relevant part very quickly.

We don't like surprises either

We believe strongly in transparency and there will be no hidden costs. For added peace of mind, we will give you a quotation over the phone for the work you have requested and email you the price confirmation. We'll consult you if any additional work on your car is needed when it is with us. We won't carry out any extra work without asking your permission first.

The Audi Stamp

Regular servicing is key to safeguarding your Audi's performance and a full Audi service history could help you preserve the future re-sale value of your car. Only the Audi Stamp will prove your approved Audi service history.

Getting better every time

We continually gather feedback from our Audi Trained Technicians, as well as our customers, to ensure our vehicles are running as they should. Whenever we see an Audi for a service, we connect it directly to our headquarters in Ingolstadt which enables us to check your car's software and make sure it's as up-to-date as possible. If the factory has released a software upgrade for your model, it can be applied immediately – improving anything from your car's efficiency to the precision of its parking system.

Environmental commitment

We promise to dispose of all non-biodegradable materials from your vehicle in a responsible manner.

*Subject to availability.

**Excludes wear and tear.

Pricing information

Pricing

Prices and specifications given are correct at the time of printing. Always check details with your Audi Centre, as Audi policies are continually developing. We reserve the right to change prices or specifications at any time.

All prices are subject to VAT, currently charged at 17.5%, but this may alter to reflect any change in the applicable VAT rate.

Delivery charges and number plates are not included in the vehicle price.

Delivery charge	£473.62
Number plate	£20.00
VAT	£86.38
Total	£580.00

Audi Roadside Assistance

Your new car comes complete with 3 years' complimentary roadside assistance and recovery across the UK provided by RAC Motoring Services. Also included is roadside assistance throughout Europe, managed by RAC Motoring Services.

For further information and terms and conditions, please visit audi.co.uk

Audi Customer Care

Every new Audi benefits from the comprehensive Audi Customer Care Package, which comprises:

- ▶ A 3-year Audi warranty, which covers you for unlimited mileage in the first 2 years of ownership, with a full mechanical and electrical warranty which covers you for up to 60,000 miles in the 3rd year

- ▶ A 3-year paint warranty
- ▶ A 12-year anti-corrosion warranty
- ▶ 3 years' UK roadside assistance and recovery

You also have the option when ordering your new car of choosing a four-year or five-year Audi warranty. Speak to a member of the sales team for more information.

Audi Tax-Free Sales

If you are entitled to purchase a vehicle free of VAT, normally through Military or Diplomatic privilege, please contact your local Audi Centre for full details.

Should you have any difficulty obtaining the information you require, please call Freephone 0800 585878.

Audi Finance

Audi Finance specialise in providing funding solutions for Audi drivers. Whether your Audi is for private or business use, there are a range of funding options to choose from

Below is the full range of finance products.

- ▶ Solutions – a Personal Contract Plan
- ▶ Hire purchase
- ▶ Lease purchase
- ▶ Finance lease
- ▶ Contract hire

With all products, you can choose a fixed-cost maintenance plan designed to help you budget accurately.

No matter what Audi model you choose, your local Audi Centre can provide you with a personalised quote which could fit your budget and motoring needs.

Audi Finance is a trading name of Volkswagen Financial Services (UK) Limited. An offer of finance depends on certain conditions. Available to people over 18 in the UK only.

Audi Insurance

We want you to start enjoying your new car from day one and thanks to Audi Insurance complimentary seven day cover, you can. Call free on 0800 316 7893 (lines are open Monday to Friday 8am - 9pm, and Saturday 9am - 5pm), provide a few details and a cover note will be sent to your Audi Centre. They will then tax your car and you can drive it away.

Audi Insurance is a trading name of Volkswagen Insurance Service (Great Britain) Limited, an appointed representative of Volkswagen Financial Services (UK) Limited, Brunswick Court, Yeomans Drive, Blakelands, Milton Keynes MK14 5LR. Registered in England number 2835230. Audi Insurance is sold, underwritten and administered by Allianz Insurance plc registered in England number 84638. Registered office 57 Ladymead, Guildford, Surrey GU1 1DB. Volkswagen Financial Services (UK) Limited and Allianz Insurance plc are authorised and regulated by the Financial Services Authority. Volkswagen Financial Services (UK) Limited and Allianz Insurance plc are not part of the same corporate group.

Audi UK

Customer Services
Selectapost 29
Sheffield
S97 3FG
0800 699888
audi.co.uk

Specifications and prices subject
to change without notice.

© Audi (UK)

Printed in the UK
Edition 1.1 06/10
2011 Model Year

Images are for illustrative purposes only. Models shown are left hand drive.



Mixed Sources
Product group from well-managed
forests and other controlled sources

Cert no. TF-COC-002327
www.fsc.org
© 1996 Forest Stewardship Council