



**The Audi Q5**

Pricing and Specification Guide  
Valid from December 2009

# Personalising your Audi Q5

This guide has been designed to help you tailor and price your Audi Q5 quickly and logically. At the back of this guide, you will also find information on CO2 emissions-based vehicle excise duty and other services offered by Audi, including Finance and Insurance. Alternatively, you can go to [audi.co.uk](http://audi.co.uk) and configure your Audi Q5 online.

## The Audi Q5

Efficiency	8
Engines	10
Transmission	11
quattro®	12

## Model details and prices

Standard model equipment	14
SE model equipment	15
S line model equipment	16
S line Special Edition model equipment	17
Model prices	18

<b>Audi exclusive</b>	20
-----------------------	----

## Colour and upholstery

Paint	24
Upholstery	26
Colour and trim guide	30
Inlays	34

## Options

Wheels, tyres and suspension	36
Packages	38
Audio and communication	40
Interior equipment	42
Seats	44
Exterior equipment	45
Warranty extensions	45
Safety and security	46
Steering wheels	48
Off-road capabilities	49
Merchandise	50
Accessories	51

## Technical details

Technical data	52
Dimensions	54
Additional information	55
Pricing information	57





## Vorsprung durch Technik

Three words that express the very essence of Audi. Vorsprung durch Technik isn't a slogan. It's our way of seeing the world. It is the driving force behind our history of innovation that continues into the 21st century. Indeed, many technologies that Audi pioneered remain in our cars today. Some are milestones in the history of the motorcar.

From our beginnings in 1899, to the Auto Union team's Grand Prix successes in the 1930s and our more recent wins at Le Mans, we have always been at the forefront of the motor industry.

Vorsprung durch Technik makes us who we are. To see more of its influence, just read on.

## The streamlined Audi Q5

The Audi Q5 is no typical SUV, combining the poise and athleticism of a coupé with the practicality and space of a much larger car. It also offers the exceptional grip of quattro® all-wheel-drive, 17-inch alloy wheels and some other advanced features you might not expect. There's a choice of direct-injection TDI® and FSI® engines, a five-link front suspension and an optional S tronic® transmission – ensuring that the Audi Q5 delivers all the handling and performance its coupé-like shape suggests.





## Efficiency

At Audi, doing less is something we're trying to do more of. We're working to use less fuel, release less CO<sub>2</sub> and waste less energy. It's why we've incorporated a number of more efficient technologies into the Audi Q5.

## Recuperation

When a vehicle brakes, the discs convert the kinetic energy into thermal energy, which is wasted as it cannot be used. With a recuperation system, like the one in the Audi Q5, the kinetic energy is converted into useful electrical energy. The way it works is simple. While the car is coasting or braking, the alternator voltage is raised above the level of the basic electrical system, which enables the alternator to generate electrical energy and store it temporarily in the battery. When the vehicle accelerates, this energy is used to relieve the load on the alternator, resulting in a fuel saving of up to 3%.





### **Aerodynamics**

A car's shape can have a big impact on its efficiency. It's why we've worked to make the Audi Q5 as aerodynamic as possible.



## Engines

### Petrol

FSI® direct-injection technology is a unique Audi innovation that was originally developed for the Le Mans 24-hour endurance race to deliver more power and torque, as well as enhanced fuel efficiency. Precisely the right amount of fuel and air are injected into the combustion chambers, enabling the engine to 'breathe' more easily. It results in reduced heat loss and increased output, with around a 15% reduction in fuel consumption and significantly lower exhaust emissions. We've also developed TFSI®, with turbocharging, which combines FSI® technology with forced induction – giving cars an extra injection of power.

### Diesel

We introduced TDI® to the roads in 1989, marking a departure from the noisy, fuel-thirsty diesel engines of the past. And since then, we've continuously refined it, recently developing common-rail technology. Under this system, a series of piezo injectors use electrical charge to precisely control the amount of fuel injected into the engine. As well as reducing noise, this allows combustion to happen at a lower temperature, with less oxygen, which cuts down emissions.





## Transmission

### **S tronic®**

Driving is all about thinking ahead, which is just what the S tronic® dual-clutch transmission does. It works almost as two separate systems, one engaging the odd-numbered and the other the even-numbered gears. So when you're accelerating in second, it has third gear waiting for you. And once you make the switch, it's already thinking about fourth. With two clutches working together, you can change gears almost instantly while experiencing smooth, uninterrupted power.

## quattro®

It's the technology that's given us the edge on the rally circuit ever since it was first introduced over 25 years ago, bringing victory for the Audi quattro® on its very first outing. It's called quattro® permanent all-wheel-drive. In this system, four permanently driven wheels deliver better acceleration, road-holding and safety, while asymmetric dynamic torque distribution intelligently controls the flow of power to the front and rear axles.

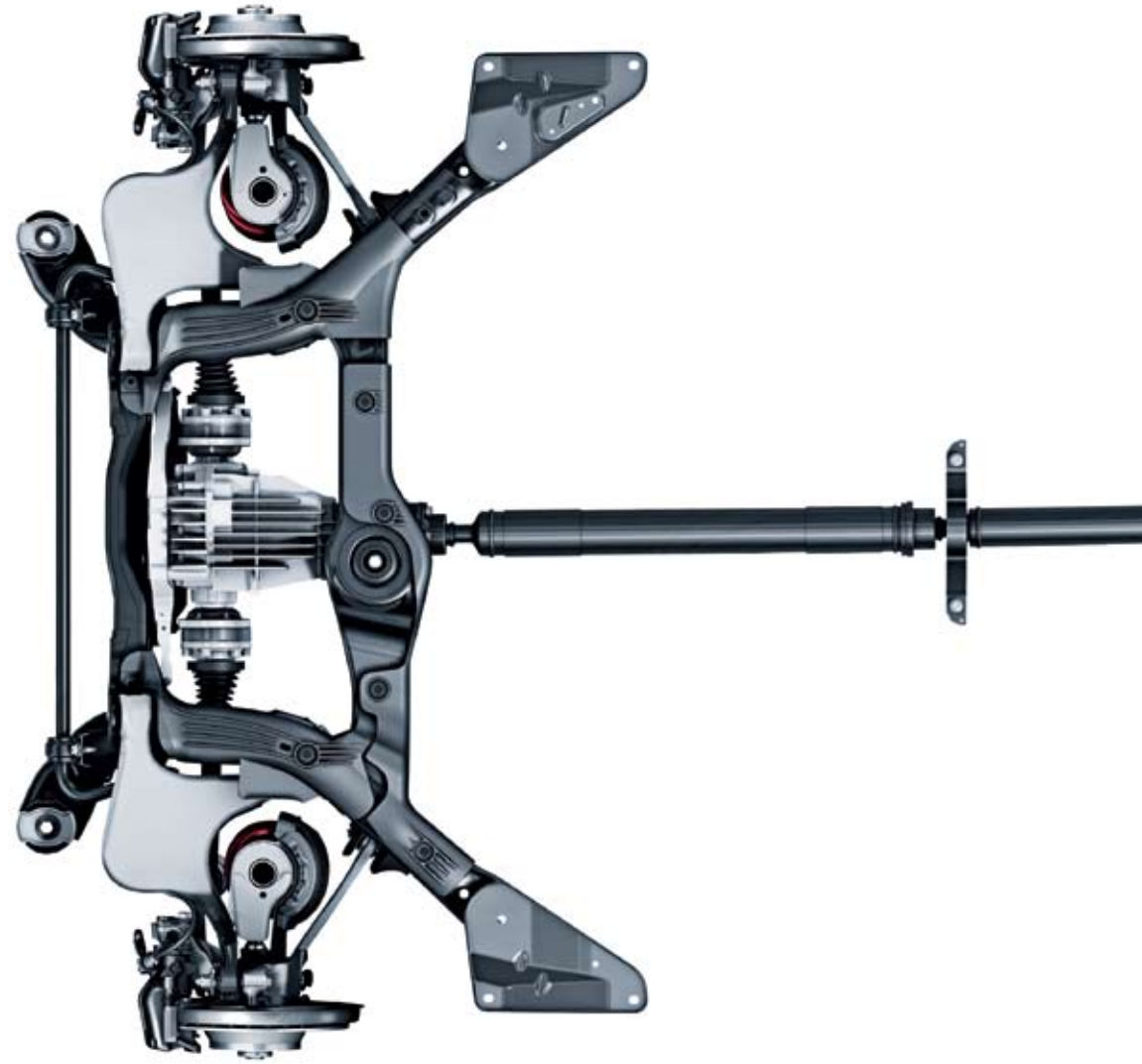

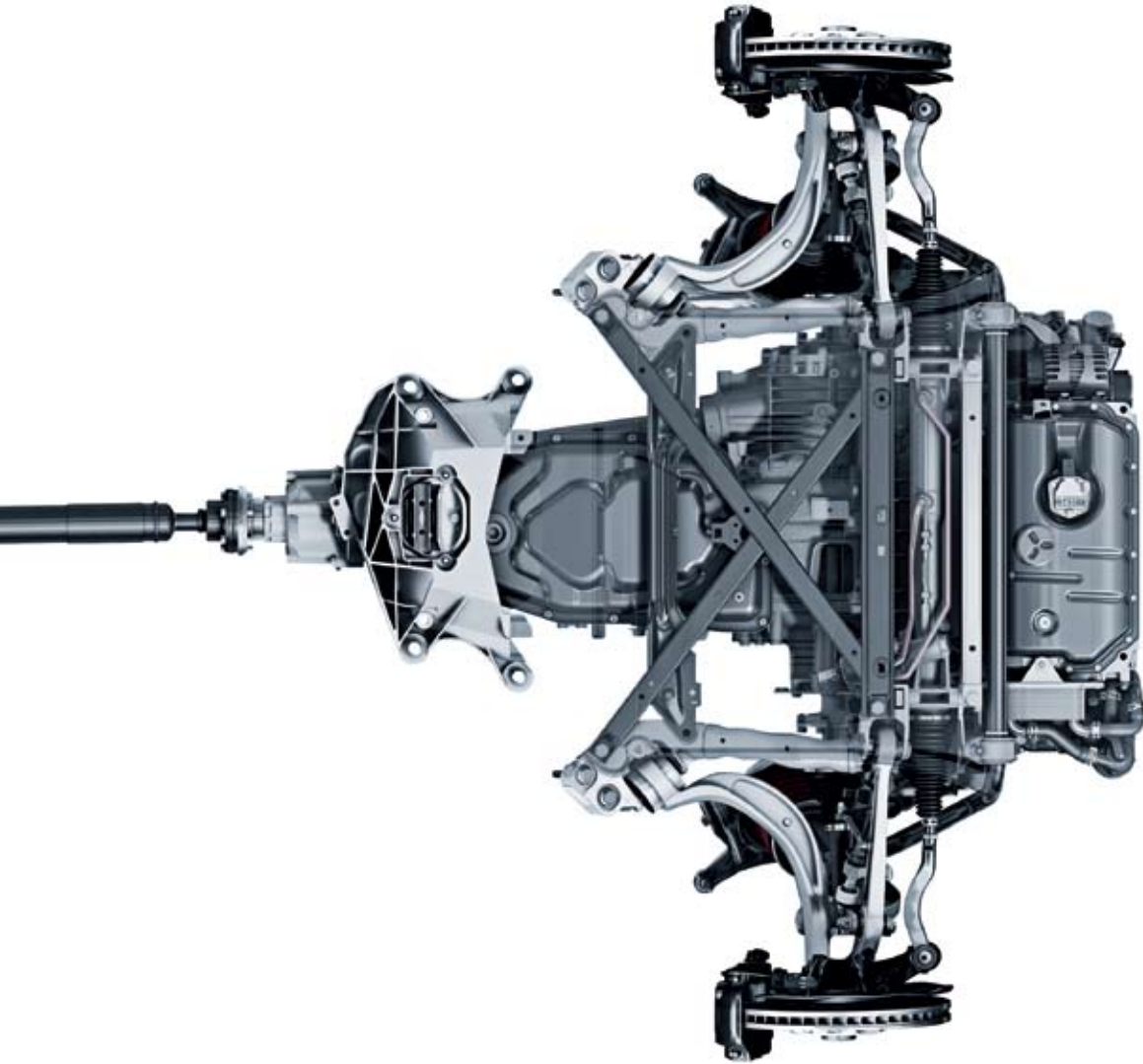

It means that the Audi Q5 can 'read' the road, sensing changes in the surface beneath the wheels and adjusting their grip accordingly. So when conditions get a little more demanding – in particular, when you go off-road – quattro® adapts, putting all the force of the Audi Q5's engine precisely where it's needed to handle the change in terrain.

# Standard model equipment

All Audi Q5 models have the following items of standard equipment

## Wheels, tyres and suspension

17" x 8J '6-spoke' design alloy wheels with 235/65 R17 tyres

Tyre mobility system

Servotronic speed-related power-assisted steering

## Audio and communication

6 speakers (80 Watts)

Audi Concert radio – CD player with MP3 compatibility, 6.5" colour centre console screen, including AUX-IN socket

Multi Media Interface

## Interior equipment

1-zone climate control

4-spoke leather steering wheel

Driver's Information System (DIS) – red and black

Front and rear electric windows

Front and rear floor mats

Micrometallic inlays

## Safety and security

Anti-theft device – Thatcham category 1 approved

Electromechanical parking brake

First-aid kit

Front and rear fog lights

Front and rear ISOFIX seats with airbag de-activation switch for front passenger seat

Halogen headlights with daytime-running lights

Hill descent assist (please see page 49 for further information) with off-road Electronic Stability Programme (ESP)

Side airbags for driver and front passenger seats

Tool kit and car jack

Warning triangle

## Seats

3-point seat belt with belt-force limiters for all 5 seats

Split-folding rear seat

Steppe cloth upholstery

## Exterior equipment

Aluminium roof rails with roof bar detection (automatically adjusts the ESP to react to the higher centre of gravity when roof bars are in place)

Black exterior window trims

Contrasting bumpers

Door mirrors – electrically adjustable and heated

Stone grey finish grille

Rear spoiler

Roof bars



17" '6-spoke' design alloy wheels



Halogen headlights with daytime-running lights



Door mirrors – electrically adjustable and heated



Front and rear fog lights

# SE model equipment

## In addition to Standard model equipment

**Basic RRP**  
£1,957.45

**Total RRP inc VAT**  
£2,300.00

### Wheels, tyres and suspension

18" x 8J '10-spoke V' design alloy wheels with 235/60 R18 tyres and locking wheel bolts

### Audio and communication

Audi sound system – 10 high-performance loud speakers (180 Watts) and 6-channel amplifier

### Seats

Milano leather upholstery

### Interior equipment

4-spoke multi-function leather steering wheel

Aluminium silver inlays

Colour Driver's Information System (DIS)

Deluxe 3-zone climate control with separate air distribution and digital temperature displays for driver, front passenger and rear passenger compartment (3.0 TDI® and 3.2 FSI® only)

Front centre armrest including 12-Volt socket

### Exterior equipment

Aluminium window trims framing the exterior side windows

Chrome-plated exhaust tailpipe surrounds (3.0 TDI® and 3.2 FSI® only)

Full body-coloured bumpers

High-gloss painted grille on 3.0 TDI® and 3.2 FSI®. All other models come with stone grey finish grille

### Safety and security

Auto-dimming rear-view mirror

Automatic headlight operation

Automatic windscreen wiper operation

Rear acoustic parking system



18" x 8J '10-spoke V' design alloy wheels



Aluminium silver inlays



Driver's Information System (DIS)

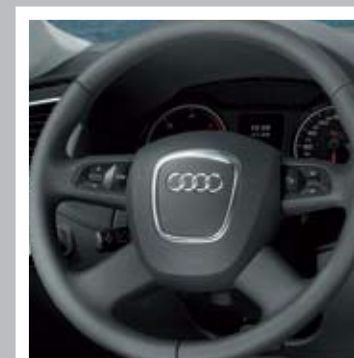

4-spoke multi-function leather steering wheel

# S line model equipment

## In addition to SE model equipment

### Basic RRP

£1,829.79

### Total RRP inc VAT

£2,150.00

### Wheels, tyres and suspension

19" x 8J '5-spoke' design alloy wheels with 235/55 R19 tyres and locking wheel bolts  
S line Sports suspension (not lowered)

### Seats

Front Sports seats in Milano leather with electric lumbar support (S line embossed)

### Interior equipment

Black headlining  
Matt-brushed aluminium inlays  
S line 3-spoke leather multi-function steering wheel (with gear-shift paddles for S tronic®)  
S line sill plates and aluminium loading strip for the boot

### Exterior equipment

Chrome fog light surround  
Chrome-plated exhaust tailpipe surrounds (2.0 TFSI and 2.0 TDI only)  
Diffuser in Platinum grey optic  
Rear LED lights  
S line exterior styling package including:

- S line badges on front wings
- S line front bumper
- S line rear diffuser
- S line side skirts
- S line grille with chrome vertical bars

Xenon headlights with automatic headlight-range adjustment, headlight washers and LED daytime-running lights



19" x 8J '5-spoke' design alloy wheels (PQR)



S line 3-spoke leather multi-function steering wheel

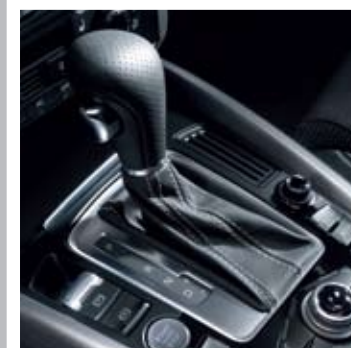

Matt-brushed aluminium inlays



Chrome-plated exhaust tailpipe surrounds

## S line Special Edition model equipment

### In addition to S line model equipment

**Basic RRP**

£1,063.83

**Total RRP inc VAT**

£1,250.00

Valid for new vehicle orders placed up to and including 30 June 2010 and delivered on or after 1 March 2010 only. Subject to availability.

**Wheels, tyres and suspension**

20" x 8.5J '5-double-spoke off-road' design alloy wheels with 255/45 R20 tyres

**Seats**

Front Sports seats in Milano leather with electric lumbar support (S line embossed)

**Interior equipment**

Bluetooth interface

Bang & Olufsen sound system

DAB radio

**Exterior equipment**

Electric tailgate



20" x 8.5J '5-double-spoke off-road' design alloy wheels



Bang & Olufsen sound system



Mobile telephone preparation - Low



## Audi Q5 Standard

Engines	Power	Transmissions	Basic RRP	Total RRP inc VAT	Recommended OTR
2.0 TFSI quattro	180PS	6-speed manual	£21,914.89	£25,750.00	£26,600.00
2.0 TFSI quattro	211PS	6-speed manual	£23,106.38	£27,150.00	£28,000.00
2.0 TDI quattro	143PS	6-speed manual	£22,170.21	£26,050.00	£26,860.00
2.0 TDI quattro	170PS	6-speed manual	£23,106.38	£27,150.00	£27,960.00

## Audi Q5 SE

Engines	Power	Transmissions	Basic RRP	Total RRP inc VAT	Recommended OTR
2.0 TFSI quattro	180PS	6-speed manual	£23,872.34	£28,050.00	£28,900.00
2.0 TFSI quattro	211PS	6-speed manual	£25,063.83	£29,450.00	£30,300.00
3.2 FSI quattro	270PS	7-speed S tronic	£29,234.04	£34,350.00	£35,200.00
2.0 TDI quattro	143PS	6-speed manual	£24,127.66	£28,350.00	£29,160.00
2.0 TDI quattro	170PS	6-speed manual	£25,063.83	£29,450.00	£30,260.00
3.0 TDI quattro	240PS	7-speed S tronic	£29,659.57	£34,850.00	£35,700.00

## Audi Q5 S line

Engines	Power	Transmissions	Basic RRP	Total RRP inc VAT	Recommended OTR
2.0 TFSI quattro	180PS	6-speed manual	£25,702.13	£30,200.00	£31,050.00
2.0 TFSI quattro	211PS	6-speed manual	£26,893.62	£31,600.00	£32,450.00
3.2 FSI quattro	270PS	7-speed S tronic	£31,063.83	£36,500.00	£37,350.00
2.0 TDI quattro	143PS	6-speed manual	£25,957.45	£30,500.00	£31,310.00
2.0 TDI quattro	170PS	6-speed manual	£26,893.62	£31,600.00	£32,410.00
3.0 TDI quattro	240PS	7-speed S tronic	£31,489.36	£37,000.00	£37,850.00

**Please note:** The maximum power output figures are quoted in PS (or Pferdestärke, which is the metric equivalent of brake horsepower). To convert to brake horsepower, divide the PS figure by 1.0139.

**Recommended On-The-Road (OTR) retail prices include:** delivery charge, half a tank of fuel, number plates at £580.00 (inc. VAT), Road Fund Licence (which may vary depending on model/transmission – see page 55 for details) and first registration fee at £55.00.

RRP – Recommended Retail Price. VAT is calculated at 17.5% but this may alter to reflect any change in the applicable VAT rate.

## Audi Q5 S line Special Edition

Engines	Power	Transmissions	Basic RRP	Total RRP inc VAT	Recommended OTR
2.0 TFSI quattro	180PS	6-speed manual	£26,765.96	£31,450.00	£32,300.00
2.0 TFSI quattro	211PS	6-speed manual	£27,957.45	£32,850.00	£33,700.00
3.2 FSI quattro	270PS	7-speed S tronic	£32,127.66	£37,750.00	£38,600.00
2.0 TDI quattro	143PS	6-speed manual	£27,021.28	£31,750.00	£32,560.00
2.0 TDI quattro	170PS	6-speed manual	£27,957.45	£32,850.00	£33,660.00
3.0 TDI quattro	240PS	7-speed S tronic	£32,553.19	£38,250.00	£39,100.00

## Transmissions

	7-speed S tronic
2.0 TFSI 211PS	•
3.2 FSI	S
2.0 TDI 170PS	•
3.0 TDI	S
<b>Basic RRP</b>	<b>£1,234.04</b>
<b>Total RRP inc VAT</b>	<b>£1,450.00</b>

– = Not available

• = Available

S = Standard



## Audi exclusive



## Audi exclusive

Every Audi is intrinsically exclusive. It's the breathtaking design, the exceptional engineering, the Vorsprung durch Technik. But for that special touch you can specify your new Audi Q5 with options from Audi exclusive. Whether you want a unique, custom-mixed paint colour or seats in a combination of complementary shades, Audi exclusive will enable you to drive the car you've always imagined.

Both the exclusive and standard options can be found on the following pages.

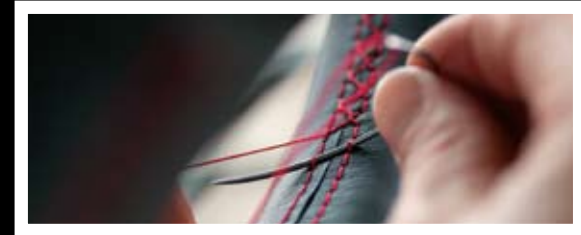

## Audi exclusive line





# Paint

You can select one of the standard colours shown opposite or, for a different look, choose from a range of optional finishes.

## Standard colours



Ibis white - T9

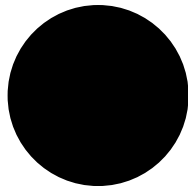

Brilliant black - A2

## Optional colours

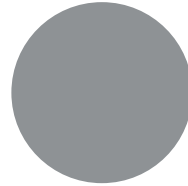

Ice silver, metallic - P5

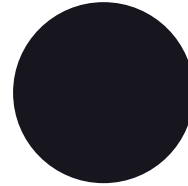

Tungsten grey, metallic - 1J

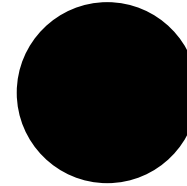

Phantom black, pearl effect - L8

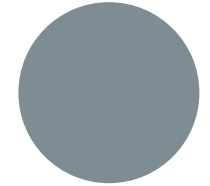

Quartz grey, metallic - Q4

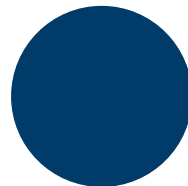

Stratos blue, pearl effect - X4

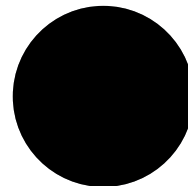

Lava grey, pearl effect - 1R

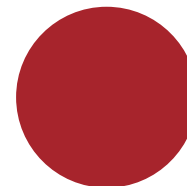

Garnet red, pearl effect - 9C

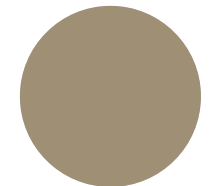

Dakar beige, metallic - 9X

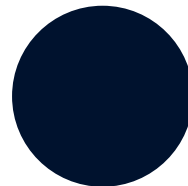

Deep sea blue, pearl effect - 8A

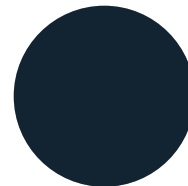

Meteor grey, pearl effect - X5

All the colour swatches on this page are matched as accurately as possible to the actual paint colours used. However, due to print processes, Audi UK cannot guarantee that colours shown are 100% accurate.

Visit your local Audi Centre for a more accurate colour swatch.

Options are subject to availability and may extend delivery.

RRP - Recommended Retail Price.

VAT is calculated at 17.5% but this may alter to reflect any change in the applicable VAT rate.

### Optional colours

**Basic RRP**

£510.64

**Total RRP inc VAT**

£600.00

## S line colours

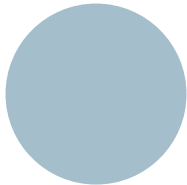

Monza silver, metallic - U7

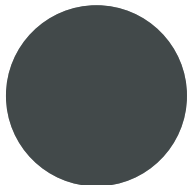

Daytona grey, pearl effect - 6Y

### S line colours

**Basic RRP**  
£510.64

**Total RRP inc VAT**  
£600.00

# Paint

## Audi exclusive

Everyone has a favourite colour. No matter what yours is, Audi exclusive provides a range of unique colours that have been designed to set your car apart. Choose from the swatches here, or specify any other paint colour in the Audi range - whether it's Jet blue from the Audi R8 or Alpine white from the original Audi quattro. The choice is yours.

## Customised

If you have a particular colour in mind, we'll mix the exact metallic or pearl-effect shade you want.\*

\*Custom paint is subject to factory approval, and is available for metallic and pearl-effect water-based paints only. Three-colour process colours and two-tone schemes are not available.

All the colour swatches on this page are matched as accurately as possible to the actual paint colours used. However, due to print processes, Audi UK cannot guarantee that colours shown are 100% accurate.

Visit your local Audi Centre for a more accurate colour swatch.

RRP - Recommended Retail Price.

VAT is calculated at 17.5% but this may alter to reflect any change in the applicable VAT rate.

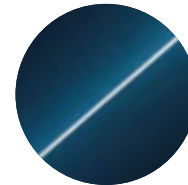

Palace blue, pearl effect

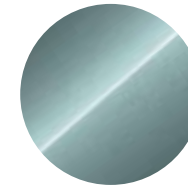

Morning dew, metallic

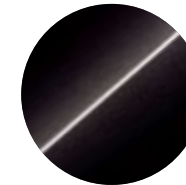

Saddle brown, pearl effect

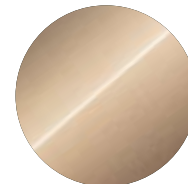

Sand beige, pearl effect

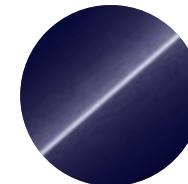

Velvet purple, pearl effect



Any colour in the Audi range

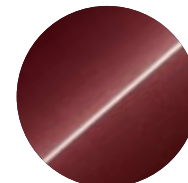

Classic red, pearl effect

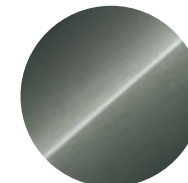

Oak green, metallic

### Audi exclusive

**Basic RRP**  
£1,446.81

**Total RRP inc VAT**  
£1,700.00



Customised paint

### Customised

**Basic RRP**  
£2,042.55

**Total RRP inc VAT**  
£2,400.00



# Upholstery

## Standard seats

Choose your favourite upholstery from the swatches shown opposite to give your car's interior the look and feel you want.









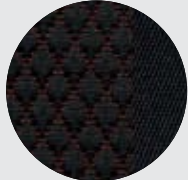

Please note: when ordering leather upholstery on standard cars, this must be combined with an upgraded inlay. When upgrading from Steppe cloth to Havanna cloth an upgraded inlay will be required at extra cost.

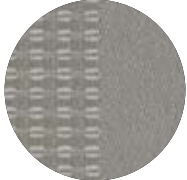
Options are subject to availability and may extend delivery.

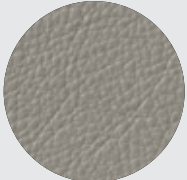
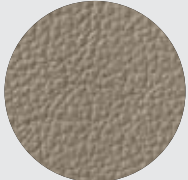
- = Not available  
• = Available  
S = Standard

RRP - Recommended Retail Price.

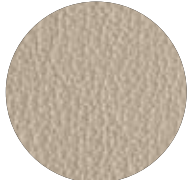





VAT is calculated at 17.5% but this may alter to reflect any change in the applicable VAT rate.

					Standard	SE	S line	S line Special Edition	Basic RRP	Total RRP inc VAT
Steppe cloth					S	-	-	-	No charge	No charge
	Black/Orange - RA	Light grey - RD								
Havanna cloth					•	-	-	-	£302.13	£355.00
	Black/Cinnamon - RB	Light grey - RD	Cardamom beige - RG							
Milano leather					•	S	-	-	£1,361.70	£1,600.00
	Black - CA	Light grey - RD	Cardamom beige - RG							
Fine Nappa leather					•	-	-	-	£1,702.13	£2,000.00
	Black - CA	Star silver - RC/RF	Cinnamon brown - RE							
					-	•	-	-	£340.43	£400.00
	Light grey - RD	Cardamom beige - RG								

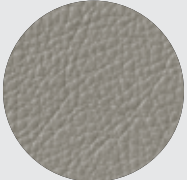
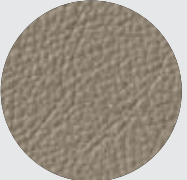
# Upholstery

## Sports seats

With electric lumbar support.

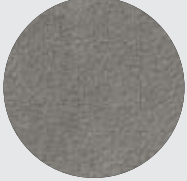
					Standard	SE	S line	S line Special Edition	Basic RRP	Total RRP inc VAT
Milano leather					•	-	-	-	£1,702.13	£2,000.00
	Black - CA	Light grey - RD	Cardamom beige - RG		-	•	-	-	£340.43	£400.00
Fine Nappa leather					•	-	-	-	£2,042.55	£2,400.00
	Black/Black - CA	Star silver/Black - ET/EW	Cinnamon/Black - EU		-	•	-	-	£680.85	£800.00
										
	Light grey/Black - EV	Cardamom beige/Pimento beige - EY								
Leather/Alcantara					•	-	-	-	£1,361.70	£1,600.00
	Black - CA	Pale grey - RD			-	•	-	-	No charge	No charge

Options are subject to availability and may extend delivery.



- = Not available
- = Available
- S = Standard

RRP - Recommended Retail Price.

VAT is calculated at 17.5% but this may alter to reflect any change in the applicable VAT rate.

# Upholstery

## S line Sports seats

	Standard	SE	S line	S line Special Edition	Basic RRP	Total RRP inc VAT
<b>Milano leather</b>  Black - QE	-	-	S	S	No charge	No charge
<b>Leather/Alcantara</b>  Black - QE      Black with Silver stitching - QF	-	-	•	•	No charge	No charge
<b>Fine Nappa leather</b>  Black - QE	-	-	•	•	£302.13	£355.00

Options are subject to availability and may extend delivery.

- = Not available
- = Available
- S = Standard

RRP - Recommended Retail Price.

VAT is calculated at 17.5% but this may alter to reflect any change in the applicable VAT rate.



# Colour and trim guide

## Interior trim colours

### Standard seats

To help you choose the right interior for your new Audi Q5, please use this guide, showing the carpet, dashboard and headlining colours that have been matched to your chosen upholstery.

Order code	Upholstery	Carpet	Dashboard (upper/lower)	Headlining	Steppe cloth (N2K)	Havanna cloth (PEA)	Milano leather (PEB)	Fine Nappa leather (PEC)
RA	Black/Orange	Black	Black	Light grey	●	–	–	–
CA	Black	Black	Black/Black	Light grey	–	–	●	●
RC	Star silver	Black	Black/Black	Light grey	–	–	–	●
RE	Cinnamon	Black	Black/Black	Light grey	–	–	–	●
RD	Light grey	Graphite grey	Graphite grey/Graphite grey	Light grey	●	●	●	●
RF	Star silver	Graphite grey	Graphite grey/Graphite grey	Light grey	–	–	–	●
RG	Cardamom beige	Pimento beige	Pimento beige/Pimento beige	Linen beige	–	●	●	●
RB	Black/Cinnamon	Black	Black/Black	Light grey	–	●	–	–

### Sport seats

Order code	Upholstery	Carpet	Dashboard (upper/lower)	Headlining	Leather/Alcantara (PED)	Milano leather (PEL)	Fine Nappa leather (PEE)
CA	Black	Black	Black/Black	Light grey	●	●	●
RD	Light grey	Graphite grey	Graphite grey/Graphite grey	Light grey	●	●	–
RG	Cardamom beige	Pimento beige	Pimento beige/Pimento beige	Linen beige	–	●	–
CQ	Star silver with Black stitching	Black	Black/Black	Light grey	–	–	●
EU	Cinnamon with Black stitching	Black	Black/Black	Light grey	–	–	●
CS	Light grey with Black stitching	Graphite grey	Graphite grey/Graphite grey	Light grey	–	–	●
CR	Star silver with Black stitching	Graphite grey	Graphite grey/Graphite grey	Light grey	–	–	●
EY	Cardamom beige with Pimento stitching	Pimento beige	Pimento beige/Pimento beige	Linen beige	–	–	●

Options are subject to availability and may extend delivery.

– = Not available  
● = Available  
S = Standard

RRP – Recommended Retail Price.

VAT is calculated at 17.5% but this may alter to reflect any change in the applicable VAT rate.

# Colour and trim guide

## Interior trim colours

### S line seats

Order code	Upholstery	Carpet	Dashboard (upper/lower)	Headlining	Leather/Alcantara (N7K)	Milano leather (N1Y)	Fine Nappa leather (NR2)
QE	Black with Black stitching	Black	Black/Black	Black	●	●	●
QF	Black with Silver stitching	Black	Black/Black	Black	●	-	-



Options are subject to availability and may extend delivery.

- = Not available  
 ● = Available  
 S = Standard

RRP – Recommended Retail Price.

VAT is calculated at 17.5% but this may alter to reflect any change in the applicable VAT rate.

# Upholstery

## Audi exclusive

With Audi exclusive, you can specify your seats in Fine Nappa leather, in an array of different colours shown to the right.

Select just one all-over shade for each seat, or customise each panel in two or more complementary colours from the distinctive Audi exclusive palette. You can even choose the colour of the decorative stitching – to match or contrast with your chosen upholstery – from this varied collection. Whatever combination you decide upon, we think you'll be extremely comfortable with the result.

Options are subject to availability and may extend delivery.

- = Not available  
• = Available  
S = Standard

All leather upholstery choices include seats, head restraints, door inserts and front centre armrest (if fitted) in leather.

\*Not available in Alcantara.

RRP – Recommended Retail Price.

VAT is calculated at 17.5% but this may alter to reflect any change in the applicable VAT rate.

Order Code		Standard	SE	S line	S line Special Edition	Basic RRP	Total RRP inc VAT
<b>PYA S3G</b>	<b>Audi exclusive leather package 1 in Fine Nappa leather</b> – front and back seat upholstery, head restraints, door trim inserts and front centre armrest (if ordered) are leather-covered and colour-coordinated with the option of contrasting stitching on seat side sections and head restraints	-	•	-	-	£1,740.43	£2,045.00
<b>PYG S3G</b>	<b>Audi exclusive leather package 1 in Fine Nappa leather</b> – as above with front Sports seats and electric lumbar support	-	•	-	-	£2,076.60	£2,440.00
<b>PS8 PYB S3G</b>	<b>Audi exclusive leather package 1 in Valcona leather with climate-controlled comfort seats</b> – front and back seat upholstery, head restraints, door trim inserts and front centre armrest (if ordered) are leather-covered and colour-coordinated with the option of contrasting stitching on seat side sections and head restraints	-	•	-	-	£1,740.43	£2,045.00
<b>PS8 PYB S3G</b>	<b>Audi exclusive leather package 1 in Valcona leather with climate-controlled comfort seats</b> – front and back seat upholstery, head restraints, door trim inserts and front centre armrest (if ordered) are leather-covered and colour-coordinated with the option of contrasting stitching on seat side sections and head restraints	-	•	-	-	£4,612.77	£5,420.00
<b>PYC S3G</b>	<b>Audi exclusive leather package 1 in leather/Alcantara</b> – front and back seat side trims, head restraints, door trim inserts and front centre armrest (if ordered) are covered in leather; seat centre sections are covered in Alcantara, and all are colour-coordinated with the option of contrasting stitching on seat side sections and head restraints	-	•	-	-	£2,076.60	£2,440.00
<b>PYC S3G</b>	<b>Audi exclusive leather package 1 in leather/Alcantara</b> – front and back seat side trims, head restraints, door trim inserts and front centre armrest (if ordered) are covered in leather; seat centre sections are covered in Alcantara, and all are colour-coordinated with the option of contrasting stitching on seat side sections and head restraints	-	-	•	•	£1,740.43	£2,045.00
<b>PYD S3G</b>	<b>Audi exclusive leather package 2 in Fine Nappa leather</b> – comprising leather package 1 plus: seat backrest covers in leather and door armrests in leather	-	•	-	-	£2,957.45	£3,475.00
<b>PYJ S3G</b>	<b>Audi exclusive leather package 2 in Fine Nappa leather</b> – as above with front Sports seats and electric lumbar support	-	•	-	-	£3,293.62	£3,870.00
<b>PYJ S3G</b>	<b>Audi exclusive leather package 2 in Fine Nappa leather</b> – as above with front Sports seats and electric lumbar support	-	-	•	•	£2,957.45	£3,475.00
<b>PS8 PYE S3G</b>	<b>Audi exclusive leather package 2 in Valcona leather</b> – comprising leather package 1 with climate-controlled comfort seats plus: seat backrest covers and door armrests in leather	-	•	•	•	£5,829.79	£6,850.00
<b>YSO S3G</b>	<b>Leather-covered dashboard with contrasting stitching.</b> Available in Chestnut brown, Palace blue, Saddle brown, Havana brown, Jet grey and Crimson red with the option of contrasting stitching	-	•	•	•	£714.89	£840.00

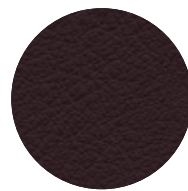

Chestnut brown

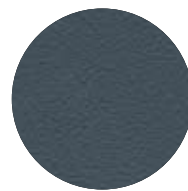

Jet grey\*



Alabaster white

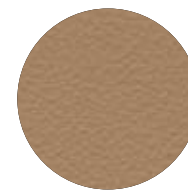

Sand beige

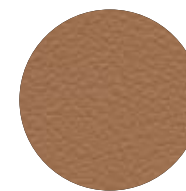

Cocos

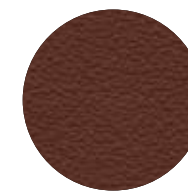

Saddle brown

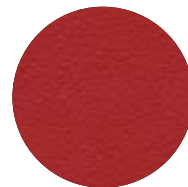

Crimson red\*

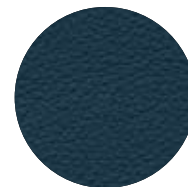

Palace blue



Magnolia



Havana brown

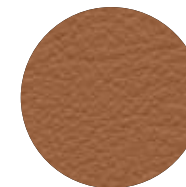

Cognac

# Upholstery

## Audi exclusive

Audi exclusive is ultimately about choice – but if you'd rather leave some of the decisions in the capable hands of our designers, the expert team at quattro GmbH have compiled Audi exclusive line, combining some of the most popular elements of the exclusive range in one, beautifully coordinated package.

Options are subject to availability and may extend delivery.

– = Not available  
• = Available  
S = Standard

RRP – Recommended Retail Price.

VAT is calculated at 17.5% but this may alter to reflect any change in the applicable VAT rate.

	Standard	SE	S line	S line Special Edition	Basic RRP	Total RRP inc VAT
<b>WQK Audi exclusive line</b>	–	•	–	–	£2,012.77	£2,365.00

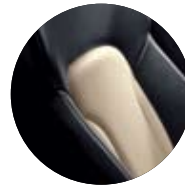

Magnolia – QQ



Alabaster white – UA

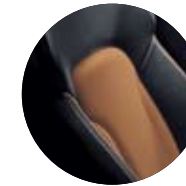

Cognac – QX

### This package includes

- ▶ Two-colour seat upholstery (black seat side sections, seat centre section in alabaster white, magnolia or cognac) in Fine Nappa leather
  - ▶ Seat side sections and head restraints with coloured piping (to match seat centre section)
  - ▶ Sports seats including electric lumbar support
  - ▶ Black interior including black add-on seat parts
  - ▶ Headlining in black cloth
  - ▶ Audi exclusive door sill trims, additional stainless steel loading lip cover
  - ▶ Leather-covered cockpit on driver's side in black with coloured stitching
  - ▶ Inlays in matt-brushed aluminium or walnut natural
  - ▶ Leather-covered Sports steering wheel in 3-spoke design with coloured stitching (to match seat centre section)
  - ▶ Gear lever gaiter with coloured stitching (to match seat centre section)
  - ▶ Armrest in door trims in leather with coloured stitching (to match seat centre section)
  - ▶ Floor mats with coloured piping (to match seat centre section)
- Can only be ordered in conjunction with rear bench seat (SKA)



# Inlays

Inlays are the all-important finishing touch that add flair and interest to your car's interior.

Order Code		Standard	SE	S line	S line Special Edition	Basic RRP	Total RRP inc VAT
<b>5MF</b>	<b>Aluminium silver</b>	●	S	-	-	£170.21	£200.00
<b>5TG</b>	<b>Matt-brushed aluminium</b>	-	-	S	S	No charge	No charge
<b>5TK</b>	<b>Ash, almond beige*</b>	●	●	-	-	£170.21	£200.00
<b>5TS</b>	<b>Walnut, natural*</b>	●	●	-	-	£170.21	£200.00
<b>7TL</b>	<b>Brown ash, natural*</b>	●	●	-	-	£170.21	£200.00
<b>5TL</b>	<b>Piano finish, black</b>	-	-	●	●	£255.32	£300.00

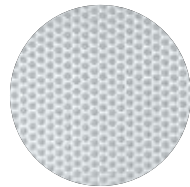

Aluminium silver – **5MF**



Matt-brushed aluminium – **5TG**



Ash, almond beige\* – **5TK**



Walnut, natural\* – **5TS**



Brown ash, natural\* – **7TL**

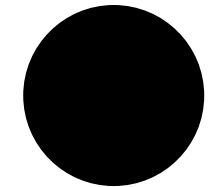

Piano finish, black – **5TL**

Options are subject to availability and may extend delivery.

- = Not available  
● = Available  
S = Standard

\*Must be combined with leather upholstery

RRP – Recommended Retail Price.

VAT is calculated at 17.5% but this may alter to reflect any change in the applicable VAT rate.

# Inlays

## Audi exclusive

Audi exclusive has sourced a wide range of materials which you can select for your inlays, from Sepia oak to rich quilted Maple wood.

Order Code		Standard	SE	S line	S line Special Edition	Basic RRP	Total RRP inc VAT
YTA S3G	Audi exclusive inlays	-	•	•	•	£740.43	£870.00



Fine grain maple, copper



Fine grain ash, nougat



Fine grain myrtle, nutmeg



Poplar, saffron

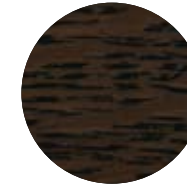

Oak, sepia

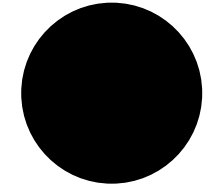

Piano finish, black

Options are subject to availability and may extend delivery.

- = Not available
- = Available
- S = Standard

RRP – Recommended Retail Price.

VAT is calculated at 17.5% but this may alter to reflect any change in the applicable VAT rate.

## Wheels, tyres and suspension

Choose a set of specially-selected alloy wheels to subtly enhance the way your car looks and drives. And you can also specify Audi drive select, which allows you to change suspension and steering settings according to your driving style.



18" x 8J '6-spoke Parabola' design  
alloy wheels - PRS



19" x 8J '5-arm' design  
alloy wheels - PRL



19" x 8J '10-spoke Star' design  
alloy wheels - PRT



20" x 8.5J '5-spoke Star' design  
alloy wheels\* - PRD



20" x 8.5J '5-double-spoke off-road' design  
alloy wheels\* - PQ7



20" x 8.5J '7-double-spoke' design  
alloy wheels\* - PQF

\*Please note: this option includes a small extension to the wheel arches.

On S line trims the wheel arch is matt black, while on SE models it matches the colour of the contrasting bumpers.

# Wheels, tyres and suspension

## Dynamic steering

With this new technology, driving is significantly more agile under everyday conditions, while directional stability and precision are increased at high speeds and in demanding driving situations.

## Damper control

Formed on the basis of lowered Sports suspension, the optional damper control system makes it possible to tune suspension settings individually for each wheel, using adjustable hydraulic dampers.

Options are subject to availability and may extend delivery.

– = Not available  
● = Available  
S = Standard

\*Please note: this option includes a small extension to the wheel arches.

On S line trims the wheel arch is matt black, while on SE models it matches the colour of the contrasting bumpers.

RRP – Recommended Retail Price.

VAT is calculated at 17.5% but this may alter to reflect any change in the applicable VAT rate.

Order Code		Standard	SE	S line	S line Special Edition	Basic RRP	Total RRP inc VAT
PRC	18" x 8J '10-spoke V' design alloy wheels with 235/60 R18 tyres	●	S	–	–	£425.53	£500.00
PRS	18" x 8J '6-spoke Parabola' design alloy wheels with 235/60 R18 tyres	●	–	–	–	£595.74	£700.00
		–	●	–	–	£170.21	£200.00
PRL	19" x 8J '5-arm' design alloy wheels with 235/55 R19 tyres	●	–	–	–	£851.06	£1,000.00
		–	●	–	–	£425.53	£500.00
PRT	19" x 8J '10-spoke Star' design alloy wheels with 235/55 R19 tyres	●	–	–	–	£936.17	£1,100.00
		–	●	–	–	£510.64	£600.00
PRD	20" x 8.5J '5-spoke Star' design alloy wheels with 255/45 R20 tyres* (not available in conjunction with off-road pack – VJ2)	●	–	–	–	£1,446.81	£1,700.00
		–	●	–	–	£1,021.28	£1,200.00
PQ7	20" x 8.5J '5-double-spoke off-road' design alloy wheels with 255/45 R20 tyres* (only available in conjunction with off-road pack – VJ2, except S line Special Edition)	●	●	–	S	£425.53	£500.00
PQF	20" x 8.5J '7-double-spoke' design polished alloy wheels with 255/45 R20 tyres* (not available in conjunction with off-road pack – VJ2)	●	–	–	–	£1,446.81	£1,700.00
		–	●	–	–	£1,021.28	£1,200.00
		–	–	●	–	£425.53	£500.00
PQS	20" x 8.5J '20-spoke' design two-piece alloy wheels with 255/45 R20 tyres* (not available in conjunction with off-road pack – VJ2)	●	–	–	–	£1,446.81	£1,700.00
		–	●	–	–	£1,021.28	£1,200.00
		–	–	●	–	£425.53	£500.00
2H1	Audi drive select (must be combined with dynamic steering and/or damper control)	–	●	●	●	£182.98	£215.00
1N7	Dynamic steering (must be combined with Audi drive select)	–	●	●	●	£604.26	£710.00
1BL	Damper control (must be combined with Audi drive select)	–	●	●	●	£565.96	£665.00
3F1	Collapsible spare wheel	●	●	●	●	£93.62	£110.00
7K6	Tyre pressure monitor display	●	●	●	●	£63.83	£75.00

# Packages

Some items work well together, which is why we've created these special packages. They provide increased convenience and value by combining several of our most popular options.

Order Code		Standard	SE	S line	S line Special Edition	Basic RRP	Total RRP inc VAT
<b>PNG 7X4 UF7</b>	<b>Technology package – High.</b> Satellite Navigation system – HDD-based with MMI 3G, Audi Music Interface and Audi parking system plus	-	●	●	●	£1,663.83	£1,955.00
<b>PNW 7X4 UF7</b>	<b>Technology package – Low.</b> Satellite Navigation system – DVD-based with Audi Music Interface and Audi parking system plus	-	●	●	●	£1,272.34	£1,495.00
<b>4E9 8T1 9ZX</b>	<b>Comfort package.</b> Cruise control, mobile telephone preparation – Bluetooth interface and power operated tailgate	-	●	●	-	£510.64	£600.00
<b>9VK QV3</b>	<b>Sound package.</b> Bang & Olufsen sound system and DAB digital radio	-	●	●	S	£510.64	£600.00

Options are subject to availability and may extend delivery.

- = Available
- = Not available
- S = Standard

RRP – Recommended Retail Price.

VAT is calculated at 17.5% but this may alter to reflect any change in the applicable VAT rate.

**Satellite Navigation system – DVD-based.** DVD-based route-planning and guidance with MMI control logic and 6.5" colour monitor, 3D map display, RDS radio, DVD-player for navigation system, audio or MP3 CDs. Includes European coverage disc

**Satellite Navigation system – HDD-based with MMI 3G.** 3rd generation of MMI including 2 FM tuners, high resolution (800x400) 7" colour TFT display, DVD movie-playing function, colour Driver's Information System, 2 SD card readers and 40GB hard drive – 10GB of which can be used to store up to 4,000 songs. HDD navigation functionality includes advanced speech recognition, 3D and topographical mapping display and advanced 3D building display



Mobile telephone preparation – Bluetooth interface



Bang & Olufsen sound system



# Audio and communication

Stay in touch using our range of communication functions, and give each journey its own soundtrack with our advanced audio equipment.

Options are subject to availability and may extend delivery.

- = Not available
- = Available
- S = Standard

RRP – Recommended Retail Price.

VAT is calculated at 17.5% but this may alter to reflect any change in the applicable VAT rate.

Order Code		Standard	SE	S line	S line Special Edition	Basic RRP	Total RRP inc VAT
<b>UF7</b>	<b>Audi Music Interface (AMI).</b> Universal connection for use with stereo audio sources, USB and MP3 devices including Apple iPod generation 4 onwards (iPod, iPod classic, iPod mini, iPod nano, iPod photo, iPod video, iPod touch). Provides intuitive control through the audio system and multi-function steering wheel (where fitted). It also replicates the iPod display on the audio screen and DIS, including track titles. The interface provides charging function (dependent on device). When AMI is ordered AUX-IN is deleted	•	•	•	•	£212.77	£250.00
<b>9VK</b>	<b>Bang &amp; Olufsen sound system.</b> Designed specifically for the Audi Q5, providing 5.1 surround-sound reproduction with dynamic compensation for road noise, 10-channel amplifier and 14 high-performance loudspeakers (total output 505 Watts)	•	-	-	-	£642.55	£755.00
<b>7D1</b>	<b>CD changer and DVD player.</b> 6-CD changer located in the glovebox and single CD/DVD slot in centre console. Only available with Satellite Navigation system – HDD-based	•	•	•	•	£302.13	£355.00
<b>8UM</b>	<b>Audi Symphony radio.</b> AM/FM twin tuner with TP memo function. Front-loading 6-CD changer with MP3 compatibility and active front and rear speakers. Includes colour centre console screen, SD memory-card reader and AUX-IN socket. Cannot be combined with Satellite Navigation	•	•	•	•	£191.49	£225.00
<b>QV3</b>	<b>DAB digital radio.</b> Integrated into MMI, receives digitally-transmitted radio stations in addition to the range of analogue stations. Displays music track, artist and radio program; capable of 'DAB slideshow' where transmitted. Reception dependent on local digital network. Automatic switch from DAB to FM reception if the network signal is not strong enough	•	•	•	S	£255.32	£300.00
<b>QU1</b>	<b>DAB digital radio in combination with TV reception</b> – analogue and digital. Only in combination with Satellite Navigation system – HDD-based	•	•	•	•	£978.72	£1,150.00

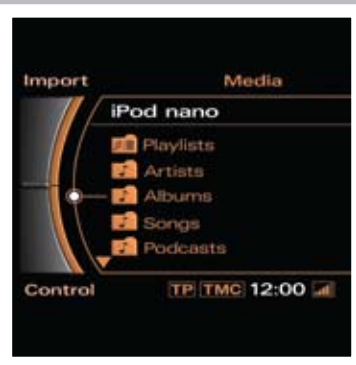

Audi Music Interface



Control panel for HDD Satellite Navigation and MMI High



MMI High media options menu

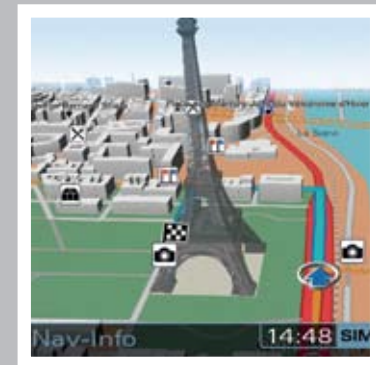

HDD Satellite Navigation 3D building display

# Audio and communication

Order Code		Standard	SE	S line	S line Special Edition	Basic RRP	Total RRP inc VAT
<b>PNG</b>	<b>Satellite Navigation system – HDD-based including MMI High.</b> 3rd generation MMI system including single CD/DVD player, 2 FM tuners, high resolution (800x400) 7" colour TFT display, 2 SD card readers and 40GB hard drive, 10GB of which can be used to store up to 4,000 songs. HDD Satellite Navigation functionality includes advanced speech recognition, 3D and topographical mapping display and advanced 3D building display – must be combined with multi-function steering wheel	●	●	●	●	£1,659.57	£1,950.00
<b>9ZX</b>	<b>Mobile telephone preparation – Bluetooth interface.</b> Provides handsfree connection via Bluetooth using mobile phone aerial. Please contact your Audi Centre for phone compatibility. Only in combination with multi-function steering wheel	●	●	●	S	£208.51	£245.00
<b>9ZW</b>	<b>Mobile telephone preparation – High with Bluetooth and voice control.</b> Provides handsfree connection using an external aerial for optimal reception via a Bluetooth interface. Operated via the optional MMI system and integrated telephone voice-control system. Please note that your mobile phone must have SIM-Access Profile facility for full functionality. Only in combination with Satellite Navigation system – HDD-based	–	●	●	–	£553.19	£650.00
		–	–	–	●	£378.72	£445.00
<b>PT4</b>	<b>Mobile telephone preparation – High with Bluetooth privacy handset located in front centre armrest.</b> The cordless handset allows passengers to make private calls, providing remote control of the telephone functions as well as convenient SMS text message function. The handset is charged from a docking station integrated into the front centre armrest. SIM card can be integrated directly into the handset if the mobile phone does not have SIM-Access Profile (SAP). Only in combination with Satellite Navigation system – HDD-based	–	●	●	–	£808.51	£950.00
		–	–	–	●	£634.04	£745.00
<b>PT5</b>	<b>Mobile telephone preparation – Low with Bluetooth and voice control.</b> Provides handsfree connection via Bluetooth using mobile phone aerial. Alternatively, it can use a cradle with charging facility for optimal reception via external aerial. Located in front centre armrest. Cradle available at extra cost – please contact your Audi Centre for phone compatibility	●	–	–	–	£493.62	£580.00
		–	●	●	–	£382.98	£450.00
		–	–	–	●	£208.51	£245.00
<b>9WM</b>	<b>Rear Seat Entertainment.</b> Includes two detachable DVD players/monitors fitted to the back of the front seats (supplied by Audi Genuine Accessories). The backs of the front seats are fitted with mountings and power connections. The system can be used outside the car with a rechargeable battery or mains power connection, which is included in the package. Includes individual remote controls and two sets of headphones	●	●	●	●	£846.81	£995.00
<b>QV9</b>	<b>TV reception – analogue and digital.</b> TV tuner for reception of 'free-to-air' TV channels. Picture display only possible on MMI screen when vehicle is stationary, audio available at all times. Reception dependent upon local digital network availability. Only in combination with Satellite Navigation system – HDD-based	●	●	●	●	£723.40	£850.00

Options are subject to availability and may extend delivery.

- = Not available
- = Available
- S = Standard

RRP – Recommended Retail Price.

VAT is calculated at 17.5% but this may alter to reflect any change in the applicable VAT rate.



# Interior equipment

Specify every detail of your car's interior with this range of exclusive options.

Order Code		Standard	SE	S line	S line Special Edition	Basic RRP	Total RRP inc VAT
8T4	<b>Adaptive cruise control (ACC).</b> Automatic distance regulation, using radar sensors to maintain required distance by braking and accelerating. Four programs (distance 1 to distance 4) set via steering column controls of the cruise control system. Only in combination with colour DIS	●	●	●	●	£936.17	£1,100.00
4F2	<b>Advanced key.</b> Access and authorisation system which automatically exchanges data between key and vehicle, allowing the driver to keep the key in their pocket or bag at all times. To unlock and open, simply lift the exterior door handle. To lock, press the button on the handle. Pressing the start/stop button integrated in the centre console starts and stops the engine	●	●	●	●	£425.53	£500.00
6N5	<b>Alcantara headlining – black.</b> Only in combination with interior light package	●	●	●	●	£851.06	£1,000.00
6N6	<b>Alcantara headlining.</b> Only in combination with interior light package – see page 32 for colour options	●	●	●	●	£851.06	£1,000.00
KT1	<b>Climate cup holder.</b> Allows cup holder to be cooled to 3°C or heated to 58°C. Operated via two control switches (one for hot and one for cold) positioned behind the cup holder. Located between driver and front passenger	●	●	●	●	£85.11	£100.00
6N9	<b>Cloth headlining – black</b>	●	●	S	S	£187.23	£220.00
8T1	<b>Cruise control.</b> For holding any speed above 25mph	●	●	●	●	£187.23	£220.00
6E3	<b>Front centre armrest</b> with storage compartment	●	S	S	S	£110.64	£130.00
VC1	<b>Garage door opener (Homelink®*).</b> Programmable radio-operated remote control for compatible doors/gates. Control buttons integrated in the front roof module	●	●	●	●	£148.94	£175.00
QQ1	<b>Interior light pack.</b> Includes front footwell lighting, active door reflectors, illuminated vanity mirrors, rear reading lights, entrance lights and illuminated glove compartment, vents and internal door controls	●	●	●	●	£136.17	£160.00
3GN	<b>Load-area fixing kit.</b> Includes telescopic bar and securing belt for dividing up luggage compartment	●	●	●	●	£148.94	£175.00
WTC	<b>Luggage package –</b> including front passenger seat – folding (Q2N), rear bench seat plus (SKA), net partition (3CX), rail system with load-securing net (3GN), reversible luggage compartment mat (6S). Not available with lumbar support, S line and electric seats	●	●	–	–	£404.26	£475.00
3FU	<b>Open sky panoramic sunroof.</b> Comprising glass roof with electric slide-and-tilt control and sunshade at front and rear	●	●	●	●	£936.17	£1,100.00
3CX	<b>Removable net partition.</b> Located between rear seats and rear luggage compartment. Can be used with rear seat-back in upright position, one side folded down, or completely folded down	●	●	●	●	£76.60	£90.00
5XF	<b>Retractable and extendable sun visor.</b> Helps protect the driver's eyes against sunlight coming from the side. Only in combination with interior light package	●	●	●	●	£38.30	£45.00
QE5	<b>Storage package –</b> includes nets on the back of the front seats, storage compartment under the front seats (only under passenger seat if memory function is fitted), multi-fastening point in passenger footwell, luggage spider-net for boot floor, net under rear parcel shelf and lockable glove compartment	●	●	●	●	£102.13	£120.00

Options are subject to availability and may extend delivery.

– = Not available  
● = Available  
S = Standard

\*Homelink® is a registered trademark of Johnson Controls. For more information on compatibility visit [www.homelink.com](http://www.homelink.com)

RRP – Recommended Retail Price.

VAT is calculated at 17.5% but this may alter to reflect any change in the applicable VAT rate.

# Interior equipment

Order Code			Standard	SE	S line	S line Special Edition	Basic RRP	Total RRP inc VAT
9AQ	3-zone electronic climate control. Includes separate air distribution and digital temperature displays for driver and front passenger. Standard on 3.0 TDI models	4-cylinder models	-	●	●	●	£382.98	£450.00
		6-cylinder models	-	S	S	S	No charge	No charge
65J	Reversible load floor mat. Luggage compartment floor mat can be reversed to provide a rubber mat which extends to protect rear bumper. Includes bumper cover		●	●	●	●	£68.09	£80.00
3Y4	Side window blinds – manual		●	●	●	●	£85.11	£100.00
65N	Under-floor storage tray in luggage compartment. Size will differ depending on trim/options		●	●	●	●	£51.06	£60.00
YSQ S3G	Audi exclusive carpets (includes 4 Audi exclusive floor mats with leather piping, cannot be combined with option YSR/S3G – Audi exclusive floor mats)*		-	●	●	●	£782.98	£920.00
YSR S3G	Audi exclusive floor mats with leather piping (cannot be combined with option YSQ/S3G – Audi exclusive carpets)*		-	●	●	●	£306.38	£360.00

\*The colours of the carpet and floor mats with leather piping can be selected from any of the exclusive colours shown on page 32.

Options are subject to availability and may extend delivery.

- = Not available  
● = Available  
S = Standard

RRP – Recommended Retail Price.

VAT is calculated at 17.5% but this may alter to reflect any change in the applicable VAT rate.



# Seats

Choose from a variety of different seat options so you can maintain the right driving posture at all times.

Options are subject to availability and may extend delivery.

- = Not available  
 • = Available  
 S = Standard

RRP – Recommended Retail Price.

VAT is calculated at 17.5% but this may alter to reflect any change in the applicable VAT rate.

Order Code		Standard	SE	S line	S line Special Edition	Basic RRP	Total RRP inc VAT
<b>PV1</b>	<b>Electrically-adjustable front seats.</b> Includes adjustment for height, forwards and backwards position, backrest angle and lumbar support	•	•	-	-	£638.30	£750.00
		•	•	•	•	£442.55	£520.00
<b>7P1</b>	<b>Electric lumbar support.</b> For front seats with horizontal and vertical adjustment	•	•	S	S	£195.74	£230.00
<b>PS8</b>	<b>Folding climate comfort seats.</b> Climate-controlled front seats can be heated or cooled according to the driver and front passenger requirements. Includes electrically adjustable front seats with lumbar support and memory function for driver's seat. Only in combination with electrically adjustable, heated, folding, auto-dimming door mirrors with memory function and Milano leather. 2.0 TFSI and 2.0 TDI models include 3-zone climate control	-	•	-	-	£2,178.72	£2,560.00
<b>9AQ</b>		-	•	-	-	£1,795.74	£2,110.00
<b>PV3</b>		•	•	-	-	£1,795.74	£2,110.00
<b>4A3</b>		-	•	-	-	£1,795.74	£2,110.00
<b>Q2N</b>	<b>Folding front passenger seat.</b> Not available with lumbar support, S line or electric seats	•	•	-	-	£106.38	£125.00
<b>4A3</b>	<b>Heated front seats.</b> Individually controlled variable temperature adjustment	•	•	•	•	£234.04	£275.00
<b>4A4</b>	<b>Heated front and rear seats.</b> Individually controlled variable temperature adjustment	•	•	•	•	£425.53	£500.00
<b>5KA</b>	<b>Rear bench seat plus.</b> Allows both the 1/3 and 2/3 sections of the rear bench seat to be independently adjusted by 100mm front and back. Also includes a through-load facility with an integral centre armrest containing a cup holder	•	•	-	-	£144.68	£170.00



Electric front seats



Rear bench seat plus

# Exterior equipment

Make sure your car looks exactly as you want it to by selecting some of the striking options from our detailed list.

Order Code		Standard	SE	S line	S line Special Edition	Basic RRP	Total RRP inc VAT
<b>PX4</b>	<b>Adaptive headlights.</b> Swivelling headlights for improved illumination of a winding road. Includes Xenon Plus headlights with LED daytime-running lights and headlight washers	●	●	–	–	£1,042.55	£1,225.00
<b>8Q5</b>		–	–	●	●	£276.60	£325.00
<b>4ZM</b>	<b>Black styling pack</b> – consists of black roof rails, black window surrounds, radiator grille frame in gloss black, radiator grille in matt black with vertical chrome bars, number plate and fog light surround in matt black. Cannot be combined with off-road styling package	●	–	–	–	£306.38	£360.00
		–	●	●	●	£191.49	£225.00
<b>3S2</b>	<b>Black roof rails</b>	●	●	●	●	No charge	No charge
<b>2Z7</b>	<b>Deletion of engine capacity designation at rear</b>	●	●	●	●	No charge	No charge
<b>2Z0</b>	<b>Deletion of model and engine capacity designation at rear</b>	●	●	●	●	No charge	No charge
<b>6XE</b>	<b>Door mirrors</b> – electrically adjustable, folding and heated	●	●	●	●	£157.45	£185.00
<b>6XL</b>	<b>Door mirrors</b> – electrically adjustable, folding, heated and auto-dimming with memory function. Only available with memory seats	●	●	●	●	£242.55	£285.00
<b>8N7</b>	<b>High-beam assist.</b> Automatically adjusts headlights from high-beam to dipped-beam when another vehicle is approaching. Can only be ordered in conjunction with light and rain sensor package	–	●	●	●	£85.11	£100.00
<b>4L6</b> <b>8N6</b>	<b>Light and rain sensor package.</b> Includes auto-dimming rear-view mirror, automatic headlight activation, automatic windscreen wipers and the coming home/leaving home function	●	S	S	S	£255.32	£300.00
<b>VJ2</b> <b>PQ2</b>	<b>Off-road styling package</b> – including front and rear lower bumper spoilers with stainless steel underbody protection in off-road design, wheel arch extensions in stone grey, front grille with vertical chrome struts and 19” ‘5-arm off-road’ design alloys. Cannot be combined with black styling package	●	–	–	–	£3,234.04	£3,800.00
		–	●	–	–	£2,553.19	£3,000.00
<b>4E9</b>	<b>Power operated tailgate.</b> Opens by pressing button on the car key, button in the driver’s door trim or soft-touch button in the handle recess on the luggage compartment lid. Including lid-closing assistance unit and programmable angle for the luggage compartment lid	●	●	●	S	£319.15	£375.00
<b>4KF</b>	<b>Privacy glass.</b> Dark tinted glass from B-pillar backwards	●	●	●	●	£276.60	£325.00
<b>1D4</b>	<b>Towing equipment</b> – manual and swivelling	●	●	●	●	£553.19	£650.00

# Warranty extensions

Options are subject to availability and may extend delivery.

- = Not available
- = Available
- S = Standard

RRP – Recommended Retail Price.

VAT is calculated at 17.5% but this may alter to reflect any change in the applicable VAT rate.

<b>EA6</b>	<b>1-year Warranty Extension.</b> Audi Warranty Extension, prolonging your 3-year/60,000-mile Audi warranty to 4 years or 75,000 miles (whichever comes sooner). Comprehensive cover equivalent to the Audi warranty, protecting you against unexpected repairs. Only available as a new car option. Transferable between owners	●	●	●	●	£446.81	£525.00
<b>EA9</b>	<b>2-year Warranty Extension.</b> Audi Warranty Extension, prolonging your 3-year/60,000-mile Audi warranty to 5 years or 90,000 miles (whichever comes sooner). Comprehensive cover equivalent to the Audi warranty, protecting you against unexpected repairs. Only available as a new car option. Transferable between owners	●	●	●	●	£1,046.81	£1,230.00

# Safety and security

Intelligent technology designed to give you better all-round awareness and safety on the road.

Order Code		Standard	SE	S line	S line Special Edition	Basic RRP	Total RRP inc VAT
7X1	<b>Acoustic parking system</b> (rear only). Aids parking by acoustically indicating distances to obstacles	●	S	S	S	£280.85	£330.00
UH2	<b>Audi hill-hold assist.</b> Automatically activates electromechanical parking brake when stationary	●	●	●	●	£38.30	£45.00
PU1	<b>Audi lane assist.</b> Uses a discreet camera mounted at the top of the windscreen to monitor the road ahead. The driver is warned via a vibration of the steering wheel if the vehicle is about to exit the lane unintentionally. Only available in combination with a 4-spoke multi-function steering wheel. S line badging and stitching are not available	●	●	●	●	£340.43	£400.00
7X4	<b>Audi parking system plus.</b> Aids parking by acoustically and visually indicating distances to obstacles	●	-	-	-	£553.19	£650.00
		-	●	●	●	£272.34	£320.00
7X8	<b>Audi parking system advanced.</b> Aids parking by acoustically and visually indicating distances to obstacles with guiding lines. Measured by sensors and reversing camera. Only in combination with Satellite Navigation system – HDD-based	●	-	-	-	£851.06	£1,000.00
		-	●	●	●	£570.21	£670.00
	In combination with technology pack	●	●	●	●	£302.13	£355.00

Options are subject to availability and may extend delivery.

- = Not available
- = Available
- S = Standard

RRP – Recommended Retail Price.

VAT is calculated at 17.5% but this may alter to reflect any change in the applicable VAT rate.

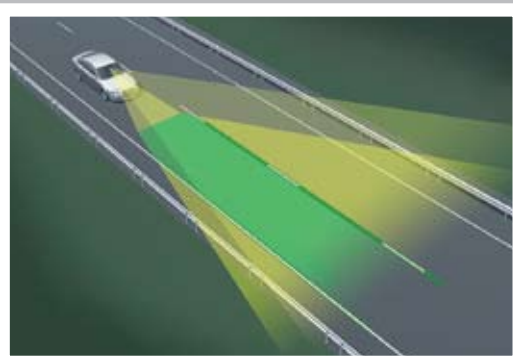

Audi lane assist



Audi lane assist – steering wheel vibration



Audi parking system advanced

# Safety and security

Order Code		Standard	SE	S line	S line Special Edition	Basic RRP	Total RRP inc VAT
7Y1	<b>Audi side assist.</b> Aids the driver when changing lane. Audi side assist monitors the area behind your car using radar sensors located discreetly in the rear bumper. It then informs the driver with a visual warning signal in the door mirror if there is a vehicle in their blind spot or approaching quickly from behind. The system is activated using a button in the driver's door	●	●	●	●	£382.98	£450.00
PU2	<b>Audi side assist and lane assist</b>	●	●	●	●	£723.40	£850.00
8X1	<b>Headlight washers</b>	●	●	S	S	£191.49	£225.00
4X4	<b>Rear side airbags.</b> Situated in side of rear seats.	●	●	●	●	£212.77	£250.00

Options are subject to availability and may extend delivery.

- = Not available
- = Available
- S = Standard

RRP – Recommended Retail Price.

VAT is calculated at 17.5% but this may alter to reflect any change in the applicable VAT rate.



# Steering wheels

You can choose from a selection of advanced leather multi-function steering wheels, allowing you to control your audio system at the touch of a button.

Options are subject to availability and may extend delivery.

- = Not available
- = Available
- S = Standard

\*In any of the 11 exclusive colours shown on page 32.

RRP – Recommended Retail Price.

VAT is calculated at 17.5% but this may alter to reflect any change in the applicable VAT rate.

Order Code		Standard	SE	S line	S line Special Edition	Basic RRP	Total RRP inc VAT
<b>1XW</b>	<b>3-spoke multi-function steering wheel.</b> Manual models only	•	-	-	-	£340.43	£400.00
		-	•	-	-	£85.11	£100.00
		-	-	S	S	No charge	No charge
<b>1XX</b>	<b>3-spoke multi-function steering wheel with gear-shift paddles.</b> S tronic models only	•	-	-	-	£468.09	£550.00
		-	•	S	S	£212.77	£250.00
<b>2ZQ</b>	<b>4-spoke multi-function steering wheel.</b> Manual models only – includes Driver's Information System	•	-	-	-	£255.32	£300.00
		-	S	•	•	No charge	No charge
<b>6Q6</b>	<b>Audi aluminium gear knob (manual models only)</b>	•	•	•	•	£102.13	£120.00
<b>YRH S3G</b>	<b>Audi exclusive leather steering wheel*</b>	-	•	•	•	£391.49	£460.00
<b>YRB S3G</b>	<b>Audi exclusive control package.</b> Includes leather covered steering wheel and gear-shift gaiter*	-	•	•	•	£565.96	£665.00



# Off-road capabilities of the Audi Q5

The Audi Q5 excels both on the road and off it, thanks to its impressive all-terrain abilities. And these attributes are reinforced by special technologies, such as hill descent assist, ABS with automatic off-road detection and an Electronic Stability Programme that includes an off-road mode.

## Hill descent assist

Available as standard in the Audi Q5, hill descent assist automatically maintains the speed set by the driver on steep descents and on any surface (up to 19mph). This makes negotiating descents far more straightforward and substantially enhances stability. Hill descent assist is activated and deactivated using a separate button.

## ESP off-road mode

The Electronic Stability Programme in the Audi Q5 features a special off-road mode which can be controlled by a switch. This reprograms the ESP system, traction control and anti-lock braking system to adapt them to the driving conditions encountered in off-road terrain, such as sand, gravel or mud. This leads to good traction in all conditions, a more exciting drive and great handling even on difficult surfaces.

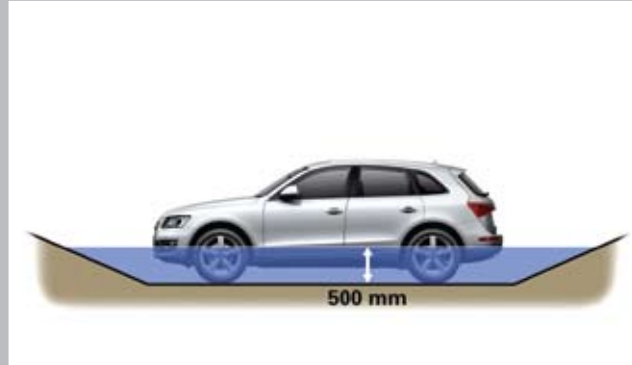

Wading



Ground clearance

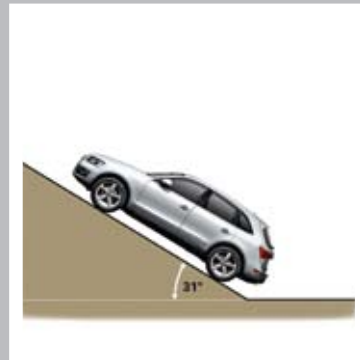

Maximum gradient



Slope angle



Ramp angle



# Merchandise

From the enthusiasts' motorsport collection to the sophisticated Audi collection, there's a wide variety of adults' and children's clothing, lifestyle accessories and collectables, all of which bear the Audi name.

Please speak to a member of our team at your local Audi Centre to see the full Audi collection and to place an order. A selection of Audi merchandise is also available to buy from [audi.co.uk/merchandise](http://audi.co.uk/merchandise).



Audi kids



Bags and leather goods



Clothing



Motorsports



Sport and travel



Model cars

# Accessories

Choosing an Audi isn't just a matter of deciding on the model you want; it's about creating a car that suits your needs perfectly. And that's why we've developed a whole range of accessories to enhance your Audi Q5, enabling you to customise it down to the last detail. Like your Audi, all these accessories are developed to the highest possible standards. And they're all available exclusively from Audi.

To find out more, just visit [audi.co.uk/accessories](http://audi.co.uk/accessories) or contact your local Audi Centre.

## Warranty

All of the accessories available on the Audi Q5 are covered by a three-year warranty\* if they are ordered and included in the purchase price of the car at date of delivery. Any accessories ordered and installed after delivery include a two-year warranty.\*



Sport and design



Transport and touring



Entertainment and communication



Comfort and protection

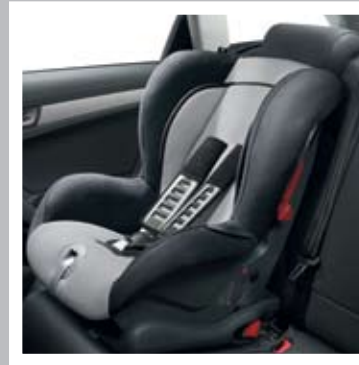

Family



Safety and security

\*Excluding Road Angel products.  
Audi Accessories warranty terms and conditions can be found at [audi.co.uk](http://audi.co.uk)

# Audi Q5 Petrol technical data

Engine	2.0 TFSI quattro®	2.0 TFSI quattro®	2.0 TFSI quattro®	3.2 FSI quattro®
Transmission	6-speed manual	6-speed manual	7-speed S tronic®	7-speed S tronic®
Cylinder	4-cylinder	4-cylinder	4-cylinder	6-cylinder
Displacement, cubic cm (valves per cylinder)	1984 (4)	1984 (4)	1984 (4)	3197 (4)
Max. power <sup>1</sup> , PS at rpm	180/4000-6000	211/6000	211/6000	270/6500
Max. torque, Nm at rpm	320/1500-3900	350/1500-4200	350/1500-4200	330/3000-5000
0-62mph acceleration, seconds	8.5	7.6	7.2	6.9
Top speed, mph	130	138	137	145
CO <sub>2</sub> emissions <sup>2</sup> , g/km	195	195	197	218
Benefit in kind (BIK)%	27%	27%	27%	31%
Fuel consumption, mpg (l/100km) Urban	26.2 (10.8)	26.1 (10.8)	27.1 (10.4)	23.0 (12.3)
Fuel consumption, mpg (l/100km) Extra Urban	40.9 (6.9)	40.9 (6.9)	38.6 (7.3)	37.2 (7.6)
Fuel consumption, mpg (l/100km) Combined	33.6 (8.4)	33.6 (8.4)	33.2 (8.5)	30.4 (9.3)
ABI insurance group 1-20/1-50*	TBC	15/28 E	15/28 E	16/32 E
Unladen weight <sup>3</sup> , kg	1710	1695	1740	1795
Gross weight limit, kg	2320	2275	2320	2375
Roof load limit/nose weight, kg	100/80	100/80	100/80	100/80
Max trailer load <sup>4</sup> unbraked, kg	750	750	750	750
Max trailer load <sup>4</sup> with 12% gradient, kg	2000	2000	2000	2000
Max trailer load <sup>4</sup> with 8% gradient, kg	2200	2400	2400	2400
Luggage compartment capacity, rear seats upright, litres	540	540	540	540
Luggage compartment capacity, rear seats folded, litres	1560	1560	1560	1560
Fuel tank capacity approx, litres	75	75	75	75

\*Highest insurance group rating shown. Group may be lower dependent on trim level. Please visit [www.thatcham.org/abigroupratings](http://www.thatcham.org/abigroupratings) for details.

<sup>1</sup>The given value was obtained in accordance with the specified measurement procedure (the respective current version of the Directive 80/1269/EEC).

<sup>2</sup>The given values were calculated in accordance with the specified measurement procedure (the respective current version of Directive 80/1268/EEC). This information does not relate to a single vehicle and does not comprise part of the offer but is merely intended for the purpose of comparison between the different vehicle types.

<sup>3</sup>Vehicle's unladen weight without driver (calculated in accordance with the current version of Directive 80/1268/EEC). The fitting of additional equipment may increase the vehicle's unladen weight and drag coefficient, whereupon the potential carrying capacity and top speed will be correspondingly reduced.

<sup>4</sup>The engine's power output always goes down with increasing altitude. At 1,000m above sea level, and for every additional 1,000m, deduct 10% from the weight of the outfit (trailer load limit + gross weight of the towing vehicle).

# Audi Q5 Diesel technical data

Engine	2.0 TDI quattro®*	2.0 TDI quattro®*	2.0 TDI quattro®*	3.0 TDI quattro®*
Transmission	6-speed manual	6-speed manual	7-speed S tronic®	7-speed S tronic®
Cylinder	4-cylinder	4-cylinder	4-cylinder	6-cylinder
Displacement, cubic cm (valves per cylinder)	1968 (4)	1968 (4)	1968 (4)	2967 (4)
Max. power <sup>1</sup> , PS at rpm	143/4200	170/4200	170/4200	240/4400
Max. torque, Nm at rpm	320/1750-2500	320/1750-2500	320/1750-2500	500/1500-3000
0-62mph acceleration, seconds	11.4	9.5	9.9	6.5
Top speed, mph	118	126	124	139
CO <sub>2</sub> emissions <sup>2</sup> , g/km	172	175	179	199
Benefit in kind (BIK)%	25%	26%	26%	30%
Fuel consumption, mpg (l/100km) Urban	30.4 (8.1)	34.4 (8.2)	34.4 (8.2)	30.7 (9.2)
Fuel consumption, mpg (l/100km) Extra Urban	50.4 (5.6)	48.7 (5.8)	47.1 (6.0)	42.8 (6.6)
Fuel consumption, mpg (l/100km) Combined	43.5 (6.5)	42.1 (6.7)	41.5 (6.8)	37.6 (7.5)
ABI insurance group 1-20/1-50**	TBC	14/22 E	14/22 E	17/31 E
Unladen weight <sup>3</sup> , kg	1745	1730	1770	1865
Gross weight limit, kg	2355	2310	2350	2445
Roof load limit/ nose weight, kg	100/80	100/80	100/80	100/80
Max trailer load <sup>4</sup> unbraked, kg	750	750	750	750
Max trailer load <sup>4</sup> with 12% gradient, kg	1800	2000	2000	2000
Max trailer load <sup>4</sup> with 8% gradient, kg	2000	2400	2400	2400
Luggage compartment capacity, rear seats upright, litres	540	540	540	540
Luggage compartment capacity, rear seats folded, litres	1560	1560	1560	1560
Fuel tank capacity approx, litres	75	75	75	75

\*With Diesel Particulate Filter

\*\*Highest insurance group rating shown. Group may be lower dependent on trim level. Please visit [www.thatcham.org/abigroupratings](http://www.thatcham.org/abigroupratings) for details.

<sup>1</sup>The given value was obtained in accordance with the specified measurement procedure (the respective current version of the Directive 80/1269/EEC).

<sup>2</sup>The given values were calculated in accordance with the specified measurement procedure (the respective current version of Directive 80/1268/EEC). This information does not relate to a single vehicle and does not comprise part of the offer but is merely intended for the purpose of comparison between the different vehicle types.

<sup>3</sup>Vehicle's unladen weight without driver (calculated in accordance with the current version of Directive 80/1268/EEC). The fitting of additional equipment may increase the vehicle's unladen weight and drag coefficient, whereupon the potential carrying capacity and top speed will be correspondingly reduced.

<sup>4</sup>The engine's power output always goes down with increasing altitude. At 1,000m above sea level, and for every additional 1,000m, deduct 10% from the weight of the outfit (trailer load limit + gross weight of the towing vehicle).

# Audi Q5 dimensions

The technical drawings opposite show the exact dimensions of the Audi Q5, so you can check everything – from whether the car will fit in your garage to whether your luggage will fit in the boot.

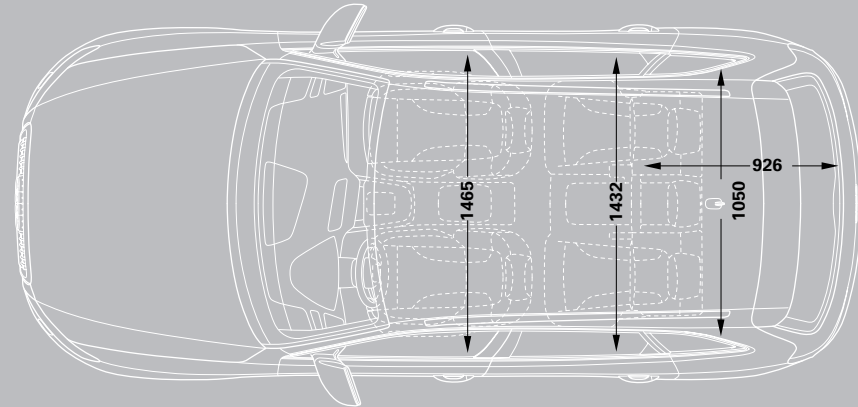
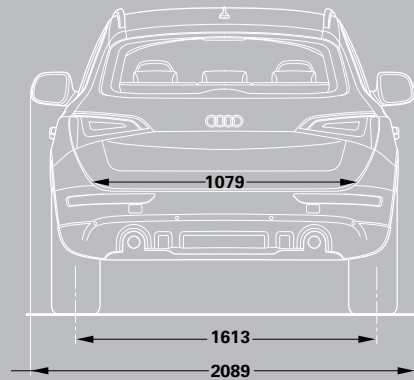
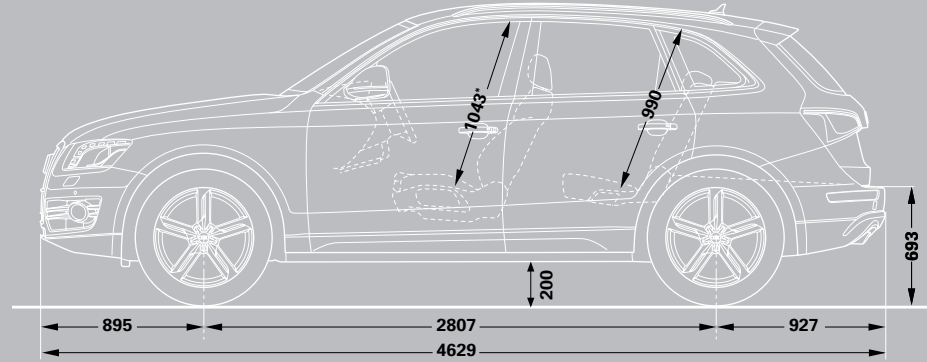
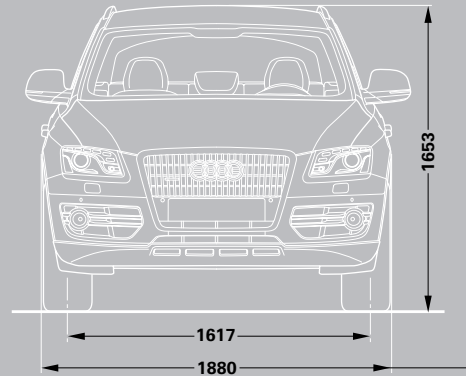

Dimensions were measured with vehicle at unladen weight.

Turning circle approx 11.7m.

Dimensions in millimetres.

\*Maximum headroom.

# Additional information

## CO<sub>2</sub> data and information

### CO<sub>2</sub> emissions-based Vehicle Excise Duty

Vehicle Excise Duty (Road Fund Licence) is based upon the amount of Carbon Dioxide (CO<sub>2</sub>) a vehicle emits, measured in grams per kilometre (g/km). The DVLA has created thirteen categories:

#### Petrol and Diesel engines

A - up to 100g/km	£0.00
B - 101 to 110g/km	£35.00
C - 111 to 120g/km	£35.00
D - 121 to 130g/km	£120.00
E - 131 to 140g/km	£120.00
F - 141 to 150g/km	£125.00
G - 151 to 165g/km	£150.00
H - 166 to 175g/km	£175.00
I - 176 to 185g/km	£175.00
J - 186 to 200g/km	£215.00
K* - 201 to 225g/km	£215.00
L - 226 to 255g/km	£405.00
M - over 255g/km	£405.00

\*Band K includes cars that have a CO<sub>2</sub> figure over 225g/km but were registered before 23 March 2006.

Vehicle Excise Duty (VED) rates correct at time of going to print, but these may alter to reflect any change in the applicable VED rate

### Servicing tailored to your needs

Regular servicing is key to safeguarding your Audi's performance and a full Audi service history could help you preserve the future re-sale value. To make servicing easy, the Audi Service Schedules have been designed to work with your individual driving style and vehicle.

There are two schedules available and your Audi Centre will advise which schedule is most suited to your needs. The conventional fixed Audi Inspection Service schedule has fixed intervals for the Oil-change and Inspection Service that are based on time

and distance, whichever comes first. With the Audi LongLife Service schedule, sensors take account of driving style and conditions in which the vehicle is used to indicate when the Oil-change Service is required. Oil-change Service intervals are therefore variable and are conveniently indicated via the on-board service interval display.

#### Fixed Inspection Service Schedule

	Vehicle usage:
Mileage	Less than 10,000 miles per annum
Type of journey	Mainly city/town centre driving. Short journeys
Conditions	Frequent cold starts. High engine loading – e.g. frequent hill climbs, vehicle fully loaded, towing
Driving style	Uneconomical – e.g. heavy acceleration, heavy braking, constant changes in speed, constant use of high revs, 'sporty' driving
	Service Intervals:
Oil-change Service	Fixed to every 9,000* miles/1 year
Inspection Service	Fixed to every 19,000* miles/2 years

#### Variable LongLife Service Schedule

	Vehicle usage:
Mileage	More than 10,000 miles per annum
Type of journey	Motorway and main road driving. Mainly longer distance journeys. Constant speeds
Conditions	Normal engine loading – e.g. with little or no towing, with little or no hill climbs. Normal vehicle loading
Driving style	Moderate acceleration, moderate braking, engine revs mainly below 3,000
	Service Intervals:
Oil-change Service	Variable to a maximum of every 19,000* miles/2 years
Inspection Service	Fixed to every 19,000* miles/2 years

\*As indicated by the service interval display. Mileages are approximate as the Service Indicator system uses kilometres as its distance measurement.

# Additional information

## Welcome to Audi

By placing an order for your Audi, you're choosing to get behind the wheel of one of the most sophisticated cars on the road. And because we believe the service we offer should be just as advanced, we wanted to let you know exactly what you can expect from us, now and in the future.

We've agreed a set of standards with all our Centres, which governs the way we do business with you. It outlines the kind of service we promise to deliver for every customer, right down to filling each new Audi we sell with half a tank of fuel.

So whether you're interested in the date your car will arrive in the UK or the way we'll dispose of non-biodegradable materials after we service your Audi, you can have total confidence in us.

## Audi Promise

### Audi Centres

We guarantee that all of our Centres will be open as follows:

Sales: Monday to Friday 9am–6pm  
Saturday 9am–5pm

Service: Monday to Friday 8am–6pm  
Saturday 8.30am–1pm

Sunday opening is at local discretion.

### New car delivery

Once we've confirmed a delivery date for your car, we'll keep you informed of progress. Subject to reasonable notice, we'll then deliver it to a place of your choice, whether that's your home or place of work. In the unlikely event of a delay, we'll provide a courtesy car to minimise inconvenience and keep you mobile.

### The experts in Vorsprung durch Technik

Would you entrust your Audi to anyone who hasn't been regularly trained to Audi standards? Our network of Audi Approved Master Technicians have undergone an impressive 100,000 hours of training over a 10-year programme to ensure they have the latest technical expertise for maintaining and servicing your Audi. All of our Service Advisors undergo a specialist induction and training to ensure they are Audi professionals and able to talk to you about any issues you may have with your Audi vehicle. What's more, we have so much expertise and experience in looking after Audi vehicles that we are able to make a note of your mileage and the state of your vehicle as and when we see it and predict when certain key events may occur. As part of our duty of care, we will notify you in plenty of time so you can make an appointment with us.

### Your convenience comes first

At Audi you can choose from a range of convenient services that suit your needs. Why not book a 'service while you wait' appointment\* and enjoy our complimentary refreshments while your car is with us? Or, if you need to be mobile, take advantage of one of our courtesy cars which we can even collect and deliver to you.\* We guarantee we can service your Audi within 5 days without a courtesy car, or within 10 days if you need transport. We will also ensure your car is returned to you with a full valet.

### Audi Genuine Parts

Would you put a part into your Audi that wasn't the same quality as the factory fitted original? You can rest assured that only Audi Genuine Parts will be used on your vehicle. What's more, Audi parts and labour come with a 2-year guarantee.\*\* We stock a wide variety of parts, so we are well covered. However, if we don't have a part in stock at our Centre we have the back-up of parts at other Audi Centres, at our national warehouse and our factory and can usually source the relevant part very quickly.

### We don't like surprises either

We believe strongly in transparency and there will be no hidden costs. For added peace of mind, we will give you a quotation over the phone for the work you have requested and email you the price confirmation. We'll consult you if any additional work on your car is needed when it is with us. We won't carry out any extra work without asking your permission first.

### The Audi Stamp

Regular servicing is key to safeguarding your Audi's performance and a full Audi service history could help you preserve the future re-sale value of your car. Only the Audi Stamp will prove your approved Audi service history.

### Getting better every time

We continually gather feedback from our Audi Trained Technicians, as well as our customers, to ensure our vehicles are running as they should. Whenever we see an Audi for a service, we connect it directly to our headquarters in Ingolstadt which enables us to check your car's software and make sure it's as up-to-date as possible. If the factory has released a software upgrade for your model, it can be applied immediately – improving anything from your car's efficiency to the precision of its parking system.

### Environmental commitment

We promise to dispose of all non-biodegradable materials from your vehicle in a responsible manner.

\*Subject to availability.

\*\*Excludes wear and tear.

# Pricing information

## Pricing

Prices and specifications given are correct at the time of printing. Always check details with your Audi Centre, as Audi policies are continually developing. We reserve the right to change prices or specifications at any time.

All prices are subject to VAT, currently charged at 17.5% but this may alter to reflect any change in the applicable VAT rate.

Delivery charges and number plates are not included in the vehicle price.

Delivery charge	£473.62
Number plate	£20.00
VAT	£86.38
Total	£580.00

## Audi Roadside Assistance

Your new car comes complete with complimentary roadside assistance and recovery across the UK provided by RAC Motoring Services. Also included is roadside assistance throughout Europe, managed by RAC Motoring Services.

## Audi Customer Care

Every new Audi benefits from the comprehensive Audi Customer Care Package, which comprises:

- ▶ A 3-year Audi warranty, which covers you for unlimited mileage in the first 2 years of ownership, with a full mechanical and electrical warranty which covers you for up to 60,000 miles in the 3rd year
- ▶ A 3-year paint warranty
- ▶ A 12-year anti-corrosion warranty
- ▶ 3 years' UK roadside assistance and recovery

This package, together with Audi variable service intervals, offers a combination unmatched by any other major manufacturer.

When you order your new car you can also choose to extend your Audi warranty to the lesser of: 4 years/75,000 miles or 5 years/90,000 miles. With full Audi warranty cover for up to 5 years, you'll be protected against unexpected repairs and should you sell your Audi before the warranty has expired it is fully transferable to subsequent owners.

Contact your Audi Centre for full details.

## Audi Tax-Free Sales

If you are entitled to purchase a vehicle free of VAT, normally through Military or Diplomatic privilege, please contact your local Audi Centre for full details.

Should you have any difficulty obtaining the information you require, please call Freephone 0800 585878.

## Audi Finance

Audi Finance specialise in providing funding solutions for Audi drivers. Whether your Audi is for private or business use, there are a range of funding options to choose from.

Below is the full range of finance products.

- ▶ Solutions – a Personal Contract Plan
- ▶ Hire purchase
- ▶ Lease purchase
- ▶ Finance lease
- ▶ Contract hire

With all products, you can choose a fixed-cost maintenance plan designed to help you budget accurately.

No matter what Audi model you choose, your local Audi Centre can provide you with a personalised quote which could fit your budget and motoring needs.

Audi Finance is a trading name of Volkswagen Financial Services (UK) Limited. An offer of finance depends on certain conditions. Available to people over 18 in the UK only.

## Audi Insurance

We want you to start enjoying your new car from day one and thanks to Audi Insurance complimentary seven day cover, you can. Call free on 0800 316 7893 (lines are open Monday to Friday 8am - 9pm, and Saturday 9am - 5pm), provide a few details and a cover note will be sent to your Audi Centre. They will then tax your car and you can drive it away.





**Audi UK**  
Customer Services  
Selectapost 29  
Sheffield  
S97 3FG  
0800 699888  
audi.co.uk

Specifications and prices subject  
to change without notice.

© Audi UK

Printed in the UK  
Edition 1.0 12/09  
2010 model year



**FSC**

**Mixed Sources**

Product group from well-managed  
forests and other controlled sources

Cert no. TT-COC-002327  
[www.fsc.org](http://www.fsc.org)

© 1996 Forest Stewardship Council