



The Audi R8 Coupé and Spyder

Pricing and Specification Guide
Valid from October 2010

Personalising your Audi R8

This guide has been specially designed to let you customise your new car in the way that best suits your unique tastes. Every single feature, from the Audi Space Frame® to the luxurious choice of upholstery, has been created to underline the race-winning performance you'll enjoy behind the wheel of your Audi R8. Alternatively, you can go to audi.co.uk and configure your Audi R8 online.

The Audi R8

Engine	12
Transmissions	13
Technology	14

Model details and prices

R8 V8 model equipment	16
R8 V10 model equipment	18
Model prices	20

Audi exclusive

22

Colour and upholstery

Paint finishes	24
Hood colours	28
R8 Coupé upholstery options	30
R8 Coupé colour and trim guide	31
R8 Spyder upholstery options	32
R8 Spyder colour and trim guide	34
Inlays	38

Options

Wheels, brakes and suspension	40
Audio and communication	42
Interior equipment	44
Luggage sets	46
Seats	48
Exterior equipment	49
Safety and security	50
Steering wheels	50
Service Plan and warranty	51
Merchandise	52

Technical details

Technical data	54
Dimensions	56
Additional information	60
Pricing information	62





Vorsprung durch Technik

Three words that express the very essence of Audi. Vorsprung durch Technik isn't a slogan. It's our way of seeing the world. It is the driving force behind our history of innovation that continues into the 21st century. Indeed, many technologies that Audi pioneered remain in our cars today. Some are milestones in the history of the motorcar.

From our beginnings in 1899, to the Auto Union team's Grand Prix successes in the 1930s and our more recent wins at Le Mans, we have always been at the forefront of the motor industry.

Vorsprung durch Technik makes us who we are. To see more of its influence, just read on.

The R8 heritage

Audi has always enjoyed an enviable track record in the world of motorsport. An unrivalled combination of passion, determination, expertise and Vorsprung durch Technik has helped propel the four rings of Audi past finishing line after finishing line. With the introduction of the revolutionary quattro® all-wheel-drive technology in the early 1980s came a run of victories that will never be forgotten. And thanks to a continuing dedication to innovation and progression, that success has continued right through to the present day.

In 1999, Audi entered Le Mans for the first time. Since then, it has won the legendary endurance race an incredible eight times. It is in recognition of this unprecedented success that the Audi R8 was created – a car that has much more in common with the Le Mans-winning racer than simply a name.









Design and performance

Every detail of the R8's exterior immediately marks it out as a progressive sports car. From the emphatic, structural shape, wide air intakes and sweeping sideblades, to the retractable rear spoiler. But these design features aren't just for show. Each serves its own purpose, whether enhancing the car's aerodynamic potential or cooling the engine which sits directly behind the cockpit. And that's no easy task. Both the 4.2 V8 and 5.2 V10 powerplants are extremely high-revving, with breathtaking performance thanks to FSI® direct petrol injection and quattro® all-wheel-drive. Enabling you to get the most from them are a number of auxiliary technologies – a lightweight aluminium crankcase, spontaneous R tronic® automated 6-speed gearbox and Audi magnetic ride.

Inside its rigid yet lightweight aluminium Audi Space Frame®, the R8 has more than a hint of racing car inspiration in its layout and appearance, with Fine Nappa leather Sports seats, driver oriented instruments and a leather flat-bottomed steering wheel as standard. The perfect setting to enjoy some impressive technologies, including the optional Audi parking system advanced and the 465-Watt 12-speaker Bang & Olufsen surround sound system – if the arresting symphony of the R8's engine wasn't enough. Read on to discover more about the revolutionary Audi R8, including standard and optional equipment, paint colours and prices.

The R8 craftsmanship

The Audi R8 is built on a small production line in a specially-constructed block at the Audi factory in Neckarsulm, Germany. The entire production process – from the bodyshell construction to final assembly – is organised in the same way as it would be in a craft workshop. Small teams of specialists oversee every step of production, subjecting every part and component to intense scrutiny. This ensures that every one of the maximum 29 cars built each day will more than match the customary high-quality standards of the Audi product range.





Engine

FSI® direct-injection technology is a unique Audi innovation that was originally developed for the Le Mans 24-hour endurance race to deliver more power and torque, as well as enhanced fuel efficiency. Precisely the right amount of fuel and air are injected into the combustion chambers, enabling the engine to 'breathe' more easily. It results in reduced heat loss and increased output, with around a 15% reduction in fuel consumption and significantly lower exhaust emissions.



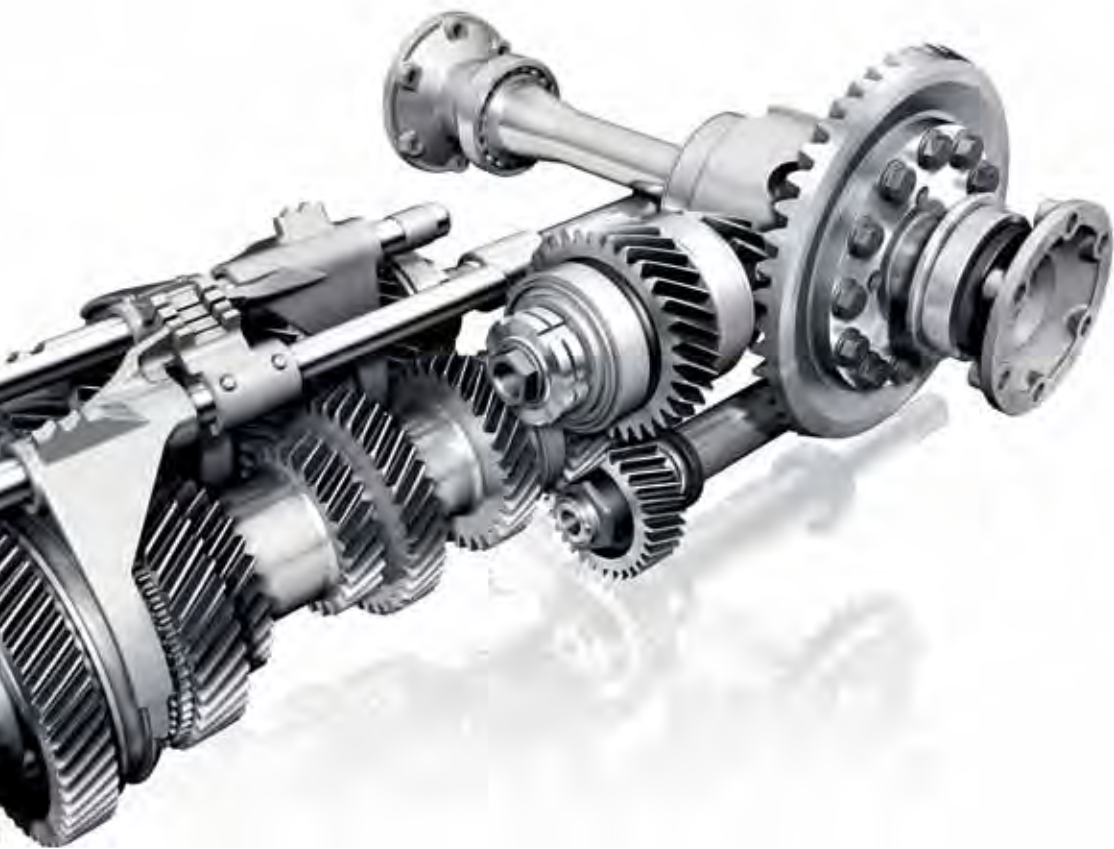

Transmissions

Manual

By specifying a 6-speed manual transmission for your Audi R8, you can put yourself in complete control of your driving experience. The system is matched precisely to the Audi R8's engine configuration and driving dynamics, allowing you to take full advantage of the broad spread of engine torque available across its six closely-spaced gear ratios. With its compact design and low weight, the manual system is a simple, direct way to tap into the power of the Audi R8. The gated system provides short gearshift travel and precise lever movement, giving you the highest possible level of accessibility with the minimum of fuss.

R tronic®

R tronic® is a unique technology developed by Audi, which provides swift and seamless gear-changing for an incredibly sporty drive. Thanks to its groundbreaking electro-hydraulic shifting unit, R tronic® transmits all the force of the Audi R8's engine power to the road with unrivalled smoothness and control. You can drive along with it on automatic mode, or you can select your gears manually with either the gearstick or gearshift paddles. You can also switch to S mode where the ride becomes all the more thrilling: the system delays automatic gearshifts for optimum acceleration, while the pioneering Launch Control provides the kind of lightning-fast performance that allows the Audi R8 to spring from a standing start to 62mph in just 3.9 seconds.*

Technology

quattro®

It's the technology that has given Audi the edge on the racetrack ever since it was first introduced over 30 years ago – a technology that delivers ultimate control whilst enhancing the sporty characteristics which make the Audi R8 so thrilling to drive. It's called quattro® all-wheel-drive. The principle is simple: in the same way that four brakes ensure better deceleration, four permanently-driven wheels deliver better acceleration and road-holding, pushing or pulling the car as needed, for a driving experience that's both dynamic and safe.

In the Audi R8 asymmetric dynamic torque distribution continuously distributes drive power between the front and rear axles depending on weather conditions, road surface and gradient, which increases flexibility for an enhanced, sportier drive.

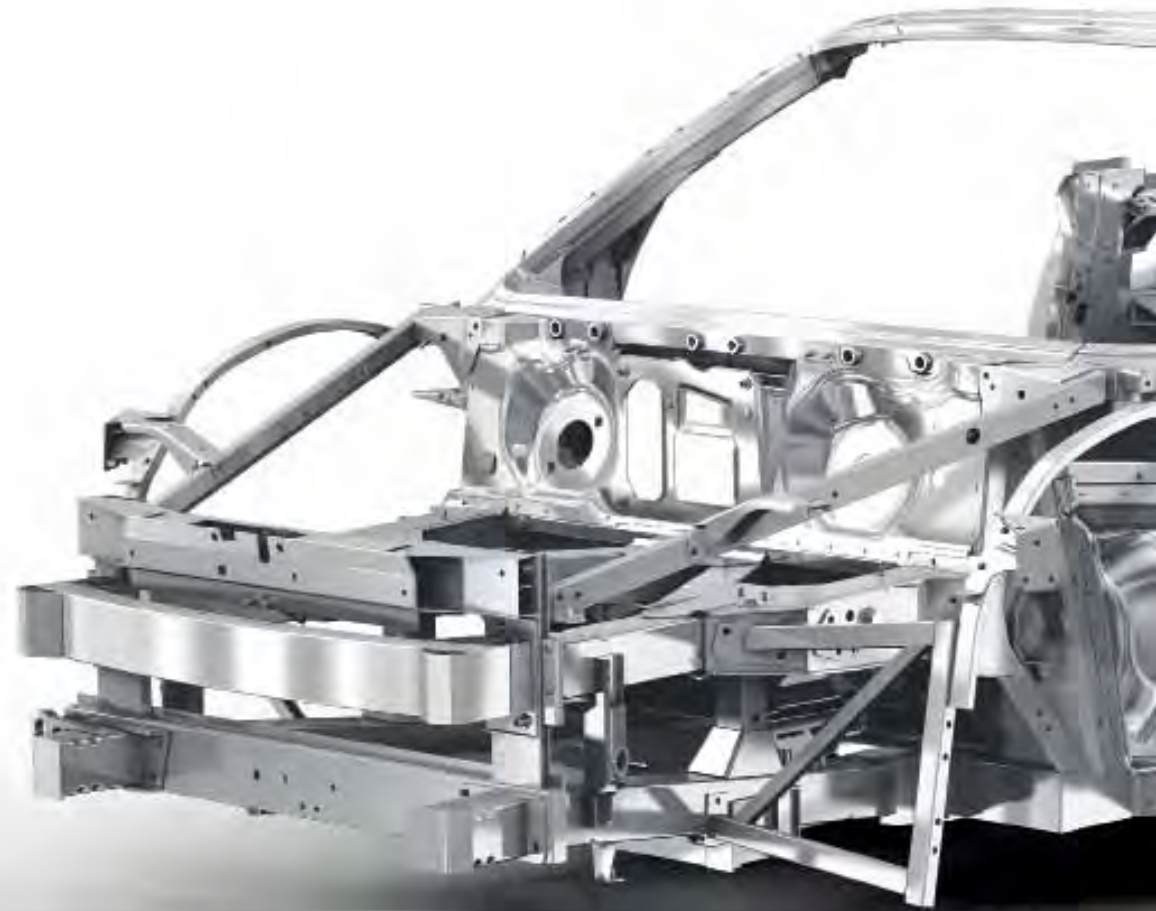

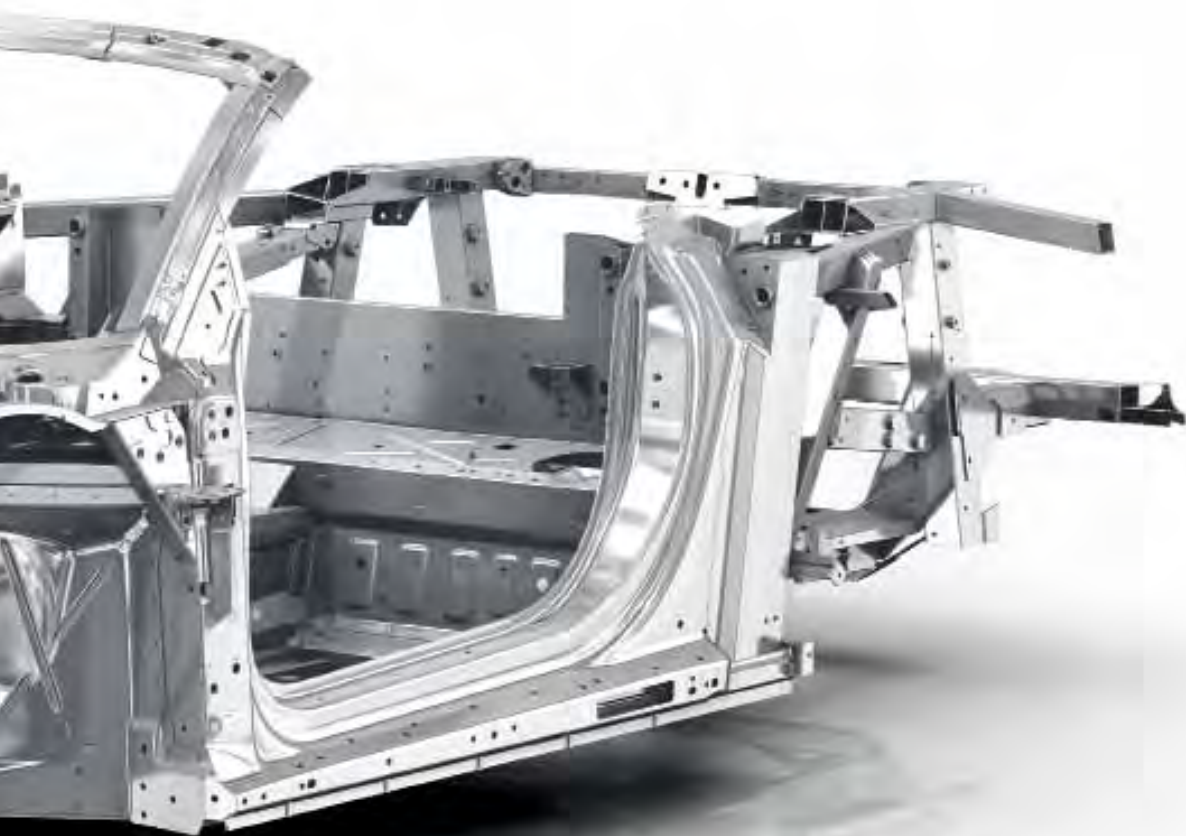

Audi Space Frame®

The Audi R8 is built using a unique Audi Space Frame® which was introduced in 1994 and is both lightweight and extremely strong. It ensures that performance doesn't come at the expense of safety, as the car's body remains tough and beautifully balanced.

Fabric hood

The innovative Z-folding fabric hood of the Audi R8 Spyder is made from an advanced material which is lightweight and flexible. It automatically opens and closes in 19 seconds, with just one touch. Better still, it can operate at speeds of up to 31mph, so you won't have to stop your journey. When lowering, it folds neatly beneath the cover of its compact storage compartment which is just above the powerful engine.

Mid-mounted engine

The Audi R8's engine is mid-mounted, which gives it a low centre of gravity and helps it to achieve the ideal weight balance. The axle load distribution of 44:56* ensures high directional stability and superb road behaviour.

*R8 Coupé models only

Standard model equipment

All Audi R8 V8 models have the following items of standard equipment

Wheels, tyres and suspension

19" '5-arm double-spoke' design alloy wheels, 19 x 8.5J front and 19 x 11J rear with 235/35 and 295/30 tyres

Locking wheel bolts

quattro® all-wheel-drive

Tyre Mobility System

Audio and communication

Concert radio with single front-loading CD player and MP3 file compatibility with active front and rear speakers. Includes AUX-IN socket in centre console

Mobile telephone preparation – Bluetooth interface and voice control with integrated seat belt microphones (Spyder only)

Seats

Electric lumbar support

Sports seats

Electrically adjustable and heated seats (Spyder only)

Safety and security

Anti-lock Braking System (ABS)

Anti-Slip Regulation (ASR)

Anti-theft alarm and electronic immobiliser

Brake lights with LED technology

Disc brakes, internally vented, 8-piston brake callipers at front and 4-piston at rear

Driver, front passenger and front side airbags

Electronic Differential Lock (EDL) traction control

ESP Version 8 – latest generation Electronic Stability Programme networks the ABS, EBD (Electronic Brake Force Distribution), ASR and EDL systems and ensures greater stability at all speeds by braking individual wheels as required and overriding the engine-management system. Driver can select different ESP settings to suit different driving conditions

First aid kit with warning triangle

ISOFIX, with front-passenger airbag-deactivation switch

Remote central locking

Seat-belt reminder

Tool kit including car jack

Paint

Metallic or pearl-effect paint (Spyder only)



Aluminium gear knob and lever gate



19" '5-arm double-spoke' design alloy wheels



Retractable rear spoiler

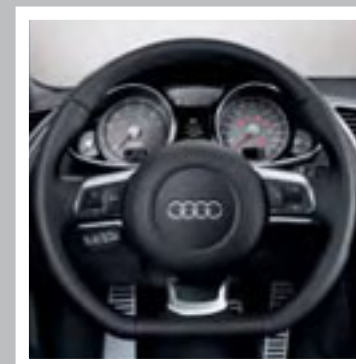

3-spoke flat-bottomed, leather-covered multi-function steering wheel

Exterior equipment

4-branch exhaust system – twin tailpipes on left and right

Door mirrors – electrically operated and heated

Electrically retractable, heated glass rear window (Spyder only)

Exterior lighting, including exit lights

Retractable rear spoiler – deploys and retracts automatically at set speeds, or can be operated manually with the button in centre console

Xenon Plus headlights, including headlight washers and LED daytime-running lights

Fully automatic, acoustic hood with one-touch operation (Spyder only)

Interior equipment

3-spoke flat-bottomed, leather-covered multi-function steering wheel (gearshift paddles standard with R tronic® transmission)

Aluminium gear knob and lever gate

Cup holder – two compartments integrated into centre console

Driver's Information System

Electronic climate control

Fine Nappa leather upholstery, door trim and door handles on passenger side

Heated engine partition window

Inlays in micrometallic grey – upper trim on centre console, centre inlay and door inlay

Interior and instrument lighting

Lockable glove box, with light

Roof lining – black or pale grey

Scuff plates in aluminium with R8 logo

Sun visors with vanity mirror

Valet key

Wind deflector (Spyder only)



Standard model equipment

All Audi R8 V10 models have the following items of equipment in addition to or in replacement of Audi R8 equipment

Wheels, tyres and suspension

19" '10-spoke Y' design alloy wheels, 19 x 8.5J front and 19 x 11J rear with 235/35 and 295/30 tyres

Audio and communication

Bang & Olufsen sound system – 12 speakers, total output 465 Watts

CD changer for six discs (Audi Music Interface can be ordered in lieu of CD changer)

Satellite Navigation system – DVD-based

Safety and security

Tyre pressure monitoring system

Paint

Metallic or pearl-effect paint

Exterior equipment

All-LED headlights (see page 49 for details)

Audi magnetic ride (see page 40 for details)

Auto-dimming and folding door mirrors

Audi hill-hold assist

Light and rain sensor pack, including auto-dimming rear-view mirror, automatic headlights and automatic windscreen wipers

Oval exhaust tailpipes

V10 badges on front wings (and engine bay on Coupé)

Interior equipment

Electrically adjustable seats

Extended Fine Nappa leather package (Spyder only)

Heated front seats

Light package including LED lights illuminating footwell (and engine compartment on Coupé)

Stainless steel pedals



19" '10-spoke Y' design alloy wheels



All-LED headlights



Satellite Navigation system – DVD-based

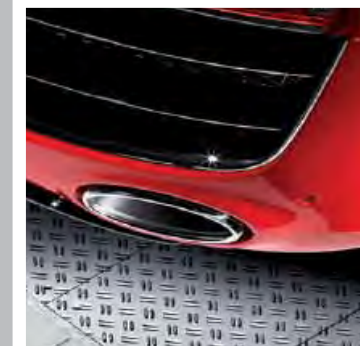

Oval exhaust tailpipes



R8 Coupé

Engines	Power	Transmissions	Basic RRP	Total RRP inc VAT	Recommended OTR
4.2 FSI quattro	430PS	6-speed manual	£71,075.00	£85,290.00	£86,885.00
4.2 FSI quattro	430PS	R tronic	£75,500.00	£90,600.00	£92,195.00
5.2 FSI quattro	525PS	6-speed manual	£88,704.17	£106,445.00	£108,040.00
5.2 FSI quattro	525PS	R tronic	£93,129.17	£111,755.00	£113,350.00

R8 Spyder

Engines	Power	Transmissions	Basic RRP	Total RRP inc VAT	Recommended OTR
4.2 FSI quattro	430PS	6-speed manual	£78,291.67	£93,950.00	£95,545.00
4.2 FSI quattro	430PS	R tronic	£82,716.67	£99,260.00	£100,855.00
5.2 FSI quattro	525PS	6-speed manual	£95,887.50	£115,065.00	£116,660.00
5.2 FSI quattro	525PS	R tronic	£100,312.50	£120,375.00	£121,970.00

Please note: The maximum power output figures are quoted in PS (or Pferdestärke, which is the metric equivalent of brake horsepower). To convert to brake horsepower, divide the PS figure by 1.0139.

Recommended On-The-Road (OTR) retail prices include: delivery charge, half a tank of fuel, number plates at £590.00 (inc. VAT), Road Fund Licence (which may vary depending on model/transmission – see page 60 for details) and first registration fee at £55.00. Vehicle Excise Duty correct at time of going to print, but this may alter to reflect any change in the applicable VED rate.

RRP – Recommended Retail. All prices are subject to VAT at 20% reflecting the VAT rate most likely to be in force at the time of delivery. The VAT rate may change if the vehicle is delivered before 4 January 2011 or if the VAT rate subsequently changes.





Audi exclusive



Audi exclusive

Every Audi is intrinsically exclusive. It's the breathtaking design, the exceptional engineering, the Vorsprung durch Technik. But for that special touch you can specify your new R8 with options from Audi exclusive. Whether you want a unique, custom-mixed paint colour or seats in a combination of complementary shades, Audi exclusive will enable you to drive the car you've always imagined.

Both the exclusive and standard options can be found on the following pages.



Paint

R8 Coupé

To create your ideal R8, just choose one of the colours opposite. To individualise your R8 Coupé sideblades, please refer to page 27.

Options are subject to availability and may extend delivery.

All the colour swatches on this page are matched as accurately as possible to the actual paint colours used. However, due to print processes, Audi UK cannot guarantee that colours shown are 100% accurate.

Visit your local Audi Centre for a more accurate colour swatch.

*Only available on 5.2 FSI quattro models.

RRP – Recommended Retail Price.

All prices are subject to VAT at 20% reflecting the VAT rate most likely to be in force at the time of delivery. The VAT rate may change if the vehicle is delivered before 4 January 2011 or if the VAT rate subsequently changes.

Standard colours



Ibis white
Ice silver sideblade – T9



Brilliant red
Brilliant red sideblade – C8

Optional colours



Ice silver, metallic
Apollo silver sideblade – P5

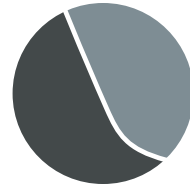

Daytona grey, pearl effect
Quartz grey sideblade – 6Y

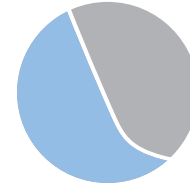

Jet blue, metallic
Ice silver sideblade – 1Y



Sepang blue, pearl effect*
Mugello blue sideblade – E9



Suzuka grey, metallic
Ice silver sideblade – M1



Lava grey, pearl effect
Quartz grey sideblade – 1R

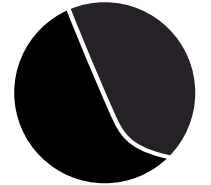

Phantom black, pearl effect
Lava grey sideblade – L8

Optional colours

Basic RRP

R8 – £595.83

R8 V10 – No charge

Total RRP inc VAT

R8 – £715.00

R8 V10 – No charge

Paint

R8 Spyder

Make sure your R8 Spyder looks exactly the way you want it by selecting one of the colours opposite.

Options are subject to availability and may extend delivery.

All the colour swatches on this page are matched as accurately as possible to the actual paint colours used. However, due to print processes, Audi UK cannot guarantee that colours shown are 100% accurate.

Visit your local Audi Centre for a more accurate colour swatch.

*Only available on 5.2 FSI quattro models

*Not available in combination with a Red hood.

RRP – Recommended Retail Price.
All prices are subject to VAT at 20% reflecting the VAT rate most likely to be in force at the time of delivery. The VAT rate may change if the vehicle is delivered before 4 January 2011 or if the VAT rate subsequently changes.

Standard colours



Ibis white – T9

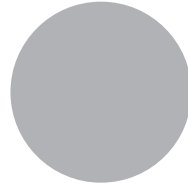

Ice silver, metallic – P5

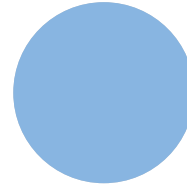

Jet blue, metallic – 1Y

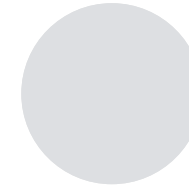

Suzuka grey, metallic – M1

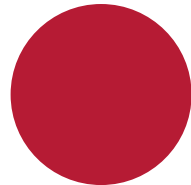

Brilliant red – C8

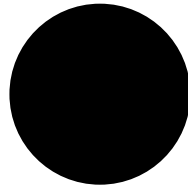

Phantom black, pearl effect – L8

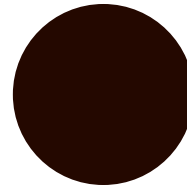

Teak brown, metallic* – 4U

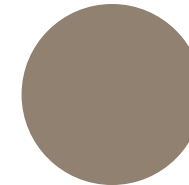

Aurum beige, metallic* – C6

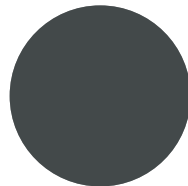

Daytona grey, pearl effect – 6Y

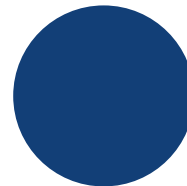

Sepang blue, pearl effect** – E9

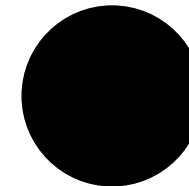

Lava grey, pearl effect – 1R

Standard colours

Basic RRP

No charge

Total RRP inc VAT

No charge

Paint

Audi exclusive

Everyone has a favourite colour. No matter what yours is, Audi exclusive provides a range of unique colours that have been designed to set your car apart. Choose from the swatches here, or specify any other paint colour in the Audi range.

Customised

If you have a particular colour in mind, we'll mix the exact metallic or pearl-effect shade you want.*

Options are subject to availability and may extend delivery.

*Custom paint is subject to factory approval, and is available for metallic and pearl-effect water-based paints only. Three-colour process colours and two-tone schemes are not available.

**Visit your local Audi Centre for colour samples

All the colour swatches on this page are matched as accurately as possible to the actual paint colours used. However, due to print processes, Audi UK cannot guarantee that colours shown are 100% accurate.

RRP – Recommended Retail Price.

All prices are subject to VAT at 20% reflecting the VAT rate most likely to be in force at the time of delivery. The VAT rate may change if the vehicle is delivered before 4 January 2011 or if the VAT rate subsequently changes.

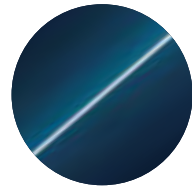

Palace blue, pearl effect

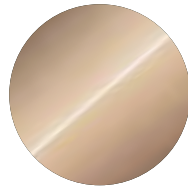

Sand beige, pearl effect

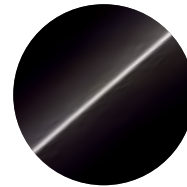

Saddle brown, pearl effect

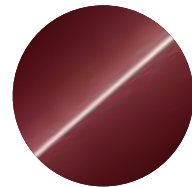

Classic red, pearl effect

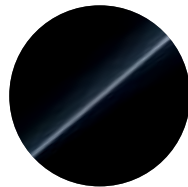

Mamba black, metallic

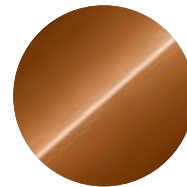

Ipanema brown, metallic



Any colour in the Audi range



100 Audi exclusive colours to choose from**



Customised paint

R8 Coupé V8

Basic RRP

V8 – £2,041.67

Total RRP inc VAT

V8 – £2,450.00

R8 Coupé V10 and R8 Spyder

Basic RRP

V10 – £1,445.83

Total RRP inc VAT

V10 – £1,735.00

Sideblades

The sideblades of the R8 Coupé are among its most distinctive design features. As an alternative to standard paint colours, you can customise your R8 Coupé even further by choosing from one of the options on the right.

Order Code		V8 Coupé	V10 Coupé	V8 Spyder	V10 Spyder	Basic RRP	Total RRP inc VAT
6H2	Oxygen silver	●	●	–	–	£679.17	£815.00
6H3	Carbon sigma	●	●	–	–	£1,275.00	£1,530.00

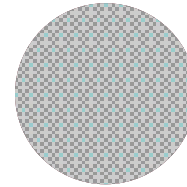

Oxygen silver sideblade – 5Y

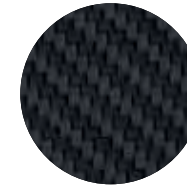

Carbon sigma sideblade – 1Y

Order Code		V8 Coupé	V10 Coupé	V8 Spyder	V10 Spyder	Basic RRP	Total RRP inc VAT
YUY S3G	Sideblade in Audi exclusive paint or customised paint (not in conjunction with sideblade in Carbon sigma or Oxygen silver)	●	●	–	–	£725.00	£870.00

Options are subject to availability and may extend delivery.

- = Not available
- = Available
- S = Standard

*The R8 Coupé sideblades are available in the eight Audi exclusive colours shown opposite.

RRP – Recommended Retail Price.

All prices are subject to VAT at 20% reflecting the VAT rate most likely to be in force at the time of delivery. The VAT rate may change if the vehicle is delivered before 4 January 2011 or if the VAT rate subsequently changes.



Hood colours

The fully automatic acoustic hood is available in the colours opposite, so you can complement your car's interior and exterior.



Black hood – PA



Brown hood – PW

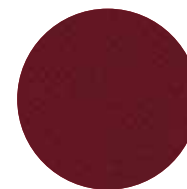

Red hood* – SF



*This option is subject to availability and may extend delivery. Please ask your local Audi Centre for further details.



Upholstery

R8 Coupé

You can specify the R8's interior in the range of colours shown opposite.











Options are subject to availability and may extend delivery.

- = Not available
- = Available
- S = Standard

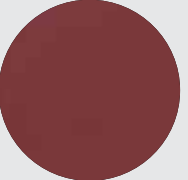
Leather upholstery to seats, door trims and door handle on passenger side (all one colour).

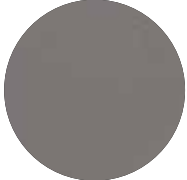
RRP – Recommended Retail Price.

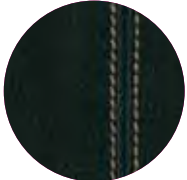
All prices are subject to VAT at 20% reflecting the VAT rate most likely to be in force at the time of delivery. The VAT rate may change if the vehicle is delivered before 4 January 2011 or if the VAT rate subsequently changes.

			V8 Coupé	V10 Coupé	Basic RRP	Total RRP inc VAT	
Fine Nappa leather	 Black – JN/JW	 Pale grey – TN/TH	S	S	No charge	No charge	
	 Luxor beige – TQ/TB	 Mustang brown – JZ					 Red – BF
Leather/Alcantara (N7U)	 Black – JN/JW	 Pale grey – TN/TH	•	•	No charge	No charge	
	<p>Leather/Alcantara upholstery, includes central seat section in Alcantara and seat-side sections and head restraints in leather</p>						
Extended Fine Nappa leather package (PL3)	 Black – PL3	<p>Extended Fine Nappa leather package – Black. Full Fine Nappa leather upholstery to dashboard, top shoulder and side panel, storage compartment in door, monoposto, cowl, knee bolster and function pads (please see page 39 for further details)</p>		•	•	£2,129.17	£2,555.00
Coloured stitching (OUB)	 Black with Pale grey stitching – EL/EM/TN/TH	 Black with Luxor beige stitching – EQ/TQ/TB	•	•	£229.17	£275.00	
	 Black with Mustang brown stitching – EN/JZ	 Black with Red stitching – ER/BF					<p>Coloured stitching for Fine Nappa leather upholstery located on the monoposto, cowl, passenger door handle and rear shelf cover. Please see opposite for colour and trim guide. Only available in conjunction with extended leather package</p>

Colour and trim guide

R8 Coupé

Interior trim colours

To help choose the right interior for your new R8 Coupé, please use this guide showing the carpet, dashboard and headlining colours that have been matched to your chosen upholstery.

Optional coloured stitching (OUB)

Options are subject to availability and may extend delivery.

- = Not available
- = Available
- S = Standard

*Only available with Alcantara headlining

Order Code	Upholstery	Carpet	Dashboard/seams	Headlining	Leather/Alcantara (N7U)	Fine Nappa leather (PL1)
TN	Pale grey	Pale grey	Black/Black	Pale grey	•	•
TH	Pale grey	Pale grey	Black/Black	Black	•	•
TQ*	Luxor beige	Luxor beige	Black/Black	Luxor beige	—	•
TB	Luxor beige	Luxor beige	Black/Black	Black	—	•
JZ	Mustang brown	Black	Black/Black	Black	—	•
JN	Black	Black	Black/Black	Black	•	•
JW	Black	Black	Black/Black	Pale grey	•	•
BF	Red	Black	Black/Black	Black	—	•

Order Code	Upholstery	Carpet	Dashboard/seams	Headlining	Extended leather (PL3)
EL	Black	Black	Black/Pale grey	Black	•
EM	Black	Black	Black/Pale grey	Pale grey	•
EQ	Black	Black	Black/Luxor beige	Black	•
EN	Black	Black	Black/Mustang brown	Black	•
ER	Black	Black	Black/Red	Black	•
TN	Pale grey	Pale grey	Black/Pale grey	Pale grey	•
TH	Pale grey	Pale grey	Black/Pale grey	Black	•
TQ*	Luxor beige	Luxor beige	Black/Luxor beige	Luxor beige	•
TB	Luxor beige	Luxor beige	Black/Luxor beige	Black	•
JZ	Mustang brown	Black	Black/Mustang brown	Black	•
BF	Red	Black	Black/Red	Black	•

Upholstery

R8 Spyder

The leather seats in the Spyder are specially-designed to stay cool, even when it gets hot outside. A special colour pigmentation prevents the leather from overheating, so you can get the most from open-top driving in the middle of summer.









Options are subject to availability and may extend delivery.

- = Not available
- = Available
- S = Standard

Leather upholstery to seats, door trims and door handle on passenger side (all one colour).

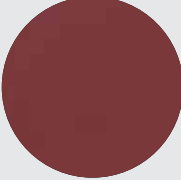
RRP – Recommended Retail Price.

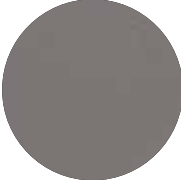
All prices are subject to VAT at 20% reflecting the VAT rate most likely to be in force at the time of delivery. The VAT rate may change if the vehicle is delivered before 4 January 2011 or if the VAT rate subsequently changes.

		V8 Spyder	V10 Spyder	Basic RRP	Total RRP inc VAT
Fine Nappa leather	 Black - JN	S	S	No charge	No charge
	 Titanium grey - FG				
	 Luxor beige - TB				
	 Nougat brown - CZ				
	 Red - FL				
	 Lunar silver - GY				
Leather/Alcantara (N7U)	 Black - JN	•	•	No charge	No charge
	 Titanium grey - FG	Leather/Alcantara upholstery , includes central seat section in Alcantara and seat-side sections and head restraints in leather			
Extended Fine Nappa leather package (PL3)	 Black - PL3	•	S	£2,129.17	£2,555.00
		Extended Fine Nappa leather package – Black. Full Fine Nappa leather upholstery to dashboard, top shoulder and side panel, storage compartment in door, monoposto, cowl, knee bolster and function pads (please see page 39 for further details)			

Upholstery

R8 Spyder (continued)

Coloured stitching (OUB)

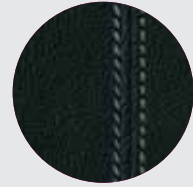

Black with Titanium grey stitching – FJ/FG

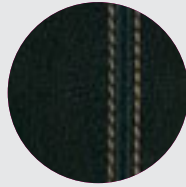

Black with Luxur beige stitching – EQ/TB

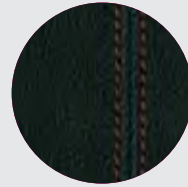

Black with Nougat brown stitching – FN/CZ

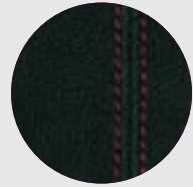

Black with Red stitching – ER/FL



Black with Lunar silver stitching – EA/GY

Coloured stitching for Fine Nappa leather upholstery located on the monoposto, cowl, passenger door handle and rear shelf cover. Please see opposite for colour and trim guide

V8 Spyder	V10 Spyder	Basic RRP	Total RRP inc VAT
•	•	£229.17	£275.00

Options are subject to availability and may extend delivery.

- = Not available
- = Available
- S = Standard

Leather upholstery to seats, door trims and door handle on passenger side (all one colour).

RRP – Recommended Retail Price.

All prices are subject to VAT at 20% reflecting the VAT rate most likely to be in force at the time of delivery. The VAT rate may change if the vehicle is delivered before 4 January 2011 or if the VAT rate subsequently changes.



Colour and trim guide

R8 Spyder

Interior trim colours

To help choose the right interior for your new R8 Spyder, please use this guide, showing the carpet, dashboard and headlining colours that have been matched to your chosen upholstery.

Order Code	Upholstery	Carpet	Dashboard/seams	Headlining	Leather/Alcantara (N7U)	Fine Nappa Leather (PL1)
JN	Black	Black	Black/Black	Black	●	●
FG	Titanium grey	Titanium grey	Black/Black	Black	●	●
TB	Luxor beige	Luxor beige	Black/Black	Black	—	●
GY	Lunar silver	Black	Black/Black	Black	—	●
FL	Red	Black	Black/Black	Black	—	●
CZ	Nougat brown	Black	Black/Black	Black	●	●

Optional coloured stitching (OUB)

Order Code	Upholstery	Carpet	Dashboard/seams	Headlining	Extended leather (PL3)
FJ	Black	Black	Black/Titanium grey	Black	●
FN	Black	Black	Black/Nougat brown	Black	●
EQ	Black	Black	Black/Luxor beige	Black	●
ER	Black	Black	Black/Red	Black	●
EA	Black	Black	Black/Lunar silver	Black	●
FG	Titanium grey	Titanium grey	Black/Titanium grey	Black	●
TB	Luxor beige	Luxor beige	Black/Luxor beige	Black	●
GY	Lunar silver	Black	Black/Lunar silver	Black	●
FL	Red	Black	Black/Red	Black	●
CZ	Nougat brown	Black	Black/Nougat brown	Black	●

Options are subject to availability and may extend delivery.

- = Not available
- = Available
- S = Standard

Leather upholstery to seats, door trims and door handle on passenger side



Upholstery

Audi exclusive

With Audi exclusive, you can choose between Fine Nappa leather and leather/Alcantara, depending on the texture and flexibility you prefer in your car's upholstery. And once that's decided, you can specify your seats in an array of different colours shown here.

Choose just one all-over shade for each seat, or customise each panel in two or more complementary colours from the distinctive Audi exclusive palette. You can even choose the colour of the decorative stitching – to match or contrast with your chosen upholstery – from this varied collection. Whatever combination you decide upon, we think you'll be extremely comfortable with the result.

Options are subject to availability and may extend delivery.

- = Not available
- = Available
- S = Standard

*Leather and stitching (where applicable) can be specified in a variety of colours from the Audi exclusive range.

Please consult your Audi Centre for further information.

RRP – Recommended Retail Price.

All prices are subject to VAT at 20% reflecting the VAT rate most likely to be in force at the time of delivery. The VAT rate may change if the vehicle is delivered before 4 January 2011 or if the VAT rate subsequently changes.

Order Code		V8 Coupé	V10 Coupé	V8 Spyder	V10 Spyder	Basic RRP	Total RRP inc VAT
PYA S3G	Audi exclusive leather package 1 in Fine Nappa leather. Includes leather-covered seat upholstery and door trim inserts. Backrest covers and seat add-on parts come in the interior trim colour*	•	•	•	–	£2,000.00	£2,400.00
PYC S3G	Audi exclusive leather package 1 in Fine Nappa leather/Alcantara. Includes leather-covered seat-side trims, head restraints, door trim inserts and Alcantara seat-centre sections. Backrest covers and seat add-on parts come in the interior trim colour*	•	•	–	–	£1,787.50	£2,145.00
PYF S3G	Audi exclusive leather package 2 in Alcantara/leather. Seat-centre section in Alcantara. Seat-side sections, head restraints and door-trim inserts in Fine Nappa leather. Includes a choice of coloured stitching if desired	–	–	•	–	£4,170.83	£5,005.00
		–	–	–	•	£2,041.67	£2,450.00
PYD S3G	Audi exclusive leather package 2 in Fine Nappa leather. Includes all the contents of leather package 1 (PYA/S3G) plus: leather-covered backrest covers, door armrests and handles and dashboard, and colour-coordinated seat-side trims and add-on parts*	•	•	•	–	£4,170.83	£5,005.00
		–	–	–	•	£2,041.67	£2,450.00
PYN S3G	Audi exclusive R8 leather package in Fine Nappa leather. Includes leather-covered seat-side sections in black plus seat-centre sections in a choice of Silver, Orange or Crimson red with matching stitching on seats, instrument cowl and steering wheel	•	•	–	•	£1,079.17	£1,295.00
YQN S3G	Audi exclusive seat-side trims in Fine Nappa leather for Sports seat. Only available in combination with the Audi exclusive leather package 2*	•	•	•	•	£320.83	£385.00

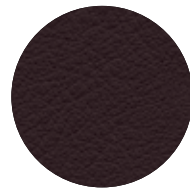

Chestnut brown



Jet grey



Alabaster white

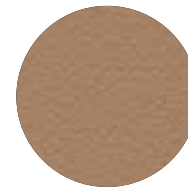

Sand beige

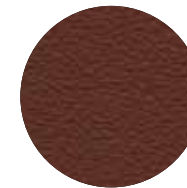

Saddle brown

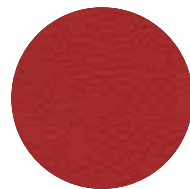

Crimson red



Magnolia white



Havanna brown

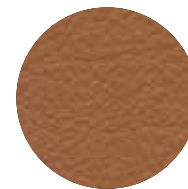

Cognac brown

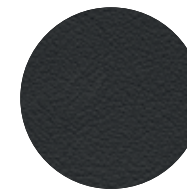

Night blue

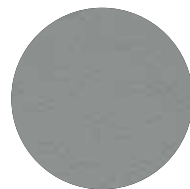

Cloudy grey

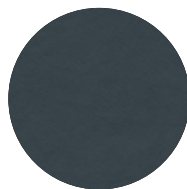

Smoky blue

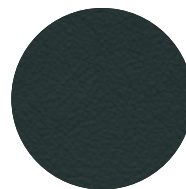

Iceland green

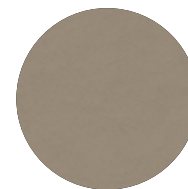

Powder beige

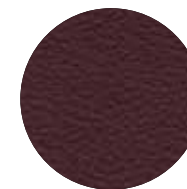

Classic red

Also available:

Alcantara colours: available in all the Audi exclusive colours shown, except for Crimson red, Jet grey and Sand beige. Alcantara equivalents are Chilli red, Amethyst grey, and Sesame beige respectively.

Dashboard: available in all the Audi exclusive colours shown, except for Alabaster white, Magnolia white, and Sand beige.

Please consult your Audi Centre for examples of Alcantara and carpet colours.

Upholstery

Audi exclusive cabin options

*The leather, headlining, stitching and piping (where applicable) can be selected from any of the exclusive colours shown on page 36. The carpet colour can also be selected from any of the exclusive colours shown on page 36, except for Crimson red and Saddle brown.

Audi exclusive control elements

Audi exclusive carpets and floor mats

Options are subject to availability and may extend delivery.

– = Not available
• = Available
S = Standard

RRP – Recommended Retail Price.

All prices are subject to VAT at 20% reflecting the VAT rate most likely to be in force at the time of delivery. The VAT rate may change if the vehicle is delivered before 4 January 2011 or if the VAT rate subsequently changes.

Order Code		V8 Coupé	V10 Coupé	V8 Spyder	V10 Spyder	Basic RRP	Total RRP inc VAT
YQO S3G	Audi exclusive centre console, ashtray cover and radio surround in Fine Nappa leather (only in combination with PYD/S3G)*	•	•	•	•	£1,108.33	£1,330.00
YQW S3G	Audi exclusive monoposto design package in leather. Includes leather-covered monoposto, knee bolster, instrument cowl and door handle trim on driver's side*	•	•	•	–	£1,020.83	£1,225.00
YQP S3G	Audi exclusive leather inlays in Fine Nappa leather. Includes leather-covered door inlays, centre console and door handles (only in combination with PYD/S3G)	•	•	•	•	£508.33	£610.00
YQL S3G	Audi exclusive air vents in Fine Nappa leather. Includes leather-covered air vent louvres, adjustment handles, switch panel trims and side air vent frames. Options PYD or PL3 are recommended with this option	•	•	•	•	£566.67	£680.00
YSK S3G	Audi exclusive headlining in Alcantara (only available on coupé models)*	•	•	•	–	£1,437.50	£1,725.00
YSL S3G	Audi exclusive headlining and rear shelf trim in Alcantara*	•	•	–	–	£2,475.00	£2,970.00
YST S3G	Audi exclusive headlining and rear shelf trim in Fine Nappa leather*	•	•	–	–	£2,608.33	£3,130.00
YSU S3G	Audi exclusive Fine Nappa leather-covered sill trims, carpet cover strip and lower part of A-pillar (only in combination with PYD/S3G)*	•	•	•	•	£379.17	£455.00
YRB S3G	Audi exclusive controls package. Includes leather-covered steering wheel, handbrake grip and gearshift gaiter*	•	•	•	•	£545.83	£655.00
YUC S3G	Audi exclusive control package in black suede. Includes steering wheel rim, handbrake grip and gearshift knob in black suede. Please note that suede on the steering wheel can show signs of wear after a period of time. Stitching colour can be specified in a variety of colours from the Audi exclusive range (only in combination with 6Q2)	•	•	•	•	£545.83	£655.00
YSR S3G	Audi exclusive floor mats with leather piping. Includes 4 floor mats for front and rear (cannot be combined with option YSQ/S3G – Audi exclusive carpets)*	•	•	•	•	£254.17	£305.00
Y TZ S3G	Audi exclusive black floor mats with R8 logo	•	•	•	•	£379.17	£455.00
YSQ S3G	Audi exclusive carpets and rear shelf. Includes 4 Audi exclusive floor mats with piping	•	•	•	•	£1,108.33	£1,330.00
YQM S3G	Audi exclusive luggage compartment lining in Alcantara*	•	•	•	•	£1,370.83	£1,645.00

Inlays

Inlays are the all-important finishing touch that add flair and interest to your car's interior, available in a variety of textures and finishes.

Order Code		V8 Coupé	V10 Coupé	V8 Spyder	V10 Spyder	Basic RRP	Total RRP inc VAT
—	Micrometallic grey – excluding monoposto	S	S	—	—	No charge	No charge
—	Matt silk finish, black – excluding monoposto	—	—	S	S	No charge	No charge
5MN	Carbon sigma	●	●	●	●	£1,404.17	£1,685.00
5TL	Piano finish, black	●	●	●	●	£1,320.83	£1,585.00
YTF S3G	Audi exclusive inlays in body colour. Inlays in centre console, door trim and door handles	●	●	●	●	£2,041.67	£2,450.00

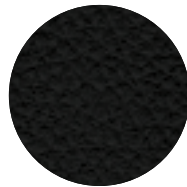

Micrometallic grey

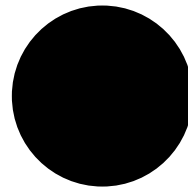

Matt silk finish, black

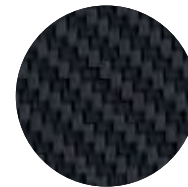

Carbon sigma – 5MN

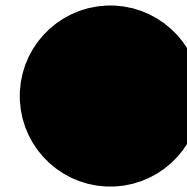

Piano finish, black – 5TL



Audi exclusive inlays in body colour – YTF/S3G

Options are subject to availability and may extend delivery.

— = Not available
● = Available
S = Standard

Please see page 39 for inlay locations.

RRP – Recommended Retail Price.

All prices are subject to VAT at 20% reflecting the VAT rate most likely to be in force at the time of delivery. The VAT rate may change if the vehicle is delivered before 4 January 2011 or if the VAT rate subsequently changes.

Leather trim and inlay packages

Fine Nappa leather upholstery (standard)

- 1 Seats
- 2 Door handle on passenger side matching seat colour
- 3 Door trim insert matching seat colour

Extended Fine Nappa leather package (Standard on R8 Spyder)

- 4 Black dashboard
- 5,6 Black top shoulder and side panel trim
- 7 Black storage compartment in door
- 8 Black monoposto
- 9 Black instrument cowl
- 10 Black cover for storage compartment
- 11 Black knee bolster
- 12 Black function pad

Carbon sigma/Piano finish, black/Audi exclusive inlays in body colour

- 13 Monoposto (excluding Piano finish, black and Audi exclusive inlays in body colour)
- 14 Inlays in centre console
- 15 Inlays in door trim
- 16 Door handle on passenger side

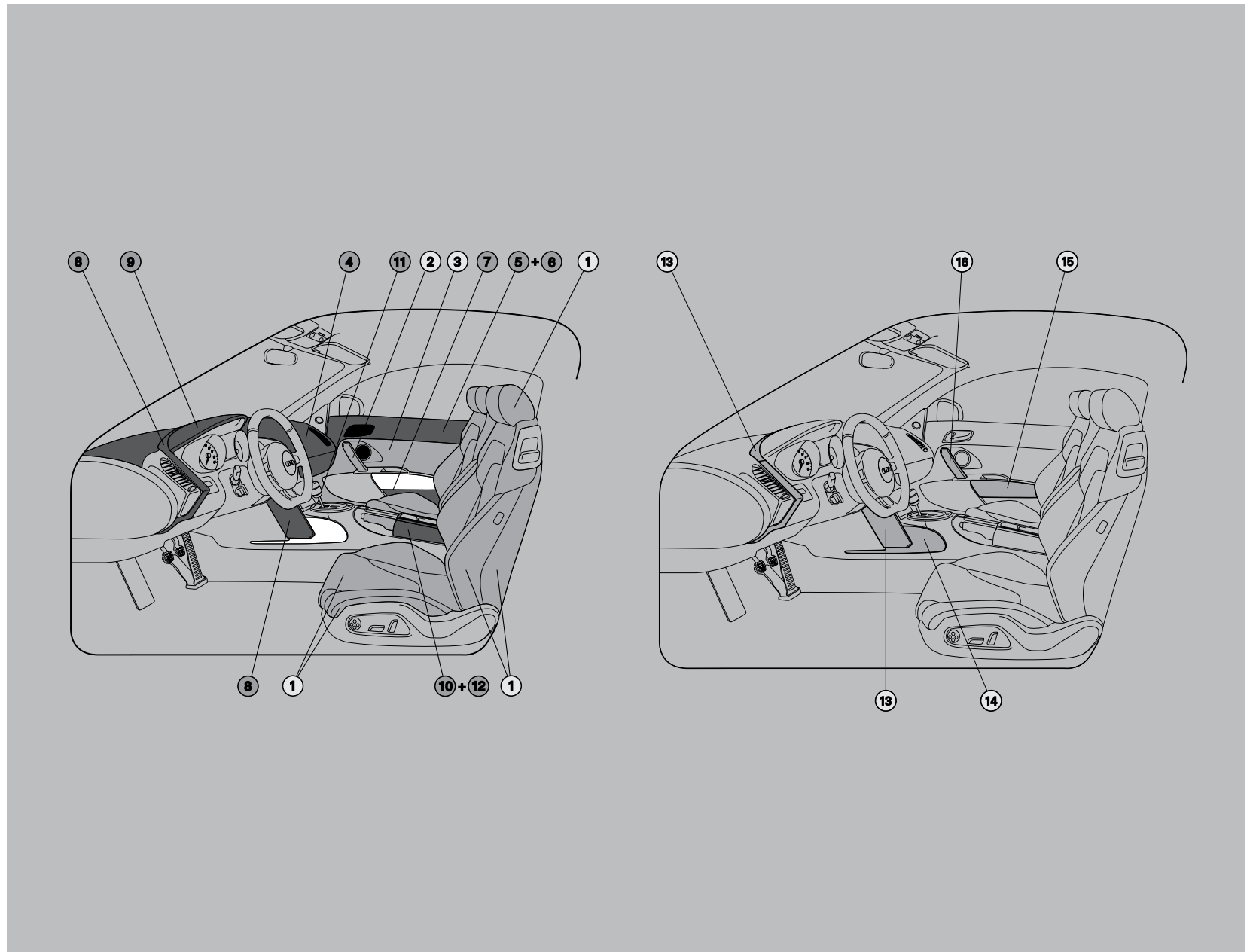

Wheels, brakes and suspension

Choose a set of specially-selected alloy wheels to subtly enhance the way your car looks and drives.

Order Code		V8 Coupé	V10 Coupé	V8 Spyder	V10 Spyder	Basic RRP	Total RRP inc VAT
PQK	19" '5-arm double-spoke' design alloy wheels in titanium finish (19" x 8.5) 235/35 front tyres and 19" x 11) 305/30 rear tyres)	●	–	●	–	£758.33	£910.00
		–	●	–	●	£504.17	£605.00
PQ7	19" '5-arm double-spoke' design alloy wheels in high-gloss finish (19" x 8.5) 235/35 front tyres and 19" x 11) 305/30 rear tyres)	●	–	●	–	£758.33	£910.00
		–	●	–	●	£504.17	£605.00
PQ1	19" '10-spoke Y' design alloy wheels in high-gloss finish (19" x 8.5) 235/35 front tyres and 19" x 11) 295/30 rear tyres)	–	●	–	●	£691.67	£830.00
PQU	19" '5-arm rotor' design alloy wheels in high-gloss finish (19" x 8.5) 235/35 front tyres and 19" x 11) 305/30 rear tyres)	–	●	–	●	£504.17	£605.00
1BL	Audi magnetic ride. Adaptive suspension system with two selectable modes (Normal or Sport). Sensors in the car monitor the road conditions and adjust the damping effect by varying a magnetic charge which passes through a fluid-based shock absorber, delivering improved road handling, outstanding chassis control and excellent driving comfort	●	S	●	S	£1,150.00	£1,380.00
PC5	Ceramic brakes. Lightweight, ventilated ceramic brake discs to all four wheels, 380mm discs at front, 356mm at rear, 6-piston monobloc anthracite coloured brake callipers with 'Audi ceramic' inscription to front callipers	●	●	●	●	£6,079.17	£7,295.00



19" '5-arm double-spoke' design alloy wheels – PQK



19" '5-arm double-spoke' design alloy wheels – PQ7



19" '10-spoke Y' design alloy wheels – PQ1



19" '5-arm rotor' design alloy wheels – PQU

Options are subject to availability and may extend delivery.

– = Not available
● = Available
S = Standard

RRP – Recommended Retail Price.

All prices are subject to VAT at 20% reflecting the VAT rate most likely to be in force at the time of delivery. The VAT rate may change if the vehicle is delivered before 4 January 2011 or if the VAT rate subsequently changes.



Audio and communication

Stay in touch using our range of communication functions, and give each journey its own soundtrack with our advanced audio equipment.

Options are subject to availability and may extend delivery.

- = Not available
 • = Available
 S = Standard

RRP – Recommended Retail Price.

All prices are subject to VAT at 20% reflecting the VAT rate most likely to be in force at the time of delivery. The VAT rate may change if the vehicle is delivered before 4 January 2011 or if the VAT rate subsequently changes.

Order Code		V8 Coupé	V10 Coupé	V8 Spyder	V10 Spyder	Basic RRP	Total RRP inc VAT
9VK	Bang & Olufsen sound system. Designed specifically for the Audi R8, providing surround sound reproduction with dynamic compensation for road noise, digital amplifier and 12 high-performance loudspeakers (total output 465 Watts)	•	S	•	S	£1,020.83	£1,225.00
PT1	Mobile telephone preparation – Bluetooth interface and voice control with integrated seat-belt microphones. Provides handsfree connection via Bluetooth using mobile phone aerial. Please contact your Audi Centre for phone compatibility	•	•	S	S	£237.50	£285.00
PT2	Mobile telephone preparation – Low, Bluetooth interface and voice control with integrated seat-belt microphones. Provides handsfree connection via Bluetooth using mobile phone aerial. Alternatively it can use a cradle with charging facility for optimal reception via external aerial. Cradle available at extra cost – please contact your Audi Centre for phone compatibility. Located in storage compartment on centre console.	•	•	-	-	£358.33	£430.00
		-	-	•	•	£154.17	£185.00
PNA	Satellite Navigation system – DVD-based. Route planning and guidance using voice, pictogram and map. Includes AM/FM tuner with TP memo function. Single front-loading CD player with MP3 compatibility. Includes AUX-IN socket, MMI operating logic and 6.5-inch colour monitor with bird's-eye map display. Two integrated MMC/SD card slots for playing MP3 files, European coverage navigation DVD and dynamic route guidance via TMC. CD changer or AMI is recommended with this option. Audio or MP3-compatible CD player (cannot be used at same time as navigation system)	•	S	•	S	£1,533.33	£1,840.00
UF7 7A0	Audi Music Interface (AMI). Universal connection for use with stereo audio sources, USB and MP3 devices including Apple iPod generation 4 onwards (iPod, iPod classic, iPod mini, iPod nano, iPod photo, iPod video, iPod touch). Provides intuitive control through the audio system and multi-function steering wheel. It also replicates the iPod display on the audio screen and DIS, including track titles. The interface provides charging function (dependent on device). Only in combination with Satellite Navigation system – DVD-based	•	-	•	-	£212.50	£255.00
		-	•	-	•	No charge	No charge
7A2	CD changer. For six CDs, integrated into rear shelf between seats. Cannot be combined with Audi Music Interface	•	S	•	S	£270.83	£325.00



Bang & Olufsen sound system



CD changer



Mobile telephone preparation – Low



Satellite Navigation system – DVD-based



Interior equipment

Specify every detail of your car's interior with this range of options.

Options are subject to availability and may extend delivery.

- = Not available
• = Available
S = Standard

*HomeLink® is a registered trademark of Johnson Controls. For information on compatibility, visit www.homelink.com.

RRP – Recommended Retail Price.

All prices are subject to VAT at 20% reflecting the VAT rate most likely to be in force at the time of delivery. The VAT rate may change if the vehicle is delivered before 4 January 2011 or if the VAT rate subsequently changes.

Order Code		V8 Coupé	V10 Coupé	V8 Spyder	V10 Spyder	Basic RRP	Total RRP inc VAT
6NN	Alcantara headlining. Available in Black, Pale grey or Luxor beige	•	•	-	-	£937.50	£1,125.00
7M7	Carbon sigma door sill trims with aluminium insert and R8 badge	•	•	•	•	£979.17	£1,175.00
YVY S3G	Carbon sigma door sill trims with illuminated aluminium inserts	•	•	•	•	£1,404.17	£1,685.00
7M9	Illuminated door sill trims with aluminium insert and R8 badge	•	•	•	•	£533.33	£640.00
NM5	Carbon sigma engine bay trim. Includes light package on V8 Coupé	•	-	-	-	£2,341.67	£2,810.00
		-	•	-	-	£1,975.00	£2,370.00
8T2	Cruise control. For holding any speed above 25mph	•	•	•	•	£183.33	£220.00
VC1	Garage door opener (Homelink®*). Programmable radio-operated remote control for compatible doors/gates. Control buttons integrated in the front roof module	•	•	•	•	£170.83	£205.00
6Q2	Leather gear knob	•	•	•	•	No charge	No charge



Engine bay in carbon sigma



Homelink®

Interior equipment

Order Code		V8 Coupé	V10 Coupé	V8 Spyder	V10 Spyder	Basic RRP	Total RRP inc VAT
6XK 4L6	Light and rain sensor package. Includes auto-dimming rear-view mirror and door mirrors, automatic headlight activation, automatic windscreen wipers. Also includes electrically folding door mirrors	●	S	●	S	£404.17	£485.00
PAM	Light package. Includes auto-dimming rear-view mirror, light and rain sensors and LED lights illuminating footwell (and engine compartment on Coupé)	●	S	●	S	£366.67	£440.00
GS3	Stainless steel pedals with black rubber inserts	●	S	●	S	£212.50	£255.00
QE1	Storage package. Comprising storage nets on front-seat backrests, storage compartment under the front seats and luggage net. Under-seat storage compartment not available with electric seats or bucket seats	●	●	●	●	£162.50	£195.00

Options are subject to availability and may extend delivery.

- = Not available
- = Available
- S = Standard

RRP – Recommended Retail Price.

All prices are subject to VAT at 20% reflecting the VAT rate most likely to be in force at the time of delivery. The VAT rate may change if the vehicle is delivered before 4 January 2011 or if the VAT rate subsequently changes.



Luggage sets

Audi exclusive

R8 luggage sets are available in finest-grade leather in the specified seat-colour and featuring the R8 logo. The carbon handles, Nardia lining and various contrasting seams make these case sets true collectors' items. Contrasting seams on the outside of the Nardia lining match the colour of the dashboard seams. If interior equipment codes JN and JW are specified, the contrasting seams are in Pale grey.

Options are subject to availability and may extend delivery.

- = Not available
- = Available
- S = Standard

RRP – Recommended Retail Price.

All prices are subject to VAT at 20% reflecting the VAT rate most likely to be in force at the time of delivery. The VAT rate may change if the vehicle is delivered before 4 January 2011 or if the VAT rate subsequently changes.

Order Code		V8 Coupé	V10 Coupé	V8 Spyder	V10 Spyder	Basic RRP	Total RRP inc VAT
YQQ S3G	Two-piece R8 luggage set in Fine Nappa leather. Tailored to fit behind the seats of the R8. Consists of two suitcases in black leather	•	•	-	-	£1,658.33	£1,990.00
YQR S3G	Two-piece R8 luggage set. As above in Audi exclusive leather with contrast stitching	•	•	-	-	£2,083.33	£2,500.00
YQT S3G	Five-piece R8 luggage set. Tailored for the R8 luggage compartment. Includes one suitcase, one briefcase, one suit carrier and two toiletry bags	•	•	•	•	£3,191.67	£3,830.00
YQU S3G	Five-piece R8 luggage set. As above in Audi exclusive leather with contrast stitching	•	•	•	•	£4,000.00	£4,800.00



Five-piece R8 luggage set

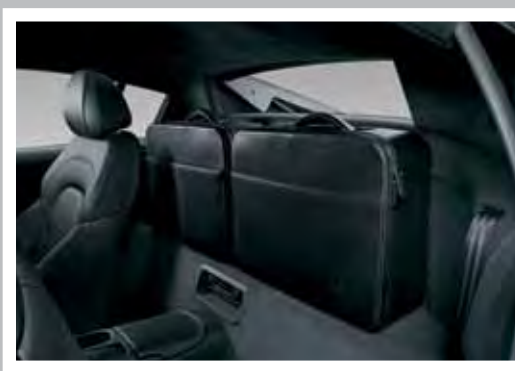

R8 luggage set



R8 luggage set



Seats

Choose from a variety of different seat options so you can maintain the right driving posture at all times.

Order Code		V8 Coupé	V10 Coupé	V8 Spyder	V10 Spyder	Basic RRP	Total RRP inc VAT
4A3	Heated front seats. Individually controlled variable temperature adjustment	●	S	S	S	£233.33	£280.00
PV1	Electrically adjustable front seats. Includes adjustment for height, forwards and backwards position, backrest angle and lumbar support	●	S	S	S	£708.33	£850.00

Audi exclusive bucket seats

Order Code		V8 Coupé	V10 Coupé	V8 Spyder	V10 Spyder	Basic RRP	Total RRP inc VAT
PS5	Audi exclusive front bucket seats in black Fine Nappa leather. Includes electric lumbar-support adjustment, width-adjustment for the seat surface and backrest, manually adjusted longitudinal positioning of seat height and backrest angle	●	●	●	●	£2,041.67	£2,450.00
PYI PS5 S3G	Audi exclusive package 1 in Fine Nappa leather/Alcantara with bucket seats. Includes all the contents of leather package 1 (PYC/S3G, shown on page 36) plus: leather-covered front bucket seats	●	●	–	–	£3,704.17	£4,445.00
PYA PS5 S3G	Audi exclusive leather package 1 in Fine Nappa leather with bucket seats. Includes all the contents of leather package 1 (PYA/S3G, shown on page 36) plus: leather-covered front bucket seats	●	●	–	–	£3,912.50	£4,695.00
PYD PS5 S3G	Audi exclusive leather package 2 in Fine Nappa leather with bucket seats. Includes all the contents of leather package 2 (PYD/S3G, shown on page 36) plus leather-covered front bucket seats. Seat side trims come in Black	●	●	–	–	£6,079.17	£7,295.00

Options are subject to availability and may extend delivery.

– = Not available
● = Available
S = Standard

RRP – Recommended Retail Price.

All prices are subject to VAT at 20% reflecting the VAT rate most likely to be in force at the time of delivery. The VAT rate may change if the vehicle is delivered before 4 January 2011 or if the VAT rate subsequently changes.

Exterior equipment

Make sure your car looks exactly as you want it to by selecting some of our striking options.

Order Code		V8 Coupé	V10 Coupé	V8 Spyder	V10 Spyder	Basic RRP	Total RRP inc VAT
8N7	High-beam assist. Automatically adjusts headlights from high-beam to dipped-beam when another vehicle is approaching. Only in combination with light and rain sensor pack	●	●	●	●	£83.33	£100.00
8EX	All-LED headlights. The world's first headlight unit to use LEDs for all front lighting functions. Total of 54 LED light sources in each headlight provide lower energy consumption and enhanced contrast, giving an effect similar to daylight	●	S	●	S	£2,383.33	£2,860.00
6FQ	Carbon sigma door mirror trims	●	●	●	●	£1,000.00	£1,200.00
PQE	Black styling package. Radiator grille-frame in highly polished black, with radiator grille and number plate holder in matt black and black trimmed exhaust tailpipes. Only available on Coupé	●	●	—	—	£383.33	£460.00



Safety and security

Intelligent technology designed to give you better all-round awareness and safety on the road.

Order Code		V8 Coupé	V10 Coupé	V8 Spyder	V10 Spyder	Basic RRP	Total RRP inc VAT
7X2	Acoustic parking system (front and rear). Aids parking by acoustically indicating distances to obstacles	●	●	●	●	£533.33	£640.00
7X8	Audi parking system advanced. Aids parking by acoustically and visually indicating distances to obstacles with guiding lines. Measured by sensors and reversing camera	●	●	●	●	£1,062.50	£1,275.00
7X4	Audi parking system plus. Aids parking by acoustically and visually indicating distances to obstacles	●	●	●	●	£866.67	£1,040.00
UG1	Audi hill-hold assist. Prevents roll-back on hills for up to 5 seconds by maintaining brake force. Recommended with R tronic® models	●	S	●	S	£66.67	£80.00
—	CobraTrak 5. Thatcham Category 5 approved tracking device that provides the highest level of vehicle security. CobraTrak 5 uses GPS and GSM technology to provide seamless tracking and recovery across 36 European countries. Also includes Automatic Driver Recognition cards and remote engine immobilisation. Please note that this option is a Centre-fitted accessory and needs to be ordered and fitted by your Audi Centre (ZGB420054999A). Price shown includes one year's subscription to the CobraTrak service but excludes fitting	●	●	●	●	£723.40	£850.00
7K7	Tyre pressure monitoring system. Monitors tyres based on air pressures specified by the driver and programmed into the Driver's Information System	●	S	●	S	£229.17	£275.00

Steering wheels

Order Code		V8 Coupé	V10 Coupé	V8 Spyder	V10 Spyder	Basic RRP	Total RRP inc VAT
2PF	Contoured 3-spoke leather Sports flat-bottomed multi-function steering wheel	—	●	—	●	£295.83	£355.00
2PK	Contoured 3-spoke leather Sports flat-bottomed multi-function steering wheel with gearshift paddles (R tronic® only)	—	●	—	●	£295.83	£355.00

Options are subject to availability and may extend delivery.

— = Not available
● = Available
S = Standard

RRP – Recommended Retail Price.

All prices are subject to VAT at 20% reflecting the VAT rate most likely to be in force at the time of delivery. The VAT rate may change if the vehicle is delivered before 4 January 2011 or if the VAT rate subsequently changes.

Service Plan

Choosing an Audi Service Plan provides an easy way to cover all your car's scheduled servicing with a convenient monthly payment plan. It can take care of everything from fluid and filter changes to your full service, ensuring you retain a full Audi service history. There are no servicing bills to plan for and you'll continue to benefit from today's prices for the length of your agreement.

Order Code		V8 Coupé	V10 Coupé	V8 Spyder	V10 Spyder	Basic RRP	Total RRP inc VAT
-	3-Service Plan. Comprehensive package covering servicing costs for 3 services or 30,000 miles (whichever occurs sooner). Visit audi.co.uk/serviceplans for full details including terms and conditions	●	●	●	●	£37.50	£45.00
-	5-Service Plan. Comprehensive package covering servicing costs for 5 services or 50,000 miles (whichever occurs sooner). Visit audi.co.uk/serviceplans for full details including terms and conditions	●	●	●	●	£45.83	£55.00

Warranty

Options are subject to availability and may extend delivery.

- = Not available
● = Available
S = Standard

*Prices are based on the Audi Fixed Inspection Service Schedule and 10,000 miles per annum or less. For more information on the Service Schedule, please see page 60.

**Only available when ordering your new R8. Please speak to your Audi Centre for full details.

RRP – Recommended Retail Price.

All prices are subject to VAT at 20% reflecting the VAT rate most likely to be in force at the time of delivery. The VAT rate may change if the vehicle is delivered before 4 January 2011 or if the VAT rate subsequently changes.

Order Code		V8 Coupé	V10 Coupé	V8 Spyder	V10 Spyder	Basic RRP	Total RRP inc VAT
-	Audi Warranty, covering you for unlimited mileage in the first two years of ownership, and up to 60,000 miles in the third year. Transferable between owners**	S	S	S	S	No charge	No charge
EA6	Audi Warranty, covering you for up to 4 years or 75,000 miles, whichever comes soonest. Cover includes a two-year unlimited mileage warranty, and up to 75,000 miles in the third and fourth years. Transferable between owners**	●	●	●	●	£862.50	£1,035.00
EA9	Audi Warranty, covering you for up to 5 years or 90,000 miles, whichever comes soonest. Cover includes a two-year unlimited mileage warranty, and up to 90,000 miles in the third, fourth and fifth years. Transferable between owners**	●	●	●	●	£2,129.17	£2,555.00

Merchandise

From the enthusiasts' motorsport collection to the sophisticated Audi collection, there's a wide variety of adults' and children's clothing, lifestyle accessories and collectables, all of which bear the Audi name.

Please speak to a member of our team at your local Audi Centre to see the full Audi collection and to place an order. A selection of Audi merchandise is also available to buy from audi.co.uk/merchandise.



Audi kids



Bags and leather goods



Clothing



Motorsports



Sport and travel



Model cars



R8

technical data

Engine	Coupé				Spyder			
	4.2 FSI quattro	4.2 FSI quattro	5.2 FSI quattro	5.2 FSI quattro	4.2 FSI quattro	4.2 FSI quattro	5.2 FSI quattro	5.2 FSI quattro
Transmission	6-speed manual	R tronic sequential manual	6-speed manual	R tronic sequential manual	6-speed manual	R tronic sequential manual	6-speed manual	R tronic sequential manual
Cylinder	V8	V8	V10	V10	V8	V8	V10	V10
Displacement, cubic cm (valves per cylinder)	4163 (4)	4163 (4)	5204 (4)	5204 (4)	4163 (4)	4163 (4)	5204 (4)	5204 (4)
Max. power ¹ , PS	430/7900	430/7900	525/8000	525/8000	430/7900	430/7900	525/8000	525/8000
Max. torque, Nm at rpm	430 (4500 - 6000)	430 (4500 - 6000)	530 (6500)	530 (6500)	430 (4500 - 6000)	430 (4500 - 6000)	530 (6500)	530 (6500)
0-62mph acceleration, seconds	4.6	4.6	3.9	3.9	4.8	4.8	4.1	4.1
CO ₂ emissions ² , g/km	332	310	346	326	337	315	349	332
Top speed ³ , mph	187	187	197	197	186	186	194	194
Benefit in kind (BIK) %	35%	35%	35%	35%	35%	35%	35%	35%
Fuel consumption, mpg (l/100km) Urban	13.3 (21.3)	14.1 (20.1)	12.7 (22.2)	13.4 (21.1)	13.3 (21.3)	14.1 (20.1)	12.7 (22.2)	13.1 (21.5)
Fuel consumption, mpg (l/100km) Extra Urban	28.2 (10.0)	30.1 (9.4)	26.6 (10.6)	28.5 (9.9)	27.4 (10.3)	29.4 (9.6)	26.4 (10.7)	27.7 (10.2)
Fuel consumption, mpg (l/100km) Combined	19.9 (14.2)	21.2 (13.3)	19.0 (14.9)	20.3 (13.9)	19.6 (14.4)	20.9 (13.5)	19.0 (14.9)	19.9 (14.2)
ABI insurance group, 1-50 ⁺	49 E	49 E	50 E	50 E	50 E	50 E	50 E	50 E
Unladen weight ⁴ , kg	1560	1565	1620	1625	1660	1665	1720	1725
Gross weight limit, kg	1860	1865	1920	1925	1960	1965	2020	2025
Luggage compartment capacity, rear seats upright, litres	100	100	100	100	100	100	100	100
Fuel tank capacity approx, litres	90	90	90	90	80	80	80	80

¹Highest insurance group rating shown. Group may be lower dependent on trim level. Please visit www.thatcham.org/abigrouprating for details.

²The given value was obtained in accordance with the specified measurement procedure (the respective current version of the Directive 80/1269/EEC).

³The given values were calculated in accordance with the specified measurement procedure (the respective current version of Directive 80/1268/EEC). This information does not relate to a single vehicle and does not comprise part of the offer but is merely intended for the purpose of comparison between the different vehicle types.

⁴Top speed is achieved in sixth gear.

⁵Vehicle's unladen weight without driver (calculated in accordance with the current version of Directive 80/1268/EEC). The fitting of additional equipment may increase the vehicle's unladen weight and drag coefficient, whereupon the potential carrying capacity and top speed will be correspondingly reduced.



R8 V8 Coupé dimensions

The technical drawings opposite show the exact dimensions of the R8 V8 Coupé, so you can check everything from the ground clearance to the length of the car.

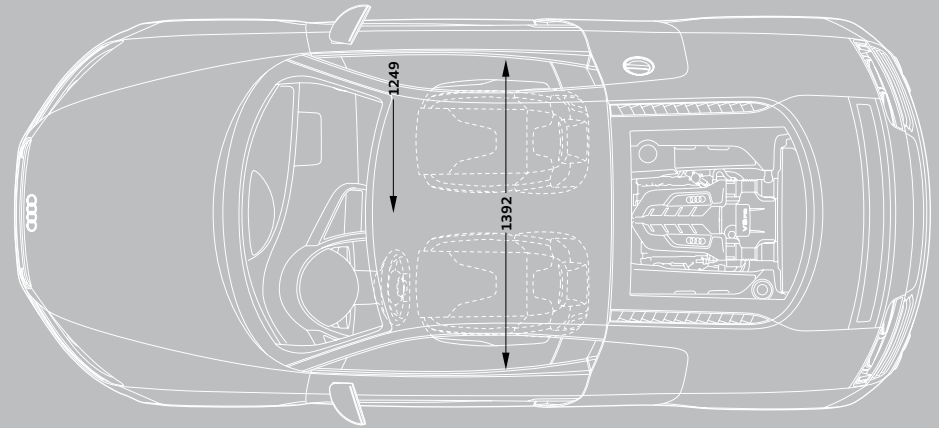
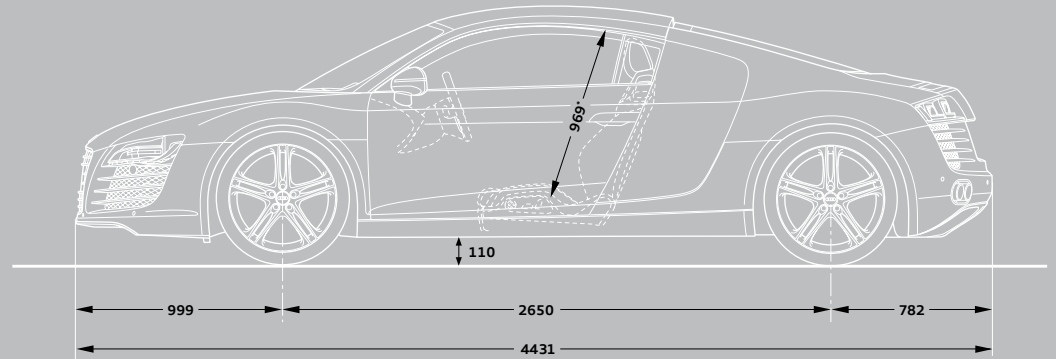
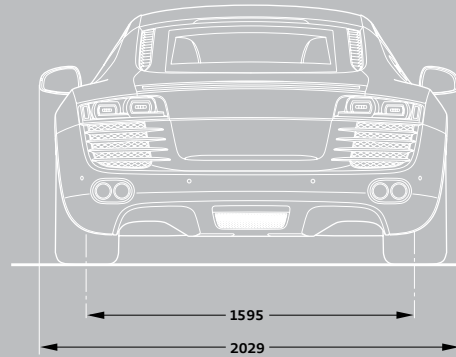
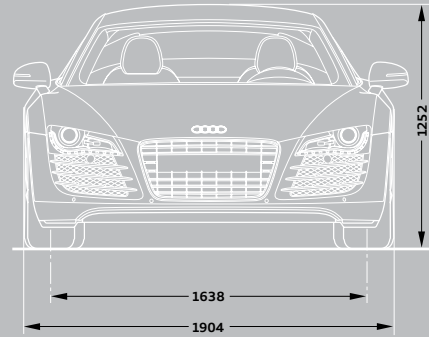

Dimensions were measured with vehicle at unladen weight, ground clearance measured with vehicle carrying its maximum load.

Turning circle approx 11.4m.

Dimensions in millimetres.

R8 V10 Coupé dimensions

The technical drawings opposite show the exact dimensions of the R8 V10 Coupé, so you can check everything from the ground clearance to the length of the car.

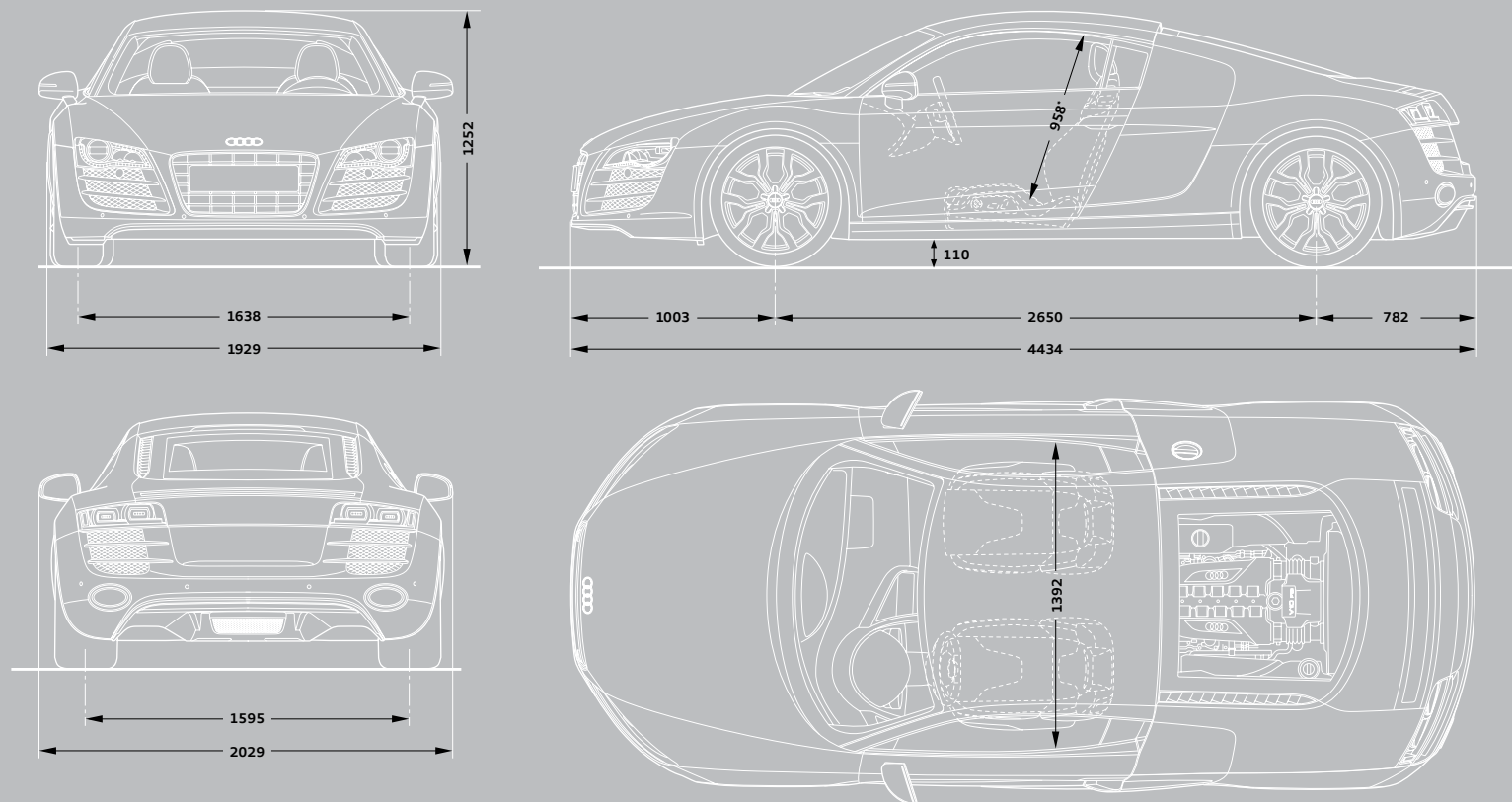

Dimensions were measured with vehicle at unladen weight, ground clearance measured with vehicle carrying its maximum load.

Turning circle approx 11.4m.

Dimensions in millimetres.

R8 V8 Spyder dimensions

The technical drawings opposite show the exact dimensions of the R8 V8 Spyder, so you can check everything from the ground clearance to the length of the car.

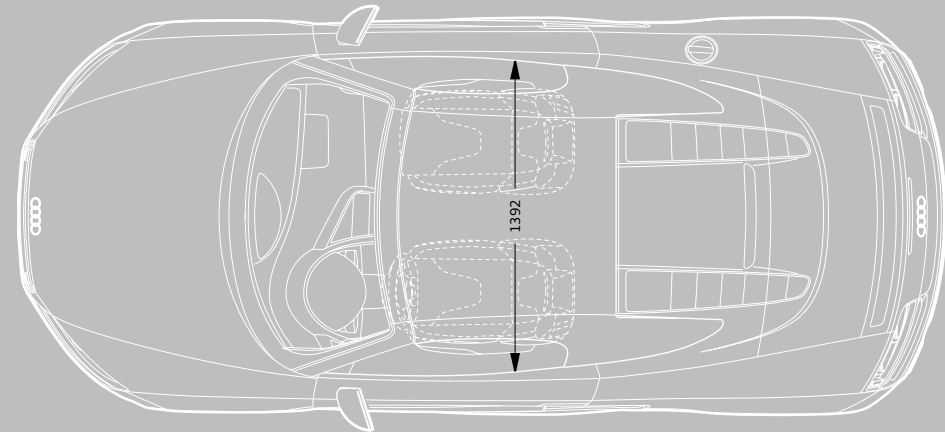
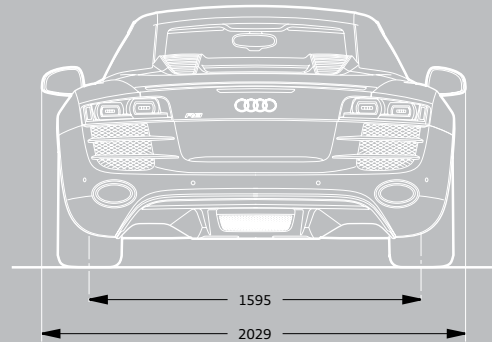
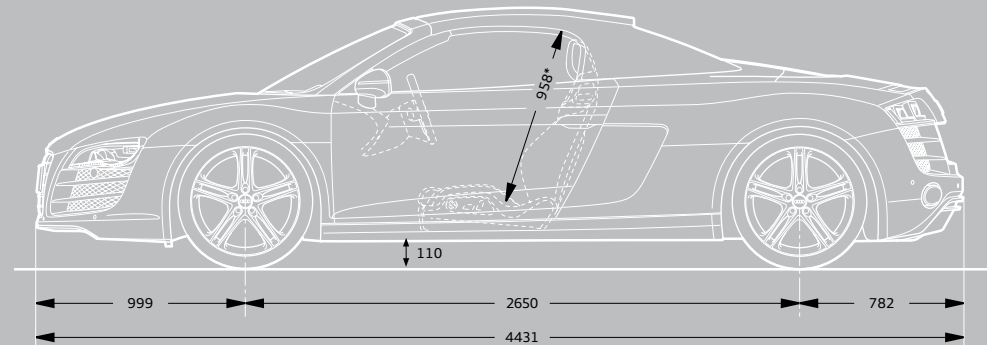
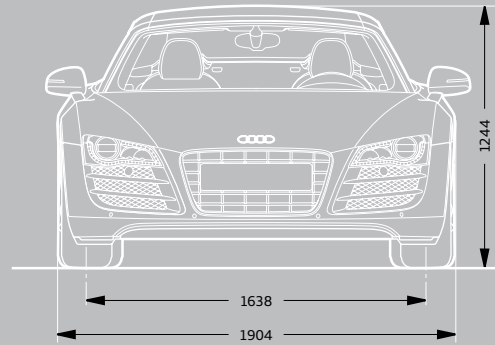

Dimensions were measured with vehicle at unladen weight, ground clearance measured with vehicle carrying its maximum load.

Turning circle approx 11.4m.

Dimensions in millimetres.

R8 V10 Spyder dimensions

The technical drawings opposite show the exact dimensions of the R8 V10 Spyder, so you can check everything from the ground clearance to the length of the car.

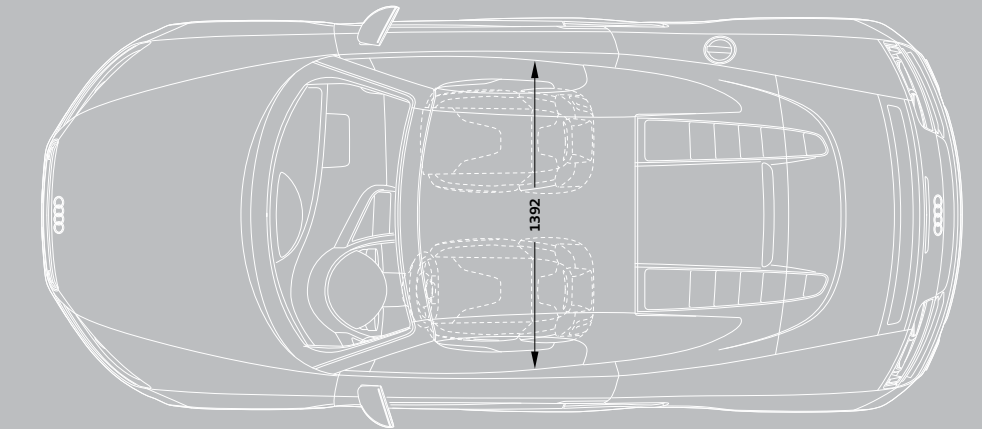
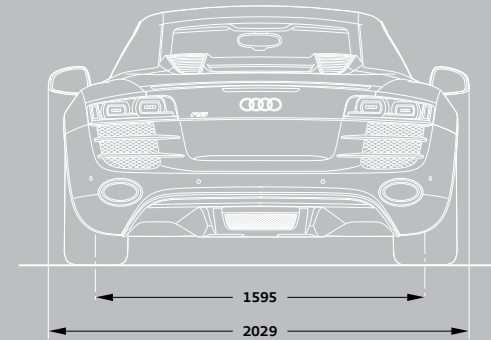
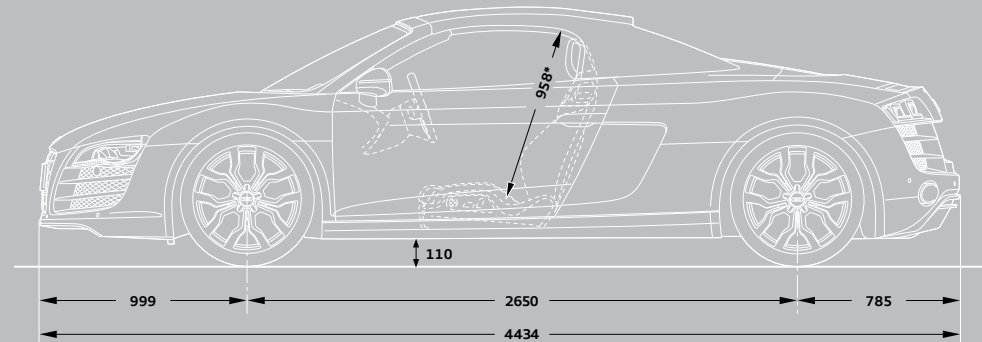
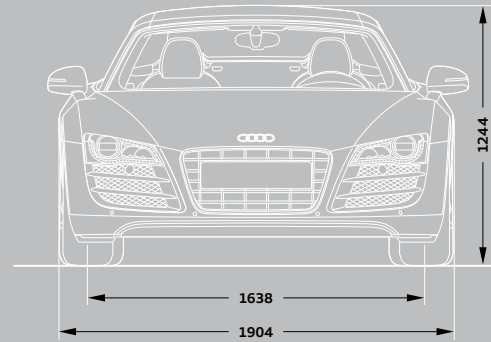

Dimensions were measured with vehicle at unladen weight, ground clearance measured with vehicle carrying its maximum load.

Turning circle approx 11.4m.

Dimensions in millimetres.

Additional information

CO₂ data and information

CO₂ emissions-based Vehicle Excise Duty

Vehicle Excise Duty (Road Fund Licence) is based upon the amount of Carbon Dioxide (CO₂) a vehicle emits, measured in grams per kilometre (g/km). The DVLA has created thirteen categories:

Petrol and Diesel engines

A - up to 100g/km	£0.00
B - 101 to 110g/km	£0.00
C - 111 to 120g/km	£0.00
D - 121 to 130g/km	£0.00
E - 131 to 140g/km	£110.00
F - 141 to 150g/km	£125.00
G - 151 to 165g/km	£155.00
H - 166 to 175g/km	£250.00
I - 176 to 185g/km	£300.00
J - 186 to 200g/km	£425.00
K - 201 to 225g/km	£550.00
L - 226 to 255g/km	£750.00
M - over 255g/km	£950.00

Vehicle Excise Duty (VED) rates correct at time of going to print, but these may alter to reflect any change in the applicable VED rate

Servicing tailored to your needs

Regular servicing is key to safeguarding your Audi's performance and a full Audi service history could help you preserve the future re-sale value. To make servicing easy, the Audi Service Schedules have been designed to work with your individual driving style and vehicle.

There are two schedules available and your Audi Centre will advise which schedule is most suited to your needs. The conventional fixed Audi Inspection Service Schedule has fixed intervals for the Oil-change and Inspection Service that are based on time

and distance, whichever comes first. With the Audi LongLife Service Schedule, sensors take account of driving style and conditions in which the vehicle is used to indicate when the Oil-change Service is required. Oil-change Service intervals are therefore variable and are conveniently indicated via the on-board service interval display.

Fixed Inspection Service Schedule

	Vehicle usage:
Mileage	Less than 10,000 miles per annum
Type of journey	Mainly city/town centre driving. Short journeys
Conditions	Frequent cold starts. High engine loading – e.g. frequent hill climbs, vehicle fully loaded, towing
Driving style	Uneconomical – e.g. heavy acceleration, heavy braking, constant changes in speed, constant use of high revs, 'sporty' driving
	Service Intervals:
Oil-change Service	Fixed to every 9,000* miles/1 year
Inspection Service	Fixed to every 19,000* miles/2 years

Variable LongLife Service Schedule

	Vehicle usage:
Mileage	More than 10,000 miles per annum
Type of journey	Motorway and main road driving. Mainly longer distance journeys. Constant speeds
Conditions	Normal engine loading – e.g. with little or no towing, with little or no hill climbs. Normal vehicle loading
Driving style	Moderate acceleration, moderate braking, engine revs mainly below 3,000
	Service Intervals:
Oil-change Service	Variable to a maximum of every 19,000* miles/2 years
Inspection Service	Fixed to every 19,000* miles/2 years

*As indicated by the service interval display. Mileages are approximate as the Service Indicator system uses kilometres as its distance measurement.

Additional information

Welcome to Audi

By placing an order for your Audi, you're choosing to get behind the wheel of one of the most sophisticated cars on the road. And because we believe the service we offer should be just as advanced, we wanted to let you know exactly what you can expect from us, now and in the future.

We've agreed a set of standards with all our Centres, which governs the way we do business with you. It outlines the kind of service we promise to deliver for every customer, right down to filling each new Audi we sell with half a tank of fuel.

So whether you're interested in the date your car will arrive in the UK or the way we'll dispose of non-biodegradable materials after we service your Audi, you can have total confidence in us.

Audi Promise

Audi Centres

We guarantee that all of our Centres will be open as follows;

Sales: Monday to Friday 9am–6pm
Saturday 9am–5pm

Service: Monday to Friday 8am–6pm
Saturday 8.30am–1pm

Sunday opening is at local discretion.

New car delivery

Once we've confirmed a delivery date for your car, we'll keep you informed of progress. Subject to reasonable notice, we'll then deliver it to a place of your choice, whether that's your home or place of work. In the unlikely event of a delay, we'll provide a courtesy car to minimise inconvenience and keep you mobile.

The experts in Vorsprung durch Technik

Would you entrust your Audi to anyone who hasn't been regularly trained to Audi standards? Our network of Audi Approved Master Technicians have undergone an impressive 100,000 hours of training over a 10-year programme to ensure they have the latest technical expertise for maintaining and servicing your Audi. All of our Service Advisors undergo a specialist induction and training to ensure they are Audi professionals and able to talk to you about any issues you may have with your Audi vehicle. What's more, we have so much expertise and experience in looking after Audi vehicles that we are able to make a note of your mileage and the state of your vehicle as and when we see it and predict when certain key events may occur. As part of our duty of care, we will notify you in plenty of time so you can make an appointment with us.

Your convenience comes first

At Audi you can choose from a range of convenient services that suit your needs. Why not book a 'service while you wait' appointment* and enjoy our complimentary refreshments while your car is with us? Or, if you need to be mobile, take advantage of one of our courtesy cars which we can even collect and deliver to you.* We guarantee we can service your Audi within 5 days without a courtesy car, or within 10 days if you need transport. We will also ensure your car is returned to you with a full valet.

Audi Genuine Parts

Would you put a part into your Audi that wasn't the same quality as the factory-fitted original? You can rest assured that only Audi Genuine Parts will be used on your vehicle. What's more, Audi parts and labour come with a 2-year guarantee.** We stock a wide variety of parts, so we are well covered. However, if we don't have a part in stock at our Centre we have the back-up of parts at other Audi Centres, at our national warehouse and our factory and can usually source the relevant part very quickly.

We don't like surprises either

We believe strongly in transparency and there will be no hidden costs. For added peace of mind, we will give you a quotation over the phone for the work you have requested and email you the price confirmation. We'll consult you if any additional work on your car is needed when it is with us. We won't carry out any extra work without asking your permission first.

The Audi Stamp

Regular servicing is key to safeguarding your Audi's performance and a full Audi service history could help you preserve the future re-sale value of your car. Only the Audi Stamp will prove your approved Audi service history.

Getting better every time

We continually gather feedback from our Audi Trained Technicians, as well as our customers, to ensure our vehicles are running as they should. Whenever we see an Audi for a service, we connect it directly to our headquarters in Ingolstadt which enables us to check your car's software and make sure it's as up-to-date as possible. If the factory has released a software upgrade for your model, it can be applied immediately – improving anything from your car's efficiency to the precision of its parking system.

Environmental commitment

We promise to dispose of all non-biodegradable materials from your vehicle in a responsible manner.

*Subject to availability.

**Excludes wear and tear.

Audi UK

Customer Services
Selectapost 29
Sheffield
S97 3FG
0800 699888
audi.co.uk

Specifications and prices subject
to change without notice.

© Audi UK

Printed in the UK
Edition 3.0 10/10
2011 model year

Images are for illustrative purposes only.