



The new Audi RS 5 Coupé

Pricing and Specification Guide
Valid from June 2010

Personalising your Audi RS 5

This guide has been designed to help you tailor and price your Audi RS 5 quickly and logically. At the back, you will also find information on CO₂ emissions-based vehicle excise duty and the other services offered by Audi, including Finance and Insurance. Alternatively, you can go to audi.co.uk and configure your Audi RS 5 online.

The Audi RS 5

Technology	8
Engine	10
Transmission	11

Model details and prices

Standard model equipment	12
Model prices	14

Audi exclusive

Colour and upholstery

Paint	18
Upholstery	20
Colour and trim guide	21
Inlays	24

Options

Wheels and tyres	26
Performance	28
Packages	30
Audio and communication	32
Interior equipment	33
Seats	34
Exterior equipment	35
Safety and security	36
Steering wheels and controls packs	37
Warranty	38
Merchandise	39

Technical details

Technical data	40
Dimensions	41
Additional information	42
Pricing information	44





Vorsprung durch Technik

Three words that express the very essence of Audi. Vorsprung durch Technik isn't a slogan. It's our way of seeing the world. It is the driving force behind our history of innovation that continues into the 21st century. Indeed, many technologies that Audi pioneered remain in our cars today. Some are milestones in the history of the motorcar.

From our beginnings in 1899, to the Auto Union team's Grand Prix successes in the 1930s and our more recent wins at Le Mans, we have always been at the forefront of the motor industry.

Vorsprung durch Technik makes us who we are. To see more of its influence, just read on.

Introducing the new RS 5

The RS story has unfolded over the last fifteen years, delivering a series of elegant yet supremely powerful models – and the RS 5 is no exception. As a direct descendant of our most exciting high-performance models, it's the culmination of the technical expertise we've gained on roads and racetracks all over the world. Our long history of motorsport success is evident throughout the RS 5. Some of the world's toughest races have taught us how to propel our cars ever more powerfully, responsively and efficiently. The RS 5's engine epitomises this knowledge. A close relative of the V10 in the Audi R8, the 4.2 V8 FSI® engine develops 450 horsepower and transmits a maximum of 430 Nm of torque. However, you'll see as you read on, there's much more to the RS 5 than thrilling power and handling – but we think you'll agree that these qualities make an excellent place to start.





Technology

quattro® with Sports differential

Making its debut in the Audi RS 5 is the very latest generation of quattro® permanent all-wheel-drive – the exclusive road-holding technology that’s helped Audi dominate the racetrack ever since 1980. Two decades and many evolutions later, it’s 2.5kg lighter, more compact and now features the brand new crown-gear centre differential – an addition which achieves high locking values for even greater traction. A torque vectoring function also distributes different amounts of driving force to each wheel as necessary. The result: firm traction, precision handling and high lateral stability – no matter what the road conditions.

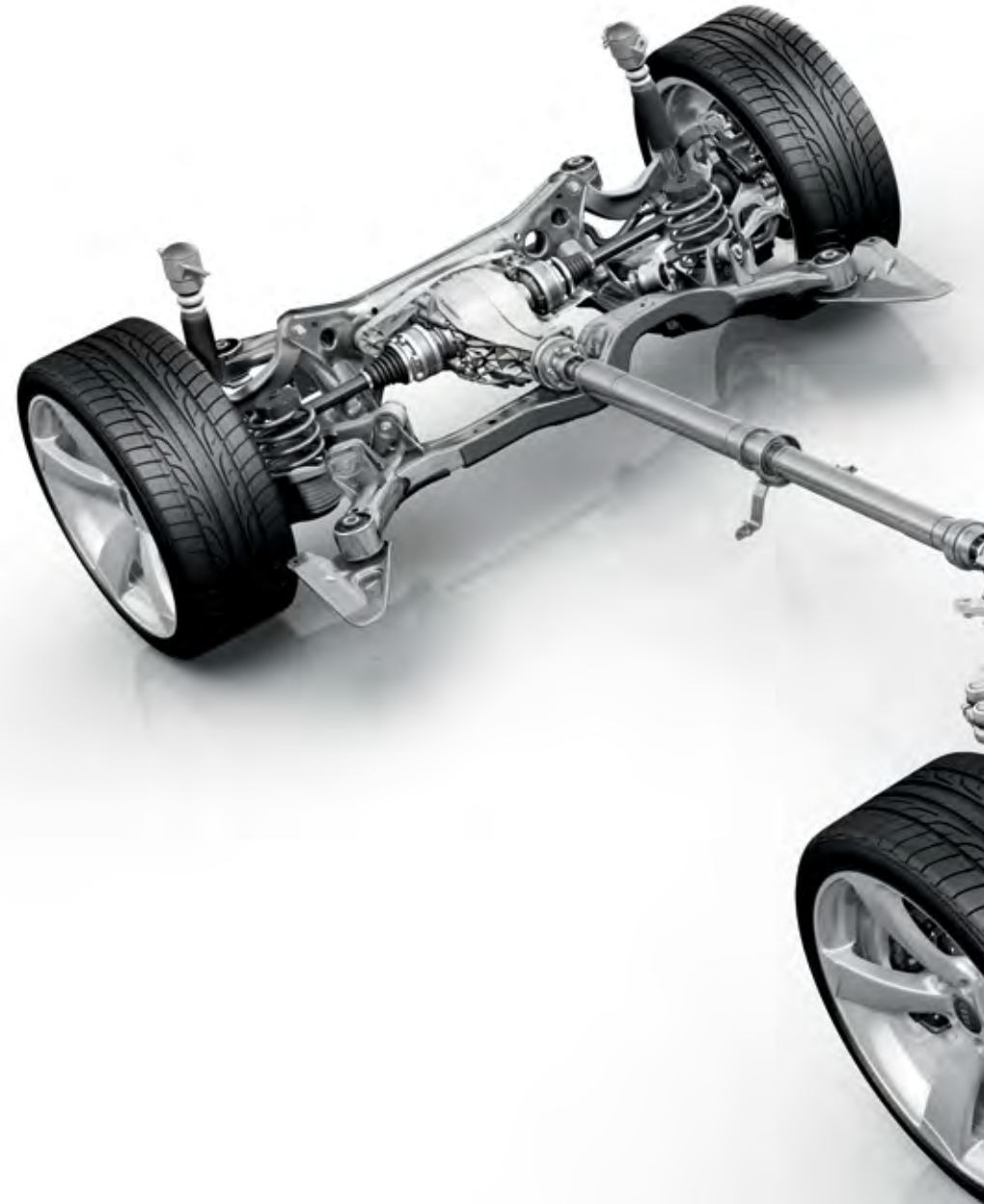



Dynamic Ride Control

Dynamic Ride Control enhances the suspension and stabilises the car using a system of linked, single-tube shock-absorbers and central valves. It's designed to compensate for any excessive body roll and to give you control over your driving experience. Depending on the road surface, traffic density and quite simply, your mood, you can switch between three programmes at the touch of a button.

High-performance braking system

A car as powerful as the RS 5 needs an equally powerful system to slow it down. The high-performance braking system has black, high-gloss 8-piston fixed callipers in the front wheels and single-piston sliding callipers in the rear. The brake discs are internally ventilated, and perforated for enhanced performance. And for even more impressive braking power, there's the option of 19-inch ceramic brakes.

Engine

Petrol

A 4.2-litre V8 FSI® engine is one innovation that sets the RS 5 apart – and keeps it there. That's thanks to our Le Mans-winning fuel-injection technology, which provides enhancements to fuel efficiency, power and torque. But this unit is capable of more than just delivering raw power; it's also adept at using it. Launch control combines both braking and acceleration to give you the quickest possible start, taking the RS 5 from 0 to 62mph in just 4.6 seconds. And once you accelerate, the engine provides consistent power build-up and superb responsiveness across the entire rev range. So when you need to ask for that bit more power, whatever the situation, you can be confident it will deliver.



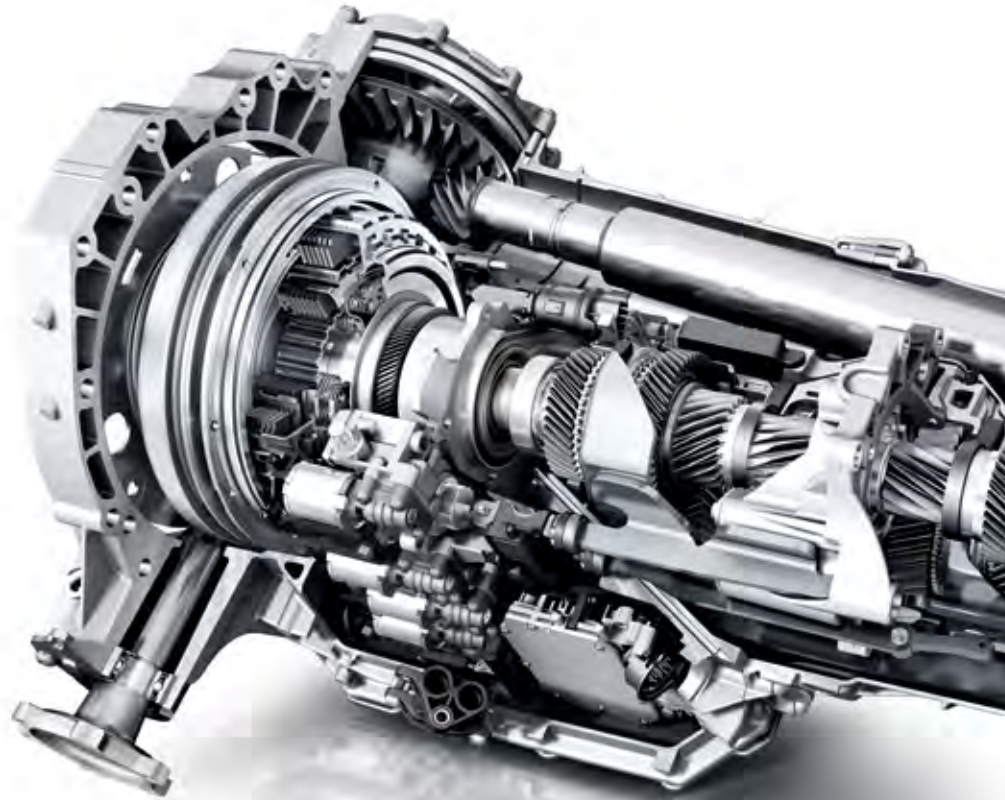

Transmission

S tronic®

Driving is all about thinking ahead, which is just what the S tronic® dual-clutch transmission does. It works almost as two separate systems, one engaging the odd-numbered and the other the even-numbered gears. So when you're accelerating in second, it has third gear waiting for you. And once you make the switch, it's already thinking about fourth. With two clutches working together, you can change gears almost instantly while experiencing smooth, uninterrupted power.

Standard model equipment

All RS 5 models have the following items of standard equipment

The equipment for the Audi RS 5 builds upon the standard equipment for the Audi S5. The typical characteristics of the Audi RS models emphasise the exclusive, dynamic and sporty character of the Audi RS 5. It is unmistakable.

Wheels, tyres and suspension

19" x 9.5J '5-spoke Aero' design alloy wheels with 265/35 R19 tyres and locking wheel bolts

Audi drive select

Dynamic Ride Control (DRC) Sports suspension system with 3 level controls

RS high performance braking system

quattro® with sports differential

Tyre Mobility System

Servotronic speed-related power assisted steering

Safety and security

Audi parking system plus with front and rear sensors

Automatic headlight operation with coming home/leaving home function

Automatic windscreen wipers

Electromechanical parking brake

Electronic Stability Programme (ESP)

First aid kit

Front airbags

Front and rear ISOFIX child seat preparation with front passenger airbag deactivation switch

Front side airbags

Rear fog lights

Sideguard curtain airbags

Thatcham category 1 alarm

Toolkit and car jack

Tyre pressure monitoring system

Warning triangle

Seats

Electric lumbar support for front seats

RS Super Sports seats, electrically adjustable

Silk Nappa leather with contrasting piping and RS embossing

Audio and communication

Audi Concert audio system. Single CD with MP3 compatibility, colour centre console screen, SD memory-card reader and AUX-IN socket in centre console

Audi Sound System speaker package, with 10 speakers including subwoofer (180 Watts)



RS multi-function steering wheel



19" x 9.5J '5-spoke Aero' design alloy wheels

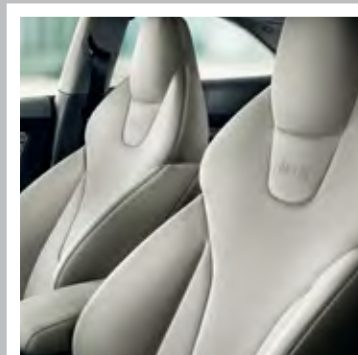

RS Super Sports seats

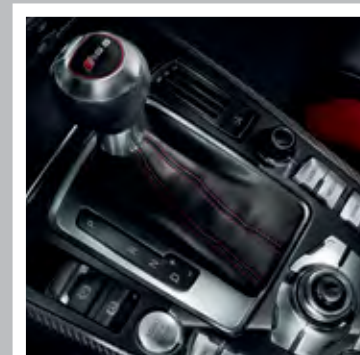

Carbon inlays and MMI controls

Interior equipment

Carbon inlays
 Colour Driver's Information System (DIS)
 Deluxe 3-zone climate control with separate air distribution and digital display for the driver and front passenger. System includes air-conditioning controls in the rear centre console for passenger compartment
 Front centre armrest including 12V power socket
 Interior light package
 RS instrument panel
 RS multi-function steering wheel with aluminium-look gearshift paddles
 Through-load facility with ski/snowboard bag

Exterior equipment

Adaptive light including Xenon headlights, LED daytime running lights, LED rear lights, headlight washer system and automatic range adjust
 Auto-opening boot lid
 Exterior mirrors – electrically operated and heated
 Matt-finished aluminium-look door mirror housings, window trims and grille
 RS body styling
 Speed-activated rear spoiler
 Two oval exhaust pipes



Rear spoiler



Oval exhaust with optional matt aluminium styling package



Unique honeycomb effect grille with RS 5 logo

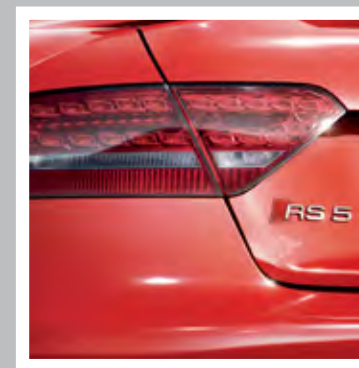

LED rear lights

RS 5 Coupé

Engine	Power	Transmission	Basic RRP	Total RRP inc VAT	Recommended OTR
4.2 FSI quattro	450PS	7-speed S tronic	£47,740.43	£56,095.00	£57,480.00

Please note: The maximum power output figures are quoted in PS (or Pferdestärke, which is the metric equivalent of brake horsepower). To convert to brake horsepower, divide the PS figure by 1.0139.

Recommended On-The-Road (OTR) retail prices include: delivery charge, half a tank of fuel, number plates at £580.00 (inc. VAT), Road Fund Licence (which may vary depending on model/transmission see page 42 for details) and first registration fee at £55.00. Vehicle Excise Duty correct at time of going to print, but this may alter to reflect any change in the applicable VED rate.





Audi exclusive



Audi exclusive

Every Audi is intrinsically exclusive. It's the breathtaking design, the exceptional engineering, the Vorsprung durch Technik. But for that special touch you can specify your new RS 5 with options from Audi exclusive. Whether you want a unique, custom-mixed paint colour or seats in a combination of complementary shades, Audi exclusive will enable you to drive the car you've always imagined.

Both the exclusive and standard options can be found on the following pages.

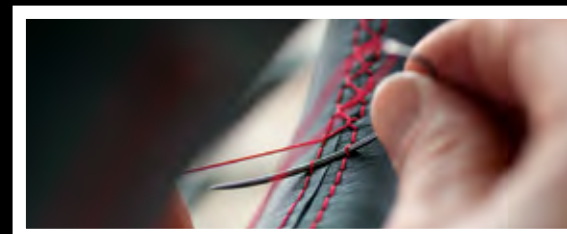
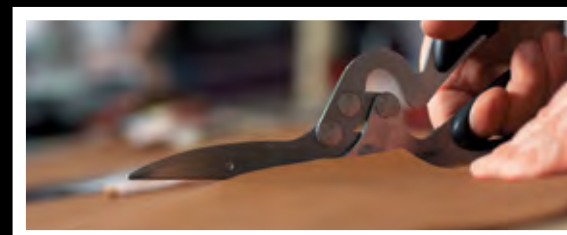

Paint

You can select the standard Ibis white shown opposite or, for a different look, choose from the range of optional finishes.

Standard colour



Ibis white – T9

Optional colours

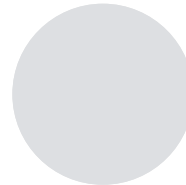

Suzuka grey, metallic – M1

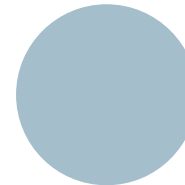

Monza silver, metallic – U7

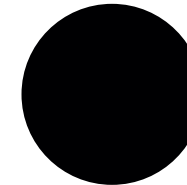

Panther black, crystal effect – H8

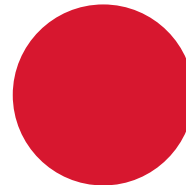

Misano red, pearl effect – N9

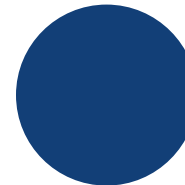

Sepang blue, pearl effect – E9

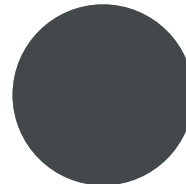

Daytona grey, pearl effect – 6Y

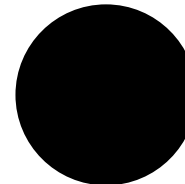

Phantom black, pearl effect – L8

Options are subject to availability and may extend delivery.

All the colour swatches on this page are matched as accurately as possible to the actual paint colours used. However, due to print processes, Audi UK cannot guarantee that colours shown are 100% accurate.

Visit your local Audi Centre for a more accurate colour swatch.

RRP – Recommended Retail Price.

VAT is calculated at 17.5% but this may alter to reflect any change in the applicable VAT rate.

Optional colours

Basic RRP
£510.64

Total RRP inc VAT
£600.00

Paint

Audi exclusive

Everyone has a favourite colour. No matter what yours is, Audi exclusive provides a range of unique colours that have been designed to set your car apart. Choose from the swatches here, or specify any other paint colour in the Audi range – whether it's Jet blue from the Audi R8 or Alpine white from the original Audi quattro®. The choice is yours.

Customised

If you have a particular colour in mind, we'll mix the exact metallic or pearl-effect shade you want.*

Options are subject to availability and may extend delivery.

*Custom paint is subject to factory approval, and is available for metallic and pearl-effect water-based paints only. Three-colour process colours and two-tone schemes are not available.

**Visit your local Audi Centre for colour samples

All the colour swatches on this page are matched as accurately as possible to the actual paint colours used. However, due to print processes, Audi UK cannot guarantee that colours shown are 100% accurate.

RRP – Recommended Retail Price.

VAT is calculated at 17.5% but this may alter to reflect any change in the applicable VAT rate.

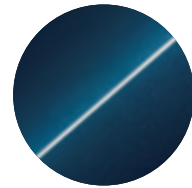

Palace blue, pearl effect

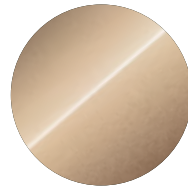

Sand beige, pearl effect

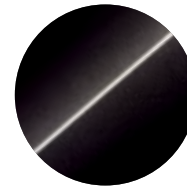

Saddle brown, pearl effect

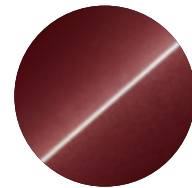

Classic red, pearl effect

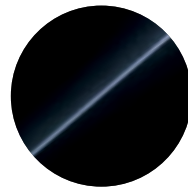

Mamba black, metallic

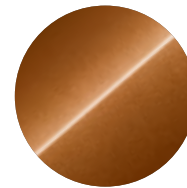

Ipanema brown, metallic



Any colour in the Audi range



100 Audi exclusive colours to choose from**

Audi exclusive
Basic RRP
£1,446.81
Total RRP inc VAT
£1,700.00



Customised paint

Customised
Basic RRP
£2,042.55
Total RRP inc VAT
£2,400.00

Upholstery

RS embossed front Super Sports seats

Choose your favourite upholstery from the swatches shown opposite to give your car's interior the look and feel you want.

You can also order front bucket seats – please see page 34 for details.

Silk Nappa leather

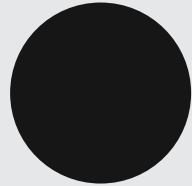

Black with Rock grey piping – **UB/UD**



Pearl silver with Rock grey piping – **UE/UF**

Leather/Alcantara



Black – **QH/SC**

Options are subject to availability and may extend delivery.

- = Not available
- = Available
- S = Standard

RRP – Recommended Retail Price.

VAT is calculated at 17.5% but this may alter to reflect any change in the applicable VAT rate.

RS 5	Basic RRP	Total RRP inc VAT
S	No charge	No charge
•	No charge	No charge

Colour and trim guide

Interior trim colours

RS embossed front Super Sports seats

To help you choose the right interior for your Audi RS 5, please use the guide which shows the carpet, dashboard and headlining colours that have been matched to your chosen upholstery.

Order code	Upholstery	Carpet	Dashboard (upper/lower)	Headlining	Silk Nappa leather	Leather/Alcantara
UB/UD	Black with Rock grey piping	Black	Black	Black/Silver	●	—
UE/UF	Pearl silver with Rock grey piping	Black	Black	Black/Silver	●	—
QH/SC	Black	Black	Black	Black/Silver	—	●

RS embossed front bucket seats

Order code	Upholstery	Carpet	Dashboard (upper/lower)	Headlining	Fine Nappa leather
UB/UD	Black metallic with Rock grey stitching	Black	Black	Black/Silver	●

Options are subject to availability and may extend delivery.

- = Not available
- = Available
- S = Standard

Upholstery

Audi exclusive

With Audi exclusive, you can specify your seats in Valcona leather or Valcona leather/Alcantara, in an array of different colours shown to the right.

Select just one all-over shade for each seat, or customise each panel in two or more complementary colours from the distinctive Audi exclusive palette. You can even choose the colour of the decorative stitching – to match or contrast with your chosen upholstery – from this varied collection. Whatever combination you decide upon, we think you'll be extremely comfortable with the result.

Options are subject to availability and may extend delivery.

– = Not available
• = Available
S = Standard

*Leather and stitching (where applicable) can be specified in a variety of colours from the Audi exclusive range.

RRP – Recommended Retail Price.

VAT is calculated at 17.5% but this may alter to reflect any change in the applicable VAT rate.

Order Code		RS 5	Basic RRP	Total RRP inc VAT
PYC S3G	Audi exclusive leather package 1 in Valcona leather/Alcantara. Includes leather-covered seat side trims, head restraints, front centre armrest and Alcantara door trim inserts and seat centre sections. Backrest covers and seat add-on parts come in the interior trim colour (not in combination with RS bucket seats)*	•	£1,914.89	£2,250.00
PYB S3G	Audi exclusive leather package 1 in Valcona leather. Includes leather-covered seat upholstery, door trim inserts and front centre armrest. Backrest covers and seat add-on parts come in the interior trim colour*	•	£1,914.89	£2,250.00
PYE S3G	Audi exclusive leather package 2 in Valcona leather. Includes all the contents of leather package 1 plus: leather-covered seat backrest covers, door armrests and handles. Seat side trims and add-on parts are colour coordinated (not in combination with RS bucket seats)*	•	£2,510.64	£2,950.00

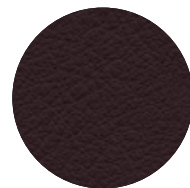

Chestnut brown

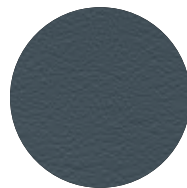

Jet grey



Alabaster white

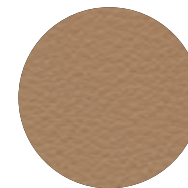

Sand beige

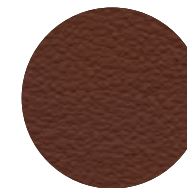

Saddle brown

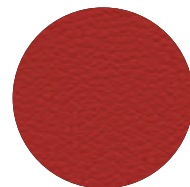

Crimson red

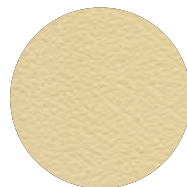

Magnolia white



Havanna brown

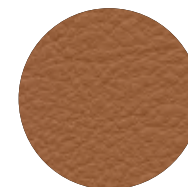

Cognac brown

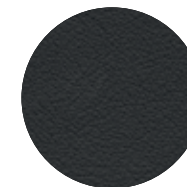

Night blue

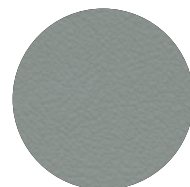

Cloudy grey

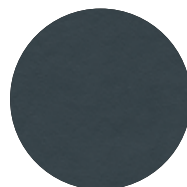

Smoky blue

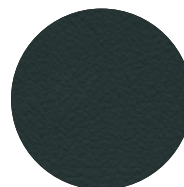

Iceland green

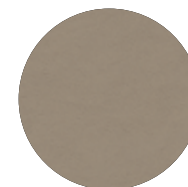

Powder beige



Classic red

Also available:

Alcantara colours: available in all the Audi exclusive colours shown, except for Crimson red, Jet grey and Sand beige. Alcantara equivalents are Chilli red, Amethyst grey, and Sesame beige respectively.

Carpet colours: available in all the Audi exclusive colours shown, except for Crimson red and Saddle brown.

Please consult your Audi Centre for examples of Alcantara and carpet colours.



Inlays

Inlays are the all-important finishing touch that add flair and interest to your car's interior.

Order Code		RS 5	Basic RRP	Total RRP inc VAT
5MB	Carbon	S	No charge	No charge
5TG	Matt-brushed aluminium	●	No charge	No charge
5TL	Piano finish, black	●	No charge	No charge
7TN	Stainless steel dark mesh, centre console in Piano finish, black	●	No charge	No charge

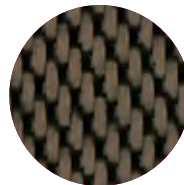

Carbon – **5MB**

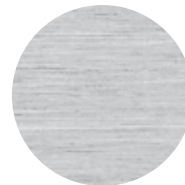

Matt-brushed aluminium – **5TG**

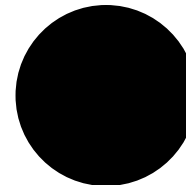

Piano finish, black – **5TL**

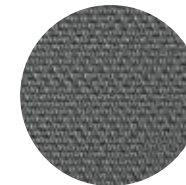

Stainless steel dark mesh – **7TN**

Options are subject to availability and may extend delivery.

- = Not available
- = Available
- S = Standard

RRP – Recommended Retail Price.

VAT is calculated at 17.5% but this may alter to reflect any change in the applicable VAT rate.

Inlays

Audi exclusive

Audi exclusive has sourced a varied range of materials from which to craft these elements. You can even customise your gear knob and steering wheel with one of the available woods, all of which are shown opposite.

Options are subject to availability and may extend delivery.

- = Not available
- = Available
- S = Standard

RRP - Recommended Retail Price.

VAT is calculated at 17.5% but this may alter to reflect any change in the applicable VAT rate.

Order Code		RS 5	Basic RRP	Total RRP inc VAT
YTA S3G	Audi exclusive inlays (cannot be combined with the inlays shown on page 24)	•	£676.60	£795.00



Fine grain maple, copper



Fine grain ash, nougat

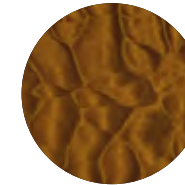

Quilted maple, gold



Poplar, saffron



Oak, sepia

Wheels and tyres

Choose a set of specially-selected alloy wheels to subtly enhance the way your car looks and drives.



19" '5-spoke Aero' design alloy wheels – CR6



20" x 9J '5-arm Rotor' design alloy wheels – PQW



20" x 9J '5-arm Rotor' design Titanium look alloy wheels – PQU

Options are subject to availability and may extend delivery.

Wheels and tyres

Dynamic steering

With this new technology, driving is significantly more agile under everyday conditions, while directional stability and precision are increased at high speeds and in demanding driving situations.

Order Code		RS	Basic RRP	Total RRP inc VAT
CR6	19" '5-spoke Aero' design alloy wheels with 265/35 R19 tyres	S	No charge	No charge
PQW	20" x 9J '5-arm Rotor' design alloy wheels with 275/30 R20 tyres	●	£1,446.81	£1,700.00
PQU	20" x 9J '5-arm Rotor' design Titanium look alloy wheels with 275/30 R20 tyres	●	£1,531.91	£1,800.00
1N7	Dynamic steering	●	£604.26	£710.00

Options are subject to availability and may extend delivery.

- = Not available
- = Available
- S = Standard

RRP – Recommended Retail Price.

VAT is calculated at 17.5% but this may alter to reflect any change in the applicable VAT rate.

Performance

We've developed a whole range of performance options to complement the capabilities of the RS 5 – everything from an increased top speed to a high performance brake system.



Options are subject to availability and may extend delivery.

Performance

Order Code		RS 5	Basic RRP	Total RRP inc VAT
NM5	Carbon design package for engine bay	●	£425.53	£500.00
1LW	Ceramic brakes – front. High performance brake system with carbon-fibre reinforced, vented and perforated ceramic brake discs. Brake callipers in 'Anthracite' with 'Audi ceramic' logo on front	●	£5,319.15	£6,250.00
OP6	Sports exhaust. Oval shaped dual exhaust pipes in matt black which subtly alter the sound of the RS 5 engine	●	£740.43	£870.00
6Y9	Top speed restrictor increase to 174mph*	●	£1,259.57	£1,480.00

Options are subject to availability and may extend delivery.

*Where law permits

- = Not available

● = Available

S = Standard

RRP – Recommended Retail Price.

VAT is calculated at 17.5% but this may alter to reflect any change in the applicable VAT rate.



Sports exhaust. Oval shaped dual exhaust pipes in matt black



Carbon design package for engine bay

Packages

Some items work well together, which is why we've created these special packages. They provide increased convenience and value by combining several of our most popular options.

Order Code		RS 5	Basic RRP	Total RRP inc VAT
WB1	Comfort package. Cruise control and mobile telephone preparation – Bluetooth interface	●	£246.80	£290.00
WB3	Sound package. Bang & Olufsen sound system and DAB digital radio	●	£425.53	£500.00
WB4	Technology package – Low. Satellite Navigation system – DVD-based with Audi Music Interface and cruise control	●	£1,272.34	£1,495.00
WB7	Technology package – High. Satellite Navigation system – HDD-based with MMI 3G, Audi Music Interface and cruise control	●	£1,663.83	£1,955.00

Satellite Navigation system – DVD-based. DVD-based route-planning and guidance with MMI control logic and 6.5" colour monitor, 3D map display, RDS radio, DVD-player for navigation system, audio or MP3 CDs. Includes European coverage disc

Satellite Navigation system – HDD-based, with MMI 3G. 3rd generation of MMI including 2 FM tuners, high resolution (800x400) 7" colour TFT display, DVD movie-playing function, colour Driver's Information System, 2 SD card readers and 40GB hard drive – 10GB of which can be used to store up to 4,000 songs. HDD navigation functionality includes advanced speech recognition, 3D and topographical mapping display and advanced 3D building display

Options are subject to availability and may extend delivery.

- = Not available
- = Available
- S = Standard

RRP – Recommended Retail Price.

VAT is calculated at 17.5% but this may alter to reflect any change in the applicable VAT rate.



MMI 3G – High, part of Satellite Navigation system – HDD-based



Bang & Olufsen sound system



Audio and communication

Stay in touch using our range of communication functions, and give each journey its own soundtrack with our advanced audio equipment.

Order Code		RS 5	Basic RRP	Total RRP inc VAT
8UM	Audi Symphony radio , with front-loading MP3-compatible 6-CD changer, 6.5" colour screen, SD memory-card reader and AUX-IN socket in centre console	●	£234.04	£275.00
QV3	DAB digital radio	●	£255.32	£300.00
9VK	Bang & Olufsen sound system , designed specifically for the RS 5, providing surround sound reproduction with dynamic noise compensation, 14 high performance loudspeakers (505-Watt) and 10-channel amplifier	●	£446.81	£525.00
9ZX	Mobile telephone preparation – Bluetooth interface	●	£217.02	£255.00
9ZF	Mobile telephone preparation – Low. Uses Bluetooth interface or cradle to connect to your RS 5, including roof aerial for optimal reception and charger. A phone adaptor is required at extra cost – please consult your Audi Centre for phone compatibility	●	£319.15	£375.00
9ZW	Mobile telephone preparation – High. Uses Bluetooth interface with no physical connection to your RS 5, including roof aerial for optimal reception. Please note that your mobile phone must have SIM-Access Profile facility for full functionality. (Only in combination with a technology package)	●	£553.19	£650.00
PT4	Mobile telephone preparation – High (with privacy handset). The handset allows passengers to make private calls, providing remote control of the telephone functions as well as a convenient SMS text messaging function. The handset is charged from a docking station integrated into the front centre armrest. (Only in combination with a technology package)	●	£808.51	£950.00
UF7	Audi Music Interface (AMI). Universal connection for use with stereo audio sources, USB and MP3 devices including Apple iPod generation 4 onwards (iPod, iPod classic, iPod mini, iPod nano, iPod photo, iPod video, iPod touch). Provides intuitive control through the audio system and multi-function steering wheel. It also replicates the iPod display on the audio screen and DIS, including track titles. The interface provides charging function (dependent on device). Includes 2 cables to connect your iPod or USB MP3 device	●	£212.77	£250.00
7A6	CD changer (only in combination with technology package – Low)	●	£255.32	£300.00
7D1	CD changer (only in combination with technology package – High)	●	£255.32	£300.00
QV9	TV reception – analogue and digital (only in combination with a technology package)	●	£723.40	£850.00

Options are subject to availability and may extend delivery.

- = Not available
- = Available
- S = Standard

RRP – Recommended Retail Price.

VAT is calculated at 17.5% but this may alter to reflect any change in the applicable VAT rate.

Interior equipment

Specify every detail of your car's interior with this range of exclusive options.

Options are subject to availability and may extend delivery.

- = Not available
- = Available
- S = Standard

*HomeLink® is a registered trademark of Johnson Controls. For information on compatibility, visit www.homelink.com

RRP – Recommended Retail Price.

VAT is calculated at 17.5% but this may alter to reflect any change in the applicable VAT rate.

Order Code		RS 5	Basic RRP	Total RRP inc VAT
4F2	Advanced key. Access and authorisation system which automatically exchanges data between key and vehicle, allowing the driver to keep the key in their pocket or bag at all times. To unlock and open, simply lift the exterior door handle. To lock, press the button on the handle. Pressing the start/stop button integrated in the centre console starts and stops the engine	•	£421.28	£495.00
4L6	Auto-dimming rear-view mirror. Includes acoustic windscreen	•	£187.23	£220.00
8T1	Cruise control	•	£187.23	£220.00
8T4	Adaptive cruise control (ACC). Automatic distance regulation, using radar sensors to maintain required distance by braking and accelerating. 4 programs (distance 1 to distance 4) set via steering column controls of the cruise control system	•	£936.17	£1,100.00
3Y2	Electric rear window blind	•	£191.49	£225.00
VC1	Garage door opener (HomeLink*). Programmable radio operated remote control for compatible doors/gates. Control buttons integrated in the roof module at the front	•	£148.94	£175.00
PKH QE1	Storage package. Comprising storage nets on front-seat backrests, storage compartment under the front seats (if memory function is fitted, only under the front-passenger seat), drinks holder in the rear centre armrest and a lockable glove compartment. Also includes tie-down straps and 12V socket in the boot. (Not in combination with RS embossed bucket seats)	•	£148.94	£175.00
YTZ S3G	Audi exclusive Black floor mats with RS 5 logo	•	£365.96	£430.00



Seats

Choose from a variety of different seat options so you can maintain the right driving posture at all times.

Order Code		RS 5	Basic RRP	Total RRP inc VAT
4A3	Heated front seats	●	£234.04	£275.00
4A4	Heated front and outer rear seats	●	£382.98	£450.00
P55 4A3 N1T	RS embossed bucket seats in Fine Nappa leather. With more pronounced seat contours to give increased lateral support for sporty driving. Heated, with electric lumbar support and width adjustment for seat cushion and backrest. Manual forwards/backwards, seat height and backrest adjustment. This option deletes front side airbags and ISOFIX preparation for front passenger seat. Not available in combination with storage package, electric front seats or through-load facility	●	£1,174.47	£1,380.00
PV3 6XL 4L6	Convenience package. Comprising electric front seats with memory function on driver's side and lumbar support. Also includes electrically folding and auto-dimming door mirrors with memory function, auto-dimming rear view mirror and acoustic windscreen (not in combination with RS bucket seats)	●	£510.64	£600.00
7HB	Leather armrests – includes leather-covered armrest on front door panel and rear side panel	●	£212.77	£250.00

Options are subject to availability and may extend delivery.

- = Not available
- = Available
- S = Standard

RRP – Recommended Retail Price.

VAT is calculated at 17.5% but this may alter to reflect any change in the applicable VAT rate.

Exterior equipment

Make sure your car looks exactly as you want it to by selecting some of our striking options.

Order Code		RS 5	Basic RRP	Total RRP inc VAT
8N7	High-beam assist. Automatically adjusts headlights from high-beam to dipped-beam when another vehicle is approaching. Only in combination with auto-dimming rear-view mirror	●	£93.62	£110.00
4ZM	Black styling package. Grille surround in highly polished black, number plate surround and window capping strips in matt black	●	£302.13	£355.00
6XE	Door mirrors – electrically folding	●	£148.94	£175.00
6XK 4L6	Door mirrors – electrically folding and auto-dimming. Includes auto-dimming rear-view mirror and acoustic windscreen	●	£404.26	£475.00
3FC	Electric tilt panoramic sunroof	●	£723.40	£850.00
VJ4	Matt aluminium styling package – front lip spoiler and bottom edge of rear diffuser in matt aluminium	●	£565.96	£665.00
VW1	Privacy glass. Dark tinted glass from the B pillar backwards	●	£276.60	£325.00

Options are subject to availability and may extend delivery.

- = Not available
- = Available
- S = Standard

RRP – Recommended Retail Price.

VAT is calculated at 17.5% but this may alter to reflect any change in the applicable VAT rate.



Electric tilt panoramic sunroof



Matt aluminium styling package – rear diffuser in matt aluminium



Matt aluminium styling package – front lip spoiler

Safety and security

Intelligent technology designed to give you better all-round awareness and safety on the road.

Order Code		RS 5	Basic RRP	Total RRP inc VAT
7X8	Audi parking system advanced. Aids parking by acoustically and visually indicating distances to obstacles with guiding lines. Measured by sensors and reversing camera (only in combination with technology package)	●	£340.43	£400.00
UH2	Audi hill-hold assist. Automatically activates electromechanical parking brake when stationary	●	£55.32	£65.00
7Y1	Audi side assist. Aids the driver when changing lane. Audi side assist monitors the area behind your car, using radar sensors located discreetly in the rear bumper, informing the driver with a visual warning signal in the door mirror if there is a vehicle in their blind spot or approaching quickly from behind. The system is activated using a button in the driver's door	●	£382.98	£450.00

Options are subject to availability and may extend delivery.

- = Not available
- = Available
- S = Standard

RRP – Recommended Retail Price.

VAT is calculated at 17.5% but this may alter to reflect any change in the applicable VAT rate.



Steering wheels and controls packs

Audi exclusive

With Audi exclusive, you can choose a luxurious leather steering wheel or controls pack in a choice of colours from the Audi exclusive range.

Options are subject to availability and may extend delivery.

- = Not available
- = Available
- S = Standard

*The leather, stitching and leather piping (where applicable) can be selected from any of the exclusive colours shown on page 22. The carpet colour can also be selected from any of the exclusive colours shown on page 22, except for Crimson red and Saddle brown.

RRP – Recommended Retail Price.

VAT is calculated at 17.5% but this may alter to reflect any change in the applicable VAT rate.

Order Code		RS 5	Basic RRP	Total RRP inc VAT
YRH S3G	Audi exclusive leather-covered steering wheel*	•	£302.13	£355.00
YRB S3G	Audi exclusive controls package. Includes leather-covered steering wheel and gear-shift gaiter*	•	£510.64	£600.00
YUC 3SG	Audi exclusive control package in black suede – includes steering wheel rim and gearshift knob in black suede. Stitching colour can be specified in a variety of colours from the Audi exclusive range	•	£629.78	£740.00
YSR S3G	Audi exclusive floor mats with leather piping. Includes 4 floor mats for front and rear (cannot be combined with option YSQ/S3G – Audi exclusive carpets)*	•	£365.96	£430.00
YSQ S3G	Audi exclusive carpets. Includes 4 Audi exclusive floor mats with leather piping (cannot be combined with option YSR/S3G – Audi exclusive floor mats)*	•	£723.40	£850.00



Warranty

Order Code		RS 5	Basic RRP	Total RRP inc VAT
-	Audi Warranty , covering you for unlimited mileage in the first two years of ownership, and up to 60,000 miles in the third year. Transferable between owners*	S	No charge	No charge
EA6	Audi Warranty , covering you for up to 4 years or 75,000 miles, whichever comes soonest. Cover includes a two-year unlimited-mileage warranty, and up to 75,000 miles in the third and fourth years. Transferable between owners*	●	£446.81	£525.00
EA9	Audi Warranty , covering you for up to 5 years or 90,000 miles, whichever comes soonest. Cover includes a two-year unlimited-mileage warranty, and up to 90,000 miles in the third, fourth and fifth years. Transferable between owners*	●	£1,046.81	£1,230.00

Options are subject to availability and may extend delivery.

- = Not available
- = Available
- S = Standard

*Only available when ordering your new RS 5. Please speak to your Audi Centre for full details.

RRP – Recommended Retail Price.

VAT is calculated at 17.5% but this may alter to reflect any change in the applicable VAT rate.

Merchandise

From the enthusiasts' motorsport collection to the sophisticated Audi collection, there's a wide variety of adults' and children's clothing, lifestyle accessories and collectables, all of which bear the Audi name.

Please speak to a member of our team at your local Audi Centre to see the full Audi collection and to place an order. A selection of Audi merchandise is also available to buy from audi.co.uk/merchandise.



Audi kids



Bags and leather goods



Clothing



Motorsports



Sport and travel



Model cars

RS 5 technical data

Engine	4.2 FSI quattro
Transmission	7-speed S tronic
Cylinder	8
Displacement, cubic cm (valves per cylinder)	4163
Max. power ¹ , PS at rpm	450/8250
Max. torque, Nm at rpm	430/4000-6000
0-62mph acceleration, seconds	4.6
Top speed, mph*	155
CO ₂ emissions ² , g/km	252
Benefit in kind (BIK)%	35%
Fuel consumption, mpg (l/100km) Urban	19.0 (14.9)
Fuel consumption, mpg (l/100km) Extra Urban	33.2 (8.5)
Fuel consumption, mpg (l/100km) Combined	26.2 (10.8)
ABI insurance group 1-50**	44E
Unladen weight ³ , kg	1725
Gross weight limit, kg	2225
Roof load limit/nose weight ⁴ , kg	N/A
Max trailer load unbraked ⁴ , kg	N/A
Max trailer load with 12% gradient ⁴ , kg	N/A
Max trailer load with 8% gradient ⁴ , kg	N/A
Luggage compartment capacity, litres ⁵	455/829
Fuel tank capacity approx, litres	64

*Electronically limited. Please see page 29 for option to increase limit.

**Highest insurance group rating shown. Group may be lower dependent on trim level. Please visit www.thatcham.org/wabigrouprating for details.

¹The given value was obtained in accordance with the specified measurement procedure (the respective current version of Directive 80/1269/EEC).

²The given values were calculated in accordance with the specified measurement procedure (the respective current version of Directive 80/1268/EEC). This information does not relate to a single vehicle and does not comprise part of the offer but is merely intended for the purpose of comparison between the different vehicle types.

³Vehicle's unladen weight without driver (calculated in accordance with the current version of Directive 92/21/EEC). The fitting of additional equipment may increase the vehicle's unladen weight and drag coefficient, whereupon the potential carrying capacity and top speed will be correspondingly reduced.

⁴Vehicle not suitable for towing equipment.

⁵Second value; loaded up to roof with rear seat folded down.



RS 5 dimensions

The technical drawings opposite show the exact dimensions of the RS 5 Saloon, so you can check everything – from whether the car will fit in your garage to whether your luggage will fit in the boot.

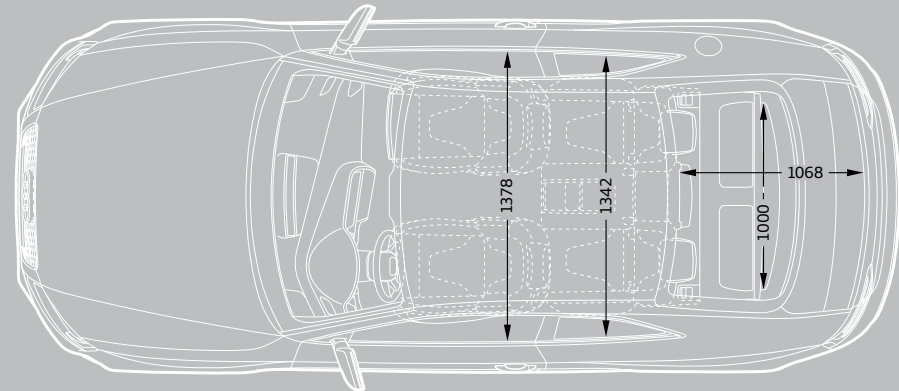
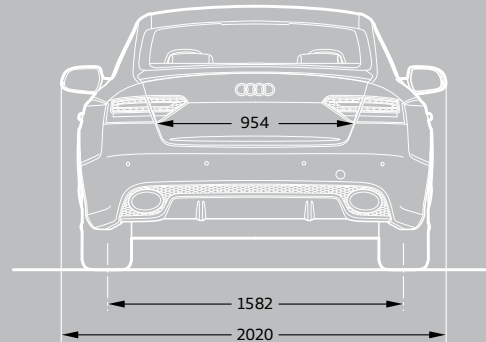
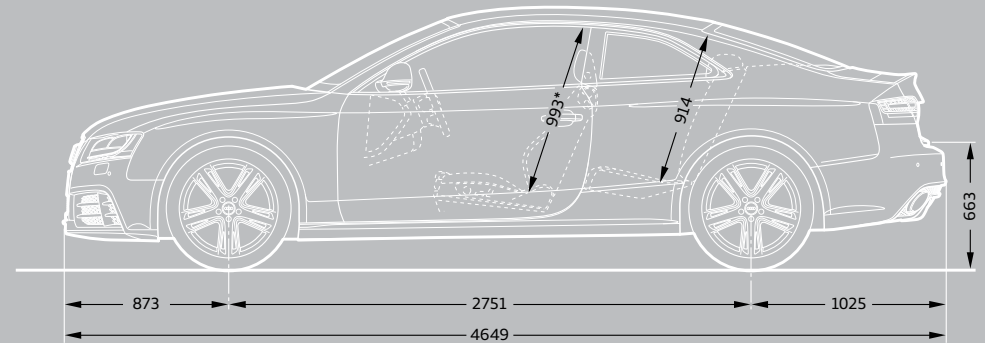
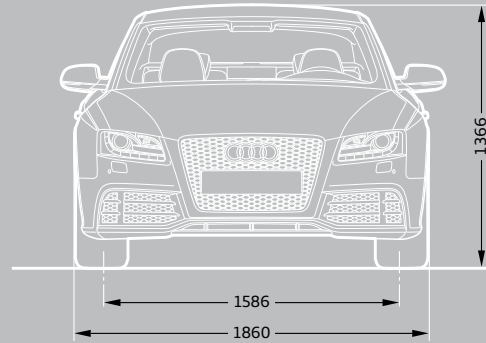

Dimensions in millimetres

*Maximum headroom

Dimensions were measured with vehicle at unladen weight, ground clearance measured with vehicle carrying its maximum load.

Luggage compartment volume in litres: 455/829 (measured by the VDA standard test method using 200 x 100 x 50mm blocks; second value: with rear seat folded down). Turning circle approx. 11.6m.

Additional information

CO₂ data and information

CO₂ emissions-based Vehicle Excise Duty

Vehicle Excise Duty (Road Fund Licence) is based upon the amount of Carbon Dioxide (CO₂) a vehicle emits, measured in grams per kilometre (g/km). The DVLA has created thirteen categories:

Petrol and Diesel engines

A - up to 100g/km	£0.00
B - 101 to 110g/km	£0.00
C - 111 to 120g/km	£0.00
D - 121 to 130g/km	£0.00
E - 131 to 140g/km	£110.00
F - 141 to 150g/km	£125.00
G - 151 to 165g/km	£155.00
H - 166 to 175g/km	£250.00
I - 176 to 185g/km	£300.00
J - 186 to 200g/km	£425.00
K - 201 to 225g/km	£550.00
L - 226 to 255g/km	£750.00
M - over 255g/km	£950.00

Vehicle Excise Duty (VED) rates correct at time of going to print, but these may alter to reflect any change in the applicable VED rate

Servicing tailored to your needs

Regular servicing is key to safeguarding your Audi's performance and a full Audi service history could help you preserve the future re-sale value. To make servicing easy, the Audi Service Schedules have been designed to work with your individual driving style and vehicle.

There are two schedules available and your Audi Centre will advise which schedule is most suited to your needs. The conventional fixed Audi Inspection Service schedule has fixed intervals for the Oil-change and Inspection Service that are based on time

and distance, whichever comes first. With the Audi LongLife Service schedule, sensors take account of driving style and conditions in which the vehicle is used to indicate when the Oil-change Service is required. Oil-change Service intervals are therefore variable and are conveniently indicated via the on-board service interval display.

Fixed Inspection Service Schedule

	Vehicle usage:
Mileage	Less than 10,000 miles per annum
Type of journey	Mainly city/town centre driving. Short journeys.
Conditions	Frequent cold starts. High engine loading – e.g. frequent hill climbs, vehicle fully loaded, towing
Driving style	Uneconomical – e.g. heavy acceleration, heavy braking, constant changes in speed, constant use of high revs, 'sporty' driving
	Service Intervals:
Oil-change Service	Fixed to every 9,000* miles/1 year
Inspection Service	Fixed to every 19,000* miles/2 years

Variable LongLife Service Schedule

	Vehicle usage:
Mileage	More than 10,000 miles per annum
Type of journey	Motorway and main road driving. Mainly longer distance journeys. Constant speeds
Conditions	Normal engine loading – e.g. with little or no towing, with little or no hill climbs. Normal vehicle loading
Driving style	Moderate acceleration, moderate braking, engine revs mainly below 3,000
	Service Intervals:
Oil-change Service	Variable to a maximum of every 19,000* miles/2 years
Inspection Service	Fixed to every 19,000* miles/2 years

*As indicated by the service interval display. Mileages are approximate as the Service Indicator system uses kilometres as its distance measurement.

Additional information

Welcome to Audi

By placing an order for your Audi, you're choosing to get behind the wheel of one of the most sophisticated cars on the road. And because we believe the service we offer should be just as advanced, we wanted to let you know exactly what you can expect from us, now and in the future.

We've agreed a set of standards with all our Centres, which governs the way we do business with you. It outlines the kind of service we promise to deliver for every customer, right down to filling each new Audi we sell with half a tank of fuel.

So whether you're interested in the date your car will arrive in the UK or the way we'll dispose of non-biodegradable materials after we service your Audi, you can have total confidence in us.

Audi Promise

Audi Centres

We guarantee that all of our Centres will be open as follows:

Sales: Monday to Friday 9am–6pm
Saturday 9am–5pm

Service: Monday to Friday 8am–6pm
Saturday 8.30am–1pm

Sunday opening is at local discretion.

New car delivery

Once we've confirmed a delivery date for your car, we'll keep you informed of progress. Subject to reasonable notice, we'll then deliver it to a place of your choice, whether that's your home or place of work. In the unlikely event of a delay, we'll provide a courtesy car to minimise inconvenience and keep you mobile.

The experts in Vorsprung durch Technik

Would you entrust your Audi to anyone who hasn't been regularly trained to Audi standards? Our network of Audi Approved Master Technicians have undergone an impressive 100,000 hours of training over a 10-year programme to ensure they have the latest technical expertise for maintaining and servicing your Audi. All of our Service Advisors undergo a specialist induction and training to ensure they are Audi professionals and able to talk to you about any issues you may have with your Audi vehicle. What's more, we have so much expertise and experience in looking after Audi vehicles that we are able to make a note of your mileage and the state of your vehicle as and when we see it and predict when certain key events may occur. As part of our commitment to you, we will notify you in plenty of time so you can make an appointment with us.

Your convenience comes first

At Audi you can choose from a range of convenient services that suit your needs. Why not book a 'service while you wait' appointment* and enjoy our complimentary refreshments while your car is with us? Or, if you need to be mobile, take advantage of one of our courtesy cars which we can even collect and deliver to you.* We guarantee we can service your Audi within 5 days without a courtesy car, or within 10 days if you need transport. We will also ensure your car is returned to you with a full valet.

Audi Genuine Parts

Would you put a part into your Audi that wasn't the same quality as the factory fitted original? You can rest assured that only Audi Genuine Parts will be used on your vehicle. What's more, Audi parts and labour come with a 2-year guarantee.** We stock a wide variety of parts, so we are well covered. However, if we don't have a part in stock at our Centre we have the back-up of parts at other Audi Centres, at our national warehouse and our factory and can usually source the relevant part very quickly.

We don't like surprises either

We believe strongly in transparency and there will be no hidden costs. For added peace of mind, we will give you a quotation over the phone for the work you have requested and email you the price confirmation. We'll consult you if any additional work on your car is needed when it is with us. We won't carry out any extra work without asking your permission first.

The Audi Stamp

Regular servicing is key to safeguarding your Audi's performance and a full Audi service history could help you preserve the future re-sale value of your car. Only the Audi Stamp will prove your approved Audi service history.

Getting better every time

We continually gather feedback from our Audi Trained Technicians, as well as our customers, to ensure our vehicles are running as they should. Whenever we see an Audi for a service, we connect it directly to our headquarters in Ingolstadt which enables us to check your car's software and make sure it's as up-to-date as possible. If the factory has released a software upgrade for your model, it can be applied immediately – improving anything from your car's efficiency to the precision of its parking system.

Environmental commitment

We promise to dispose of all non-biodegradable materials from your vehicle in a responsible manner.

*Subject to availability.

**Excludes wear and tear.

Pricing information

Pricing

Prices and specifications given are correct at the time of printing. Always check details with your Audi Centre, as Audi policies are continually developing. We reserve the right to change prices or specifications at any time.

All prices are subject to VAT, currently charged at 17.5% but this may alter to reflect any change in the applicable VAT rate.

Delivery charges and number plates are not included in the vehicle price.

Delivery charge	£473.62
Number plate	£20.00
VAT	£86.38
Total	£580.00

Audi Roadside Assistance

Your new car comes complete with 3 years' complimentary roadside assistance and recovery across the UK provided by RAC Motoring Services. Also included is roadside assistance throughout Europe, managed by RAC Motoring Services.

Audi Customer Care

Every new Audi benefits from the comprehensive Audi Customer Care Package, which comprises:

- ▶ A 3-year Audi warranty, which covers you for unlimited mileage in the first 2 years of ownership, with a full mechanical and electrical warranty which covers you for up to 60,000 miles in the 3rd year
- ▶ A 3-year paint warranty
- ▶ A 12-year anti-corrosion warranty
- ▶ 3 years' UK roadside assistance and recovery

You also have the option when ordering your new car of choosing a 4-year or 5-year Audi warranty. Speak to a member of the sales team for more information.

Audi Tax-Free Sales

If you are entitled to purchase a vehicle free of VAT, normally through Military or Diplomatic privilege, please contact your local Audi Centre for full details.

Should you have any difficulty obtaining the information you require, please call Freephone 0800 585878.

Audi Finance

Audi Finance specialise in providing funding solutions for Audi drivers. Whether your Audi is for private or business use, there are a range of funding options to choose from.

Below is the full range of finance products:

- ▶ Solutions – a Personal Contract Plan
- ▶ Hire purchase
- ▶ Lease purchase
- ▶ Finance lease
- ▶ Contract hire

With all products, you can choose a fixed-cost maintenance plan designed to help you budget accurately.

No matter what Audi model you choose, your local Audi Centre can provide you with a personalised quote which could fit your budget and motoring needs.

Audi Finance is a trading name of Volkswagen Financial Services (UK) Limited. An offer of finance depends on certain conditions. Available to people over 18 in the UK only.

Audi Insurance

We want you to start enjoying your new car from day one and thanks to Audi Insurance complimentary seven day cover, you can. Call free on 0800 316 7893 (lines are open Monday to Friday 8am - 9pm, and Saturday 9am - 5pm), provide a few details and a cover note will be sent to your Audi Centre. They will then tax your car and you can drive it away.

Audi Insurance is a trading name of Volkswagen Insurance Service (Great Britain) Limited, an appointed representative of Volkswagen Financial Services (UK) Limited, Brunswick Court, Yeomans Drive, Blakelands, Milton Keynes MK14 5LR. Registered in England number 2835230. Audi Insurance is sold, underwritten and administered by Allianz Insurance plc registered in England number 84638. Registered office 57 Ladymead, Guildford, Surrey GU1 1DB. Volkswagen Financial Services (UK) Limited and Allianz Insurance plc are authorised and regulated by the Financial Services Authority. Volkswagen Financial Services (UK) Limited and Allianz Insurance plc are not part of the same corporate group.

Audi UK

Customer Services
Selectapost 29
Sheffield
S97 3FG
0800 699888
audi.co.uk

Specifications and prices subject
to change without notice.

© Audi UK

Printed in the UK
Edition 1.0 07/10
2011 model year

Images are for illustrative purposes only.