



The new Audi A6 Saloon

Pricing and Specification Guide

Valid from January 2011

Personalising your Audi A6 Saloon

This guide has been designed to help you tailor and price your Audi A6 Saloon quickly and logically. At the back, you will find information on CO₂ emissions-based taxation and the other services offered by Audi, including Finance and Insurance. Alternatively, you can go to audi.co.uk and configure your Audi A6 Saloon online.

The Audi A6 Saloon

Efficiency	8
Engines	10
Transmissions	11
quattro®	12

Model details and prices

SE model equipment	14
S line model equipment	16
Model prices	18

Colour and upholstery

Paint	20
Upholstery and seats	22
Colour and trim guide	28
Inlays	30

Options

Wheels, tyres and suspension	32
Packages	34
Audio and communication	36
Interior equipment	40
Exterior equipment	42
Safety and security	44
Steering wheels	47
Service Plan and Warranty	48
Merchandise	49
Accessories	50

Technical details

Technical data	51
Dimensions	52
Additional information	53
Pricing information	55





Vorsprung durch Technik

Three words that express the very essence of Audi. Vorsprung durch Technik isn't a slogan. It's our way of seeing the world. It is the driving force behind our history of innovation that continues into the 21st century. Indeed, many technologies that Audi pioneered remain in our cars today. Some are milestones in the history of the motorcar.

From our beginnings in 1899, to the Auto Union team's Grand Prix successes in the 1930s and our more recent wins at Le Mans, we have always been at the forefront of the motor industry.

Vorsprung durch Technik makes us who we are. To see more of its influence, just read on.

The Audi A6 Saloon

The latest generation of the Audi A6 is one of the most advanced and desirable cars in our range. Thanks to an intelligent combination of steel and aluminium, its body is now significantly lighter – which, combined with a new choice of engines, leads to 19% lower fuel consumption.

You'll find a wide range of equipment as standard, including SD card based navigation, 17-inch alloy wheels, Multi-Media Interface with a retractable 6.5" display and leather upholstery. You can also choose from a wide range of innovative options, including a 15-speaker Bang & Olufsen Advanced Sound System and a cockpit-style head-up display that enables you to keep your eyes on the road at all times.

Of course, that's just the beginning. Read on to see everything the Audi A6 has to offer.





Efficiency

At Audi, doing less is something we're trying to do more of. We're working to use less fuel, release less CO₂ and waste less energy. It's why we've incorporated a number of more efficient technologies into the Audi A6 Saloon.

Recuperation

When a vehicle brakes, the discs convert the kinetic energy into thermal energy, which is wasted as it cannot be used. With a recuperation system, like the one in the Audi A6 Saloon, the kinetic energy is converted into useful electrical energy. The way it works is simple. While the car is coasting or braking, the alternator voltage is raised above the level of the basic electrical system, which enables the alternator to generate electrical energy and store it temporarily in the battery. When the vehicle accelerates, this energy is used to relieve the load on the alternator, resulting in a fuel saving of up to 3%.

Enhanced air conditioning

The efficient cooling system in the Audi A6 can save up to 8 g/km of CO₂ compared with the previous model. It's thanks to a new brushless motor that's lighter, uses less energy and has a longer operating life.





Lightweight construction

From the earliest stages of its design, we looked for ways to save energy in the Audi A6 Saloon. It's why every component has been optimised for greater agility, improved efficiency and more driving pleasure. In fact, thanks to its hybrid aluminium construction, this advanced model is now 15% lighter than a conventional steel vehicle.

Efficiency programmes

The Driver's Information System in the Audi A6 Saloon comes as standard with an innovative efficiency programme, which offers advice on improving fuel economy as you drive. Also, via the standard Audi drive select system you can choose a new efficiency setting which aids you in driving even more economically. For more details, see page 14.

Automatic Start-Stop function

In heavy traffic, your car still uses fuel and releases CO₂, even when it's stationary. The automatic Start-Stop function counteracts this problem by switching off the engine when your car comes to a standstill. As soon as you touch the clutch, the car restarts. In conjunction with TDI® and TFSI®, it helps save up to 0.4 litres of fuel every 100km.

Engines

Petrol

TFSI® direct-injection technology is a unique Audi innovation that includes supercharging, which combines FSI® technology with forced induction – giving cars an extra injection of power and torque. It also delivers enhanced fuel efficiency as precisely the right amount of fuel and air are injected into the combustion chambers, enabling the engine to ‘breathe’ more easily. It results in reduced heat loss and increased output, with around a 15% reduction in fuel consumption and significantly lower exhaust emissions.

Diesel

We introduced TDI® to the roads in 1989, marking a departure from the noisy, fuel-thirsty diesel engines of the past. And since then, we’ve continuously refined it, recently developing common-rail technology. Under this system, a series of piezo injectors use electrical charge to precisely control the amount of fuel injected into the engine. As well as reducing noise, this allows combustion to happen at a lower temperature, with less oxygen, which lowers emissions.





Transmissions

multitronic®

Translating a driver's preferences and intentions into road performance, the multitronic® transmission system entertains no compromises – whether in terms of dynamism, convenience or economy. multitronic® automatic transmission is available on models without quattro® permanent all-wheel-drive. A continuously variable transmission, multitronic® can transmit up to 400 Nm of torque and permits an exceptionally wide range of gear ratios. The result is smooth, powerful acceleration and a high level of driving comfort. And thanks to its lightweight design and a number of advanced electronic control systems that monitor gradient, road conditions and the way the driver is using the accelerator pedal, multitronic® also plays an instrumental role in reducing fuel consumption.

S tronic®

Driving is all about thinking ahead, which is just what the S tronic® dual-clutch transmission does. It works almost as two separate systems, one engaging the odd-numbered and the other the even-numbered gears. So when you're accelerating in second, it has third gear waiting for you. And once you make the switch, it's already thinking about fourth. With two clutches working together, you can change gears almost instantly while experiencing smooth, uninterrupted power.

quattro®

It's the technology that has given Audi the edge on the racetrack ever since it was first introduced over 30 years ago – a technology that delivers ultimate control whilst enhancing the sporty characteristics which make the A6 Saloon so thrilling to drive. It's called quattro® permanent all-wheel-drive. The principle is simple: in the same way that four brakes ensure better deceleration, four permanently-driven wheels deliver better acceleration and road-holding, pushing or pulling the car as needed, for a driving experience that's both dynamic and safe.

In the A6 Saloon, asymmetric dynamic torque distribution continuously distributes drive power between the front and rear axles, depending on weather conditions, road surface and gradient. This leads to greater flexibility and an enhanced, sportier drive.

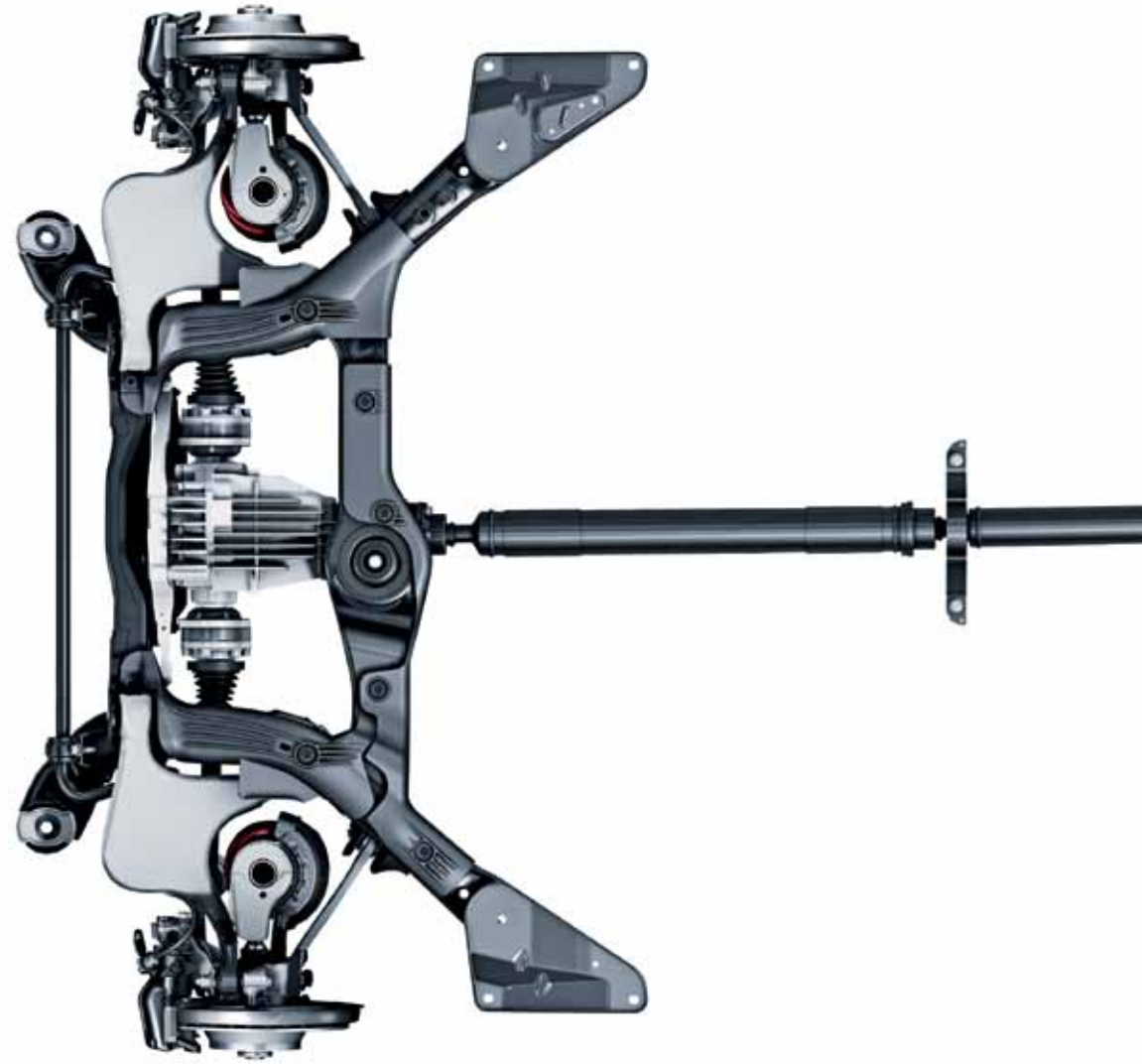
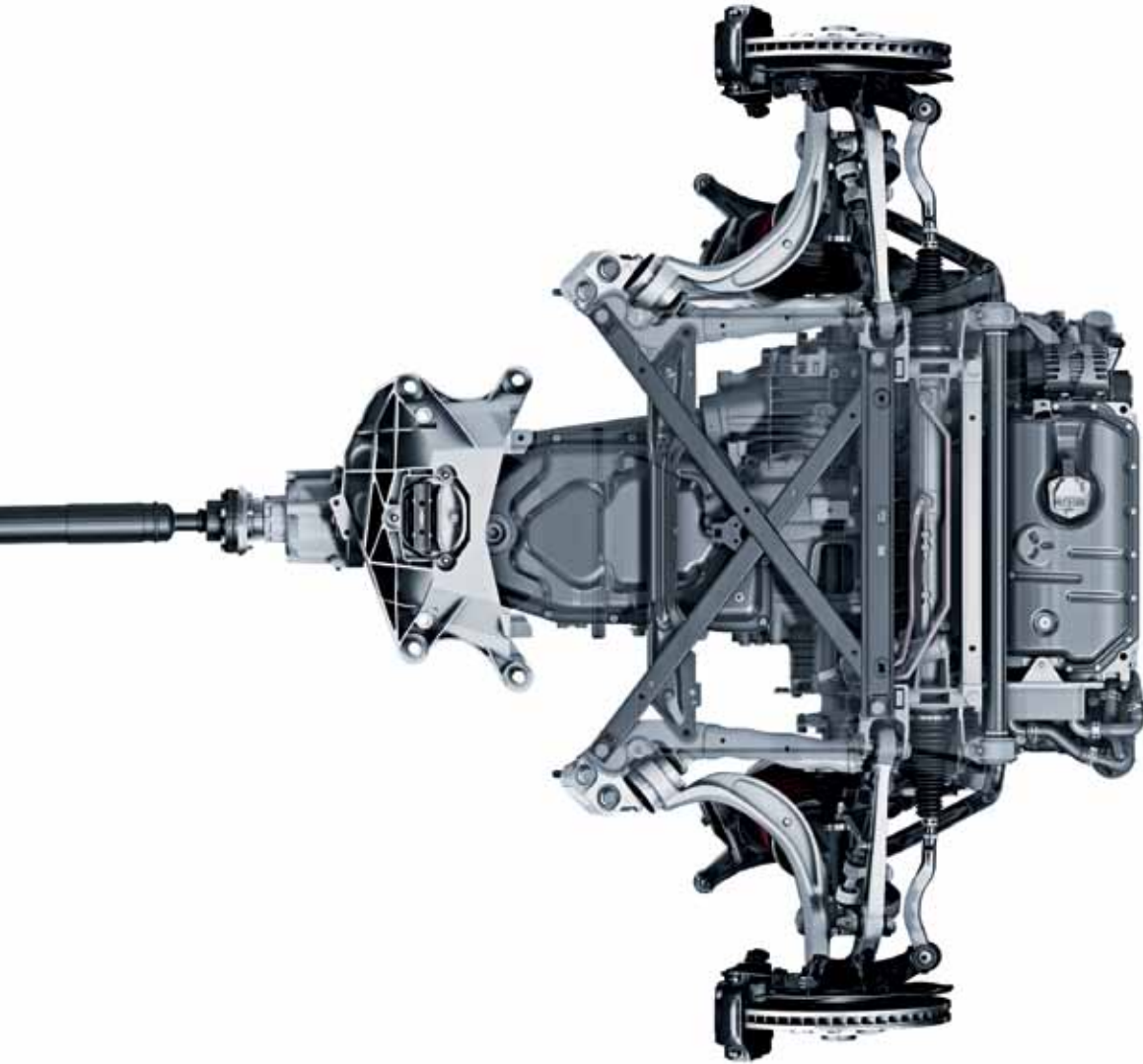

Image for illustrative purposes only.



quattro® with Sports differential

The optional electronically regulated Sports differential distributes variable amounts of drive force to each rear wheel, ensuring outstanding acceleration performance in corners and stabilising the vehicle's response to load change. It also brings better direct steering characteristics and, as it requires less steering effort, more agile handling.

SE model equipment

All A6 Saloon SE models have the following items of standard equipment

Engine and transmission

Start-Stop system with energy recuperation

Wheels, tyres and suspension

17" x 8J '10-spoke' design alloy wheels with 225/55 R17 tyres

Electromechanical parking brake

Dynamic suspension

Audi drive select with four pre-configured modes (Comfort, Auto, Dynamic and Efficiency), allowing the driver to electronically adjust the engine, transmission and steering. The new efficiency mode influences the shift program, electromechanical power steering, engine, cruise control, and where fitted: deluxe automatic air conditioner, adaptive air suspension, quattro® with Sports differential

Space-saver spare wheel

Anti-theft wheel bolts

Tool kit and car jack

Safety and security

Driver's Information System (DIS) – Monochrome display in the direct field of view of the driver. The DIS shows the radio frequency/station or the song title, outside temperature, trip computer, gear-shift display and telephone menu

Cruise control – maintains any speed above 18mph, provided the engine power output and engine braking effect permit it; operated via separate steering column stalk. The set speed is displayed in the Driver's Information System

Light and rain sensor – automatically switches the dipped beam or windscreen wipers on/off depending on the light and rain conditions; includes delayed deactivation/automatic activation of the rear lights and number plate lights when parking or opening the vehicle

Audi Parking System Plus – acoustic and visual park assist system for the front and rear with Multi-Media Interface (MMI) screen display; measurement is by ultrasonic sensors concealed in the bumpers

Tyre pressure monitoring display – provides a visual and acoustic warning of loss in pressure in one or more tyres; defective tyre is displayed in the Driver's Information System

Electronic Stability Programme (ESP)

First aid kit with warning triangle

Front airbags with front passenger deactivation – also includes side head airbags

Seat belt monitoring

Anti-theft alarm with tow-away protection via angle of inclination sensors (can be switched off), including interior monitoring system which can be switched off; alarm for monitoring doors, bonnet and tailgate, independent of vehicle electrical system



17" x 8J '10-spoke' design alloy wheels – PRQ



MMI Navigation with Bluetooth telephone (optional MMI Touch)



Milano leather seats in Velvet beige*

*Image shows optional comfort seats.

Seats

Split-folding rear seat back

Standard seats in Milano leather upholstery including seat covers, head restraints and front centre armrest. The leather is hard-wearing and durable. Includes manual adjustment for seat height, length, backrest angle, head restraint, belt height and steering wheel height and reach ISOFIX child seat mounting for front passenger (with airbag deactivation) and outer rear seats

Audio and communication

MMI Radio Plus including:

- MMI control panel operating the MMI display (6.5-inch retractable colour display)
- 2 SDHC memory card readers (up to 32GB) and single CD player that supports MP3, WMA and AAC
- TP memo – automatically saves traffic news when driving

MMI Navigation (SD card) includes:

- 6.5-inch retractable MMI colour display with high quality map display
- Voice control using whole words
- Dynamic route guidance
- Additional display in the Driver's Information System

Audi Sound System

- 6-channel amplifier
- 180-Watt amplifying capacity
- 10 loudspeakers including subwoofer

Mobile telephone preparation – Bluetooth Interface: Bluetooth-compatible mobile phones can be connected to the vehicle via the interface allowing handsfree calls via the microphone

Interior equipment

Dual-zone electronic climate control – automatic air conditioning which electronically regulates the air temperature, air flow rate and distribution for the driver and front passenger sides

4-spoke leather-trimmed multi-function steering wheel (with paddles for automatic transmissions)

Auto-dimming rear-view mirror – uses a photocell to recognise when the headlights behind are too bright and dims automatically

Front centre armrest for driver and front passenger, movable and with adjustable angle

Cloth headlining

Luggage compartment mat

Inlays in aluminium trigon

Door sill trims with aluminium inlays

Front and rear floor mats coordinated with the selected interior colour

Exterior equipment

Exterior mirrors; electrically adjustable and heated

Halogen headlights

Body-coloured door mirrors

Tow bar bracket preparation – tow bar preparation includes wiring to the control unit, fitting for control unit and adapted engine cooling. The set of parts for retrofitting is available from Audi Accessories or available as an option (see page 43)



S line model equipment

In addition to SE model equipment

Basic RRP
£1,958.33

Total RRP inc VAT
£2,350.00

Wheels, tyres and suspension

18" x 8J '5-twin-spoke' design alloy wheels with 245/45 R18 tyres
Sports suspension lowered by 10mm

Seats

Front Sports seats including electric 4-way lumbar support and manual adjustment for seat height, length, depth, backrest, head restraint, belt height and steering wheel reach and height

Seats upholstered in black Valcona leather with embossed S line logo in the front seat backrests

Interior equipment

S line 3-spoke leather multi-function Sports steering wheel with S line badge (includes paddles in automatic models)

Gear lever knob in black perforated leather

Door sill trims with S line logo

S line inlays in matt-brushed aluminium

Headlining in black cloth

Exterior equipment

S line badges on the front wings

S line front and rear bumpers, side ventilation grilles, side skirts

Chrome-plated trims for exhaust tailpipe

Platinum grey front spoiler lip and diffuser insert

Xenon headlights with LED daytime running lights

LED rear lights

Headlight washers



18" x 8J '5-twin-spoke' design alloy wheels – PQ1



S line rear styling with LED rear lights



S line interior styling with leather/Alcantara S line Sports seats



A6 Saloon SE

Engines	Power	Transmission	CO ₂ g/km	Basic RRP	Total RRP inc VAT	Recommended OTR
3.0 TFSI quattro	300PS	7-speed S tronic	190	£31,833.00	£38,200.00	£39,270.00
3.0 TDI	204PS	multitronic	137	£28,000.00	£33,600.00	£34,355.00
3.0 TDI quattro	245PS	7-speed S tronic	158	£31,917.00	£38,300.00	£39,100.00

A6 Saloon S line

Engines	Power	Transmission	CO ₂ g/km	Basic RRP	Total RRP inc VAT	Recommended OTR
3.0 TFSI quattro	300PS	7-speed S tronic	190	£33,792.00	£40,550.00	£41,620.00
3.0 TDI	204PS	multitronic	137	£29,958.00	£35,950.00	£36,705.00
3.0 TDI quattro	245PS	7-speed S tronic	158	£33,875.00	£40,650.00	£41,450.00

Please note: The maximum power output figures are quoted in PS (or Pferdestärke, which is the metric equivalent of brake horsepower). To convert to brake horsepower, divide the PS figure by 1.0139.

Recommended On-The-Road (OTR) retail prices include: delivery charge, half a tank of fuel, number plates at £590.00 (inc. VAT), Road Fund Licence (which may vary depending on model/transmission – see page 53 for details) and first registration fee at £55.00. Vehicle Excise Duty correct at time of going to print, but this may alter to reflect any change in the applicable VED rate.

RRP - Recommended Retail Price. The Audi A6 Saloon is available in April 2011. VAT is calculated at 20% but this may alter to reflect any change in the applicable VAT rate.





Paint

You can select one of the standard colours shown opposite or, for a different look, choose from a range of optional finishes.

Standard colours



Ibis white – T9

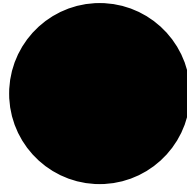

Brilliant black – A2

Optional colours

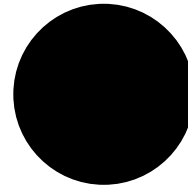

Havanna black, metallic – 4J

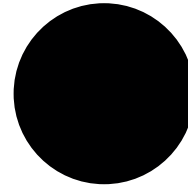

Oolong grey, metallic – 4N

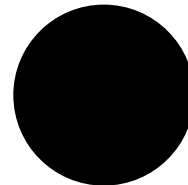

Phantom black, pearl effect – L8

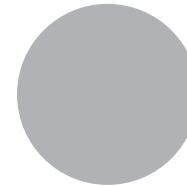

Ice silver, metallic – P5

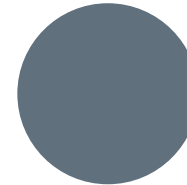

Moonlight blue, metallic – W1

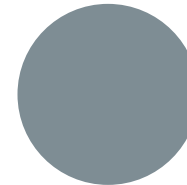

Quartz grey, metallic – Q4

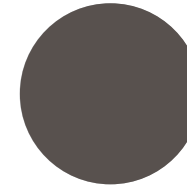

Dakota grey, metallic – Y7

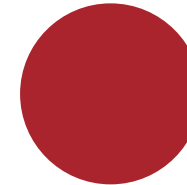

Garnet red, pearl effect – 9C

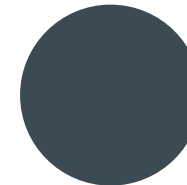

Aviator blue, metallic – U0

S line colours

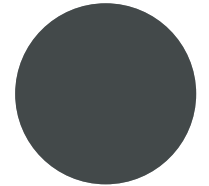

Daytona grey, pearl effect – 6Y

Options are subject to availability and may extend delivery.

All the colour swatches on this page are matched as accurately as possible to the actual paint colours used. However, due to print processes, Audi UK cannot guarantee that colours shown are 100% accurate.

Visit your local Audi Centre for a more accurate colour swatch.

RRP – Recommended Retail Price.

VAT is calculated at 20% but this may alter to reflect any change in the applicable VAT rate.

Optional and S line colours

Basic RRP
£625.00

Total RRP inc VAT
£750.00

Paint

Audi exclusive

Everyone has a favourite colour. No matter what yours is, Audi exclusive provides a range of unique colours that have been designed to set your car apart. Choose from the swatches here, or specify any other paint colour in the Audi range – whether it's Jet blue from the Audi R8 or Alpine white from the original Audi quattro. The choice is yours.

Customised

If you have a particular colour in mind, we'll mix the exact metallic or pearl-effect shade you want.*

*Custom paint is subject to factory approval, and is available for metallic and pearl-effect water-based paints only. Three-colour process colours and two-tone schemes are not available.

*Visit your local Audi Centre for colour samples.

All the colour swatches on this page are matched as accurately as possible to the actual paint colours used. However, due to print processes, Audi UK cannot guarantee that colours shown are 100% accurate.

Visit your local Audi Centre for a more accurate colour swatch.

RRP – Recommended Retail Price.

VAT is calculated at 20% but this may alter to reflect any change in the applicable VAT rate.

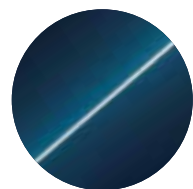

Palace blue, pearl effect

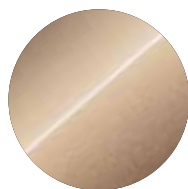

Sand beige, pearl effect

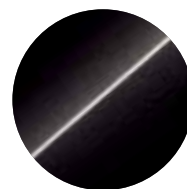

Saddle brown, pearl effect

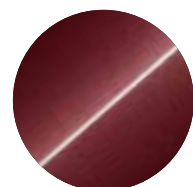

Classic red, pearl effect

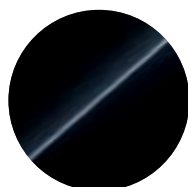

Mamba black, metallic

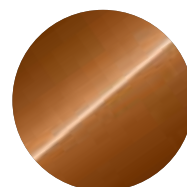

Ipanema brown, metallic



Any colour in the Audi range



100 Audi exclusive colours to choose from*



Customised paint

Audi exclusive

Basic RRP

£1,541.67

Total RRP inc VAT

£1,850.00

Customised*

Basic RRP

£2,458.33

Total RRP inc VAT

£2,950.00

Upholstery

Standard seats

Standard seats are manually adjustable for head restraint height or clearance, belt height, backrest angle, seat height and forwards and backwards seat position.

To further enhance your comfort you can choose to add electric lumbar support and seat heating.

Choose your favourite upholstery from the swatches shown opposite to give your car's interior the look and feel you want.

Options are subject to availability and may extend delivery.

- = Not available
- = Available
- S = Standard

RRP - Recommended Retail Price.

VAT is calculated at 20% but this may alter to reflect any change in the applicable VAT rate.

Milano leather – N5W

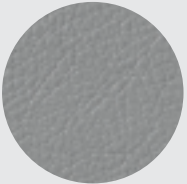
		SE	S line	Basic RRP	Total RRP inc VAT
 <p>Black – FZ</p>  <p>Titanium grey – VC/KN</p>	S	-	No charge	No charge	

Milano leather – seat covers, head restraints and front centre armrest in Milano leather, which is fully penetrated with dye and lacquered for excellent surface protection. The leather is extremely hard-wearing and durable, tanned without using chromium and gives a high-quality impression with its fine, grained surface

Valcona leather – N5D

		SE	S line	Basic RRP	Total RRP inc VAT
 <p>Black – FZ</p>  <p>Nougat brown – VB</p>  <p>Titanium grey – VC/KN</p>  <p>Velvet beige – VD/KP</p>  <p>Goa beige – VA</p>	•	-	£283.33	£340.00	

Valcona leather – seat covers, head restraints, door trims and front centre armrest in Valcona leather, a high-quality material which contributes to the elegance of the interior. A lacquered surface allows the material to breathe whilst the non-grained surface underlines the sophisticated character of the A6. Valcona leather is tanned without using chromium, dyed through and uses non-fading colour pigments

Upholstery

Standard seating options

Order Code		SE	S line	Basic RRP	Total RRP inc VAT
PV3	Electrically adjustable front seats with memory function for driver's side. Electrical adjustment for seat forwards and backwards position, seat height, angle and backrest angle adjustment, 4-way lumbar support, driver's seat with memory function. Only available in combination with exterior mirrors with memory function (6XL/6XF/6XM). Also available as part of the Comfort package (WB1) – please see page 34	●	–	£1,091.67	£1,310.00
7P1	4-way electric lumbar support, for driver's and front-passenger seats, with horizontal and vertical adjustment	●	–	£245.83	£295.00
4A3	Front heated seats for driver's and front-passenger seats; heat the seat cushions, backrest surfaces and seat-side bolsters and can be individually adjusted in 3 stages for each seat via a direct selection button on the air-conditioning controls. Must be combined with lumbar support (7P1)	●	–	£325.00	£390.00
4A4	Front and rear heated seats. Work in the same way as front seat heating, enabling you to regulate the rear seats separately. Only in combination with deluxe 4-zone climate control (9AQ) and lumbar support (7P1)	●	–	£625.00	£750.00
4D3	Seat ventilation for front seats. 3 different intensities of cool air blown through the seats using a fan for active ventilation of the seat-centre section and thigh support. To allow for the seat ventilation, the leather of the seat front is perforated. In combination with Standard seats, must be combined with electrically adjustable front seats (PV3), deluxe 4-zone climate control (9AQ) and Milano leather (NSW)	●	–	£700.00	£840.00

Options are subject to availability and may extend delivery.

– = Not available
● = Available
S = Standard

RRP – Recommended Retail Price.

VAT is calculated at 20% but this may alter to reflect any change in the applicable VAT rate.



Standard seat with optional 4-way lumbar support

Upholstery

Comfort seats – PS8

Comfort seats offer a multitude of electrical or pneumatic adjustment options with memory function for both front seats and exterior mirrors.

Electrically adjustable:

- Backrest angle, seat height, seat rake, forward and backward position and thigh support

Manually adjustable:

- Head restraint height/clearance and belt height

Pneumatically adjustable:

- Lumbar support, backrest side sections and seat-side sections.

Choose your favourite upholstery from the swatches shown opposite to give your car's interior the look and feel you want.

*When combining with seat ventilation options (4D3/4D8) the leather of the seat front will be perforated.

Options are subject to availability and may extend delivery.

- = Not available





• = Available

S = Standard

RRP – Recommended Retail Price.

VAT is calculated at 20% but this may alter to reflect any change in the applicable VAT rate.

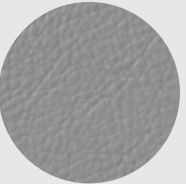
Milano leather – N5W

	SE	S line	Basic RRP	Total RRP inc VAT
 <p>Black – FZ</p>	•	-	£2,175.00	£2,610.00
 <p>Nougat brown – VB</p>	•	-	£1,083.33	£1,300.00
 <p>Titanium grey – VC/KN</p>	•	-		
 <p>Velvet beige – VD/KP</p>	•	-		
In combination with Comfort package (WB1)				

Milano leather – seat covers, head restraints and front centre armrest in Milano leather, which is fully penetrated with dye and lacquered for excellent surface protection. The leather is extremely hard-wearing and durable, tanned without using chromium and gives a high-quality impression with its fine, grained surface

Valcona leather* – N5D

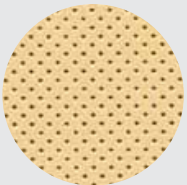
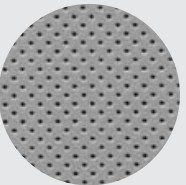
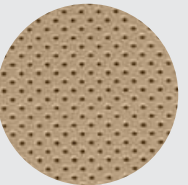
	SE	S line	Basic RRP	Total RRP inc VAT
 <p>Black – FZ</p>	•	-	£2,458.33	£2,950.00
 <p>Goa beige – VA</p>	•	-	£1,366.66	£1,640.00
 <p>Titanium grey – VC/KN</p>	•	-		
 <p>Velvet beige – VD/KP</p>	•	-		
In combination with Comfort package (WB1)				

Valcona leather – seat covers, head restraints, door trims and front centre armrest in Valcona leather, a high-quality material which contributes to the elegance of the interior. A lacquered surface allows the material to breathe whilst the non-grained surface underlines the sophisticated character of the A6. Valcona leather is tanned without using chromium, dyed through and uses non-fading colour pigments*

Upholstery

Comfort seats options

Order Code		SE	S line	Basic RRP	Total RRP inc VAT
4A3	Front heated seats for driver's and front-passenger seats; heat the seat cushions, backrest surfaces and seat-side bolsters and can be individually adjusted in 3 stages for each seat via a direct selection button on the air-conditioning controls	●	●	£325.00	£390.00
4A4	Front and rear heated seats. Work in the same way as front seat heating, enabling you to regulate the rear seats separately. Only in combination with deluxe 4-zone climate control (9AQ)	●	●	£625.00	£750.00
4D3	Seat ventilation for front seats. 3 different intensities of cool air drawn through the seat for active ventilation of the seat-centre section and thigh support. To allow for the seat ventilation, the leather of the seat front is perforated. Must be combined with deluxe 4-zone climate control (9AQ), Valcona leather (N5D) and front heated seats (4A3 or 4A4)	●	—	£700.00	£840.00
4DB	Massage and seat ventilation for front seats. Massage function with 5 different programmes (wave, pulse, stretch, lumbar, shoulders) and four levels of intensity for massaging the muscles with the help of 10 pneumatic cushions. Ventilation with 3 different intensities of cool air drawn through the seat for active ventilation of the seat-centre section and thigh support. To allow for the seat ventilation, the leather of the seat front is perforated. Only in combination with Comfort seats (PS8), deluxe 4-zone climate control (9AQ), Valcona leather (N5D) and front heated seats (4A3 or 4A4)	●	—	£1,333.33	£1,600.00



Comfort seat

Options are subject to availability and may extend delivery.

- = Not available
- = Available
- S = Standard

RRP – Recommended Retail Price.

VAT is calculated at 20% but this may alter to reflect any change in the applicable VAT rate.

Upholstery

Front Sports seats – PS1

Front Sports seats include 4-way lumbar support. Not available in conjunction with Comfort package.

*Leather/Alcantara only available in combination with electrically adjustable seats (PV3) and heated seats (4A3 or 4A4)





Options are subject to availability and may extend delivery.

-- = Not available
 • = Available
 S = Standard

All leather upholstery choices include seats, head restraints, door inserts and front centre armrest in leather. Leather/Alcantara choices include head restraints, seat-side bolsters and front centre armrest in leather with the seat centres and door inserts in Alcantara.

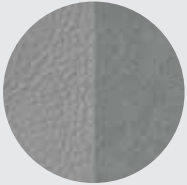
RRP – Recommended Retail Price.

VAT is calculated at 20% but this may alter to reflect any change in the applicable VAT rate.

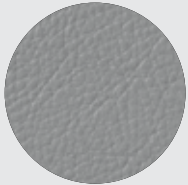
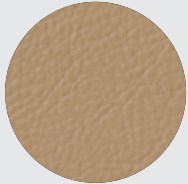
	SE	S line	Basic RRP	Total RRP inc VAT
Leather/Alcantara – N7U  Black - FZ  Titanium grey – VC/KN	•	–	£554.17	£665.00
Milano leather – N5W  Black - FZ	•	–	£554.17	£665.00
Valcona leather – N5D  Black - FZ  Goa beige – VA  Nougat brown – VB  Titanium grey – VC/VN  Velvet beige – VD/KP	•	–	£837.50	£1,005.00

Upholstery

S line Sports seats

Front S line Sports seats include electrically adjustable 4-way lumbar support.

Valcona leather – N1V
 Pearl Nappa leather/Alcantara – N7K

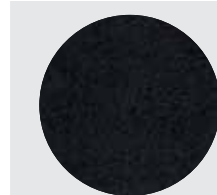

Black – QE



Black – QZ

Front Sport seats and S line Sports seats seating options

Options are subject to availability and may extend delivery.

- = Not available
- = Available
- S = Standard

All leather upholstery choices include seats, head restraints, door inserts and front centre armrest in leather. Leather/Alcantara choices include head restraints, seat-side bolsters and front centre armrest in leather with the seat centres and door inserts in Alcantara.

RRP – Recommended Retail Price.

VAT is calculated at 20% but this may alter to reflect any change in the applicable VAT rate.

Order Code	SE	S line	Basic RRP	Total RRP inc VAT
	I	S	No charge	No charge
	I	•	No charge	No charge
PV3	•	•	£1,091.67	£1,310.00
4A3	•	•	£325.00	£390.00
4A4	•	•	£625.00	£750.00

Colour and trim guide

Interior trim colours

Standard seats

To help you choose the right interior for your new A6 Saloon, please use this guide, showing the carpet, dashboard and headlining colours that have been matched to your chosen upholstery.

Order Code	Upholstery (seat centre/seat bolster)	Carpet	Dashboard (upper/lower)	Headlining	Milano leather (N5W)	Valcona leather (N5D)
FZ	Black/Black	Black	Black	Lunar silver	●	●
VA	Goa beige/Goa beige	Black	Black	Black	—	●
VB	Nougat brown/Nougat brown	Black	Black	Lunar silver	—	●
VC	Titanium grey/Titanium grey	Steel grey	Steel grey/Titanium grey	Lunar silver	●	●
VD	Velvet beige/Velvet beige	Moor brown	Moor brown/Velvet beige	Silk beige	—	●
KN*	Titanium grey/Titanium grey	Titanium grey	Steel grey/Titanium grey	Lunar silver	●	●
KP*	Velvet beige/Velvet beige	Velvet beige	Moor brown/Velvet beige	Silk beige	—	●

Comfort seats

Order Code	Upholstery (seat centre/seat bolster)	Carpet	Dashboard (upper/lower)	Headlining	Milano leather (N5W)	Valcona leather (N5D)
FZ	Black/Black	Black	Black	Lunar silver	●	●
VA	Goa beige/Goa beige	Black	Black	Black	—	●
VB	Nougat brown/Nougat brown	Black	Black	Lunar silver	●	—
VC	Titanium grey/Titanium grey	Steel grey	Steel grey/Titanium grey	Lunar silver	●	●
VD	Velvet beige/Velvet beige	Moor brown	Moor brown/Velvet beige	Silk beige	●	●
KN*	Titanium grey/Titanium grey	Titanium grey	Steel grey/Titanium grey	Lunar silver	●	●
KP*	Velvet beige/Velvet beige	Velvet beige	Moor brown/Velvet beige	Silk beige	●	●

*Including two-section dashboard and door trim panels, single/multi-tone.

Options are subject to availability and may extend delivery.

— = Not available
● = Available

VAT is calculated at 20% but this may alter to reflect any change in the applicable VAT rate.

Colour and trim guide

Interior trim colours

Sports seats

Order Code	Upholstery (seat centre/seat bolster)	Carpet	Dashboard (upper/lower)	Headlining	Leather/Alcantara (N7U)	Milano leather (N5W)	Valcona leather (N5D)
FZ	Black/Black	Black	Black	Lunar silver	●	●	●
VA	Goa beige/Goa beige	Black	Black	Black	—	—	●
VB	Nougat brown/Nougat brown	Black	Black	Lunar silver	—	—	●
VC	Titanium grey/Titanium grey	Steel grey	Steel grey/Titanium grey	Lunar silver	●	—	●
VD	Velvet beige/Velvet beige	Moor brown	Moor brown/Velvet beige	Silk beige	—	—	●
KN*	Titanium grey/Titanium grey	Titanium grey	Steel grey/Titanium grey	Lunar silver	●	—	●
KP*	Velvet beige/Velvet beige	Velvet beige	Moor brown/Velvet beige	Silk beige	—	—	●

S line Sports seats

Order Code	Upholstery (seat centre/seat bolster)	Carpet	Dashboard (upper/lower)	Headlining	Pearl Nappa leather/Alcantara (N7K)	Valcona leather (N1V)
QE	Black/Black	Black	Black	Black	—	●
QZ**	Black/Black	Black	Black	Black	●	—

*Including two-section dashboard and door trim panels, single/multi-tone

**Black/jet grey stitching on seats, steering wheel, gear lever gaiter and floor mats.

Options are subject to availability and may extend delivery.

— = Not available
● = Available

RRP – Recommended Retail Price.

VAT is calculated at 20% but this may alter to reflect any change in the applicable VAT rate.

Inlays

Inlays are the all-important finishing touch that add flair and interest to your car's interior.

Order Code		SE	S line	Basic RRP	Total RRP inc VAT
5MU	Aluminium trigon. Covers centre console, door trims and the continuous inlay seam	S	–	No charge	No charge
5TG	Matt-brushed aluminium. Covers centre console, door trims and the continuous inlay seam	–	S	No charge	No charge
5MP	Walnut, dark brown. Covers door trims and the continuous inlay seam, with aluminium-look edging. Not available in combination with interior colours VD or KP	●	–	£150.00	£180.00
5MG	Walnut, dark brown. Covers centre console, door trims and the continuous inlay seam, with aluminium-look edging. Not available in combination with interior colours VD or KP	●	–	£320.83	£385.00
5MV	Fine grain ash, natural brown. Covers door trims and the continuous inlay seam, with aluminium-look edging. Not available in combination with interior colours VD or KP	●	–	£150.00	£180.00
7TL	Fine grain ash, natural brown. Covers centre console, door trims and the continuous inlay seam, with aluminium-look edging. Not available in combination with interior colours VD or KP	●	–	£320.83	£385.00

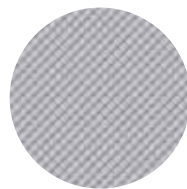

Aluminium trigon – **5MU**

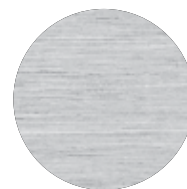

Matt-brushed aluminium – **5TG**



Walnut, dark brown – **5MP/5MG**



Fine grain ash, natural brown – **5MV/7TL**

Options are subject to availability and may extend delivery.

- = Not available
- = Available
- S = Standard

RRP – Recommended Retail Price.

VAT is calculated at 20% but this may alter to reflect any change in the applicable VAT rate.



Inlays, including the centre console, in Fine grain ash, natural brown

Wheels, tyres and suspension

Choose a set of specially-selected alloy wheels to subtly enhance the way your car looks and drives.



17" x 8J '10-spoke'
design alloy wheels - PRQ



18/19" x 8J '5-twin-spoke'
design alloy wheels - PQ1/PQ2



18" x 8J '5-spoke V'
design alloy wheels - PRM



18" x 8J '5-arm'
design alloy wheels - PRD



19" x 8.5J '15-spoke star'
design alloy wheels - PRY



19" x 8.5J '7-twin-spoke'
design alloy wheels - PQT



20" x 8.5J '10-spoke V'
design anthracite partly polished
alloy wheels - PRU



20" x 8.5J '5-segment-spoke'
design alloy wheels - PQS



20" x 8.5J '5-arm rotor'
design titanium look alloy wheels - PQU

Wheels, tyres and suspension

Order Code		SE	S line	Basic RRP	Total RRP inc VAT
PRQ	17" x 8J '10-spoke' design alloy wheels with 225/55 R17 tyres	S	—	No charge	No charge
PQ1	18" x 8J '5-twin-spoke' design alloy wheels with 245/45 R18 tyres	—	S	No charge	No charge
PRM	18" x 8J '5-spoke V' design alloy wheels with 245/45 R18 tyres	●	—	£525.00	£630.00
PRD	18" x 8J '5-arm' design alloy wheels with 245/45 R18 tyres	●	—	£650.00	£780.00
PRY	19" x 8.5J '15-spoke star' design alloy wheels with 255/40 R19 tyres	●	—	£1,308.33	£1,570.00
PQ2	19" x 8J '5-twin-spoke' design alloy wheels with 255/40 R19 tyres	●	—	£1,616.67	£1,940.00
		—	●	£654.17	£785.00
PQT	19" x 8.5J '7-twin-spoke' design alloy wheels with 255/40 R19 tyres	●	—	£1,616.67	£1,940.00
		—	●	£654.17	£785.00
PRU	20" x 8.5J '10-spoke V' design anthracite partly polished alloy wheels with 255/35 R20 tyres	●	—	£2,083.33	£2,500.00
PQS	20" x 8.5J '5-segment-spoke' design alloy wheels with 255/35 R20 tyres	●	—	£2,229.17	£2,675.00
		—	●	£1,266.67	£1,520.00
PQU	20" x 8.5J '5-arm rotor' design titanium look alloy wheels with 255/35 R20 tyres	●	—	£2,316.67	£2,780.00
		—	●	£1,354.17	£1,625.00
H46	Run-flat tyres. Journey can be continued on a flat tyre at a speed of up to 50mph and for a maximum distance of 18 miles, without having to change the wheel. Only available in combination with 19" x 8.5J '15-spoke star' design alloy wheels (PRY)	●	—	£262.50	£315.00
1BE	Sports suspension, lowered by 10mm with more firmly tuned springs and dampers for more direct contact with the road	●	S	£341.67	£410.00
1BV	S line Sports suspension with more dynamic suspension tuning and vehicle lowered by 10mm (over standard suspension)	—	●	No charge	No charge
1BK	Adaptive air suspension. Electronically controlled air suspension with infinitely variable adaptive damping system on all four wheels; automatically regulates vehicle ride height and damping; includes ride height control; different modes (Comfort, Dynamic, Auto and additional 'Lift' function for increased ground clearance) selected via Audi drive select	●	●	£1,666.67	£2,000.00
GH2	quattro® with Sports differential – the electronically regulated Sports differential distributes variable amounts of driving force to each rear wheel, ensures outstanding acceleration performance in corners and stabilises the vehicle's response to load change. It also ensures better direct steering characteristics and, thanks to less steering effort, more agile handling. Only available for 3.0 TDI quattro and 3.0 TFSI quattro	●	●	£916.67	£1,100.00

Options are subject to availability and may extend delivery.

— = Not available

● = Available

S = Standard

RRP – Recommended Retail Price.

VAT is calculated at 20% but this may alter to reflect any change in the applicable VAT rate.

Packages

Some items work well together, which is why we've created these special packages. They provide increased convenience and value by combining several of our most popular options.

Options are subject to availability and may extend delivery.

- = Not available
- = Available
- S = Standard

RRP – Recommended Retail Price.

*Online services may vary and are only available for mobile phone contracts that include a data option and only within the coverage of the mobile phone network. Additional costs to your mobile phone contract may apply. A mobile phone contract including a data flat rate is strongly recommended.

VAT is calculated at 20% but this may alter to reflect any change in the applicable VAT rate.

Order Code	SE	S line	Basic RRP	Total RRP inc VAT
WB4 Technology package – includes MMI Navigation High with MMI Touch and colour Driver's Information System (DIS), mobile telephone preparation High with online services and Audi Music Interface MMI Navigation Plus including MMI Touch. Includes (PNQ) – Hard disk navigation with topographical map display, places of interest and town models in 3D. Destinations can be entered via the speech dialogue system or MMI Touch. Incorporates MPEG4-compatible DVD player and two SDHC memory card readers (for cards of up to 32GB) Mobile telephone preparation – High with online services (9ZW) – a Bluetooth-capable mobile phone can be conveniently connected to the vehicle's internal UMTS module (provided the mobile telephone has a SIM Access profile) Online services through operation of MMI Navigation Plus include: - Point of interest search and navigation with the help of Google Earth images - Weather information - WiFi hotspots for convenient internet access using a mobile end device (e.g. laptop)* Audi Music Interface (UF7) – Universal connection for use with stereo audio sources, USB and MP3 devices including Apple iPod generation 4 onwards For more details please see pages 36, 38 and 39	•	•	£1,250.00	£1,500.00
WB1 Comfort package – Includes Audi parking system advanced (camera), Advanced key, and electrically adjustable front seats with memory function for driver's side and 4-way lumbar support Audi parking system advanced (KA2) – rear view camera image of area behind the vehicle shown on the MMI display, with dynamic display modes showing the calculated path (steer-angle dependent); includes help lines and guidelines and identification of point at which to apply opposite lock when parallel parking, reversing camera concealed in the handle strip of the tailgate Electrically adjustable front seats (PV3) – with memory function for driver's side, electrical front and rear, seat height, angle and backrest angle adjustment, 4-way lumbar support and driver's seat with memory function Advanced key (4F2) – Access and authorisation system that works through automatic data exchange between key and vehicle, allowing the driver to keep their car key in their pocket or bag at all times. Pressing the start/stop button integrated in the centre console starts and stops the engine For more details please see pages 23 and 46	•	•	£1,500.00	£1,800.00



MMI Navigation High – part of the technology package



Audi parking system advanced (camera) – part of Comfort package



Audio and communication

Stay in touch using our range of communication functions, and give each journey its own soundtrack with our advanced audio equipment.

Order Code		SE	S line	Basic RRP	Total RRP inc VAT
UF7	Audi Music Interface – universal connection for use with stereo audio sources, USB and MP3 devices including Apple iPod generation 4 onwards (iPod, iPod classic, iPod mini, iPod nano, iPod photo, iPod video, iPod touch). Provides intuitive control through the audio system and multi-function steering wheel. It also replicates the iPod display on the MMI audio screen and DIS, including track titles. The interface provides charging function (dependent on device). Includes 2 cables to connect your iPod or USB MP3 player device. Also available as part of the technology package (WB4)	●	●	£216.67	£260.00
9Q8	Driver's Information System (DIS) with 7-inch colour display – high resolution TFT colour 7" display in direct field of view of the driver. Shows information from driver assistance systems, media in use, telephone menu, gear, outside temperature and other display content of the MMI such as night vision assistant (if optionally selected). Also available as part of the technology package (WB4)	●	●	£341.67	£410.00
7A2	CD changer in the glove compartment – for 6 CDs, MP3 and WMA compatible, shock-resistant, easily accessible and each CD can be loaded and changed individually. Also supports UDF file system (Windows Vista). Music files with digital rights management (DRM) cannot be played. Not available with DVD/CD changer (6G0)	●	●	£366.67	£440.00
6G0	DVD/CD changer in glove compartment – for 6 DVDs or CDs, supports audio CDs, video DVDs and MP3, WMA, AAC, MPEG4 and playlists as well as UDF file system (Windows Vista); supports up to 4,000 tracks per medium; shock-resistant and easily accessible in the glove compartment; DVDs and CDs can be changed individually; fast forward and rewind, random playback possible. Music files with digital rights management (DRM) cannot be played. Only in combination with MMI Navigation Plus (PNQ) or technology package (WB4)	●	●	£566.67	£680.00
QV3	DAB digital radio. Receives programmes from digitally broadcast radio transmitters in addition to the range of analogue stations with better sound quality. With the DAB twin tuner, a second DAB tuner permanently searches for alternative reception frequencies of the set station, and the station list is updated at the same time. Please note – reception depends on local digital network availability	●	●	£341.67	£410.00

Options are subject to availability and may extend delivery.

- = Not available
- = Available
- S = Standard

RRP – Recommended Retail Price.

VAT is calculated at 20% but this may alter to reflect any change in the applicable VAT rate.

Audio and communication

Order Code		SE	S line	Basic RRP	Total RRP inc VAT
QV9	TV reception, analogue and digital. Reception of analogue and digital (DVB-T) uncoded television stations (MPEG-2 standard), TV picture, teletext and Electronic Programme Guide (EPG). Facility to connect 2 external AV sources via adaptor cables (available from Audi Accessories). Please note: TV reception depends on local analogue and digital network availability. No AV or TV video output when driving (audio output available when driving). Only in combination with MMI Navigation Plus (PNQ) or technology package (WB4)	●	●	£937.50	£1,125.00
QU1	TV reception (analogue, digital and DAB digital radio), reception of analogue and digital (DVB-T) uncoded television stations (MPEG-2 standard), TV picture, teletext and Electronic Programme Guide (EPG). Facility to connect 2 external AV sources via adaptor cables (available from Audi Accessories). Please note: TV reception depends on local analogue and digital network availability. No AV or TV video output when driving (audio output available when driving). Radio receives programmes from digitally broadcast radio transmitters in addition to the range of analogue stations with better sound quality. With the DAB twin tuner, a second DAB tuner permanently searches for alternative reception frequencies of the set station, and the station list is updated at the same time. Please note – reception depends on local digital network availability. Only in combination with MMI Navigation Plus (PNQ) or technology package (WB4)	●	●	£1,279.17	£1,535.00

Options are subject to availability and may extend delivery.

- = Not available
- = Available
- S = Standard

RRP – Recommended Retail Price.

VAT is calculated at 20% but this may alter to reflect any change in the applicable VAT rate.



Audio and communication

Order Code		SE	S line	Basic RRP	Total RRP inc VAT
8RY	BOSE® Surround Sound - 14 speakers including centre speaker in the dashboard and subwoofer in the spare wheel well - 12-channel amplifier with a total output of over 600 Watts - Acoustics specially tuned to the interior - Surround sound reproduction 5.1 (in conjunction with MMI Navigation Plus) and stereo recordings (CD, radio, MP3) - AudioPilot for noise-compensating volume adjustment - Powerful, precise bass reproduction	●	●	£833.33	£1,000.00
8RF	Bang & Olufsen Advanced Sound System - 15 speakers including subwoofer and centre speaker, each with their own amplifier channel for genuine 5.1 surround sound - 10-channel DSP full-digital amplifier with a total output of over 1,200 Watts, fully digitised and highly efficient 5-channel ICEPower amplifier for woofers and subwoofer - When switched on, two acoustic lenses extend from the dashboard for excellent sound rendition and perspective from all seats - Polished aluminium speaker covers - Acoustics specially tuned to the interior through the targeted use of tweeters, mid-range speakers and woofers - Speakers in encapsulated housings isolate music and telephone conversations within the vehicle for privacy – when making phone calls in handsfree mode, for instance - Automatic adjustment of volume to the driving situation Only in combination with MMI Navigation Plus (PNQ) or technology package (WB4). Please note that this option will reduce the boot space	●	●	£5,250.00	£6,300.00
PT5	Mobile telephone preparation – Low with Bluetooth and voice control. Provides handsfree connection via Bluetooth using a mobile phone aerial. Operation via MMI, the multi-function leather steering wheel or the speech dialogue system. Alternatively, it can use a cradle with charging facility for optimal reception via the external aerial, located in front centre armrest. Cradle available at extra cost – please contact your Audi Centre for phone compatibility	●	●	£262.50	£315.00
9ZW	Mobile telephone preparation – High with online services. A Bluetooth-capable mobile phone can be conveniently connected to the vehicle's internal UMTS module (provided the mobile telephone has a SIM Access profile). An additional SIM card reader is also located in the surround of the MMI Navigation Plus to allow transfer of phone book entries to the vehicle and management of call lists. Online services through operation of MMI Navigation Plus include: - Point of interest search and navigation with the help of Google Earth images - Weather information - WiFi hotspots for convenient internet access using a mobile end device (e.g. laptop)*. Up to 8 end devices can be paired at any one time Can only be ordered in conjunction with MMI Navigation Plus (PNQ) or as part of the technology package (WB4)	●	●	£762.50	£915.00
PT4	Mobile telephone preparation – High with online services and cordless handset located in front centre armrest. The cordless handset with colour display and integral SIM card reader allows passengers to make private calls, provides remote control of the telephone functions as well as convenient SMS text message function thanks to automatic word recognition. The handset is charged from a docking station integrated into the front centre armrest. Only in combination with MMI Navigation Plus (PNQ) or technology package (WB4)	●	●	£1,245.83	£1,495.00
	In combination with technology package	●	●	£483.33	£580.00

Options are subject to availability and may extend delivery.

- = Not available
 ● = Available
 S = Standard

RRP – Recommended Retail Price.

*Online services may vary and are only available for mobile phone contracts that include a data option and only within the coverage of the mobile phone network. Additional costs to your mobile phone contract may apply. A mobile phone contract including a data flat rate is strongly recommended.

VAT is calculated at 20% but this may alter to reflect any change in the applicable VAT rate.

Audio and communication

Order Code	SE	S line	Basic RRP	Total RRP inc VAT
<p>PNQ</p> <p>MMI Navigation Plus including MMI Touch. Hard disk navigation with topographical map display, places of interest and town models in 3D. Destinations can be entered via the speech dialogue system or MMI Touch. The system offers 3 alternative routes, with the ability to scroll along the selected route and manoeuvre within the map. Includes split-screen mode for route information, dynamic route guidance (TRC), intersection zoom function, motorway exits and lane recommendations in Driver's Information System (DIS). Incorporates MPEG4-compatible DVD player and two SDHC memory card readers (for cards of up to 32GB). Also includes vehicle support based on navigation data including: adaptation of transmission, lights and adaptive cruise control with Stop&Go function (depending on options fitted). This system is still available even when navigation is deactivated. This option is also available within the technology package (WB4) – please see page 34</p>	●	●	£979.17	£1,175.00
<p>KS1</p> <p>Head-up display. An optical system of mirrors projects driving-related information directly into the driver's field of vision. To prevent ghost images, a special windscreen with a wedge-shaped film is fitted. This film measures approximately 26 x 9cm in size, and driver perceives the display to be 2 to 2.5m beyond the windscreen. The display has many benefits:</p> <ul style="list-style-type: none"> - Helps to increase safety, convenience and driving pleasure - Straightforward operation via MMI - Display is height-adjustable, adjusts to ambient brightness - High resolution of up to 480 x 240 pixels - The following is displayed (depending on chosen option): <ul style="list-style-type: none"> - road speed - navigation instructions - adaptive cruise control status, distance from vehicle ahead and set speed - warning messages - infotainment lists - speed limit display 	●	●	£1,208.33	£1,450.00

Options are subject to availability and may extend delivery.

- = Not available
- = Available
- S = Standard

RRP – Recommended Retail Price.

VAT is calculated at 20% but this may alter to reflect any change in the applicable VAT rate.



MMI Navigation Plus including MMI Touch



Head-up display

Interior equipment

Specify every detail of your car's interior with this range of exclusive options.

Order Code		SE	S line	Basic RRP	Total RRP inc VAT
9AQ	Deluxe 4-zone automatic air conditioning , includes front control panel with digital display, separate temperature control for the driver and front passenger sides. There are additional controls with digital display in the rear with separately adjustable temperature and blower settings for right and left side (rear functions can also be set from the front controls.) There are additional air vents in the B-pillars and automatic recirculation by means of air quality sensor, use of residual heat, separate regulation of footwell temperature and ventilated glove compartment with a choice of 3 climates: gentle, medium and intensive	●	●	£566.67	£680.00
QQ1	Lighting package. Includes lighting for Exterior; - Courtesy lighting on the underside of the door handles and LED door handle lighting for easy entry and exit in the dark - Automatically activated when the doors are unlocked - Includes active internal door reflectors Interior; - Entrance lighting - LED technology: - 2 reading lights at front and rear - Front footwell - Inside door handles - Make-up lights - Storage compartment in the centre console - Ambient lighting of the centre console - Ambient reflected light for inside door trims	●	●	£245.83	£295.00
QQ2	Ambient lighting, in addition to interior and exterior lighting package (QQ1) , anti-glare LED illumination for the passenger compartment. Lighting for door pockets, footwells and inside door handles, reflected lighting for centre console and door inner panels to help occupants find their way around. Surround lighting for centre console (floating effect), make-up lights at front and active door reflectors, with illuminated door sill trims. Configured via MMI	●	●	£495.83	£595.00
7HB	Extended leather package. Lower part of the centre console, armrests in the doors and door pull handles in leather	●	●	£566.67	£680.00
2C7	Electrically adjustable steering column , adjustable for height and reach with auto easy entry and exit function. Must be combined with electrically adjustable front seats (PV3 or PS8)	●	●	£350.00	£420.00
3Y5	Electric sun blind for rear window, manual sun blinds for rear side windows	●	●	£391.67	£470.00
6NQ	Cloth headlining – black	●	S	£225.00	£270.00
PAC	Storage package consisting of 2 drinks holders in the rear centre armrest, luggage net for luggage compartment and two 12-Volt sockets in the rear	●	●	£87.50	£105.00
3X2	Through-load facility with removable ski/snowboard bag , for practical and safe transportation of long objects e.g. up to 4 pairs of skis or 2 snowboards; unrestricted use of the rear seats	●	●	£175.00	£210.00
6SJ	Reversible luggage compartment mat (fabric/rubber) , for luggage compartment, velour on one side, rubber on the other, folds out to cover the luggage compartment	●	●	£91.67	£110.00
9JC	Smoking package (cigarette lighter and ashtray). Replaces 12V socket in front	●	●	No charge	No charge

Options are subject to availability and may extend delivery.

- = Not available
 ● = Available
 S = Standard

RRP – Recommended Retail Price.

VAT is calculated at 20% but this may alter to reflect any change in the applicable VAT rate.



Ambient lighting package combined with Fine grain ash natural brown inlays

Exterior equipment

Make sure your car looks exactly as you want it to by selecting some of our striking options.

Options are subject to availability and may extend delivery.

- = Not available
• = Available
S = Standard

RRP – Recommended Retail Price.

VAT is calculated at 20% but this may alter to reflect any change in the applicable VAT rate.

Order Code		SE	S line	Basic RRP	Total RRP inc VAT
6XG	Exterior mirrors – heated, electrically adjustable with memory function. Only in combination with front electric seats (PV3) or Comfort seats (PS8)	•	•	No charge	No charge
6XE	Exterior mirrors – heated, electrically adjustable and electrically folding	•	•	£195.83	£235.00
6XF	Exterior mirrors – heated, electrically adjustable, electrically folding and memory function. Only in combination with front electric seats (PV3) or Comfort seats (PS8)	•	•	£195.83	£235.00
6XJ	Exterior mirrors – heated, electrically adjustable and auto-dimming	•	•	£229.17	£275.00
6XM	Exterior mirrors – heated, electrically adjustable, auto-dimming and memory function. Only in combination with front electric seats (PV3) or Comfort seats (PS8)	•	•	£229.17	£275.00
6XK	Exterior mirrors – heated, electrically adjustable, electrically folding and auto-dimming	•	•	£429.17	£515.00
6XL	Exterior mirrors – heated, electrically adjustable, electrically folding, auto-dimming and memory function. Only in combination with front electric seats (PV3) or Comfort seats (PS8)	•	•	£429.17	£515.00
4KF	Privacy glass. Dark tinted rear and rear-side windows (from B-pillar backwards)	•	•	£395.83	£475.00
PDW	Privacy glass. Dark tinted rear and rear-side windows (from B-pillar backwards) with insulation glass, and visible Vehicle Identification Number. Not in combination with privacy glass (4KF)	•	•	£708.33	£850.00
PDV	Side and rear windows in laminated glass with metal layer and with visible Vehicle Identification Number in the windscreen. Not in combination with privacy glass (4KF)	•	•	£875.00	£1,050.00



Chrome tailpipe



Exterior mirrors

Exterior equipment

Order Code		SE	S line	Basic RRP	Total RRP inc VAT
3FE	Slide-and-tilt sunroof with tinted single-glazed safety glass and infinitely adjustable sun shield, integral wind deflector, convenient closing from outside via the central locking and the radio-operated remote control	●	●	£987.50	£1,185.00
GZ2	Power door closure. Automatically pulls doors that are not completely engaged into the lock	●	●	£516.67	£620.00
4E7	Power-operated boot lid. Opens by pressing the button on the radio-operated remote control key, the button in the driver's door panel or the soft-touch button in the tailgate handle recess; closed by a button on the inside of the tailgate; includes power-assisted closing	●	●	£454.17	£545.00
0P2	Chrome tail pipes	●	S	£87.50	£105.00
1D4	Towbar. Ball head and ball joint coupling made from forged steel. Mechanically swivelling ball head, operated via Bowden cable, with indicator light on Bowden cable and display in instrument cluster to monitor secure attachment of trailer towing hitch; includes trailer stabilisation system via the Electronic Stability Programme (ESP)	●	●	£687.50	£825.00
2Z0	Removal of model and technology designation	●	●	No charge	No charge
2Z7	Removal of technology designation	●	●	No charge	No charge

Options are subject to availability and may extend delivery.

- = Not available
● = Available
S = Standard

RRP – Recommended Retail Price.

VAT is calculated at 20% but this may alter to reflect any change in the applicable VAT rate.



Safety and security

Intelligent technology designed to give you better all-round awareness and safety on the road.

Options are subject to availability and may extend delivery.

- = Not available
- = Available
- S = Standard

RRP - Recommended Retail Price.

VAT is calculated at 20% but this may alter to reflect any change in the applicable VAT rate.

Order Code		SE	S line	Basic RRP	Total RRP inc VAT
8X1	Headlight washer system	•	S	£270.83	£325.00
PX4	Bi-Xenon headlights including LED daytime-running lights, LED tail lights and headlight washers	•	S	£1,033.33	£1,240.00
8N7	High-beam assist. Variable headlight range control featuring a camera on the interior mirror which registers sources of light from other road users. The range and width of the headlight beam are continuously varied between dipped and main beam to suit ambient conditions, ensuring that the headlights provide good visibility without dazzling other road users	•	•	£116.67	£140.00
PX2	LED headlights including adaptive light and high-beam assist. Featuring dipped beam, main beam, daytime-running lights, indicators, static turning light, all-weather light and LED motorway light function; includes main beam assist for automatic switching between main and dipped beams, an all-weather light function to reduce the risk of the driver being dazzled when visibility is poor (in fog, rain or snow) and an additional motorway light which automatically increases headlight range at speeds above approximately 68mph; LED technology allows near daylight illumination of the road for increased safety and comfort; minimal energy requirements, long service life and particularly good visibility to other road users	•	•	£2,258.33	£2,710.00
7W1	Pre-sense basic Audi pre-sense is a comprehensive technical package for identifying dangers well in advance and intervening appropriately. Pre-sense basic networks the different vehicle systems enabling driving situations to be categorised and, where necessary, actions to be taken to protect the driver and passengers. These include: belt tightening, activating the hazard warning system, closing the windows and the sunroof (if fitted)	•	•	£216.67	£260.00



LED headlights including daytime-running lights

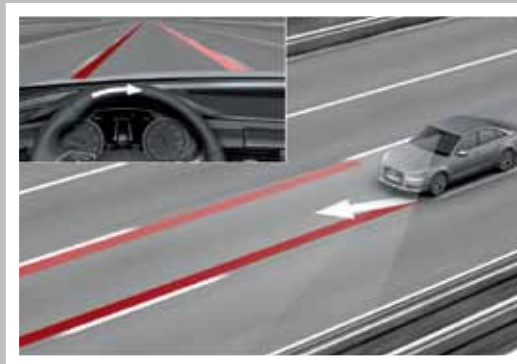

Audi active lane assist

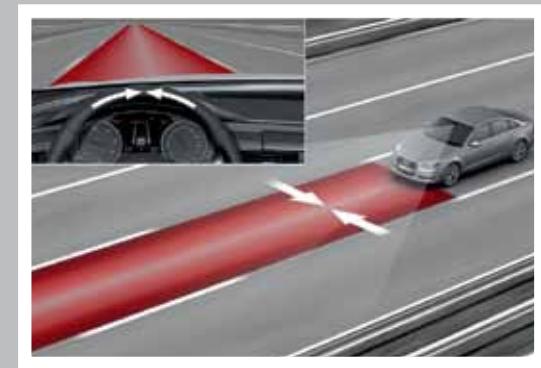

Audi active lane assist

Safety and security

Order Code	SE	S line	Basic RRP	Total RRP inc VAT
PXB	●	—	£1,608.33	£1,930.00
	—	●	£575.00	£690.00
PCB	●	●	£479.17	£575.00
PCH	●	●	£437.50	£525.00
PCD	●	●	£916.67	£1,100.00
PCG	●	●	£1,500.00	£1,800.00
PCN	●	●	£2,166.67	£2,600.00

*Where the law permits

Options are subject to availability and may extend delivery.

— = Not available

● = Available

S = Standard

RRP – Recommended Retail Price.

VAT is calculated at 20% but this may alter to reflect any change in the applicable VAT rate.

Safety and security

Intelligent technology designed to give you better all-round awareness and safety on the road.

Order Code		SE	S line	Basic RRP	Total RRP inc VAT
7X5	Park assist – searches for suitable parking spaces along the road by means of ultrasonic sensors, calculates the ideal parking path and performs the steering action virtually automatically. Steering is done by the vehicle, the driver need only accelerate and apply the brakes. Only in combination with colour DIS (9Q8)	●	●	£341.67	£410.00
KA2	Audi parking system advanced, rear view camera – image of area behind the vehicle is shown on the MMI display, with dynamic display modes showing the calculated path (steer-angle dependent); includes help lines and guidelines and identification of point at which to apply opposite lock when parallel parking, reversing camera concealed in the handle strip of the tailgate. Also available as part of the Comfort package (WB1) – please see page 34	●	●	£391.67	£470.00
QR9	Speed limit display – the prevailing speed limit can be simply read on the Driver's Information System (DIS). Should the camera fail to see a sign properly, the speed limit from the data for the navigation system – if fitted – will be shown instead. The advantages: - Display of the speed limits currently registered, which can be called up in the Driver's Information System at any time - Display can be called up in every instrument cluster view and in the head-up display (optional equipment) - Camera-based system is also capable of detecting temporary speed restrictions in roadworks and on digital displays (e.g. over motorways) within the system limits - Display of national speed limits for Western European countries Only available in conjunction with MMI Navigation Plus (PNQ or WB4), and with active lane assist (PCB), Audi side assist (PCD) or adaptive cruise control (PCG/PCN)	●	●	£129.17	£155.00
9R1	Night vision assistant with pedestrian detection – a thermal imaging camera (remote infrared with resolution of 320 x 240 pixels) registers heat dissipation in front of the vehicle and represents this image in the Driver's Information System (DIS). Image recognition software highlights people detected in the darkness and a warning bell is sounded if the system classifies them as being at risk. Warning can also be shown in the head-up display (optional equipment). System operation may be restricted in too much ambient light, high humidity and high night temperatures (over 28 degrees). Only in combination with colour DIS (9Q8)	●	●	£1,750.00	£2,100.00
4F2	Advanced key. Access and authorisation system that works through automatic data exchange between key and vehicle, allowing the driver to keep their car key in their pocket or bag at all times. To unlock and open, simply lift the exterior door handle. The door is locked by pressing the button on the handle. Pressing the start/stop button integrated in the centre console starts and stops the engine. Also available as part of the Comfort package (WB1) – please see page 34	●	●	£566.67	£680.00
VC1	Garage door opener (HomeLink®*). Programmable radio remote control, with buttons integrated into the front roof module; can be used for opening garages and exterior gates	●	●	£204.17	£245.00
4X4	Rear side airbags. For the outer rear seats, incorporated into the seat backrests; supplement the side impact protection in the doors and the head airbag system	●	●	£312.50	£375.00
7G9	Tracking preparation	●	●	£91.67	£110.00
OM5	75-litre fuel tank	●	●	£95.83	£115.00

Options are subject to availability and may extend delivery.

*Homelink® is a registered trademark of Johnson Controls. For information on compatibility, visit www.homelink.com.

– = Not available
● = Available
S = Standard

RRP – Recommended Retail Price.

VAT is calculated at 20% but this may alter to reflect any change in the applicable VAT rate.

Steering wheels

Order Code		SE	S line	Basic RRP	Total RRP inc VAT
2ZM	4-spoke leather-trimmed multi-function steering wheel – heated (no paddles, manual models only)	●	–	£33.33	£40.00
1XW	3-Spoke leather-trimmed multi-function Sports steering wheel (manual models only)	●	S	£95.83	£115.00
1XX	3-spoke leather-trimmed multi-function Sports steering wheel with gear-shift paddles (automatic models only)	●	S	£95.83	£115.00
1XT	3-spoke leather-trimmed multi-function Sports steering wheel – heated with, gear-shift paddles (automatic models only)	●	–	£262.50	£315.00
		–	●	£166.67	£200.00

Options are subject to availability and may extend delivery.

- = Not available
- = Available
- S = Standard

RRP – Recommended Retail Price.

VAT is calculated at 20% but this may alter to reflect any change in the applicable VAT rate.



Service Plan

Choosing an Audi Service Plan provides an easy way to cover all your car's scheduled servicing with a convenient monthly payment plan. It can take care of everything from fluid and filter changes to your full service, ensuring you retain a full Audi service history. There are no servicing bills to plan for and you'll continue to benefit from today's prices for the length of your agreement.

Order Code		SE	S line	Basic RRP	Total RRP inc VAT
-	3-Service Plan. Comprehensive package covering servicing costs for 3 services or 30,000 miles (whichever occurs sooner). Visit audi.co.uk/serviceplans for full details including terms and conditions	●	●	£33.33	£40.00
-	5-Service Plan. Comprehensive package covering servicing costs for 5 services or 50,000 miles (whichever occurs sooner). Visit audi.co.uk/serviceplans for full details including terms and conditions	●	●	£41.67	£50.00

Warranty

Options are subject to availability and may extend delivery.

- = Not available
● = Available
S = Standard

*Prices are based on the Audi Fixed Inspection Service Schedule and 10,000 miles per annum or less. For more information on the Service Schedule, please see page 53.

**Only available when ordering your new Audi A6. Please speak to your Audi Centre for full details.

RRP - Recommended Retail Price.

VAT is calculated at 20% but this may alter to reflect any change in the applicable VAT rate.

Order Code		SE	S line	Basic RRP	Total RRP inc VAT
-	Audi Warranty, covering you for unlimited mileage in the first 2 years of ownership, and up to 60,000 miles in the third year. Transferable between owners**	●	●	No charge	No charge
EA6	Audi Warranty, covering you for up to 4 years or 75,000 miles, whichever comes soonest. Cover includes a 2-year unlimited mileage warranty, and up to 75,000 miles in the third and fourth years. Transferable between owners**	●	●	£466.67	£560.00
EA9	Audi Warranty, covering you for up to 5 years or 90,000 miles, whichever comes soonest. Cover includes a 2-year unlimited mileage warranty, and up to 90,000 miles in the third, fourth and fifth years. Transferable between owners**	●	●	£1,112.50	£1,335.00

Merchandise

From the enthusiasts' motorsport collection to the sophisticated Audi collection, there's a wide variety of adults' and children's clothing, lifestyle accessories and collectables, all of which bear the Audi name.

Please speak to a member of our team at your local Audi Centre to see the full Audi collection and to place an order. A selection of Audi merchandise is also available to buy from audi.co.uk/merchandise.



Audi kids



Bags and leather goods



Clothing



Motorsport



Sport and travel



Model cars

Accessories

Choosing an Audi isn't just a matter of deciding on the model you want; it's about creating a car that suits your needs perfectly. And that's why we've developed a whole range of accessories to enhance your A6, enabling you to customise it down to the last detail. Like your Audi, all these accessories are developed to the highest possible standards. And they're all available exclusively from Audi. To find out more, just visit your local Audi Centre.

Warranty

All of the accessories available on the A6 are covered by a three-year warranty* if they are ordered and included in the purchase price of the car at date of delivery. Any accessories ordered and installed after delivery include a two-year warranty.*



Sport and design



Transport and touring



Entertainment and communication

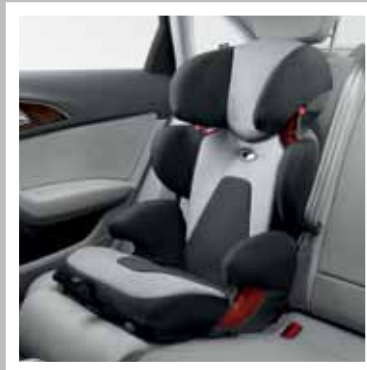

Family



Comfort and protection



Safety and security

*Excluding Road Angel products.

Audi Accessories warranty terms and conditions can be found at audi.co.uk

A6 Saloon technical data

Petrol

Engine	3.0 TFSI quattro
Transmission	7-speed S tronic
Cylinder	6-cylinder
Displacement, cubic cm (valves per cylinder)	2995 (4)
Max. power, ¹ PS	300/5250-6500
Max. torque, Nm at rpm	440/2900-4500
0-62mph acceleration, seconds	5.5
Top speed, mph	155*
CO ₂ emissions, ² g/km	190
Benefit in kind (BIK)%	27%
Fuel consumption, mpg (l/100km) Urban	26.2 (10.8)
Fuel consumption, mpg (l/100km) Extra Urban	42.8 (6.6)
Fuel consumption, mpg (l/100km) Combined	34.4 (8.2)
ABI insurance group 1-50 ⁺	TBC
Unladen weight, ³ kg	1740
Gross weight limit, kg	2350
Roof load limit/nose weight, kg	100/85
Max trailer load unbraked, ⁴ kg	750
Max trailer load with 12% gradient, ⁴ kg	2100
Max trailer load with 8% gradient, ⁴ kg	2100
Luggage compartment capacity, rear seats upright, litres	530
Fuel tank capacity approx, litres	65

*Electronically limited

**Loaded up to roof with rear seat folded down.

⁺Highest insurance group rating shown. Group may be lower dependent on trim level. Please visit www.thatcham.org/abigrouprating for details.

¹The given value was obtained in accordance with the specified measurement procedure (the respective current version of the Directive 80/1269/EEC).

²The given values were calculated in accordance with the specified measurement procedure (the respective current version of Directive 80/1268/EEC). This information does not relate to a single vehicle and does not comprise part of the offer but is merely intended for the purpose of comparison between the different vehicle types.

³Vehicle's unladen weight without driver (calculated in accordance with the current version of Directive 80/1268/EEC). The fitting of additional equipment may increase the vehicle's unladen weight and drag coefficient, whereupon the potential carrying capacity and top speed will be correspondingly reduced.

⁴The engine's power output always goes down with increasing altitude. At 1,000m above sea level, and for every additional 1,000m, deduct 10% from the weight of the outfit (trailer load limit + gross weight of the towing vehicle).

Please note: The maximum power output figures are quoted in PS (or Pferdestärke, which is the metric equivalent of brake horsepower). To convert to brake horsepower, divide the PS figure by 1.0139.

Diesel

Engine	3.0 TDI	3.0 TDI quattro
Transmission	multitronic	7-speed S tronic
Cylinder	6-cylinder	6-cylinder
Displacement, cubic cm (valves per cylinder)	2967 (4)	2967 (4)
Max. power, ¹ PS	204/3750-4500	245/4000-4500
Max. torque, Nm at rpm	400/1250-3500	500/1400-3250
0-62mph acceleration, seconds	7.2	6.1
Top speed, mph	149	155*
CO ₂ emissions, ² g/km	137	158
Benefit in kind (BIK)%	19%	23%
Fuel consumption, mpg (l/100km) Urban	47.1 (6.0)	39.2 (7.2)
Fuel consumption, mpg (l/100km) Extra Urban	60.1 (4.7)	53.3 (5.3)
Fuel consumption, mpg (l/100km) Combined	54.3 (5.2)	47.1 (6.0)
ABI insurance group 1-50 ⁺	TBC	TBC
Unladen weight, ³ kg	1645	1720
Gross weight limit, kg	2225	2330
Roof load limit/nose weight, kg	100/85	100/85
Max trailer load unbraked, ⁴ kg	750	750
Max trailer load with 12% gradient, ⁴ kg	1800	2000
Max trailer load with 8% gradient, ⁴ kg	1900	2100
Luggage compartment capacity, rear seats upright, litres	530	530
Fuel tank capacity approx, litres	65	65

A6 Saloon dimensions

The technical drawings opposite show the exact dimensions of the Audi A6 Saloon, so you can check everything – from whether the car will fit in your garage to whether your luggage will fit in the boot.

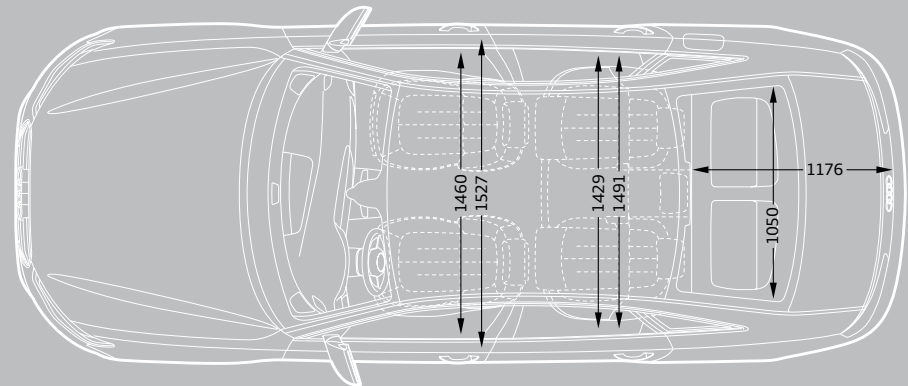
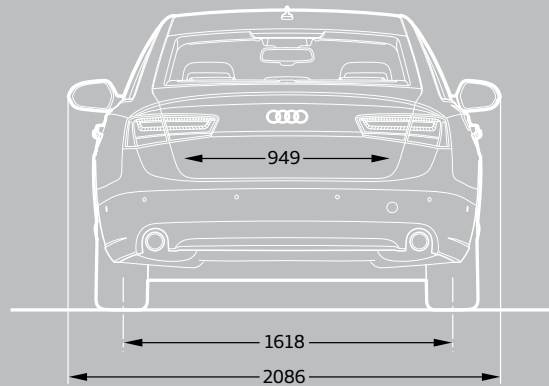
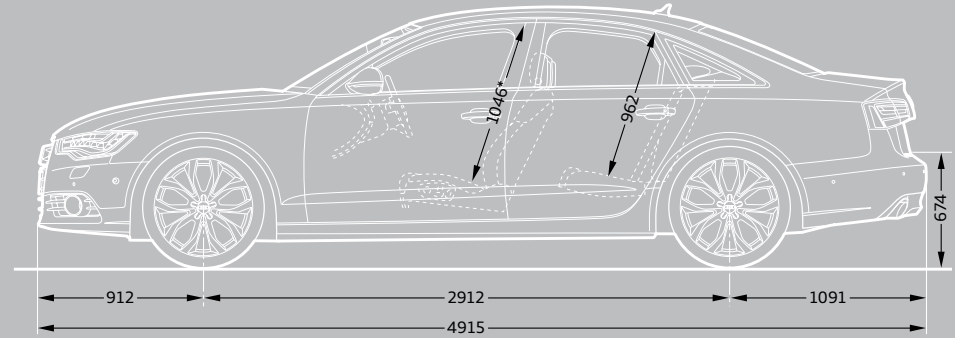
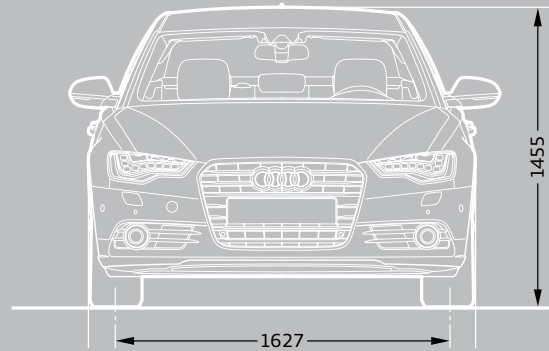

*Maximum headroom.

Dimensions in millimetres.

Turning circle approx 11.9m.

Dimensions were measured with vehicle at unladen weight. Luggage compartment volume in litres: 535/1390 (measured by the VDA standard test method using 200 x 100 x 50mm blocks; second value: with rear seat folded down).

Additional information

CO₂ data and information

CO₂ emissions-based Vehicle Excise Duty

Vehicle Excise Duty (Road Fund Licence) is based upon the amount of Carbon Dioxide (CO₂) a vehicle emits, measured in grams per kilometre (g/km). First year VED rates apply to the first year of ownership. Annual VED rates apply thereafter. The DVLA has created thirteen categories:

Petrol and Diesel engines	First year	Annual rate (second year onwards)
A - up to 100g/km	£0.00	£0.00
B - 101 to 110g/km	£0.00	£20.00
C - 111 to 120g/km	£0.00	£30.00
D - 121 to 130g/km	£0.00	£90.00
E - 131 to 140g/km	£110.00	£110.00
F - 141 to 150g/km	£125.00	£125.00
G - 151 to 165g/km	£155.00	£155.00
H - 166 to 175g/km	£250.00	£180.00
I - 176 to 185g/km	£300.00	£200.00
J - 186 to 200g/km	£425.00	£235.00
K - 201 to 225g/km	£550.00	£245.00
L - 226 to 255g/km	£750.00	£425.00
M - over 255g/km	£950.00	£435.00

Vehicle Excise Duty (VED) rates correct at time of going to print, but these may alter to reflect any change in the applicable VED rate

Servicing tailored to your needs

Regular servicing is key to safeguarding your Audi's performance and a full Audi service history could help you preserve the future re-sale value. To make servicing easy, the Audi Service Schedules have been designed to work with your individual driving style and vehicle.

There are two schedules available and your Audi Centre will advise which schedule is most suited to your needs. The conventional fixed Audi Inspection Service schedule has fixed intervals for the Oil-change and Inspection Service that are based on time

and distance, whichever comes first. With the Audi LongLife Service schedule, sensors take account of driving style and conditions in which the vehicle is used to indicate when the Oil-change Service is required. Oil-change Service intervals are therefore variable and are conveniently indicated via the on-board service interval display.

Fixed Inspection Service Schedule

	Vehicle usage:
Mileage	Less than 10,000 miles per annum
Type of journey	Mainly city/town centre driving. Short journeys
Conditions	Frequent cold starts. High engine loading - e.g. frequent hill climbs, vehicle fully loaded, towing
Driving style	Uneconomical - e.g. heavy acceleration, heavy braking, constant changes in speed, constant use of high revs, 'sporty' driving
	Service Intervals:
Oil-change Service	Fixed to every 9,000* miles/1 year
Inspection Service	Fixed to every 19,000* miles/2 years

Variable LongLife Service Schedule

	Vehicle usage:
Mileage	More than 10,000 miles per annum
Type of journey	Motorway and main road driving. Mainly longer distance journeys. Constant speeds
Conditions	Normal engine loading - e.g. with little or no towing, with little or no hill climbs. Normal vehicle loading
Driving style	Moderate acceleration, moderate braking, engine revs mainly below 3,000
	Service Intervals:
Oil-change Service	Variable to a maximum of every 19,000* miles/2 years
Inspection Service	Fixed to every 19,000* miles/2 years

*As indicated by the service interval display. Mileages are approximate as the Service Indicator system uses kilometres as its distance measurement.

Additional information

Welcome to Audi

By placing an order for your Audi, you're choosing to get behind the wheel of one of the most sophisticated cars on the road. And because we believe the service we offer should be just as advanced, we wanted to let you know exactly what you can expect from us, now and in the future.

We've agreed a set of standards with all our Centres, which governs the way we do business with you. It outlines the kind of service we promise to deliver for every customer, right down to filling each new Audi we sell with half a tank of fuel.

So whether you're interested in the date your car will arrive in the UK or the way we'll dispose of non-biodegradable materials after we service your Audi, you can have total confidence in us.

Audi Promise

Audi Centres

We guarantee that all of our Centres will be open as follows:

Sales: Monday to Friday 9am–6pm

Saturday 9am–5pm

Service: Monday to Friday 8am–6pm

Saturday 8.30am–1pm

Sunday opening is at local discretion.

New car delivery

Once we've confirmed a delivery date for your car, we'll keep you informed of progress. Subject to reasonable notice, we'll then deliver it to a place of your choice, whether that's your home or place of work. In the unlikely event of a delay, we'll provide a courtesy car to minimise inconvenience and keep you mobile.

The experts in Vorsprung durch Technik

Would you entrust your Audi to anyone who hasn't been regularly trained to Audi standards? Our network of Audi Approved Master Technicians have undergone an impressive 100,000 hours of training over a 10-year programme to ensure they have the latest technical expertise for maintaining and servicing your Audi. All of our Service Advisors undergo a specialist induction and training to ensure they are Audi professionals and able to talk to you about any issues you may have with your Audi vehicle. What's more, we have so much expertise and experience in looking after Audi vehicles that we are able to make a note of your mileage and the state of your vehicle as and when we see it and predict when certain key events may occur. As part of our commitment to you, we will notify you in plenty of time so you can make an appointment with us.

Your convenience comes first

At Audi you can choose from a range of convenient services that suit your needs. Why not book a 'service while you wait' appointment* and enjoy our complimentary refreshments while your car is with us? Or, if you need to be mobile, take advantage of one of our courtesy cars which we can even collect and deliver to you.* We guarantee we can service your Audi within 5 days without a courtesy car, or within 10 days if you need transport. We will also ensure your car is returned to you with a full valet.

Audi Genuine Parts

Would you put a part into your Audi that wasn't the same quality as the factory fitted original? You can rest assured that only Audi Genuine Parts will be used on your vehicle. What's more, Audi parts and labour come with a 2-year guarantee.** We stock a wide variety of parts, so we are well covered. However, if we don't have a part in stock at our Centre we have the back-up of parts at other Audi Centres, at our national warehouse and our factory and can usually source the relevant part very quickly.

We don't like surprises either

We believe strongly in transparency and there will be no hidden costs. For added peace of mind, we will give you a quotation over the phone for the work you have requested and email you the price confirmation. We'll consult you if any additional work on your car is needed when it is with us. We won't carry out any extra work without asking your permission first.

The Audi Stamp

Regular servicing is key to safeguarding your Audi's performance and a full Audi service history could help you preserve the future re-sale value of your car. Only the Audi Stamp will prove your approved Audi service history.

Getting better every time

We continually gather feedback from our Audi Trained Technicians, as well as our customers, to ensure our vehicles are running as they should. Whenever we see an Audi for a service, we connect it directly to our headquarters in Ingolstadt which enables us to check your car's software and make sure it's as up-to-date as possible. If the factory has released a software upgrade for your model, it can be applied immediately – improving anything from your car's efficiency to the precision of its parking system.

Environmental commitment

We promise to dispose of all non-biodegradable materials from your vehicle in a responsible manner

*Subject to availability.

**Excludes wear and tear.

Pricing information

Pricing

Prices and specifications given are correct at the time of printing. Always check details with your Audi Centre, as Audi policies are continually developing. We reserve the right to change prices or specifications at any time.

All prices are subject to VAT, currently charged at 20% but this may alter to reflect any change in the applicable VAT rate.

Delivery charges and number plates are not included in the vehicle price.

Delivery charge	£471.66
Number plate	£20.00
VAT	£98.34
Total	£590.00

Audi Roadside Assistance

Your new car comes complete with 3 years' complimentary roadside assistance and recovery across the UK provided by RAC Motoring Services. Also included is roadside assistance throughout Europe, managed by RAC Motoring Services. For further information and terms conditions please visit audi.co.uk

Audi Customer Care

Every new Audi benefits from the comprehensive Audi Customer Care Package, which comprises:

- ▶ A 3-year Audi warranty, which covers you for unlimited mileage in the first 2 years of ownership, with a full mechanical and electrical warranty which covers you for up to 60,000 miles in the 3rd year

- ▶ A 3-year paint warranty
- ▶ A 12-year anti-corrosion warranty
- ▶ 3 years' UK roadside assistance and recovery

You also have the option when ordering your new car of choosing a 4-year or 5-year Audi warranty. Speak to a member of the sales team for more information.

Audi Tax-Free Sales

If you are entitled to purchase a vehicle free of VAT, normally through Military or Diplomatic privilege, please contact your local Audi Centre for full details.

Should you have any difficulty obtaining the information you require, please call Freephone 0800 585878.

Audi Finance

Audi Finance specialise in providing funding solutions for Audi drivers. Whether your Audi is for private or business use, there is a range of funding options to choose from.

Below is the full range of finance products.

- ▶ Solutions – a Personal Contract Plan
- ▶ Hire purchase
- ▶ Lease purchase
- ▶ Finance lease
- ▶ Contract hire

With all products, you can choose a fixed-cost maintenance plan designed to help you budget accurately.

No matter what Audi model you choose, your local Audi Centre can provide you with a personalised quote which could fit your budget and motoring needs.

Audi Finance is a trading name of Volkswagen Financial Services (UK) Limited. An offer of finance depends on certain conditions. Available to people over 18 in the UK only.

Audi Insurance

We want you to start enjoying your new car from day one and thanks to Audi Insurance complimentary seven day cover, you can.

Call free on 0800 316 7893 (lines are open Monday to Friday 8am - 9pm, and Saturday 9am - 5pm), provide a few details and a cover note will be sent to your Audi Centre. They will then tax your car and you can drive it away.

Audi Insurance is a trading name of Volkswagen Insurance Service (Great Britain) Limited, an appointed representative of Volkswagen Financial Services (UK) Limited, Brunswick Court, Yeomans Drive, Blakelands, Milton Keynes MK14 5LR. Registered in England number 2835230. Audi Insurance is sold, underwritten and administered by Allianz Insurance plc registered in England number 84638. Registered office 57 Ladymead, Guildford, Surrey GU1 1DB. Volkswagen Financial Services (UK) Limited and Allianz Insurance plc are authorised and regulated by the Financial Services Authority. Volkswagen Financial Services (UK) Limited and Allianz Insurance plc are not part of the same corporate group.

Audi UK

Customer Services
Selectapost 29
Sheffield
S97 3FG
0800 699888
audi.co.uk

Specifications and prices subject
to change without notice.

© Audi (UK)

Printed in the UK
Edition 1.0 01/11
2011 model year

Images are for illustrative purposes only.