



## The Audi Q5

Pricing and Specification Guide  
Valid from April 2011

# Personalising your Audi Q5

This guide has been designed to help you tailor and price your Audi Q5 quickly and logically. At the back, you will find information on CO2 emissions-based vehicle excise duty and other services offered by Audi, including Finance and Insurance. Alternatively, you can go to [audi.co.uk](http://audi.co.uk) and configure your Audi Q5 online.

## The Audi Q5

|              |    |
|--------------|----|
| Efficiency   | 8  |
| Engines      | 10 |
| Transmission | 11 |
| quattro®     | 12 |

## Model details and prices

|  |    |
|--|----|
| Standard model equipment               | 14 |
| SE model equipment                     | 15 |
| S line model equipment                 | 16 |
| S line Special Edition model equipment | 17 |
| Model prices                           | 18 |

|                       |    |
|-----------------------|----|
| <b>Audi exclusive</b> | 20 |
|-----------------------|----|

## Colour and upholstery

|                       |    |
|-----------------------|----|
| Paint                 | 24 |
| Upholstery            | 26 |
| Colour and trim guide | 30 |
| Inlays                | 36 |

## Options

|                              |    |
|------------------------------|----|
| Wheels, tyres and suspension | 38 |
| Packages                     | 42 |
| Audio and communication      | 44 |
| Interior equipment           | 46 |
| Seats                        | 50 |
| Exterior equipment           | 51 |
| Safety and security          | 52 |
| Steering wheels              | 54 |
| Service Plan and warranty    | 55 |
| Off-road capabilities        | 56 |
| Merchandise                  | 57 |
| Accessories                  | 58 |

## Technical details

|                        |    |
|------------------------|----|
| Technical data         | 59 |
| Dimensions             | 61 |
| Additional information | 62 |
| Pricing information    | 64 |





## Vorsprung durch Technik

Three words that express the very essence of Audi. Vorsprung durch Technik isn't a slogan. It's our way of seeing the world. It is the driving force behind our history of innovation that continues into the 21st century. Indeed, many technologies that Audi pioneered remain in our cars today. Some are milestones in the history of the motorcar.

From our beginnings in 1899, to the Auto Union team's Grand Prix successes in the 1930s and our more recent wins at Le Mans, we have always been at the forefront of the motor industry.

Vorsprung durch Technik makes us who we are. To see more of its influence, just read on.

## The streamlined Audi Q5

The Audi Q5 isn't a typical SUV: it combines the poise and athleticism of a coupé with the practicality and space of a much larger car. It also offers the exceptional grip of quattro® all-wheel-drive, 17-inch alloy wheels and some other advanced features you might not expect. There's a choice of direct-injection TDI® and FSI® engines, a five-link front suspension and an optional S tronic® transmission – ensuring that the Audi Q5 delivers all the handling and performance its coupé-like shape suggests.





## Efficiency

At Audi, doing less is something we're trying to do more of. We're working to use less fuel, release less CO<sub>2</sub> and waste less energy. It's why we've incorporated a number of more efficient technologies into the Audi Q5.

### Recuperation

When a vehicle brakes, the discs convert the kinetic energy into thermal energy, which is wasted as it cannot be used. With a recuperation system like the one in the Audi Q5, the kinetic energy is converted into useful electrical energy. The way it works is simple. While the car is coasting or braking, the alternator voltage is raised above the level of the basic electrical system, which enables the alternator to generate electrical energy and store it temporarily in the battery. When the vehicle accelerates, this energy is used to relieve the load on the alternator, resulting in a fuel saving of up to 3%.





### **Aerodynamics**

A car's shape can have a big impact on its efficiency. It's why we've worked to make the Audi Q5 as aerodynamic as possible.

### **Automatic Start-Stop function**

In heavy traffic, your car still uses fuel and releases CO<sub>2</sub>, even when it's stationary. The automatic Start-Stop function counteracts this problem by switching off the engine when your car comes to a standstill. As soon as you touch the clutch, the car restarts. In conjunction with the 2.0 TDI® and 2.0 TFSI® (manual transmission only) engines, it helps save up to 0.4 litres of fuel every 100km.



## Engines

### Petrol

FSI® direct-injection technology is a unique Audi innovation that was originally developed for the Le Mans 24-hour endurance race to deliver more power and torque, as well as enhanced fuel efficiency. Precisely the right amount of fuel and air are injected into the combustion chambers, enabling the engine to ‘breathe’ more easily. It results in reduced heat loss and increased output, with around a 15% reduction in fuel consumption and significantly lower exhaust emissions. We’ve also developed TFSI®, with turbocharging, which combines FSI® technology with forced induction – giving cars an extra injection of power.

### Diesel

We introduced TDI® to the roads in 1989, marking a departure from the noisy, fuel-thirsty diesel engines of the past. And since then, we’ve continuously refined it, recently developing common-rail technology. With this system, a series of piezo injectors use electrical charge to precisely control the amount of fuel injected into the engine. As well as reducing noise, this allows combustion to happen at a lower temperature, with less oxygen, which lowers emissions.





## Transmission

### **S tronic®**

Driving is all about thinking ahead, which is just what the S tronic® dual-clutch transmission does. It works almost as two separate systems, one engaging the odd-numbered and the other the even-numbered gears. So when you're accelerating in second, it has third gear waiting for you. And once you make the switch, it's already thinking about fourth. With two clutches working together, you can change gears almost instantly while experiencing smooth, uninterrupted power.

## quattro®

It's the technology that gave us the edge on the rally circuit ever since it was first introduced 30 years ago, bringing victory for the Audi quattro® on its very first outing. It's called quattro® permanent all-wheel-drive. In this system, four permanently driven wheels deliver better acceleration, road-holding and safety, while asymmetric dynamic torque distribution intelligently controls the flow of power to the front and rear axles.

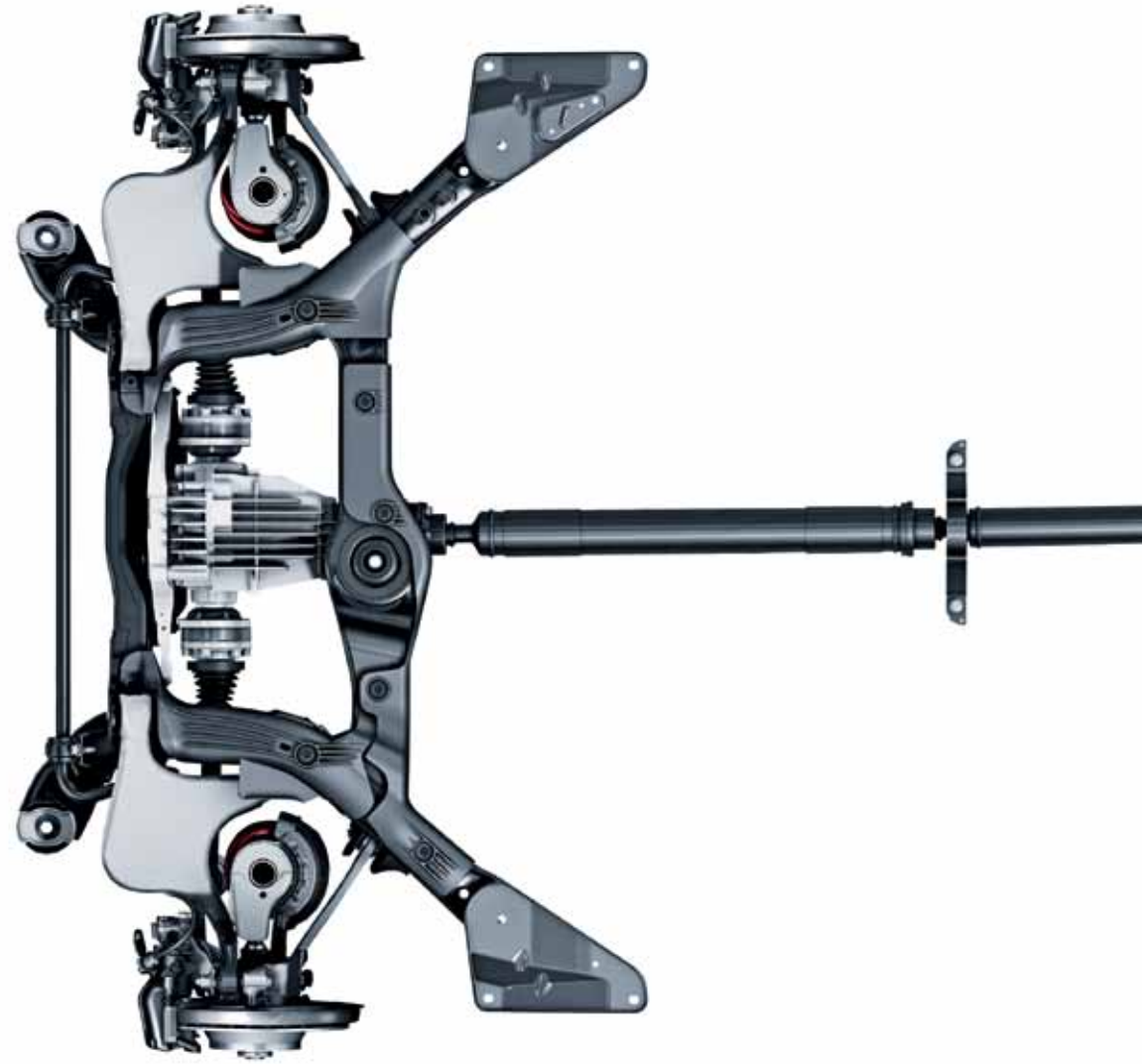

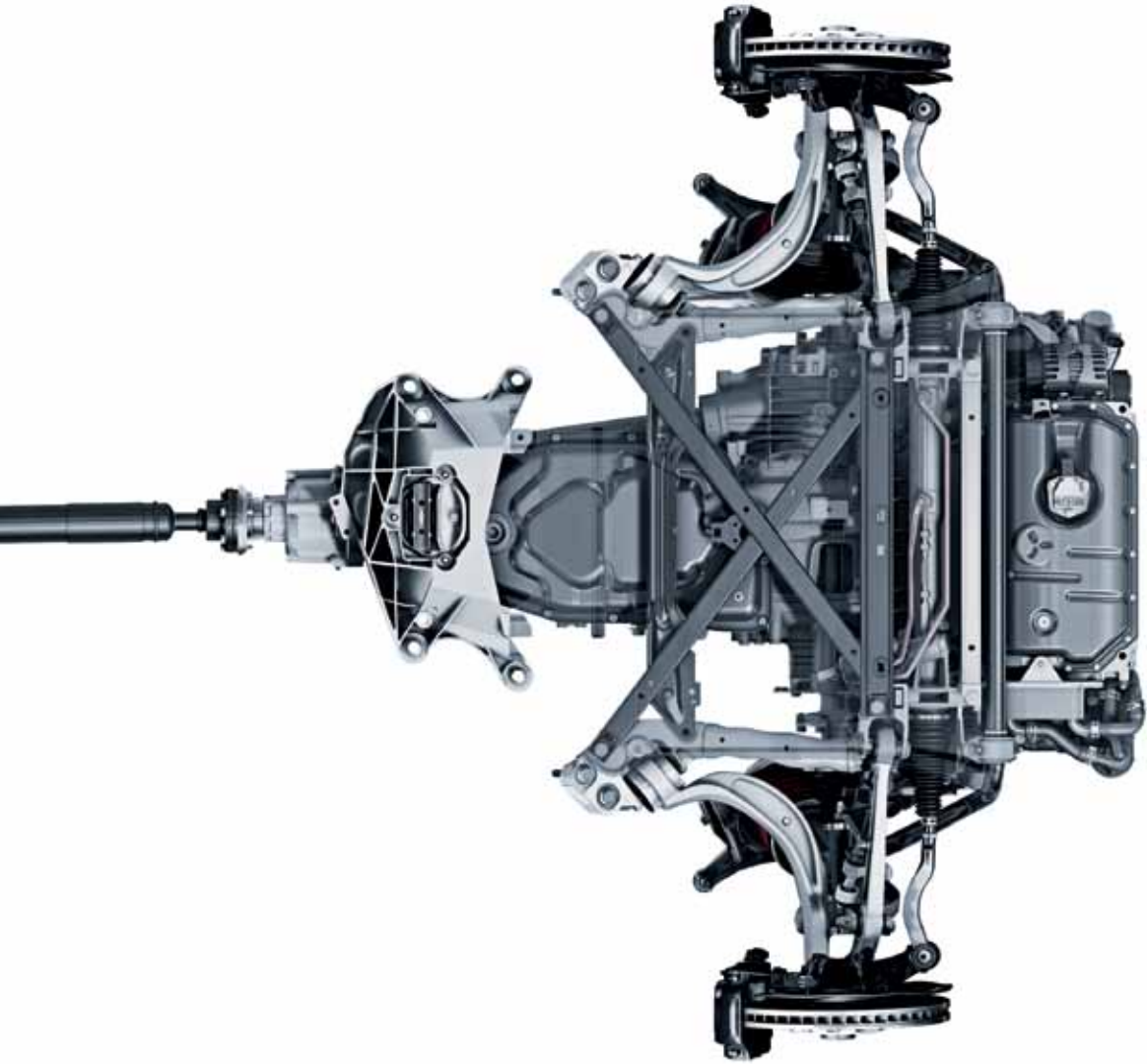

It means that the Audi Q5 can 'read' the road, sensing changes in the surface beneath the wheels and adjusting their grip accordingly. So when conditions get a little more demanding – in particular, when you go off-road – quattro® adapts, putting all the force of the Audi Q5's engine precisely where it's needed to handle the change in terrain.

# Standard model equipment

All Audi Q5 models have the following items of standard equipment

## Engine

Automatic Start-Stop function for greater fuel and CO<sub>2</sub> efficiency (only available on the 2.0 TFSI 180PS and 211PS and 2.0 TDI 143PS and 170PS manual models)

Recuperation for optimal energy utilisation

Energy-saving tips feature in Driver's Information System, including gear-shift indicator (if fitted)

Misfuelling inhibition for diesel models

## Wheels, tyres and suspension

17" x 8J '6-spoke' design alloy wheels with 235/65 R17 tyres

Tyre mobility system

Servotronic speed-related power-assisted steering

## Audio and communication

6 speakers (80 Watts)

Audi Concert radio – CD player with MP3 compatibility and 6.5" colour centre console screen, including AUX-IN socket

Multi Media Interface

## Interior equipment

1-zone climate control

4-spoke leather steering wheel

Driver's Information System (DIS) – red and black

Front and rear electric windows

Front and rear floor mats

Micrometallic inlays

## Safety and security

Anti-theft device – Thatcham category 1 approved

Electromechanical parking brake

First-aid kit

Front and rear fog lights

Front and rear ISOFIX seats with airbag de-activation switch for front passenger seat

Halogen headlights with daytime-running lights

Hill descent assist (please see page 56 for further information) with off-road Electronic Stability Programme (ESP)

Side airbags for driver and front passenger seats

Tool kit and car jack

Warning triangle

## Seats

3-point seat belt with belt-force limiters for all 5 seats

Split-folding rear seat

Steppe cloth upholstery

## Exterior equipment

Aluminium roof rails with roof bar detection (automatically adjusts the ESP to react to the higher centre of gravity when roof bars are in place)

Black exterior window trims

Contrasting bumpers

Door mirrors – electrically adjustable and heated

Stone grey finish grille

Rear spoiler

Roof bars and storage bag



17" x 8J '6-spoke' design alloy wheels



Halogen headlights with daytime-running lights



Door mirrors – electrically adjustable and heated



Front and rear fog lights

# SE model equipment

## In addition to Standard model equipment

**Basic RRP**  
£1,958.33

**Total RRP inc VAT**  
£2,350.00

### Wheels, tyres and suspension

18" x 8J '10-spoke V' design alloy wheels with 235/60 R18 tyres and locking wheel bolts

### Audio and communication

Audi sound system – 10 high-performance loudspeakers (180 Watts) and 6-channel amplifier

### Seats

Milano leather upholstery

### Interior equipment

4-spoke multi-function leather steering wheel

Aluminium silver inlays

Colour Driver's Information System (DIS) with efficiency programme

Deluxe 3-zone climate control with separate air distribution and digital temperature displays for driver, front passenger and rear passenger compartment (3.0 TDI and 3.2 FSI only)

Front centre armrest including 12-Volt socket

### Exterior equipment

Aluminium window trims framing the exterior side windows

Chrome-plated exhaust tailpipe surrounds (3.0 TDI® and 3.2 FSI® only)

Full body-coloured bumpers

High-gloss painted grille on 3.0 TDI® and 3.2 FSI®. All other models come with stone grey finish grille

### Safety and security

Auto-dimming rear-view mirror including acoustic windscreen

Automatic headlight operation

Automatic windscreen wiper operation

Rear acoustic parking system



18" x 8J '10-spoke V' design alloy wheels



Aluminium silver inlays



Driver's Information System (DIS)



4-spoke multi-function leather steering wheel

# S line model equipment

## In addition to SE model equipment

**Basic RRP**  
£1,829.17

**Total RRP inc VAT**  
£2,195.00

### Wheels, tyres and suspension

19" x 8J '5-spoke' design alloy wheels with 235/55 R19 tyres and locking wheel bolts  
Standard suspension (S line Sports suspension available as a no-charge option)

### Seats

Front Sports seats in Milano leather with electric lumbar support (S line embossed)

### Interior equipment

Black headlining  
Matt-brushed aluminium inlays  
S line 3-spoke leather multi-function steering wheel (with gear-shift paddles for S tronic®)  
S line sill plates and aluminium loading strip for the boot

### Exterior equipment

Chrome fog light surround  
Chrome-plated exhaust tailpipe surrounds  
Diffuser in Platinum grey optic  
Rear LED lights  
S line exterior styling package including:  
- S line badges on front wings  
- S line front bumper  
- S line rear diffuser  
- S line side skirts  
- S line grille with chrome vertical bars  
Xenon headlights with automatic headlight-range adjustment, headlight washers and LED daytime-running lights



19" x 8J '5-spoke' design alloy wheels



S line 3-spoke leather multi-function steering wheel



Matt-brushed aluminium inlays



Chrome-plated exhaust tailpipe surrounds

# S line Special Edition model equipment

In addition to S line model equipment

**Basic RRP**  
£1,062.50

**Total RRP inc VAT**  
£1,275.00\*

\*Valid for new vehicle orders placed up to and including 30 September 2011. Subject to availability.

## Wheels, tyres and suspension

20" x 8.5J '5-double-spoke off-road' design alloy wheels with 255/45 R20 tyres

## Audio and communication

Bluetooth interface  
Bang & Olufsen sound system  
DAB radio

## Exterior equipment

Electric tailgate



20" x 8.5J '5-double-spoke off-road' design alloy wheels



Bang & Olufsen sound system



Mobile telephone preparation – Low



## Audi Q5 Standard

| Engines          | Power | Transmissions  | CO <sub>2</sub> g/km | Basic RRP  | Total RRP inc VAT | Recommended OTR |
|------------------|-------|----------------|----------------------|------------|-------------------|-----------------|
| 2.0 TFSI quattro | 180PS | 6-speed manual | 188                  | £22,425.00 | £26,910.00        | £28,000.00      |
| 2.0 TFSI quattro | 211PS | 6-speed manual | 188                  | £23,616.67 | £28,340.00        | £29,430.00      |
| 2.0 TDI quattro  | 143PS | 6-speed manual | 162                  | £22,679.17 | £27,215.00        | £28,025.00      |
| 2.0 TDI quattro  | 170PS | 6-speed manual | 199                  | £23,616.67 | £28,340.00        | £29,150.00      |

## Audi Q5 SE

| Engines          | Power | Transmissions    | CO <sub>2</sub> g/km | Basic RRP  | Total RRP inc VAT | Recommended OTR |
|------------------|-------|------------------|----------------------|------------|-------------------|-----------------|
| 2.0 TFSI quattro | 180PS | 6-speed manual   | 188                  | £24,383.33 | £29,260.00        | £30,350.00      |
| 2.0 TFSI quattro | 211PS | 6-speed manual   | 188                  | £25,575.00 | £30,690.00        | £31,780.00      |
| 3.2 FSI quattro  | 270PS | 7-speed S tronic | 218                  | £29,745.83 | £35,695.00        | £36,920.00      |
| 2.0 TDI quattro  | 143PS | 6-speed manual   | 162                  | £24,637.50 | £29,565.00        | £30,375.00      |
| 2.0 TDI quattro  | 170PS | 6-speed manual   | 184                  | £25,575.00 | £30,690.00        | £31,500.00      |
| 3.0 TDI quattro  | 240PS | 7-speed S tronic | 199                  | £30,170.83 | £36,205.00        | £37,295.00      |

## Audi Q5 S line

| Engines          | Power | Transmissions    | CO <sub>2</sub> g/km | Basic RRP  | Total RRP inc VAT | Recommended OTR |
|------------------|-------|------------------|----------------------|------------|-------------------|-----------------|
| 2.0 TFSI quattro | 180PS | 6-speed manual   | 188                  | £26,212.50 | £31,455.00        | £32,545.00      |
| 2.0 TFSI quattro | 211PS | 6-speed manual   | 188                  | £27,404.17 | £32,885.00        | £33,975.00      |
| 3.2 FSI quattro  | 270PS | 7-speed S tronic | 218                  | £31,575.00 | £37,890.00        | £39,115.00      |
| 2.0 TDI quattro  | 143PS | 6-speed manual   | 162                  | £26,466.67 | £31,760.00        | £32,570.00      |
| 2.0 TDI quattro  | 170PS | 6-speed manual   | 184                  | £27,404.17 | £32,885.00        | £33,695.00      |
| 3.0 TDI quattro  | 240PS | 7-speed S tronic | 199                  | £32,000.00 | £38,400.00        | £39,490.00      |

**Please note:** The maximum power output figures are quoted in PS (or Pferdestärke, which is the metric equivalent of brake horsepower). To convert to brake horsepower, divide the PS figure by 1.0139.

**Recommended On-The-Road (OTR) retail prices include:** delivery charge, half a tank of fuel, number plates at £590.00 (inc. VAT), Road Fund Licence (which may vary depending on model/transmission – see page 62 for details) and first registration fee at £55.00. Vehicle Excise Duty correct at time of going to print, but this may alter to reflect any change in the applicable VED rate.

RRP – Recommended Retail Price. VAT is calculated at 20% but this may alter to reflect any change in the applicable VAT rate.

## Audi Q5 S line Special Edition

| Engines          | Power | Transmissions    | CO <sub>2</sub> g/km | Basic RRP  | Total RRP inc VAT | Recommended OTR |
|------------------|-------|------------------|----------------------|------------|-------------------|-----------------|
| 2.0 TFSI quattro | 180PS | 6-speed manual   | 188                  | £27,275.00 | £32,730.00        | £33,820.00      |
| 2.0 TFSI quattro | 211PS | 6-speed manual   | 188                  | £28,466.67 | £34,160.00        | £35,250.00      |
| 3.2 FSI quattro  | 270PS | 7-speed S tronic | 218                  | £32,637.50 | £39,165.00        | £40,390.00      |
| 2.0 TDI quattro  | 143PS | 6-speed manual   | 162                  | £27,529.17 | £33,035.00        | £33,845.00      |
| 2.0 TDI quattro  | 170PS | 6-speed manual   | 184                  | £28,466.67 | £34,160.00        | £34,970.00      |
| 3.0 TDI quattro  | 240PS | 7-speed S tronic | 199                  | £33,062.50 | £39,675.00        | £40,765.00      |

## Transmissions

|                          | 7-speed S tronic |
|--------------------------|------------------|
| 2.0 TFSI 211PS           | •                |
| 3.2 FSI                  | S                |
| 2.0 TDI 170PS            | •                |
| 3.0 TDI                  | S                |
| <b>Basic RRP</b>         | <b>£1,233.33</b> |
| <b>Total RRP inc VAT</b> | <b>£1,480.00</b> |

– = Not available

• = Available

S = Standard



## Audi exclusive



## Audi exclusive

Every Audi is intrinsically exclusive. It's the breathtaking design, the exceptional engineering, the Vorsprung durch Technik. But for that special touch you can specify your new Audi Q5 with options from Audi exclusive. Whether you want a unique, custom-mixed paint colour or seats in a combination of complementary shades, Audi exclusive will enable you to drive the car you've always imagined.

Both the exclusive and standard options can be found on the following pages.



## Audi exclusive line





# Paint

You can select one of the standard colours shown opposite or, for a different look, choose from a range of optional finishes.

## Standard colours



Ibis white - T9

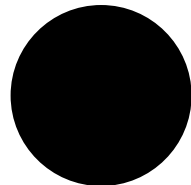

Brilliant black - A2

## Optional colours

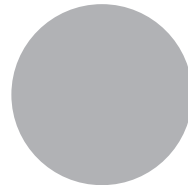

Ice silver, metallic - P5

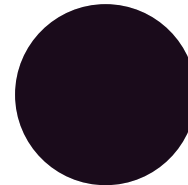

Tungsten grey, metallic - 1J

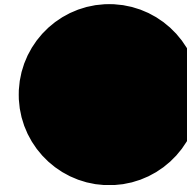

Phantom black, pearl effect - L8

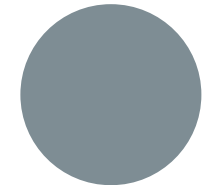

Quartz grey, metallic - Q4

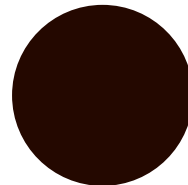

Teak brown, metallic - 4U

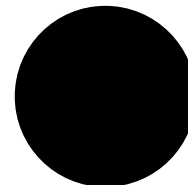

Lava grey, pearl effect - 1R

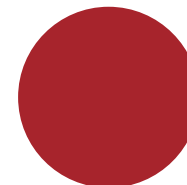

Garnet red, pearl effect - 9C

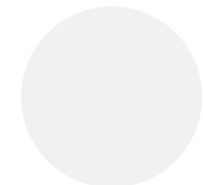

Glacier white, metallic - 2Y

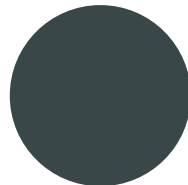

Monsoon grey, metallic - 0C

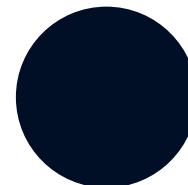

Moonlight blue, metallic - W1

All the colour swatches on this page are matched as accurately as possible to the actual paint colours used. However, due to print processes, Audi UK cannot guarantee that colours shown are 100% accurate.

Visit your local Audi Centre for a more accurate colour swatch.

Options are subject to availability and may extend delivery.

RRP - Recommended Retail Price.

VAT is calculated at 20% but this may alter to reflect any change in the applicable VAT rate.

### Optional colours

**Basic RRP**

£512.50

**Total RRP inc VAT**

£615.00

### S line colours

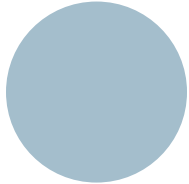

Monza silver, metallic - U7

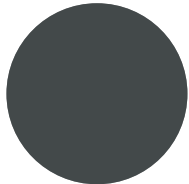

Daytona grey, pearl effect - 6Y

### S line colours

**Basic RRP**  
£512.50

**Total RRP inc VAT**  
£615.00

## Paint

### Audi exclusive

Everyone has a favourite colour. No matter what yours is, Audi exclusive provides a range of unique colours that have been designed to set your car apart. Choose from the swatches here, or specify any other paint colour in the Audi range – whether it’s Jet blue from the Audi R8 or Alpine white from the original Audi quattro®. The choice is yours.

### Customised

If you have a particular colour in mind, we’ll mix the exact metallic or pearl-effect shade you want.\*

\*Custom paint is subject to factory approval, and is available for metallic and pearl-effect water-based paints only. Three-colour process colours and two-tone schemes are not available.

\*\*Visit your local Audi Centre for colour samples.

All the colour swatches on this page are matched as accurately as possible to the actual paint colours used. However, due to print processes, Audi UK cannot guarantee that colours shown are 100% accurate.

Visit your local Audi Centre for a more accurate colour swatch.

RRP – Recommended Retail Price.

VAT is calculated at 20% but this may alter to reflect any change in the applicable VAT rate.

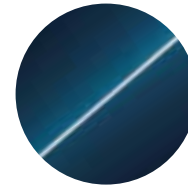

Palace blue, pearl effect

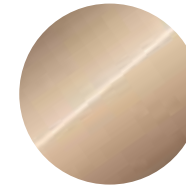

Sand beige, pearl effect

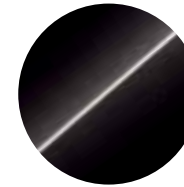

Saddle brown, pearl effect

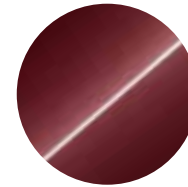

Classic red, pearl effect

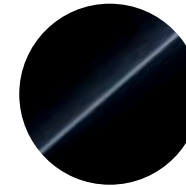

Mamba black, metallic

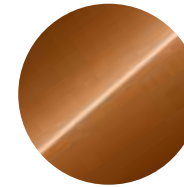

Ipanema brown, metallic



Any colour in the Audi range



100 Audi exclusive colours to choose from\*\*

### Audi exclusive

**Basic RRP**  
£1,445.83

**Total RRP inc VAT**  
£1,735.00



Customised paint

### Customised

**Basic RRP**  
£2,041.67

**Total RRP inc VAT**  
£2,450.00



# Upholstery

## Standard seats

Choose your favourite upholstery from the swatches shown opposite to give your car's interior the look and feel you want.











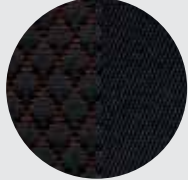

Please note: when ordering leather upholstery on standard cars, this must be combined with an upgraded inlay. When upgrading from Steppe cloth to Havana cloth, an upgraded inlay will be required at extra cost.

Options are subject to availability and may extend delivery.

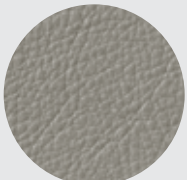
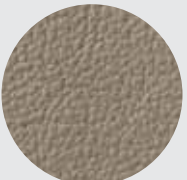
- = Not available  
 • = Available  
 S = Standard

RRP - Recommended Retail Price.

VAT is calculated at 20% but this may alter to reflect any change in the applicable VAT rate.

|                    |   |  |  |  | Standard | SE | S line | S line Special Edition | Basic RRP | Total RRP inc VAT |
|--------------------|---|--|--|--|----------|----|--------|------------------------|-----------|-------------------|
| Steppe cloth       |    |    |  |  | S        | -  | -      | -                      | No charge | No charge         |
|                    | Black/Orange - RA   | Light grey - RD  |  |  |          |    |        |                        |           |                   |
| Havana cloth       |    |    |   |  | •        | -  | -      | -                      | £304.17   | £365.00           |
|                    | Black/Cinnamon - RB   | Light grey - RD  | Cardamom beige - RG  |  |          |    |        |                        |           |                   |
|                    |   |  |  |  |          |    |        |                        |           |                   |
| Milano leather     |    |    |   |  | •        | S  | -      | -                      | £1,362.50 | £1,635.00         |
|                    | Black - CA  | Light grey - RD  | Cardamom beige - RG  |  |          |    |        |                        |           |                   |
|                    |   |  |  |  |          |    |        |                        |           |                   |
| Fine Nappa leather |   |   |  |  | •        | -  | -      | -                      | £1,704.17 | £2,045.00         |
|                    | Black - CA  | Star silver - RC/RF  | Cinnamon brown - RE  |  |          |    |        |                        |           |                   |
|                    |  |  |  |  | -        | •  | -      | -                      | £341.67   | £410.00           |
|                    | Light grey - RD   | Cardamom beige - RG  |  |  |          |    |        |                        |           |                   |

# Upholstery

## Sports seats

With electric lumbar support.







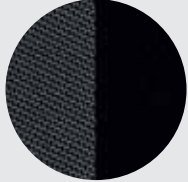
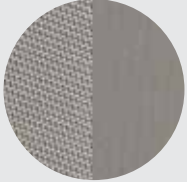

Options are subject to availability and may extend delivery.

\*When selecting Micron cloth an upgraded inlay will be required at additional cost.

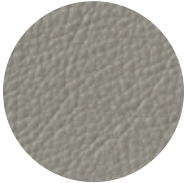
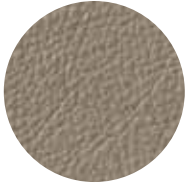
- = Not available  
 . = Available  
 S = Standard

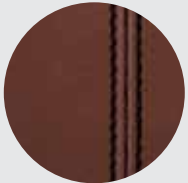
RRP - Recommended Retail Price.

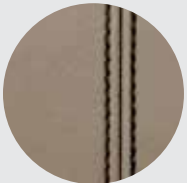
VAT is calculated at 20% but this may alter to reflect any change in the applicable VAT rate.

|                    |   |  |   |  | Standard | SE | S line | S line Special Edition | Basic RRP | Total RRP inc VAT |
|--------------------|---|--|---|--|----------|----|--------|------------------------|-----------|-------------------|
| Micron cloth*      |    |    |   |  | ●        | -  | -      | -                      | £595.83   | £715.00           |
|                    | Black - CA  | Light grey - RD  |   |  |          |    |        |                        |           |                   |
| Milano leather     |    |    |  |  | ●        | -  | -      | -                      | £1,704.17 | £2,045.00         |
|                    | Black - CA  | Light grey - RD  | Cardamom beige - RG   |  | -        | ●  | -      | -                      | £341.67   | £410.00           |
|                    |   |  |   |  |          |    |        |                        |           |                   |
| Fine Nappa leather |    |    |  |  | ●        | -  | -      | -                      | £2,041.67 | £2,450.00         |
|                    | Black/Black - CA  | Star silver/Black - CQ/CR  | Cinnamon/Black - EU   |  | -        | ●  | -      | -                      | £679.17   | £815.00           |
|                    |   |   |   |  |          |    |        |                        |           |                   |
|                    | Light grey/Black - CS   | Cardamom beige/Pimento beige - EY  |   |  |          |    |        |                        |           |                   |
| Leather/Alcantara  |  |  |   |  | ●        | -  | -      | -                      | £1,362.50 | £1,635.00         |
|                    | Black - CA  | Pale grey - RD   |   |  | -        | ●  | -      | -                      | No charge | No charge         |

# Upholstery

## S line Sports seats

|                    |  | Standard | SE | S line | S line Special Edition | Basic RRP | Total RRP inc VAT |
|--------------------|--|----------|----|--------|------------------------|-----------|-------------------|
| Milano leather     | <br>Black - QE  | -        | -  | S      | S                      | No charge | No charge         |
| Leather/Alcantara  |  Black - QE  Black with Silver stitching - QF | -        | -  | •      | •                      | No charge | No charge         |
| Fine Nappa leather | <br>Black - QE  | -        | -  | •      | •                      | £304.17   | £365.00           |

Options are subject to availability and may extend delivery.

- = Not available  
• = Available  
S = Standard

RRP - Recommended Retail Price.

VAT is calculated at 20% but this may alter to reflect any change in the applicable VAT rate.



# Colour and trim guide

## Interior trim colours

### Standard seats

To help you choose the right interior for your new Audi Q5, please use this guide, showing the carpet, dashboard and headlining colours that have been matched to your chosen upholstery.

| Order code | Upholstery     | Carpet        | Dashboard (upper/lower)     | Headlining  | Steppe cloth (N2K) | Havanna cloth (PEA) | Milano leather (PEB) | Fine Nappa leather (PEC)* |
|------------|----------------|---------------|-----------------------------|-------------|--------------------|---------------------|----------------------|---------------------------|
| RA         | Black/Orange   | Black         | Black/Black                 | Light grey  | ●                  | —                   | —                    | —                         |
| CA         | Black          | Black         | Black/Black                 | Light grey  | —                  | —                   | ●                    | ●                         |
| RC         | Star silver    | Black         | Black/Black                 | Light grey  | —                  | —                   | —                    | ●                         |
| RE         | Cinnamon       | Black         | Black/Black                 | Light grey  | —                  | —                   | —                    | ●                         |
| RD         | Light grey     | Graphite grey | Graphite grey/Graphite grey | Light grey  | ●                  | ●                   | ●                    | ●                         |
| RF         | Star silver    | Graphite grey | Graphite grey/Graphite grey | Light grey  | —                  | —                   | —                    | ●                         |
| RG         | Cardamom beige | Pimento beige | Pimento beige/Pimento beige | Linen beige | —                  | ●                   | ●                    | ●                         |
| RB         | Black/Cinnamon | Black         | Black/Black                 | Light grey  | —                  | ●                   | —                    | —                         |

### Sports seats

Options are subject to availability and may extend delivery.

— = Not available  
● = Available  
S = Standard

\*Includes Leather package (7HB) as a no cost option.

RRP – Recommended Retail Price.

VAT is calculated at 20% but this may alter to reflect any change in the applicable VAT rate.

| Order code | Upholstery                            | Carpet        | Dashboard (upper/lower)     | Headlining  | Micron cloth (PEK) | Leather/Alcantara (PED) | Milano leather (PEL) | Fine Nappa leather (PEE)* |
|------------|---------------------------------------|---------------|-----------------------------|-------------|--------------------|-------------------------|----------------------|---------------------------|
| CA         | Black                                 | Black         | Black/Black                 | Light grey  | ●                  | ●                       | ●                    | ●                         |
| RD         | Light grey                            | Graphite grey | Graphite grey/Graphite grey | Light grey  | ●                  | ●                       | ●                    | —                         |
| RG         | Cardamom beige                        | Pimento beige | Pimento beige/Pimento beige | Linen beige | —                  | —                       | ●                    | —                         |
| CQ         | Star silver with Black stitching      | Black         | Black/Black                 | Light grey  | —                  | —                       | —                    | ●                         |
| EU         | Cinnamon with Black stitching         | Black         | Black/Black                 | Light grey  | —                  | —                       | —                    | ●                         |
| CS         | Light grey with Black stitching       | Graphite grey | Graphite grey/Graphite grey | Light grey  | —                  | —                       | —                    | ●                         |
| CR         | Star silver with Black stitching      | Graphite grey | Graphite grey/Graphite grey | Light grey  | —                  | —                       | —                    | ●                         |
| EY         | Cardamom beige with Pimento stitching | Pimento beige | Pimento beige/Pimento beige | Linen beige | —                  | —                       | —                    | ●                         |

# Colour and trim guide

## Interior trim colours

### S line seats

| Order code | Upholstery                  | Carpet | Dashboard (upper/lower) | Headlining | Leather/Alcantara (N7K) | Milano leather (N1Y) | Fine Nappa leather (N2R) |
|------------|-----------------------------|--------|-------------------------|------------|-------------------------|----------------------|--------------------------|
| QE         | Black with Black stitching  | Black  | Black/Black             | Black      | •                       | •                    | •                        |
| QF         | Black with Silver stitching | Black  | Black/Black             | Black      | •                       | –                    | –                        |



Options are subject to availability and may extend delivery.

– = Not available  
 • = Available  
 S = Standard

RRP – Recommended Retail Price.

VAT is calculated at 20% but this may alter to reflect any change in the applicable VAT rate.

# Upholstery

## Audi exclusive

With Audi exclusive, you can specify your seats in Fine Nappa leather, Valcona leather or Valcona leather/Alcantara in an array of different colours shown to the right.

Select just one all-over shade for each seat, or customise each panel in two or more complementary colours from the distinctive Audi exclusive palette. You can even choose the colour of the decorative stitching – to match or contrast with your chosen upholstery – from this varied collection. Whatever combination you decide upon, we think you'll be extremely comfortable with the result.



Chestnut brown



Jet grey



Alabaster white

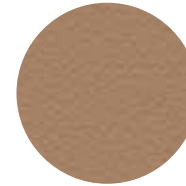

Sand beige

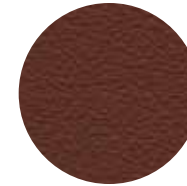

Saddle brown

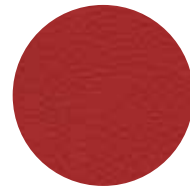

Crimson red



Magnolia white



Havanna brown

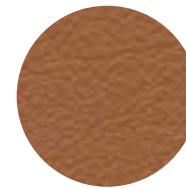

Cognac brown

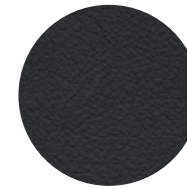

Night blue

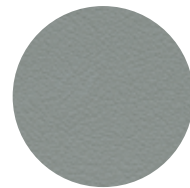

Cloudy grey

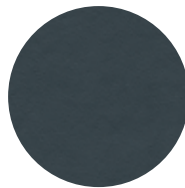

Smoky blue

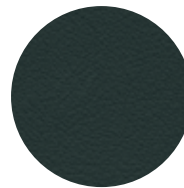

Iceland green



Powder beige



Classic red

## Also available:

**Alcantara colours:** available in all the Audi exclusive colours shown, except for Crimson red, Jet grey and Sand beige. Alcantara equivalents are Chilli red, Amethyst grey, and Sesame beige respectively.

Please consult your Audi Centre for examples of Alcantara and carpet colours.

# Upholstery

## Audi exclusive

| Order Code     |   | Standard | SE | S line | S line Special Edition | Basic RRP | Total RRP inc VAT |
|----------------|---|----------|----|--------|------------------------|-----------|-------------------|
| <b>PYA S3G</b> | <b>Audi exclusive leather package 1 in Fine Nappa leather.</b> Includes leather-covered seat upholstery and front centre armrest. Backrest covers and seat add-on parts come in the interior trim colour*   | -        | ●  | -      | -                      | £1,779.17 | £2,135.00         |
| <b>PYB S3G</b> | <b>Audi exclusive leather package 1 in Valcona leather with climate comfort seats.</b> Includes leather-covered seat upholstery and front centre armrest. Backrest covers and seat add-on parts come in the interior trim colour*   | -        | ●  | -      | -                      | £4,712.50 | £5,655.00         |
| <b>PYC S3G</b> | <b>Audi exclusive leather package 1 in Valcona leather/Alcantara.</b> Includes leather-covered seat side trims, head restraints, front centre armrest and Alcantara seat-centre sections. Backrest covers and seat add-on parts come in the interior trim colour*   | -        | ●  | -      | -                      | £2,120.83 | £2,545.00         |
|                |   | -        | -  | ●      | ●                      | £1,779.17 | £2,135.00         |
| <b>PYD S3G</b> | <b>Audi exclusive leather package 2 in Fine Nappa leather.</b> Includes all the contents of leather package 1 (PYA/S3G) plus: leather-covered seat backrest covers, door armrests and handles, and colour-coordinated seat-side trims and add-on parts  | -        | ●  | -      | -                      | £3,020.83 | £3,625.00         |
| <b>PYE S3G</b> | <b>Audi exclusive leather package 2 in Valcona leather with climate comfort seats.</b> Includes all the contents of leather package 1 (PYB/S3G) plus: leather-covered seat backrest covers, and door armrests and handles. Seat-side trims and add-on parts are colour-coordinated. Only available in conjunction with interior code CA or QE | -        | ●  | -      | -                      | £5,958.33 | £7,150.00         |
| <b>PYG S3G</b> | <b>Audi exclusive leather package 1 in Fine Nappa leather with Sports seats.</b> Includes all the contents of leather package 1 (PYA/S3G) plus: leather-covered front Sports seats  | -        | ●  | -      | -                      | £2,120.83 | £2,545.00         |
|                |   | -        | -  | ●      | ●                      | £1,779.17 | £2,135.00         |
| <b>PYJ S3G</b> | <b>Audi exclusive leather package 2 in Fine Nappa leather with Sports seats.</b> Includes all the contents of leather package 1 (PYA/S3G) plus: leather-covered Sports seats, seat backrest covers, and door armrests and handles. Seat-side trims and add-on parts are colour coordinated  | -        | ●  | -      | -                      | £3,366.67 | £4,040.00         |
|                |   | -        | -  | ●      | ●                      | £3,025.00 | £3,630.00         |

Options are subject to availability and may extend delivery.

- = Not available  
 ● = Available  
 S = Standard

\*Leather and stitching (where applicable) colours can be specified in a variety of colours from the Audi exclusive range.

RRP – Recommended Retail Price.

VAT is calculated at 20% but this may alter to reflect any change in the applicable VAT rate.



# Upholstery

## Audi exclusive

Audi exclusive is ultimately about choice – but if you'd rather leave some of the decisions in the capable hands of our designers, the expert team at quattro® GmbH have compiled Audi exclusive line, combining some of the most popular elements of the exclusive range in one, beautifully coordinated package.

Options are subject to availability and may extend delivery.

- = Not available  
 • = Available  
 S = Standard

RRP – Recommended Retail Price.

VAT is calculated at 20% but this may alter to reflect any change in the applicable VAT rate.

| Order Code |                     | Standard | SE | S line | S line Special Edition | Basic RRP | Total RRP inc VAT |
|------------|---------------------|----------|----|--------|------------------------|-----------|-------------------|
| WQK        | Audi exclusive line |          | •  |        |                        | £2,058.33 | £2,470.00         |



Magnolia white – QQ



Alabaster white – UA



Cognac brown – QX

### This package includes

- ▶ Two-colour seat upholstery in Fine Nappa leather (black seat-side sections, seat-centre section in Alabaster white, Magnolia white or Cognac brown)
  - ▶ Seat-side sections and head restraints with coloured piping (to match seat-centre section)
  - ▶ Sports seats including electric lumbar support
  - ▶ Black interior including black add-on seat parts
  - ▶ Headlining in black cloth
  - ▶ Audi exclusive door sill trims, additional stainless steel loading lip cover
  - ▶ Leather-covered cockpit on driver's side in black with coloured stitching
  - ▶ Inlays in matt-brushed aluminium or walnut natural
  - ▶ Leather-covered Sports steering wheel in 3-spoke design with coloured stitching (to match seat-centre section)
  - ▶ Gear-lever gaiter with coloured stitching (to match seat-centre section)
  - ▶ Armrest in door trims in leather with coloured stitching (to match seat-centre section)
  - ▶ Floor mats with coloured piping (to match seat-centre section)
- Can only be ordered in conjunction with rear bench seat (SKA)



# Inlays

Inlays are the all-important finishing touch that add flair and interest to your car's interior.

| Order Code |                               | Standard | SE | S line | S line Special Edition | Basic RRP | Total RRP inc VAT |
|------------|-------------------------------|----------|----|--------|------------------------|-----------|-------------------|
| 5MF        | Aluminium silver*             | ●        | S  | —      | —                      | £170.83   | £205.00           |
| 5TG        | Matt-brushed aluminium        | —        | —  | S      | S                      | No charge | No charge         |
| 5TK        | Fine grain ash, almond beige* | ●        | ●  | —      | —                      | £170.83   | £205.00           |
| 5TS        | Walnut, natural*              | ●        | ●  | —      | —                      | £170.83   | £205.00           |
| 7TL        | Fine grain ash, natural*      | ●        | ●  | —      | —                      | £170.83   | £205.00           |
| 5TL        | Piano finish, black           | —        | —  | ●      | ●                      | £254.17   | £305.00           |
| YTE S3G    | Carbon atlas                  | —        | —  | ●      | ●                      | £937.50   | £1,125.00         |

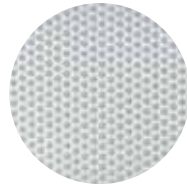

Aluminium silver\* – 5MF



Matt-brushed aluminium – 5TG



Fine grain ash, almond beige\* – 5TK



Walnut, natural\* – 5TS

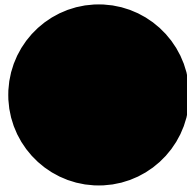

Piano finish, black – 5TL



Fine grain ash, natural\* – 7TL

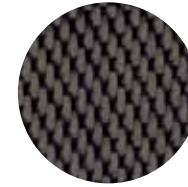

Carbon atlas – 5TU

Options are subject to availability and may extend delivery.

— = Not available  
 ● = Available  
 S = Standard

\*Must be combined with leather upholstery.

RRP – Recommended Retail Price.

VAT is calculated at 20% but this may alter to reflect any change in the applicable VAT rate.

# Inlays

## Audi exclusive

Audi exclusive has sourced a wide range of materials which you can select for your inlays, from Sepia oak to warm Saffron poplar.

| Order Code |  | Standard | SE | S line | S line Special Edition | Basic RRP | Total RRP inc VAT |
|------------|--|----------|----|--------|------------------------|-----------|-------------------|
| YTA S3G    | <b>Audi exclusive inlays</b> (cannot be combined with the inlays shown on page 36) | –        | •  | •      | •                      | £758.33   | £910.00           |



Fine grain ash, nougat



Fine grain myrtle, nutmeg



Poplar, saffron



Oak, sepia

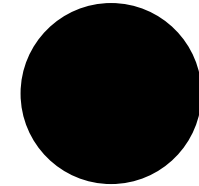

Piano finish, black

Options are subject to availability and may extend delivery.

– = Not available  
 • = Available  
 S = Standard

RRP – Recommended Retail Price.

VAT is calculated at 20% but this may alter to reflect any change in the applicable VAT rate.

## Wheels, tyres and suspension

Choose a set of specially-selected alloy wheels to subtly enhance the way your car looks and drives. And you can also specify Audi drive select, which allows you to change suspension and steering settings according to your driving style.



18" x 8J '10-spoke V'  
design alloy wheels - PRC



18" x 8J '6-spoke Parabola'  
design alloy wheels - PRS



19" x 8J '5-arm'  
design alloy wheels - PRL



19" x 8J '10-spoke Star'  
design alloy wheels - PRT



20" x 8.5J '5-spoke Star'  
design alloy wheels\* - PRD



20" x 8.5J '5-segment-spoke'  
design alloy wheels - PQ6



20" x 8.5J '5-double-spoke off-road'  
design alloy wheels\* - PQ7



20" x 8.5J '7-double-spoke'  
design alloy wheels\* - PQF



20" x 8.5J '20-spoke'  
design alloy wheels\* - PQS

\*Please note: this option includes a small extension to the wheel arches.

On S line trims the wheel arch is matt black, while on SE models it matches the colour of the contrasting bumpers.

# Wheels, tyres and suspension

| Order Code |  | Standard | SE | S line | S line Special Edition | Basic RRP | Total RRP inc VAT |
|------------|--|----------|----|--------|------------------------|-----------|-------------------|
| PRC        | 18" x 8J '10-spoke V' design alloy wheels with 235/60 R18 tyres  | ●        | S  | -      | -                      | £425.00   | £510.00           |
| PRS        | 18" x 8J '6-spoke Parabola' design alloy wheels with 235/60 R18 tyres  | ●        | -  | -      | -                      | £595.83   | £715.00           |
|            |  | -        | ●  | -      | -                      | £170.83   | £205.00           |
| PRL        | 19" x 8J '5-arm' design alloy wheels with 235/55 R19 tyres   | ●        | -  | -      | -                      | £850.00   | £1,020.00         |
|            |  | -        | ●  | -      | -                      | £425.00   | £510.00           |
| PRT        | 19" x 8J '10-spoke Star' design alloy wheels with 235/55 R19 tyres   | ●        | -  | -      | -                      | £937.50   | £1,125.00         |
|            |  | -        | ●  | -      | -                      | £512.50   | £615.00           |
| PRD        | 20" x 8.5J '5-spoke Star' design alloy wheels with 255/45 R20 tyres*<br>(not available in conjunction with off-road styling package - VJ2)   | ●        | -  | -      | -                      | £1,445.83 | £1,735.00         |
|            |  | -        | ●  | -      | -                      | £1,020.83 | £1,225.00         |
| PQ6        | 20" x 8.5J '5-segment-spoke design' with 255/45 R20 tyres  | ●        | -  | -      | -                      | £1,445.83 | £1,735.00         |
|            |  | -        | ●  | -      | -                      | £1,020.83 | £1,225.00         |
|            |  | -        | -  | ●      | -                      | £425.00   | £510.00           |
| PQ7        | 20" x 8.5J '5-double-spoke off-road' design alloy wheels with 255/45 R20 tyres*<br>(only available in conjunction with off-road styling package - VJ2, except on S line Special Edition) | -        | -  | -      | ●                      | No charge | No charge         |
|            |  | ●        | ●  | -      | S                      | £425.00   | £510.00           |
| PQF        | 20" x 8.5J '7-double-spoke' design polished alloy wheels with 255/45 R20 tyres*<br>(not available in conjunction with off-road styling package - VJ2)                                    | ●        | -  | -      | -                      | £1,445.83 | £1,735.00         |
|            |  | -        | ●  | -      | -                      | £1,020.83 | £1,225.00         |
|            |  | -        | -  | ●      | -                      | £425.00   | £510.00           |
| PQS        | 20" x 8.5J '20-spoke' design two-piece alloy wheels with 255/45 R20 tyres*<br>(not available in conjunction with off-road styling package - VJ2)   | ●        | -  | -      | -                      | £1,445.83 | £1,735.00         |
|            |  | -        | ●  | -      | -                      | £1,020.83 | £1,225.00         |
|            |  | -        | -  | ●      | -                      | £425.00   | £510.00           |

Options are subject to availability and may extend delivery.

- = Not available  
 • = Available  
 S = Standard

\*Please note: this option includes a small extension to the wheel arches.

On S line trims the wheel arch is matt black, while on SE models it matches the colour of the contrasting bumpers.

RRP - Recommended Retail Price.

VAT is calculated at 20% but this may alter to reflect any change in the applicable VAT rate.

# Wheels, tyres and suspension

| Order Code |   | Standard | SE | S line | S line Special Edition | Basic RRP | Total RRP inc VAT |
|------------|---|----------|----|--------|------------------------|-----------|-------------------|
| <b>2H1</b> | <b>Audi drive select</b> changes your car's handling and responses at the touch of a button to suit the way you want to drive. There are four modes: comfort, dynamic, auto and individual. Please note that you can only choose the 'individual' mode and customise your settings if you also have Satellite Navigation installed (must be combined with dynamic steering and/or damper control) | -        | •  | •      | •                      | £183.33   | £220.00           |
| <b>1N7</b> | <b>Dynamic steering.</b> With this new technology, driving is significantly more agile under everyday conditions, while directional stability and precision are increased at high speeds and in demanding driving situations (must be combined with Audi drive select)  | -        | •  | •      | •                      | £604.17   | £725.00           |
| <b>1BL</b> | <b>Damper control</b> – formed on the basis of lowered Sports suspension, the optional damper control system fine-tunes suspension settings according to road conditions and driver needs (must be combined with Audi drive select)   | -        | •  | •      | •                      | £566.67   | £680.00           |
| <b>1BV</b> | <b>S line Sports suspension (not lowered)</b>   | -        | -  | •      | •                      | No charge | No charge         |
| <b>3F1</b> | <b>Collapsible spare wheel</b>  | •        | •  | •      | •                      | £91.67    | £110.00           |
| <b>7K6</b> | <b>Tyre pressure monitor display</b>  | •        | •  | •      | •                      | £62.50    | £75.00            |

Options are subject to availability and may extend delivery.

- = Not available  
• = Available  
S = Standard

RRP – Recommended Retail Price.

VAT is calculated at 20% but this may alter to reflect any change in the applicable VAT rate.





# Packages

Some items work well together, which is why we've created these special packages. They provide increased convenience and value by combining several of our most popular options.

| Order Code         |  | Standard | SE | S line | S line Special Edition | Basic RRP | Total RRP inc VAT |
|--------------------|--|----------|----|--------|------------------------|-----------|-------------------|
| <b>WBI 8T1 9ZX</b> | <b>Comfort package.</b> Cruise control, mobile telephone preparation – Bluetooth interface and power operated tailgate                   | –        | ●  | ●      | –                      | £508.33   | £610.00           |
| <b>WB3 QV3</b>     | <b>Sound package.</b> Bang & Olufsen sound system and DAB digital radio  | –        | ●  | ●      | S                      | £500.00   | £600.00           |
| <b>WB4 7X4</b>     | <b>Technology package – Low.</b> Satellite Navigation system – DVD-based with Audi Music Interface and Audi parking system plus          | –        | ●  | ●      | ●                      | £1,270.83 | £1,525.00         |
| <b>WB7 7X4</b>     | <b>Technology package – High.</b> Satellite Navigation system – HDD-based with MMI 3G, Audi Music Interface and Audi parking system plus | –        | ●  | ●      | ●                      | £1,700.00 | £2,040.00         |

Options are subject to availability and may extend delivery.

- = Available
- = Not available
- S = Standard

RRP – Recommended Retail Price.

VAT is calculated at 20% but this may alter to reflect any change in the applicable VAT rate.

**Satellite Navigation system – DVD-based.** DVD-based route-planning and guidance with MMI control logic and 6.5" colour monitor, 3D map display, RDS radio, DVD player for navigation system, audio or MP3 CDs. Includes European coverage disc

**Satellite Navigation system – HDD-based with MMI 3G.** 3rd generation of MMI including 2 FM tuners, high resolution (800x400) 7" colour TFT display, DVD movie-playing function, colour Driver's Information System, 2 SD card readers and 40GB hard drive – 10GB of which can be used to store up to 4,000 songs. HDD navigation functionality includes advanced speech recognition, 3D and topographical mapping display and advanced 3D building display



Mobile telephone preparation – Bluetooth interface



Bang & Olufsen sound system



# Audio and communication

Stay in touch using our range of communication functions, and give each journey its own soundtrack with our advanced audio equipment.

Options are subject to availability and may extend delivery.

- = Not available  
 • = Available  
 S = Standard

RRP – Recommended Retail Price.

VAT is calculated at 20% but this may alter to reflect any change in the applicable VAT rate.

| Order Code |  | Standard | SE | S line | S line Special Edition | Basic RRP | Total RRP inc VAT |
|------------|--|----------|----|--------|------------------------|-----------|-------------------|
| <b>BUM</b> | <b>Audi Symphony radio.</b> AM/FM twin tuner with TP memo function. Front-loading 6-CD changer with MP3 compatibility and active front and rear speakers. Includes colour centre console screen, SD memory-card reader and AUX-IN socket. Cannot be combined with Satellite Navigation   | •        | •  | •      | •                      | £191.67   | £230.00           |
| <b>QV3</b> | <b>DAB digital radio.</b> Integrated into MMI, receives digitally-transmitted radio stations in addition to the range of analogue stations. Displays music track, artist and radio program; capable of 'DAB slideshow' where transmitted. Reception dependent on local digital network. Automatic switch from DAB to FM reception if the network signal is not strong enough | •        | •  | •      | S                      | £254.17   | £305.00           |
| <b>QV9</b> | <b>TV reception – analogue and digital.</b> TV tuner for reception of 'free-to-air' TV channels. Picture display only possible on MMI screen when vehicle is stationary, audio available at all times. Reception dependent upon local digital network availability. Only in combination with Satellite Navigation system – HDD-based   | •        | •  | •      | •                      | £725.00   | £870.00           |
| <b>QU1</b> | <b>DAB digital radio in combination with TV reception</b> – analogue and digital. Only in combination with Satellite Navigation system – HDD-based   | •        | •  | •      | –                      | £979.17   | £1,175.00         |
|            |  | –        | –  | –      | •                      | £725.00   | £870.00           |
| <b>9VK</b> | <b>Bang &amp; Olufsen sound system.</b> Designed specifically for the Audi Q5, providing 5.1 surround-sound reproduction with dynamic compensation for road noise, 10-channel amplifier and 14 high-performance loudspeakers (total output 505 Watts)  | •        | –  | –      | –                      | £641.67   | £770.00           |
|            |  | –        | •  | •      | S                      | £445.83   | £535.00           |



Audi Music Interface



Control panel for HDD Satellite Navigation and MMI High



MMI High media options menu



HDD Satellite Navigation 3D building display

# Audio and communication

| Order Code         |   | Standard | SE | S line | S line Special Edition | Basic RRP | Total RRP inc VAT |
|--------------------|---|----------|----|--------|------------------------|-----------|-------------------|
| <b>PNG</b>         | <b>Satellite Navigation system – HDD-based including MMI High.</b> 3rd generation MMI system including single CD/DVD player, 2 FM tuners, high resolution (800x400) 7" colour TFT display, 2 SD card readers and 40GB hard drive, 10GB of which can be used to store up to 4,000 songs. HDD Satellite Navigation functionality includes advanced speech recognition, 3D and topographical mapping display and advanced 3D building display – must be combined with multi-function steering wheel  | ●        | ●  | ●      | ●                      | £1,658.33 | £1,990.00         |
| <b>9ZX</b>         | <b>Mobile telephone preparation – Bluetooth interface.</b> Provides handsfree connection via Bluetooth using mobile phone aerial. Please contact your Audi Centre for phone compatibility. Only in combination with multi-function steering wheel   | ●        | ●  | ●      | S                      | £208.33   | £250.00           |
| <b>PT5</b>         | <b>Mobile telephone preparation – Low with Bluetooth and voice control.</b> Provides handsfree connection via Bluetooth using mobile phone aerial. Alternatively, it can use a cradle with charging facility for optimal reception via external aerial. Located in front centre armrest (included). Cradle available at extra cost – please contact your Audi Centre for phone compatibility. Only in combination with a multi-function steering wheel  | ●        | –  | –      | –                      | £491.67   | £590.00           |
|                    |   | –        | ●  | ●      | –                      | £379.17   | £455.00           |
|                    |   | –        | –  | –      | ●                      | £212.50   | £255.00           |
|                    |   | ●        | –  | –      | –                      | £325.00   | £390.00           |
|                    |   | –        | ●  | ●      | –                      | £212.50   | £255.00           |
|                    | In combination with Comfort package   |          |    |        |                        |           |                   |
| <b>9ZW</b>         | <b>Mobile telephone preparation – High with Bluetooth and voice control.</b> Provides handsfree connection using an external aerial for optimal reception via a Bluetooth interface. Operated via the optional MMI system and integrated telephone voice-control system. Please note that your mobile phone must have SIM-Access Profile facility for full functionality. Only in combination with Satellite Navigation system – HDD-based  | –        | ●  | ●      | –                      | £554.17   | £665.00           |
|                    |   | –        | –  | –      | ●                      | £387.50   | £465.00           |
|                    |   | –        | ●  | ●      | –                      | £387.50   | £465.00           |
|                    | In combination with Comfort package   |          |    |        |                        |           |                   |
| <b>PT4</b>         | <b>Mobile telephone preparation – High with Bluetooth privacy handset located in front centre armrest.</b> The cordless handset allows passengers to make private calls, providing remote control of the telephone functions as well as a convenient SMS text message function. The handset is charged from a docking station integrated into the front centre armrest. A SIM card can be integrated directly into the handset if the mobile phone does not have SIM-Access Profile (SAP). Only in combination with Satellite Navigation system – HDD-based   | –        | ●  | ●      | –                      | £808.33   | £970.00           |
|                    |   | –        | –  | –      | ●                      | £641.67   | £770.00           |
|                    |   | –        | ●  | ●      | –                      | £641.67   | £770.00           |
|                    | In combination with Comfort package   |          |    |        |                        |           |                   |
| <b>UF7</b>         | <b>Audi Music Interface (AMI).</b> Universal connection for use with stereo audio sources, USB and MP3 devices including Apple iPod generation 4 onwards (iPod, iPod classic, iPod mini, iPod nano, iPod photo, iPod video, iPod touch). Provides intuitive control through the audio system and multi-function steering wheel (where fitted). It also replicates the iPod display on the audio screen and DIS, including track titles. The interface provides charging function (dependent on device). Includes 2 cables to connect to iPod and USB MP3 device. Provides storage for the iPod or MP3 device in the glovebox. When AMI is ordered AUX-IN is deleted | ●        | ●  | ●      | ●                      | £212.50   | £255.00           |
| <b>7D1<br/>7A6</b> | <b>CD changer and DVD player.</b> 6-CD changer located in the glovebox and single CD/DVD slot in centre console. Only available with Satellite Navigation system – DVD or HDD-based   | ●        | ●  | ●      | ●                      | £304.17   | £365.00           |
| <b>9WM</b>         | <b>Rear Seat Entertainment.</b> Includes two detachable DVD players/monitors fitted to the back of the front seats (supplied by Audi Genuine Accessories). The backs of the front seats are fitted with mountings and power connections. The system can be used outside the car with a rechargeable battery or mains power connection, which is included in the package. Includes individual remote controls and two sets of headphones   | ●        | ●  | ●      | ●                      | £875.00   | £1,050.00         |

Options are subject to availability and may extend delivery.

– = Not available  
 ● = Available  
 S = Standard

RRP – Recommended Retail Price.

VAT is calculated at 20% but this may alter to reflect any change in the applicable VAT rate.

# Interior equipment

Specify every detail of your car's interior with this range of exclusive options.

Options are subject to availability and may extend delivery.

- = Not available  
 • = Available  
 S = Standard

\*Homelink® is a registered trademark of Johnson Controls. For more information on compatibility visit [www.homelink.com](http://www.homelink.com)

RRP – Recommended Retail Price.

VAT is calculated at 20% but this may alter to reflect any change in the applicable VAT rate.

| Order Code |  | Standard | SE | S line | S line Special Edition | Basic RRP | Total RRP inc VAT |
|------------|--|----------|----|--------|------------------------|-----------|-------------------|
| <b>4F2</b> | <b>Advanced key.</b> Access and authorisation system which automatically exchanges data between key and vehicle, allowing the driver to keep the key in their pocket or bag at all times. To unlock and open, simply lift the exterior door handle. To lock, press the button on the handle. Pressing the start/stop button integrated in the centre console starts and stops the engine. Not available in conjunction with engines with Start-Stop technology | •        | •  | •      | •                      | £425.00   | £510.00           |
| <b>8T1</b> | <b>Cruise control.</b> For holding any speed above 25mph   | •        | •  | •      | •                      | £187.50   | £225.00           |
| <b>8T4</b> | <b>Adaptive cruise control (ACC).</b> Automatic distance regulation, using radar sensors to maintain required distance by braking and accelerating. Four programs (distance 1 to distance 4) set via steering column controls of the cruise control system. Only in combination with colour DIS  | •        | •  | •      | •                      | £937.50   | £1,125.00         |
|            | In combination with Comfort package  | –        | •  | •      | –                      | £750.00   | £900.00           |
| <b>VC1</b> | <b>Garage door opener (Homelink®).</b> Programmable radio-operated remote control for compatible doors/gates. Control buttons integrated in the front roof module  | •        | •  | •      | •                      | £150.00   | £180.00           |
| <b>QQ1</b> | <b>Interior light package.</b> Includes front footwell lighting, active door reflectors, illuminated vanity mirrors, rear reading lights, entrance lights and illuminated glove compartment, vents and internal door controls  | •        | •  | •      | •                      | £137.50   | £165.00           |
| <b>3FU</b> | <b>Open sky panoramic sunroof.</b> Comprising glass roof with electric slide-and-tilt control and sunshade at front and rear   | •        | •  | •      | •                      | £937.50   | £1,125.00         |



Open sky panoramic sunroof



Open sky panoramic sunroof

# Interior equipment

| Order Code |  |                   | Standard | SE | S line | S line Special Edition | Basic RRP | Total RRP inc VAT |
|------------|--|-------------------|----------|----|--------|------------------------|-----------|-------------------|
| 9AQ        | <b>3-zone electronic climate control.</b> Includes separate air distribution and digital temperature displays for driver and front passenger   | 4-cylinder models | –        | •  | •      | •                      | £383.33   | £460.00           |
|            |  | 6-cylinder models | –        | S  | S      | S                      | No charge | No charge         |
| QE5        | <b>Storage package</b> – including nets on the back of the front seats, storage compartment under the front seats (only under passenger seat if memory function is fitted), multi-fastening point in passenger footwell, luggage spider-net for boot floor, net under rear parcel shelf and lockable glove compartment |                   | •        | •  | •      | •                      | £104.17   | £125.00           |
| WTC        | <b>Luggage package</b> – including front passenger seat – folding (Q2N), rear bench seat plus (SKA), net partition (3CX), rail system with load-securing net (3GN) and reversible luggage compartment mat (6SJ). Not available with lumbar support, S line and electric seats  |                   | •        | •  | –      | –                      | £404.17   | £485.00           |
| 3GN        | <b>Load-area fixing kit.</b> Includes telescopic bar and securing belt for dividing up luggage compartment   |                   | •        | •  | •      | •                      | £150.00   | £180.00           |
| 3CX        | <b>Removable net partition.</b> Located between rear seats and rear luggage compartment. Can be used with rear seat-back in upright position, one side folded down, or completely folded down  |                   | •        | •  | •      | •                      | £75.00    | £90.00            |
| 3X2        | <b>Ski/snowboard bag</b> – only in combination with rear bench seat plus (SKA)   |                   | •        | •  | •      | •                      | £41.67    | £50.00            |
| 6SN        | <b>Underfloor storage tray in luggage compartment.</b> Size will differ depending on trim/options  |                   | •        | •  | •      | •                      | £50.00    | £60.00            |
| 6SJ        | <b>Reversible load floor mat.</b> Luggage compartment floor mat can be reversed to provide a rubber mat which extends to protect rear bumper. Includes bumper cover  |                   | •        | •  | •      | •                      | £70.83    | £85.00            |
| 6SU        | <b>Underfloor storage tray in boot.</b> Includes reversible load mat with bumper cover. Size will differ depending on trim/options   |                   | •        | •  | •      | •                      | £120.83   | £145.00           |

Options are subject to availability and may extend delivery.

– = Not available  
• = Available  
S = Standard

RRP – Recommended Retail Price.

VAT is calculated at 20% but this may alter to reflect any change in the applicable VAT rate.

# Interior equipment

| Order Code |   | Standard | SE | S line | S line Special Edition | Basic RRP | Total RRP inc VAT |
|------------|---|----------|----|--------|------------------------|-----------|-------------------|
| 6NQ        | <b>Cloth headlining – black</b>   | ●        | ●  | S      | S                      | £187.50   | £225.00           |
| 6NN        | <b>Alcantara headlining – light grey.</b> Only in combination with interior light package   | ●        | ●  | ●      | ●                      | £850.00   | £1,020.00         |
| 6NS        | <b>Alcantara headlining – black.</b> Only in combination with interior light package  | ●        | ●  | ●      | ●                      | £850.00   | £1,020.00         |
| 7HB        | <b>Leather package – door armrests.</b> Only in combination with leather or leather/Alcantara upholstery. When combined with S line the stitching is only in black. In combination with upholsteries CQ, CS, EU, EY, CR, QQ, QX, UA the stitching is in a contrasting colour                              | ●        | ●  | ●      | ●                      | £183.33   | £220.00           |
|            | In combination with Fine Nappa leather upholstery (PEC/PEE)   | ●        | ●  | ●      | ●                      | No charge | No charge         |
| 7HC        | <b>Leather package Plus – door armrests and instrument cowling.</b> Only in combination with leather or leather/Alcantara upholstery. When combined with S line the stitching is only in black. In combination with upholsteries CQ, CS, EU, EY, CR, QQ, QX, UA the stitching is in a contrasting colour. | ●        | ●  | ●      | ●                      | £383.33   | £460.00           |
|            | In combination with Fine Nappa leather upholstery (PEC/PEE)   | ●        | ●  | ●      | ●                      | £200.00   | £240.00           |
| KT1        | <b>Climate cup holder.</b> Allows cup holder to be cooled to 3°C or heated to 58°C. Operated via two control switches (one for hot and one for cold) positioned behind the cup holder. Located between driver and front passenger   | ●        | ●  | ●      | ●                      | £83.33    | £100.00           |
| 6E3        | <b>Front centre armrest with storage compartment</b>  | ●        | S  | S      | S                      | £112.50   | £135.00           |

Options are subject to availability and may extend delivery.

– = Not available  
 ● = Available  
 S = Standard

RRP – Recommended Retail Price.

VAT is calculated at 20% but this may alter to reflect any change in the applicable VAT rate.



Climate cup holder



Leather package Plus – door armrest

# Interior equipment

Options are subject to availability and may extend delivery.

- = Not available  
 • = Available  
 S = Standard

\*The colours of the stitching and piping (where applicable) can be selected from any of the exclusive colours shown on page 32. The carpet colour can also be selected from any of the exclusive colours shown on page 32, except for Crimson red and Saddle brown.

\*\*Available in Chestnut brown, Palace blue, Saddle brown, Havanna brown, Jet grey and Crimson red.

RRP – Recommended Retail Price.

VAT is calculated at 20% but this may alter to reflect any change in the applicable VAT rate.

| Order Code |  | Standard | SE | S line | S line Special Edition | Basic RRP | Total RRP inc VAT |
|------------|--|----------|----|--------|------------------------|-----------|-------------------|
| 5XF        | <b>Retractable and extendable sun visor.</b> Helps protect the driver's eyes against sunlight coming from the side. Only in combination with interior light package. Cannot be combined with Alcantara headlinings 6NS and 6NN | •        | •  | •      | •                      | £37.50    | £45.00            |
| 3Y4        | <b>Side window blinds – manual</b>   | •        | •  | •      | •                      | £83.33    | £100.00           |
| 9Q8        | <b>Colour Driver's Information System (DIS)</b>  | •        | S  | S      | S                      | £83.33    | £100.00           |
| YSQ S3G    | <b>Audi exclusive carpets.</b> Includes 4 Audi exclusive floor mats with leather piping (cannot be combined with option YSR/S3G – Audi exclusive floor mats)*  | -        | •  | •      | •                      | £800.00   | £960.00           |
| YSR S3G    | <b>Audi exclusive floor mats with leather piping.</b> Includes 4 floor mats for front and rear (cannot be combined with option YSQ/S3G – Audi exclusive carpets)*  | -        | •  | •      | •                      | £312.50   | £375.00           |
| YSK S3G    | <b>Audi exclusive headlining in Alcantara.*</b> Only in combination with interior light package  | -        | •  | •      | •                      | £1,329.17 | £1,595.00         |
| YSO S3G    | <b>Audi exclusive leather-covered instrument cowl with contrasting stitching**</b>   | -        | •  | •      | •                      | £729.17   | £875.00           |



Colour Driver's Information System



Audi exclusive floor mats with leather piping



# Seats

Choose from a variety of different seat options so you can maintain the right driving posture at all times.

| Order Code                         |   | Standard     | SE | S line | S line Special Edition | Basic RRP  | Total RRP inc VAT  |                      |
|------------------------------------|---|--------------|----|--------|------------------------|--|--------------------|----------------------|
| <b>4A3</b>                         | <b>Heated front seats.</b> Individually controlled variable temperature adjustment  | ●            | ●  | ●      | ●                      | £233.33  | £280.00            |                      |
| <b>4A4</b>                         | <b>Heated front and rear seats.</b> Individually controlled variable temperature adjustment. Only available in conjunction with leather upholstery  | ●            | ●  | ●      | ●                      | £425.00  | £510.00            |                      |
| <b>PV1</b>                         | <b>Electrically-adjustable front seats.</b> Includes adjustment for height, forwards and backwards position, backrest angle and lumbar support  | ●            | ●  | —      | —                      | £637.50  | £765.00            |                      |
|                                    |   | Sports seats | ●  | ●      | ●                      | ●  | £441.67            | £530.00              |
| <b>PV3<br/>6XL</b>                 | <b>Electrically adjustable front seats with memory function and lumbar support.</b> Comprising electric front seats with memory function on driver's side and lumbar support. Also includes electrically adjustable, heated, folding and auto-dimming door mirrors, with memory function and auto-dimming rear-view mirror  | ●            | —  | —      | —                      | £1,091.67  | £1,310.00          |                      |
|                                    |   | Sports seats | —  | ●      | —                      | —  | £904.17            | £1,085.00            |
|                                    |   | Sports seats | —  | ●      | ●                      | ●  | £895.83<br>£708.33 | £1,075.00<br>£850.00 |
| <b>7P1</b>                         | <b>Electric lumbar support.</b> For front seats with horizontal and vertical adjustment   | ●            | ●  | S      | S                      | £195.83  | £235.00            |                      |
| <b>PS8<br/>4A3<br/>PV3<br/>6XL</b> | <b>Folding climate comfort seats.</b> Climate-controlled front seats can be heated or cooled according to the driver and front passenger requirements. Includes electrically adjustable front seats with lumbar support and memory function for driver's seat. Only in combination with electrically adjustable, heated, folding, auto-dimming door mirrors with memory function and Milano leather | —            | ●  | —      | —                      | £2,179.17  | £2,615.00          |                      |
|                                    |   |              |    |        |                        | 2.0 TFSI and 2.0 TDI models (including 9AQ – 3-zone climate control) |                    |                      |
|                                    |   | —            | ●  | —      | —                      | £1,795.83  | £2,185.00          |                      |
|                                    |   |              |    |        |                        | 3.2 FSI and 3.0 TDI models   |                    |                      |
| <b>Q2N</b>                         | <b>Folding front passenger seat.</b> Not available with lumbar support, S line or electric seats  | ●            | ●  | —      | —                      | £108.33  | £130.00            |                      |
| <b>SKA</b>                         | <b>Rear bench seat plus.</b> Allows both the 1/3 and 2/3 sections of the rear bench seat to be independently adjusted by 100mm forwards and backwards. Also includes a through-load facility with an integral centre armrest containing a cup holder  | ●            | ●  | ●      | ●                      | £145.83  | £175.00            |                      |

Options are subject to availability and may extend delivery.

— = Not available  
● = Available  
S = Standard

RRP – Recommended Retail Price.

VAT is calculated at 20% but this may alter to reflect any change in the applicable VAT rate.



Electric front seats



Rear bench seat plus

# Exterior equipment

Make sure your car looks exactly as you want it to by selecting some of the striking options from our detailed list.

| Order Code |  | Standard | SE | S line | S line Special Edition | Basic RRP | Total RRP inc VAT |
|------------|--|----------|----|--------|------------------------|-----------|-------------------|
| 8N7        | <b>High-beam assist.</b> Automatically adjusts headlights from high-beam to dipped-beam when another vehicle is approaching. Can only be ordered in conjunction with light and rain sensor package   | –        | •  | •      | •                      | £83.33    | £100.00           |
| PX1<br>8Q5 | <b>Adaptive headlights.</b> Swivelling headlights for improved illumination of a winding road. Includes Xenon Plus headlights with LED daytime-running lights, headlight washers and LED rear lamps  | •        | •  | –      | –                      | £1,041.67 | £1,250.00         |
| 4ZM        | <b>Black styling package</b> – consists of black roof rails, black window surrounds, radiator grille frame in gloss black, radiator grille in matt black, number plate and fog light surround in matt black. Cannot be combined with off-road styling package  | –        | •  | •      | •                      | £308.33   | £370.00           |
| 352        | <b>Black roof rails</b>  | –        | •  | •      | •                      | £191.67   | £230.00           |
| 227        | <b>Deletion of engine technology designation at rear</b>   | •        | •  | •      | •                      | No charge | No charge         |
| 220        | <b>Deletion of model and engine technology designation at rear</b>   | •        | •  | •      | •                      | No charge | No charge         |
| 6XE        | <b>Door mirrors</b> – electrically adjustable, folding and heated  | •        | •  | •      | •                      | £158.33   | £190.00           |
| 6XL        | <b>Door mirrors</b> – electrically adjustable, folding, heated and auto-dimming with memory function. Only available with memory seats   | •        | •  | •      | •                      | £241.67   | £290.00           |
| 4L6<br>8N6 | <b>Light and rain sensor package.</b> Includes auto-dimming rear-view mirror, automatic headlight activation, automatic windscreen wipers and coming home/leaving home function  | •        | S  | S      | S                      | £270.83   | £325.00           |
| VJ2<br>PQ2 | <b>Off-road styling package.</b> Includes front and rear lower bumper spoilers with stainless steel underbody protection in off-road design, wheel arch extensions in stone grey, front grille with vertical chrome struts and 19" 'S-arm off-road' design alloys. Cannot be combined with black styling package | •        | –  | –      | –                      | £3,233.33 | £3,880.00         |
| 4E9        | <b>Power-operated tailgate.</b> Opens by pressing button on the car key, button in the driver's door trim or soft-touch button in the handle recess on the luggage compartment lid. Including lid-closing assistance unit and programmable angle for the luggage compartment lid                                 | –        | •  | –      | –                      | £2,554.17 | £3,065.00         |
| 4KF        | <b>Power-operated tailgate.</b> Opens by pressing button on the car key, button in the driver's door trim or soft-touch button in the handle recess on the luggage compartment lid. Including lid-closing assistance unit and programmable angle for the luggage compartment lid                                 | •        | •  | •      | S                      | £320.83   | £385.00           |
| 4KF        | <b>Privacy glass.</b> Dark tinted glass from B pillar backwards  | •        | •  | •      | •                      | £316.67   | £380.00           |
| 1D4        | <b>Towing equipment</b> – manual and swivelling  | •        | •  | •      | •                      | £554.17   | £665.00           |

Options are subject to availability and may extend delivery.

– = Not available  
• = Available  
S = Standard

RRP – Recommended Retail Price.

VAT is calculated at 20% but this may alter to reflect any change in the applicable VAT rate.

# Safety and security

Intelligent technology designed to give you better all-round awareness and safety on the road.

Options are subject to availability and may extend delivery.

-- = Not available  
 • = Available  
 S = Standard

RRP – Recommended Retail Price.

VAT is calculated at 20% but this may alter to reflect any change in the applicable VAT rate.

| Order Code |  | Standard | SE | S line | S line Special Edition | Basic RRP | Total RRP inc VAT |
|------------|--|----------|----|--------|------------------------|-----------|-------------------|
| 7X1        | <b>Acoustic parking system</b> (rear only). Aids parking by acoustically indicating distances to obstacles   | •        | S  | S      | S                      | £283.33   | £340.00           |
| 7X4        | <b>Audi parking system plus.</b> Aids parking by acoustically and visually indicating distances to obstacles   | •        | –  | –      | –                      | £554.17   | £665.00           |
|            |  | –        | •  | •      | •                      | £270.83   | £325.00           |
| 7X8        | <b>Audi parking system advanced.</b> Aids parking by acoustically and visually indicating distances to obstacles with guiding lines. Measured by sensors and reversing camera. Only in combination with Satellite Navigation system – HDD-based  | •        | –  | –      | –                      | £850.00   | £1,020.00         |
|            |  | –        | •  | •      | •                      | £566.67   | £680.00           |
|            |  | –        | •  | •      | •                      | £295.83   | £355.00           |
|            | In combination with technology package   | –        | •  | •      | •                      | £295.83   | £355.00           |
| UH2        | <b>Audi hill-hold assist.</b> Uses either the ESP system or electromechanical parking brake to hold the vehicle stationary (not available on engines with Start-Stop technology)   | •        | •  | •      | •                      | £54.17    | £65.00            |
| PU1        | <b>Audi lane assist.</b> Uses a discreet camera mounted at the top of the windscreen to monitor the road ahead. The driver is warned via a vibration of the steering wheel if the vehicle is about to exit the lane unintentionally. Includes acoustic windscreen. Only in combination with a 4-spoke multi-function steering wheel and light and rain sensor package. S line badging and stitching are not available. Cannot be combined with Start-Stop function | •        | •  | •      | •                      | £383.33   | £460.00           |
| 7Y1        | <b>Audi side assist.</b> Aids the driver when changing lane. Audi side assist monitors the area behind your car using radar sensors located discreetly in the rear bumper. It then informs the driver with a visual warning signal in the door mirror if there is a vehicle in their blind spot or approaching quickly from behind. The system is activated using a button in the driver's door. Only in combination with light and rain sensor package            | •        | •  | •      | •                      | £383.33   | £460.00           |

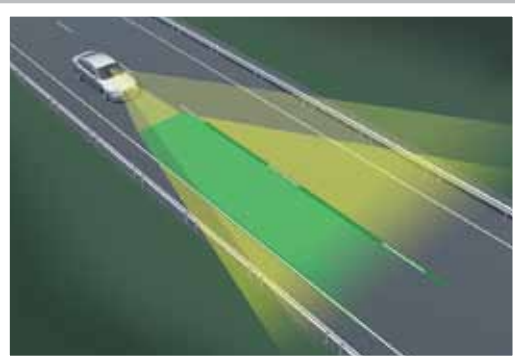

Audi lane assist



Audi lane assist – steering wheel vibration



Audi parking system advanced

# Safety and security

| Order Code |   | Standard | SE | S line | S line Special Edition | Basic RRP | Total RRP inc VAT |
|------------|---|----------|----|--------|------------------------|-----------|-------------------|
| PU2        | <b>Audi side assist and lane assist.</b> Only in combination with light and rain sensor package | ●        | ●  | ●      | ●                      | £766.67   | £920.00           |
| 8X1        | <b>Headlight washers</b>  | ●        | ●  | S      | S                      | £191.67   | £230.00           |
| 4X4        | <b>Rear side airbags.</b> Situated in side of rear seats  | ●        | ●  | ●      | ●                      | £212.50   | £255.00           |

Options are subject to availability and may extend delivery.

- = Not available  
 • = Available  
 S = Standard

RRP – Recommended Retail Price.

VAT is calculated at 20% but this may alter to reflect any change in the applicable VAT rate.



# Steering wheels

You can choose from a selection of advanced leather multi-function steering wheels, allowing you to control your audio system at the touch of a button.

Options are subject to availability and may extend delivery.

- = Not available  
 . = Available  
 S = Standard

\*The colours of the leather and stitching (where applicable) can be selected from any of the exclusive colours shown on page 32.

RRP – Recommended Retail Price.

VAT is calculated at 20% but this may alter to reflect any change in the applicable VAT rate.

| Order Code |  | Standard | SE | S line | S line Special Edition | Basic RRP | Total RRP inc VAT |
|------------|--|----------|----|--------|------------------------|-----------|-------------------|
| 1XW        | <b>3-spoke multi-function steering wheel.</b> Manual models only   | ●        | -  | -      | -                      | £341.67   | £410.00           |
|            |  | -        | ●  | -      | -                      | £87.50    | £105.00           |
|            |  | -        | -  | S      | S                      | No charge | No charge         |
| 1XX        | <b>3-spoke multi-function steering wheel with gear-shift paddles.</b> S tronic® models only  | ●        | -  | -      | -                      | £466.67   | £560.00           |
|            |  | -        | ●  | S      | S                      | £212.50   | £255.00           |
| 2ZQ        | <b>4-spoke multi-function steering wheel.</b> Manual models only. Only available in combination with Audi lane assist                            | ●        | -  | -      | -                      | £254.17   | £305.00           |
|            |  | -        | S  | ●      | ●                      | No charge | No charge         |
| 2ZS        | <b>4-spoke multi-function steering wheel with gear-shift paddles.</b> S tronic® models only. Only available in combination with Audi lane assist | ●        | -  | -      | -                      | £383.33   | £460.00           |
|            |  | -        | ●  | -      | -                      | £116.67   | £140.00           |
|            |  | -        | -  | ●      | ●                      | No charge | No charge         |
| 6Q6        | <b>Audi aluminium gear knob (manual models only)</b>   | ●        | ●  | ●      | ●                      | £104.17   | £125.00           |
| YRH S3G    | <b>Audi exclusive leather-covered steering wheel*</b>  | -        | ●  | ●      | ●                      | £400.00   | £480.00           |
| YRB S3G    | <b>Audi exclusive controls package.</b> Includes leather-covered steering wheel and gear-shift gaiter*   | -        | ●  | ●      | ●                      | £579.17   | £695.00           |



## Service Plan

Choosing an Audi Service Plan provides an easy way to cover all your car's scheduled servicing with a convenient monthly payment plan. It can take care of everything from fluid and filter changes to your full service, ensuring you retain a full Audi service history. There are no servicing bills to plan for and you'll continue to benefit from today's prices for the length of your agreement.

| Order Code |  | Standard | SE | S line | S line Special Edition | Basic RRP | Total RRP inc VAT |
|------------|--|----------|----|--------|------------------------|-----------|-------------------|
| -          | <b>3-Service Plan.</b> Comprehensive package covering servicing costs for 3 services or 30,000 miles (whichever occurs sooner). Visit <a href="http://audi.co.uk/serviceplans">audi.co.uk/serviceplans</a> for full details including terms and conditions | ●        | ●  | ●      | ●                      | £29.17    | £35.00            |
| -          | <b>5-Service Plan.</b> Comprehensive package covering servicing costs for 5 services or 50,000 miles (whichever occurs sooner). Visit <a href="http://audi.co.uk/serviceplans">audi.co.uk/serviceplans</a> for full details including terms and conditions | ●        | ●  | ●      | ●                      | £37.50    | £45.00            |

## Warranty

Options are subject to availability and may extend delivery.

- = Not available  
 ● = Available  
 S = Standard

\*Prices are based on the Audi Fixed Inspection Service Schedule and 10,000 miles per annum or less. For more information on the Service Schedule, please see page 62.

\*\*Only available when ordering your new Audi Q5. Please speak to your Audi Centre for full details.

RRP – Recommended Retail Price.

VAT is calculated at 20% but this may alter to reflect any change in the applicable VAT rate.

| Order Code |   | Standard | SE | S line | S line Special Edition | Basic RRP | Total RRP inc VAT |
|------------|---|----------|----|--------|------------------------|-----------|-------------------|
| -          | <b>Audi Warranty,</b> covering you for unlimited mileage in the first 2 years of ownership, and up to 60,000 miles in the third year. Transferable between owners**   | S        | S  | S      | S                      | No charge | No charge         |
| EA6        | <b>Audi Warranty,</b> covering you for up to 4 years or 75,000 miles, whichever comes soonest. Cover includes a 2-year unlimited mileage warranty, and up to 75,000 miles in the third and fourth years. Transferable between owners**        | ●        | ●  | ●      | ●                      | £445.83   | £535.00           |
| EA9        | <b>Audi Warranty,</b> covering you for up to 5 years or 90,000 miles, whichever comes soonest. Cover includes a 2-year unlimited mileage warranty, and up to 90,000 miles in the third, fourth and fifth years. Transferable between owners** | ●        | ●  | ●      | ●                      | £1,045.83 | £1,255.00         |

# Off-road capabilities of the Audi Q5

The Audi Q5 excels both on the road and off it, thanks to its impressive all-terrain abilities. And these attributes are reinforced by special technologies, such as hill descent assist, ABS with automatic off-road detection and an Electronic Stability Programme that includes an off-road mode.

## Hill descent assist

Available as standard in the Audi Q5, hill descent assist automatically maintains the speed set by the driver on steep descents and on any surface (up to 19mph). This makes negotiating descents far more straightforward and substantially enhances stability. Hill descent assist is activated and deactivated using a separate button.

## ESP off-road mode

The Electronic Stability Programme in the Audi Q5 features a special off-road mode which can be controlled by a switch. This reprograms the ESP system, traction control and anti-lock braking system to adapt them to the driving conditions encountered in off-road terrain, such as sand, gravel or mud. This leads to good traction in all conditions, a more exciting drive and great handling even on unpredictable surfaces.

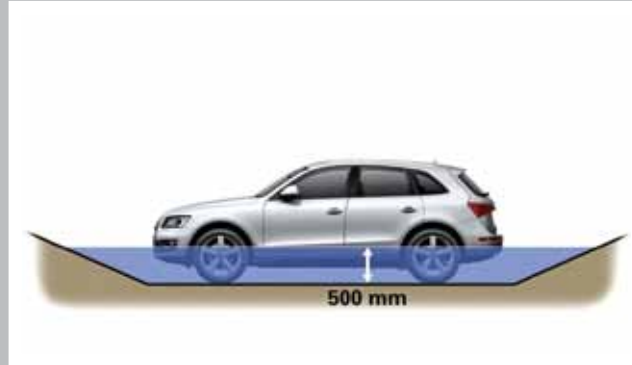

Wading



Ground clearance



Maximum gradient



Slope angle



Ramp angle

# Merchandise

From the enthusiasts' motorsport collection to the sophisticated Audi collection, there's a wide variety of adults' and children's clothing, lifestyle accessories and collectables, all of which bear the Audi name.

Please speak to a member of our team at your local Audi Centre to see the full Audi collection and to place an order. A selection of Audi merchandise is also available to buy from [audi.co.uk/merchandise](http://audi.co.uk/merchandise).



Audi kids



Bags and leather goods



Clothing



Motorsports



Sport and travel



Model cars



# Accessories

Choosing an Audi isn't just a matter of deciding on the model you want; it's about creating a car that suits your needs perfectly. That's why we've developed a whole range of accessories to enhance your Audi Q5, enabling you to customise it down to the last detail. Like your Audi, all these accessories are developed to the highest possible standards. And they're all available exclusively from Audi.

To find out more, just visit [audi.co.uk/accessories](http://audi.co.uk/accessories) or contact your local Audi Centre.

## Warranty

All the accessories available on the Audi Q5 are covered by a three-year warranty\* if they are ordered and included in the purchase price of the car at date of delivery. Any accessories ordered and installed after delivery include a two-year warranty.\*



Sport and design



Transport and touring



Entertainment and communication



Comfort and protection



Family



Safety and security

\*Excluding Road Angel products.  
Audi Accessories warranty terms and conditions can be found at [audi.co.uk](http://audi.co.uk)

# Audi Q5 Petrol technical data

| Engine   | 2.0 TFSI quattro® | 2.0 TFSI quattro® | 2.0 TFSI quattro® | 3.2 FSI quattro®  |
|--|-------------------|-------------------|-------------------|-------------------|
| Transmission   | 6-speed manual    | 6-speed manual    | 7-speed S tronic® | 7-speed S tronic® |
| Cylinder   | 4-cylinder        | 4-cylinder        | 4-cylinder        | 6-cylinder        |
| Displacement, cubic cm (valves per cylinder)             | 1984 (4)          | 1984 (4)          | 1984 (4)          | 3197 (4)          |
| Max. power <sup>1</sup> , PS at rpm                      | 180/4000-6000     | 211/6000          | 211/6000          | 270/6500          |
| Max. torque, Nm at rpm                                   | 320/1500-3900     | 350/1500-4200     | 350/1500-4200     | 330/3000-5000     |
| 0-62mph acceleration, seconds                            | 8.5               | 7.6               | 7.2               | 6.9               |
| Top speed, mph   | 130               | 138               | 137               | 145               |
| CO <sub>2</sub> emissions <sup>2</sup> , g/km            | 188               | 188               | 199               | 218               |
| Benefit in kind (BIK)%                                   | 27%               | 27%               | 29%               | 33%               |
| Fuel consumption, mpg (l/100km) Urban                    | 27.4 (10.3)       | 27.4 (10.3)       | 26.9 (10.5)       | 23.0 (12.3)       |
| Fuel consumption, mpg (l/100km) Extra Urban              | 41.5 (6.8)        | 41.5 (6.8)        | 37.7 (7.5)        | 37.2 (7.6)        |
| Fuel consumption, mpg (l/100km) Combined                 | 34.9 (8.1)        | 34.9 (8.1)        | 32.8 (8.6)        | 30.4 (9.3)        |
| ABI insurance group 1-50*                                | 28 E              | 28 E              | 28 E              | 32 E              |
| Unladen weight <sup>3</sup> , kg                         | 1720              | 1720              | 1755              | 1805              |
| Gross weight limit, kg                                   | 2330              | 2330              | 2365              | 2415              |
| Roof load limit/nose weight, kg                          | 100/80            | 100/80            | 100/80            | 100/80            |
| Max trailer load <sup>4</sup> unbraked, kg               | 750               | 750               | 750               | 750               |
| Max trailer load <sup>4</sup> with 12% gradient, kg      | 2000              | 2000              | 2000              | 2000              |
| Max trailer load <sup>4</sup> with 8% gradient, kg       | 2200              | 2400              | 2400              | 2400              |
| Luggage compartment capacity, rear seats upright, litres | 540               | 540               | 540               | 540               |
| Luggage compartment capacity, rear seats folded, litres  | 1560              | 1560              | 1560              | 1560              |
| Fuel tank capacity approx, litres                        | 75                | 75                | 75                | 75                |

\*Highest insurance group rating shown. Group may be lower dependent on trim level. Please visit [www.thatcham.org/abigroupratings](http://www.thatcham.org/abigroupratings) for details.

<sup>1</sup>The given value was obtained in accordance with the specified measurement procedure (the respective current version of the Directive 80/1269/EEC).

<sup>2</sup>The given values were calculated in accordance with the specified measurement procedure (the respective current version of Directive 80/1268/EEC). This information does not relate to a single vehicle and does not comprise part of the offer but is merely intended for the purpose of comparison between the different vehicle types.

<sup>3</sup>Vehicle's unladen weight without driver (calculated in accordance with the current version of Directive 80/1268/EEC). The fitting of additional equipment may increase the vehicle's unladen weight and drag coefficient, whereupon the potential carrying capacity and top speed will be correspondingly reduced.

<sup>4</sup>The engine's power output always goes down with increasing altitude. At 1,000m above sea level, and for every additional 1,000m, deduct 10% from the weight of the outfit (trailer load limit + gross weight of the towing vehicle).

# Audi Q5 Diesel technical data

| Engine   | 2.0 TDI quattro®* | 2.0 TDI quattro®* | 2.0 TDI quattro®* | 3.0 TDI quattro®* |
|--|-------------------|-------------------|-------------------|-------------------|
| Transmission   | 6-speed manual    | 6-speed manual    | 7-speed S tronic® | 7-speed S tronic® |
| Cylinder   | 4-cylinder        | 4-cylinder        | 4-cylinder        | 6-cylinder        |
| Displacement, cubic cm (valves per cylinder)             | 1968 (4)          | 1968 (4)          | 1968 (4)          | 2967 (4)          |
| Max. power <sup>1</sup> , PS at rpm                      | 143/4200          | 170/4200          | 170/4200          | 240/4400          |
| Max. torque, Nm at rpm                                   | 320/1750-2500     | 350/1750-2500     | 350/1750-2500     | 500/1500-3000     |
| 0-62mph acceleration, seconds                            | 11.4              | 9.9               | 9.9               | 6.5               |
| Top speed, mph   | 118               | 126               | 124               | 139               |
| CO <sub>2</sub> emissions <sup>2</sup> , g/km            | 162               | 163               | 184               | 199               |
| Benefit in kind (BIK)%                                   | 25%               | 25%               | 29%               | 32%               |
| Fuel consumption, mpg (l/100km) Urban                    | 39.2 (7.2)        | 38.7 (7.3)        | 32.1 (8.8)        | 30.7 (9.2)        |
| Fuel consumption, mpg (l/100km) Extra Urban              | 50.4 (5.6)        | 50.4 (5.6)        | 47.9 (5.9)        | 42.8 (6.6)        |
| Fuel consumption, mpg (l/100km) Combined                 | 45.6 (6.2)        | 45.6 (6.2)        | 40.4 (7.0)        | 37.6 (7.5)        |
| ABI insurance group 1-50**                               | 22 E              | 22 E              | 22 E              | 31 E              |
| Unladen weight <sup>3</sup> , kg                         | 1755              | 1755              | 1820              | 1880              |
| Gross weight limit, kg                                   | 2365              | 2365              | 2430              | 2490              |
| Roof load limit/nose weight, kg                          | 100/80            | 100/80            | 100/80            | 100/80            |
| Max trailer load <sup>4</sup> unbraked, kg               | 750               | 750               | 750               | 750               |
| Max trailer load <sup>4</sup> with 12% gradient, kg      | 1800              | 1800              | 2000              | 2000              |
| Max trailer load <sup>4</sup> with 8% gradient, kg       | 2000              | 2200              | 2400              | 2400              |
| Luggage compartment capacity, rear seats upright, litres | 540               | 540               | 540               | 540               |
| Luggage compartment capacity, rear seats folded, litres  | 1560              | 1560              | 1560              | 1560              |
| Fuel tank capacity approx, litres                        | 75                | 75                | 75                | 75                |

\*With Diesel Particulate Filter

\*\*Highest insurance group rating shown. Group may be lower dependent on trim level. Please visit [www.thatcham.org/abigroupratings](http://www.thatcham.org/abigroupratings) for details.

<sup>1</sup>The given value was obtained in accordance with the specified measurement procedure (the respective current version of the Directive 80/1269/EEC).

<sup>2</sup>The given values were calculated in accordance with the specified measurement procedure (the respective current version of Directive 80/1268/EEC). This information does not relate to a single vehicle and does not comprise part of the offer but is merely intended for the purpose of comparison between the different vehicle types.

<sup>3</sup>Vehicle's unladen weight without driver (calculated in accordance with the current version of Directive 80/1268/EEC). The fitting of additional equipment may increase the vehicle's unladen weight and drag coefficient, whereupon the potential carrying capacity and top speed will be correspondingly reduced.

<sup>4</sup>The engine's power output always goes down with increasing altitude. At 1,000m above sea level, and for every additional 1,000m, deduct 10% from the weight of the outfit (trailer load limit + gross weight of the towing vehicle).

# Audi Q5 dimensions

The technical drawings opposite show the exact dimensions of the Audi Q5, so you can check everything – from whether the car will fit in your garage to whether your luggage will fit in the boot.

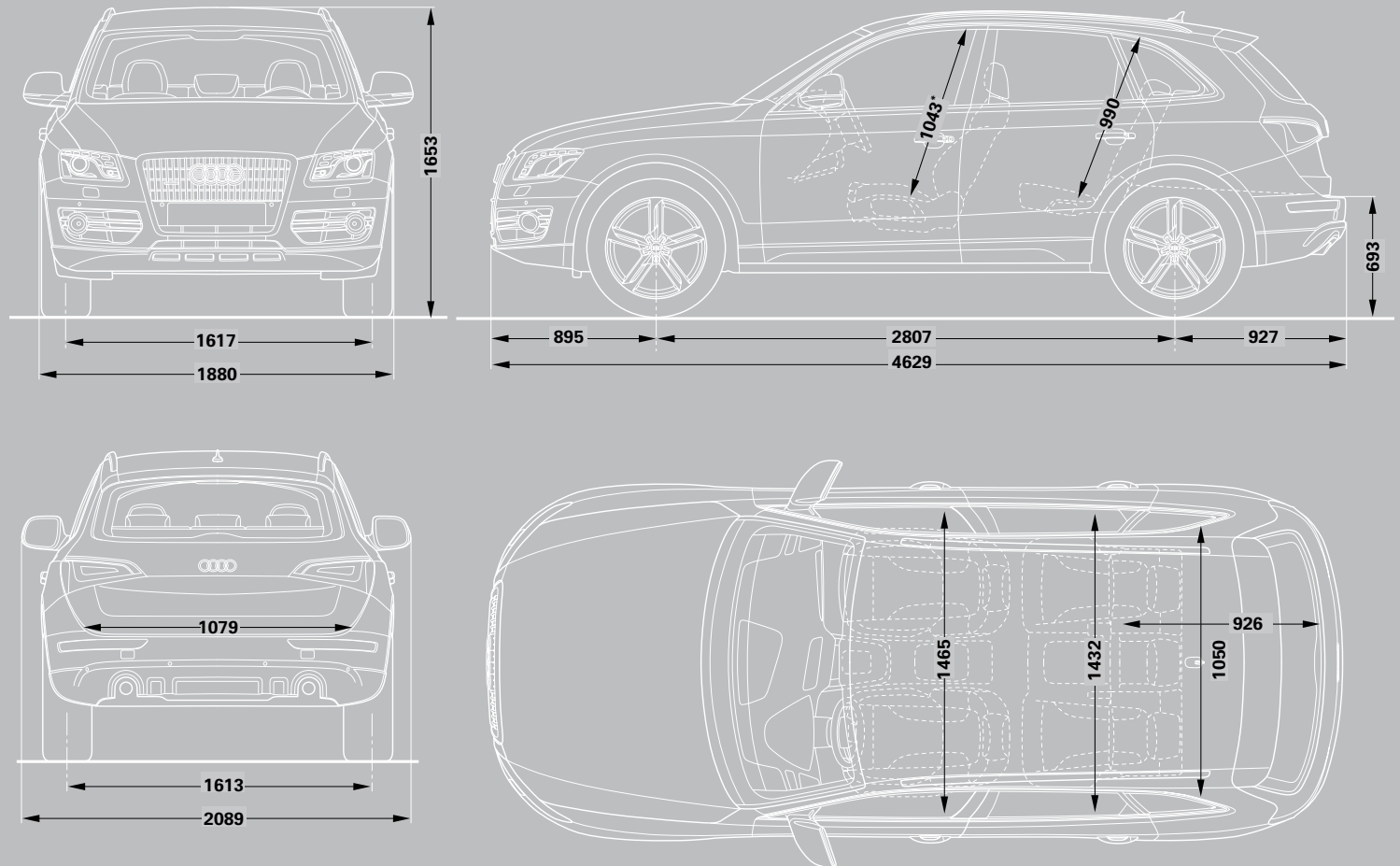

Dimensions were measured with vehicle at unladen weight.

Turning circle approx 11.7m.

Dimensions in millimetres.

\*Maximum headroom.

# Additional information

## CO<sub>2</sub> data and information

### CO<sub>2</sub> emissions-based Vehicle Excise Duty

Vehicle Excise Duty (Road Fund Licence) is based upon the amount of Carbon Dioxide (CO<sub>2</sub>) a vehicle emits, measured in grams per kilometre (g/km). First year VED rates apply to the first year of ownership. Annual VED rates apply thereafter. The DVLA has created thirteen categories:

| Petrol and Diesel engines | First year | Annual rate (second year onwards) |
|---------------------------|------------|-----------------------------------|
| A – up to 100g/km         | £0.00      | £0.00                             |
| B – 101 to 110g/km        | £0.00      | £20.00                            |
| C – 111 to 120g/km        | £0.00      | £30.00                            |
| D – 121 to 130g/km        | £0.00      | £95.00                            |
| E – 131 to 140g/km        | £115.00    | £115.00                           |
| F – 141 to 150g/km        | £130.00    | £130.00                           |
| G – 151 to 165g/km        | £165.00    | £165.00                           |
| H – 166 to 175g/km        | £265.00    | £190.00                           |
| I – 176 to 185g/km        | £315.00    | £210.00                           |
| J – 186 to 200g/km        | £445.00    | £245.00                           |
| K – 201 to 225g/km        | £580.00    | £260.00                           |
| L – 226 to 255g/km        | £790.00    | £445.00                           |
| M – over 255g/km          | £1,000.00  | £460.00                           |

Vehicle Excise Duty (VED) rates correct at time of going to print, but these may alter to reflect any change in the applicable VED rate

### Servicing tailored to your needs

Regular servicing is key to safeguarding your Audi's performance and a full Audi service history could help you preserve the future re-sale value. To make servicing easy, the Audi Service Schedules have been designed to work with your individual driving style and vehicle.

There are two schedules available and your Audi Centre will advise which schedule is most suited to your needs. The conventional fixed Audi Inspection Service schedule has fixed intervals for the Oil-change and Inspection Service that are based on time and distance, whichever comes first.

With the Audi LongLife Service schedule, sensors take account of driving style and conditions in which the vehicle is used to indicate when the Oil-change Service is required. Oil-change Service intervals are therefore variable and are conveniently indicated via the on-board service interval display.

| Fixed Inspection Service Schedule |   | Variable LongLife Service Schedule |  |
|-----------------------------------|---|------------------------------------|--|
|                                   | <b>Vehicle usage:</b>   |                                    | <b>Vehicle usage:</b>  |
| Mileage                           | Less than 10,000 miles per annum  | Mileage                            | More than 10,000 miles per annum   |
| Type of journey                   | Mainly city/town centre driving. Short journeys   | Type of journey                    | Motorway and main road driving. Mainly longer distance journeys. Constant speeds                             |
| Conditions                        | Frequent cold starts. High engine loading – e.g. frequent hill climbs, vehicle fully loaded, towing                           | Conditions                         | Normal engine loading – e.g. with little or no towing, with little or no hill climbs. Normal vehicle loading |
| Driving style                     | Uneconomical – e.g. heavy acceleration, heavy braking, constant changes in speed, constant use of high revs, 'sporty' driving | Driving style                      | Moderate acceleration, moderate braking, engine revs mainly below 3,000                                      |
|                                   | <b>Service Intervals:</b>   |                                    | <b>Service Intervals:</b>  |
| Oil-change Service                | Fixed to every 9,000* miles/1 year  | Oil-change Service                 | Variable to a maximum of every 19,000* miles/2 years   |
| Inspection Service                | Fixed to every 19,000* miles/2 years  | Inspection Service                 | Fixed to every 19,000* miles/2 years   |

\*As indicated by the service interval display. Mileages are approximate as the Service Indicator system uses kilometres as its distance measurement.

# Additional information

## Welcome to Audi

By placing an order for your Audi, you're choosing to get behind the wheel of one of the most sophisticated cars on the road. And because we believe the service we offer should be just as advanced, we wanted to let you know exactly what you can expect from us, now and in the future.

We've agreed a set of standards with all our Centres, which governs the way we do business with you. It outlines the kind of service we promise to deliver for every customer, right down to filling each new Audi we sell with half a tank of fuel.

So whether you're interested in the date your car will arrive in the UK or the way we'll dispose of non-biodegradable materials after we service your Audi, you can have total confidence in us.

## Audi Promise

### Audi Centres

We guarantee that all of our Centres will be open as follows:

Sales: Monday to Friday 9am–6pm  
Saturday 9am–5pm

Service: Monday to Friday 8am–6pm  
Saturday 8.30am–1pm

Sunday opening is at local discretion.

### New car delivery

Once we've confirmed a delivery date for your car, we'll keep you informed of progress. Subject to reasonable notice, we'll then deliver it to a place of your choice, whether that's your home or place of work. In the unlikely event of a delay, we'll provide a courtesy car to minimise inconvenience and keep you mobile.

### The experts in Vorsprung durch Technik

Would you entrust your Audi to anyone who hasn't been regularly trained to Audi standards? Our network of Audi Approved Master Technicians have undergone an impressive 100,000 hours of training over a 10-year programme to ensure they have the latest technical expertise for maintaining and servicing your Audi. All of our Service Advisors undergo a specialist induction and training to ensure they are Audi professionals and able to talk to you about any issues you may have with your Audi vehicle. What's more, we have so much expertise and experience in looking after Audi vehicles that we are able to make a note of your mileage and the state of your vehicle when we see it and predict when certain key events may occur. As part of our commitment to you, we will notify you in plenty of time so you can make an appointment with us.

### Your convenience comes first

At Audi you can choose from a range of convenient services that suit your needs. Why not book a 'service while you wait' appointment\* and enjoy our complimentary refreshments while your car is with us? Or, if you need to be mobile, take advantage of one of our courtesy cars which we can even collect and deliver to you.\* We guarantee we can service your Audi within 5 days without a courtesy car, or within 10 days if you need transport. We will also ensure your car is returned to you with a full valet.

### Audi Genuine Parts

Would you put a part into your Audi that wasn't the same quality as the factory fitted original? You can rest assured that only Audi Genuine Parts will be used on your vehicle. What's more, Audi parts and labour come with a 2-year guarantee.\*\* We stock a wide variety of parts, so we are well covered. However, if we don't have a part in stock at our Centre we have the back-up of parts at other Audi Centres, at our national warehouse and our factory and can usually source the relevant part very quickly.

### We don't like surprises either

We believe strongly in transparency and there will be no hidden costs. For added peace of mind, we will give you a quotation over the phone for the work you have requested and email you the price confirmation. We'll consult you if any additional work on your car is needed when it is with us. We won't carry out any extra work without asking your permission first.

### The Audi Stamp

Regular servicing is key to safeguarding your Audi's performance and a full Audi service history could help you preserve the future re-sale value of your car. Only the Audi Stamp will prove your approved Audi service history.

### Getting better every time

We continually gather feedback from our Audi Trained Technicians, as well as our customers, to ensure our vehicles are running as they should. Whenever we see an Audi for a service, we connect it directly to our headquarters in Ingolstadt which enables us to check your car's software and make sure it's as up-to-date as possible. If the factory has released a software upgrade for your model, it can be applied immediately – improving anything from your car's efficiency to the precision of its parking system.

### Environmental commitment

We promise to dispose of all non-biodegradable materials from your vehicle in a responsible manner.

\*Subject to availability.

\*\*Excludes wear and tear.

# Pricing information

## Pricing

Prices and specifications given are correct at the time of printing. Always check details with your Audi Centre, as Audi policies are continually developing. We reserve the right to change prices or specifications at any time.

All prices are subject to VAT, currently charged at 20% but this may alter to reflect any change in the applicable VAT rate.

Delivery charges and number plates are not included in the vehicle price.

|                 |         |
|-----------------|---------|
| Delivery charge | £471.66 |
| Number plate    | £20.00  |
| VAT             | £98.34  |
| Total           | £590.00 |

## Audi Roadside Assistance

Your new car comes complete with 3 years' complimentary roadside assistance and recovery across the UK provided by RAC Motoring Services. Also included is roadside assistance throughout Europe, managed by RAC Motoring Services.

For further information and terms and conditions please visit [audi.co.uk](http://audi.co.uk)

## Audi Customer Care

Every new Audi benefits from the comprehensive Audi Customer Care Package, which comprises:

- ▶ A 3-year Audi warranty, which covers you for unlimited mileage in the first 2 years of ownership, with a full mechanical and electrical warranty which covers you for up to 60,000 miles in the 3rd year

- ▶ A 3-year paint warranty
- ▶ A 12-year anti-corrosion warranty
- ▶ 3 years' UK roadside assistance and recovery

You also have the option when ordering your new car of choosing a 4-year or 5-year Audi warranty. Speak to a member of the sales team for more information.

## Audi Tax-Free Sales

If you are entitled to purchase a vehicle free of VAT, normally through Military or Diplomatic privilege, please contact your local Audi Centre for full details.

Should you have any difficulty obtaining the information you require, please call Freephone 0800 585878.

## Audi Finance

Audi Finance specialise in providing funding solutions for Audi drivers. Whether your Audi is for private or business use, there is a range of funding options to choose from.

Below is the full range of finance products.

- ▶ Solutions – a Personal Contract Plan
- ▶ Hire purchase
- ▶ Lease purchase
- ▶ Finance lease
- ▶ Contract hire

With all products, you can choose a fixed-cost maintenance plan designed to help you budget accurately.

No matter what Audi model you choose, your local Audi Centre can provide you with a personalised quote which could fit your budget and motoring needs.

Audi Finance is a trading name of Volkswagen Financial Services (UK) Limited. An offer of finance depends on certain conditions. Available to people over 18 in the UK only.

## Audi Insurance

We want you to start enjoying your new car from day one and thanks to Audi Insurance complimentary seven day cover, you can. Call free on 0800 316 7893 (lines are open Monday to Friday 8am - 9pm, and Saturday 9am - 5pm), provide a few details and a cover note will be sent to your Audi Centre. They will then tax your car and you can drive it away.

Audi Insurance is a trading name of Volkswagen Insurance Service (Great Britain) Limited, an appointed representative of Volkswagen Financial Services (UK) Limited, Brunswick Court, Yeomans Drive, Blakelands, Milton Keynes MK14 5LR. Registered in England number 2835230. Audi Insurance is sold, underwritten and administered by Allianz Insurance plc registered in England number 84638. Registered office 57 Ladymead, Guildford, Surrey GU1 1DB. Volkswagen Financial Services (UK) Limited and Allianz Insurance plc are authorised and regulated by the Financial Services Authority. Volkswagen Financial Services (UK) Limited and Allianz Insurance plc are not part of the same corporate group.

**Audi UK**

Customer Services  
Selectapost 29  
Sheffield  
S97 3FG  
0800 699888  
audi.co.uk

Specifications and prices subject  
to change without notice.

© Audi UK

Printed in the UK  
Edition 5.0 04/11  
2012 model year

Images are for illustrative purposes only.