

Vorsprung durch Technik

Audi



The Audi TT Coupé and Roadster

Pricing and Specification Guide
Valid from August 2011

Personalising your Audi TT

This guide has been designed to help you tailor and price your Audi TT quickly and logically. At the back, you will find information on CO2 emissions-based taxation and the other services offered by Audi, including Finance and Insurance. You can also configure your Audi TT online at audi.co.uk.

You might also like to consider Audi Complete: a simple way to take care of servicing and maintenance costs for your Audi in a single package. You pay a one-off or monthly fee and we'll cover all your servicing, maintenance and tyres for the next three years including your first MOT and a full 5-year warranty. It means you only have to pay for fuel, insurance and your Road Fund Licence. So you can be reassured that your car will be maintained by trained Audi Technicians, using genuine Audi parts.

Audi Complete™

The Audi TT

Efficiency	8
Engines	10
Transmissions	11
quattro®	12

Model details and prices

Standard model equipment	14
Sport model equipment	15
S line model equipment	15
Black Edition equipment	16
TTS model equipment	18
TTS Black Edition equipment	19
Model prices	20

Audi exclusive

22

Colour and upholstery

Paint and hoods	26
Upholstery	28
Colour and trim guide	32
Inlays	37

Options

Wheels, tyres and suspension	38
Packages	40
Audio and communication	42
Seats	44
Safety and security	45
Exterior equipment	45
Interior equipment	46
Audi Complete and warranty	48
Merchandise	49
Accessories	50

Technical details

Technical data	51
Dimensions	53
Additional information	57
Pricing information	59





Vorsprung durch Technik

Three words that express the very essence of Audi. Vorsprung durch Technik isn't a slogan. It's our way of seeing the world. It is the driving force behind our history of innovation that continues into the 21st century. Indeed, many technologies that Audi pioneered remain in our cars today. Some are milestones in the history of

the motorcar. From our beginnings in 1899 to the Auto Union team's Grand Prix successes in the 1930s and our more recent wins at Le Mans, we have always been at the forefront of the motor industry.

Vorsprung durch Technik makes us who we are. To see more of its influence, just read on.

The Audi TT is a landmark in design

The Audi TT is one of the most iconic cars in our range. Both the Coupé and Roadster are available with road-holding quattro® all-wheel-drive and a fuel-efficient TDI® engine – the same technologies that have given us unprecedented success in the Le Mans 24-hour race. There's also a wide choice of alloys and optional upholsteries for ultimate comfort. It all means that you can enjoy driving the Audi TT purely for pleasure.





Efficiency

At Audi, doing less is something we're trying to do more of. We're working to use less fuel, release less CO₂ and waste less energy. It's why we've incorporated a number of more efficient technologies into the Audi TT.

TDI® and FSI®

Inside the engine of the Audi TT you'll find the same advanced fuel-injection technology that's driven us to win after win at Le Mans. With TDI® and FSI®, fuel is injected directly into the engine's chambers so that combustion is timed right down to the millisecond. As a result, waste is minimised and you get the most from every last drop of fuel.

S tronic®

Driving is all about thinking ahead, which is just what the S tronic® dual-clutch transmission does. It works almost as two separate systems, one engaging the odd-numbered and the other the even-numbered gears. So when you're accelerating in second, it has third gear waiting for you. And once you make the switch, it's already thinking about fourth. With two clutches working together, you can change gears almost instantly while experiencing smooth, uninterrupted power.





Aerodynamics

When we designed the Audi TT, we gave it a smooth, flowing shape. As a result, its drag coefficient – a measure of aerodynamic resistance, which affects both fuel consumption and CO₂ emissions – remains surprisingly low.

Engines

Petrol

FSI® direct-injection technology is a unique Audi innovation that was originally developed for the Le Mans 24-hour endurance race to deliver more power and torque, as well as enhanced fuel efficiency. Precisely the right amount of fuel and air are injected into the combustion chambers, enabling the engine to 'breathe' more easily. It results in reduced heat loss and increased output, with around a 15% reduction in fuel consumption and significantly lower exhaust emissions. We've also developed TFSI® with turbocharging, which combines FSI® technology with forced induction – giving cars an extra injection of power.

Diesel

We introduced TDI® to the roads in 1989, marking a departure from the noisy, fuel-thirsty diesel engines of the past. And since then, we've continuously refined it, recently developing common-rail technology. Under this system, a series of piezo injectors use electrical charge to precisely control the amount of fuel injected into the engine. As well as reducing noise, this allows combustion to happen at a lower temperature, with less oxygen, which lowers emissions.





Transmissions

S tronic®

Driving is all about thinking ahead, which is just what the S tronic® dual-clutch transmission does. It works almost as two separate systems, one engaging the odd-numbered and the other the even-numbered gears. So when you're accelerating in second, it has third gear waiting for you. And once you make the switch, it's already thinking about fourth. With two clutches working together, you can change gears almost instantly while experiencing smooth, uninterrupted power.

Short-shift manual transmission

For fast, crisp gear changes in a sporty, manual set-up, you can choose to specify your Audi TT with short-shift manual transmission. This simple yet effective gear-change pattern means that the gearstick has a shorter distance to travel between each shift-gate, minimising the effort you have to make with each up or down-shift, whilst maximising your driving enjoyment.

quattro®

It's the technology that has given Audi the edge on the rally circuit ever since it was first introduced over 30 years ago – a technology that delivers ultimate control whilst enhancing the sporty characteristics which make the Audi TT so thrilling to drive. It's called quattro® all-wheel-drive. The principle is simple: in the same way that four brakes ensure better deceleration, four driven wheels deliver better acceleration and road-holding, pushing or pulling the car as needed, for a driving experience that's both dynamic and safe.

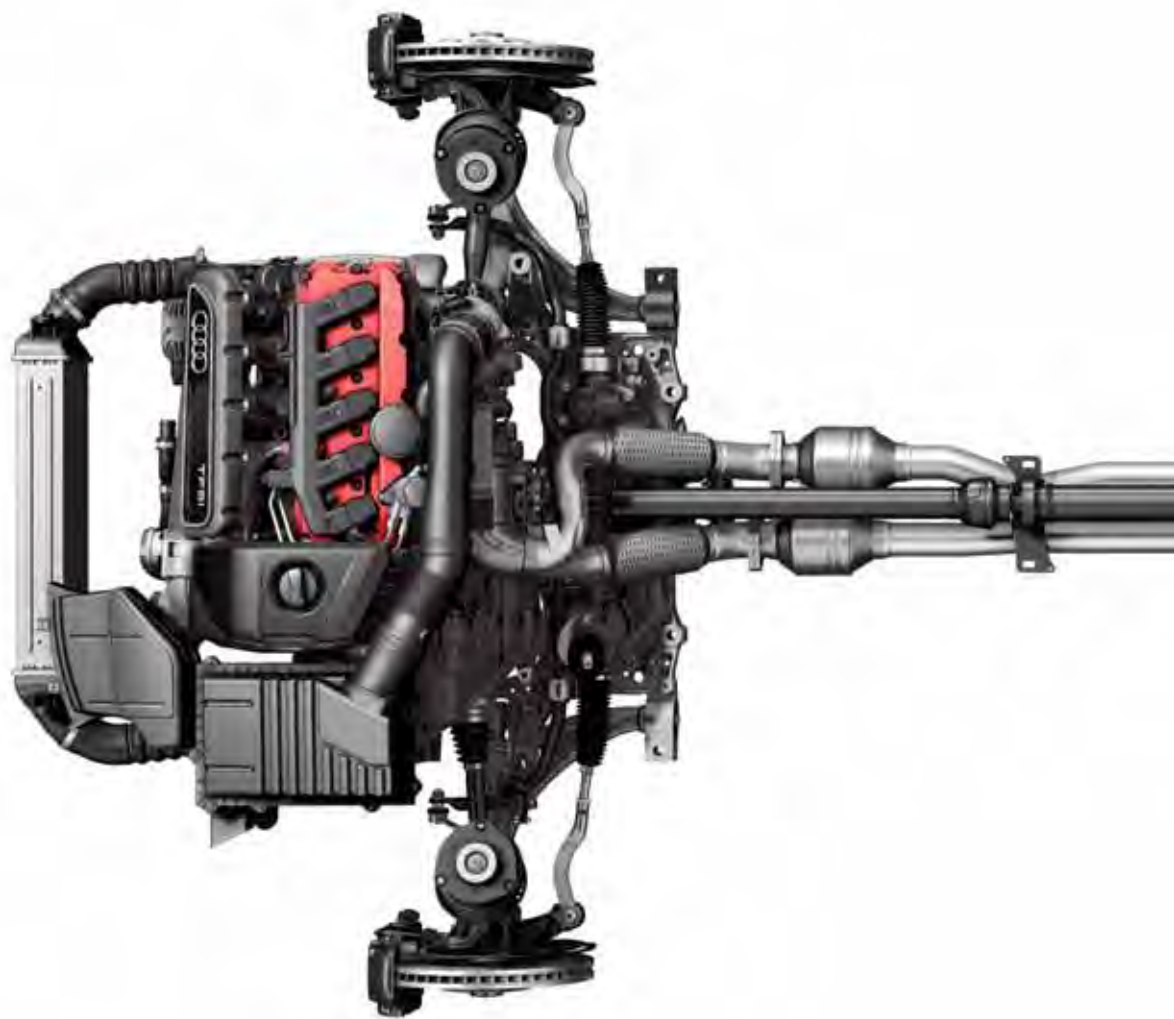

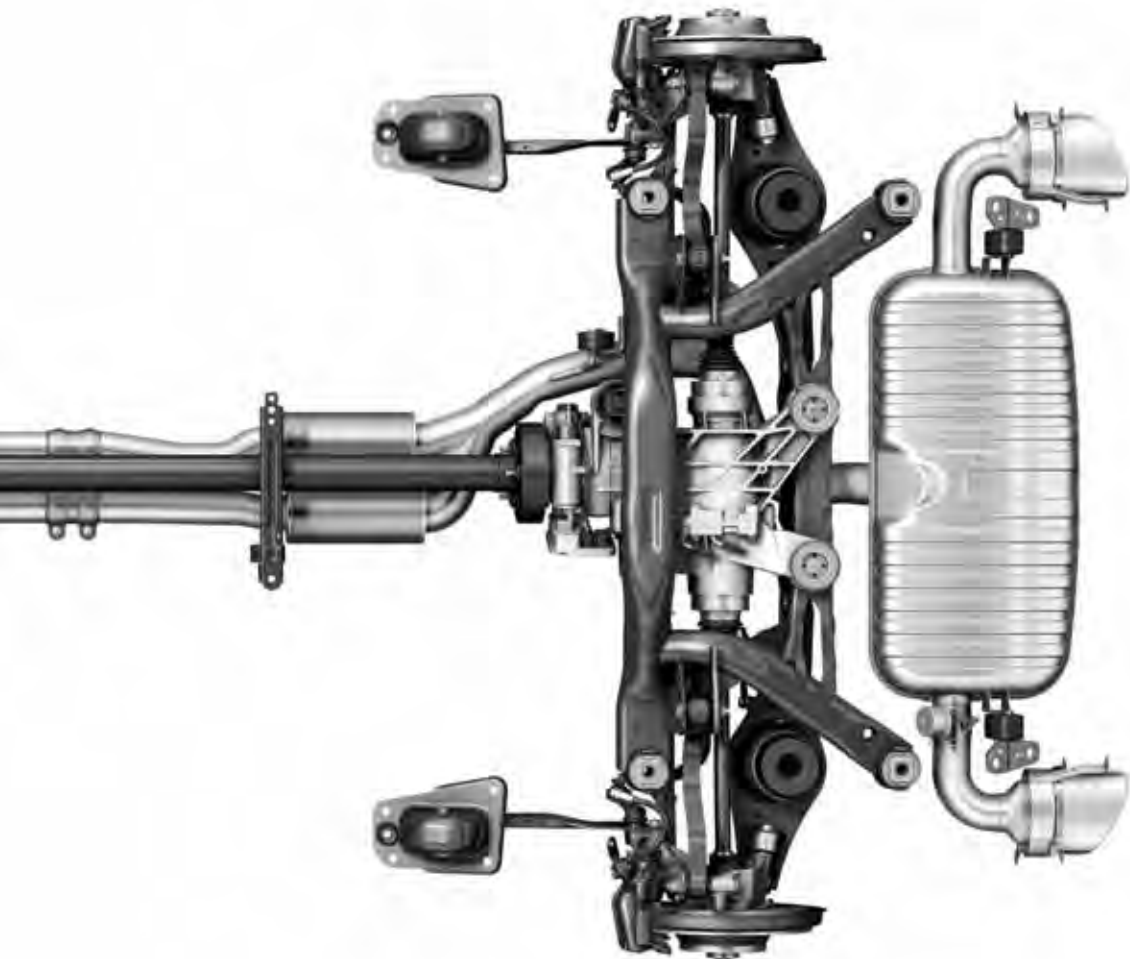

In the Audi TT, asymmetric dynamic torque distribution continuously distributes drive power between the front and rear axles, depending on weather conditions, road surface and gradient. This leads to greater flexibility and an enhanced, sportier drive.

Standard model equipment

All TT models have the following items of standard equipment

Wheels, tyres and suspension

17" x 8.5J '7-Y-spoke' design alloy wheels with 245/45 R17 Y tyres (1.8 TFSI® Roadster only)

Tyre Mobility System

Audio and communication

Chorus radio/single CD player with front speakers

Seats

Front Sports seats

Tetris cloth

Safety and security

Anti-lock Braking System (ABS)

Anti-Slip Regulation (ASR) – traction control

Anti-theft device – Thatcham Category 1 approved

Driver and front passenger airbags

Electronic Differential Lock (EDL) – traction control

Electronic Stability Programme (ESP)

First-aid kit

Front ISOFIX and front passenger airbag de-activation switch

Locking wheel bolts

Roll-over protection bars (Roadster only)

Servotronic – electromechanical, speed-sensitive, power-assisted steering

Side airbags for front seats

Tool kit and car jack

Warning triangle

Interior equipment

3-spoke Sports 'flat-bottom' design leather steering wheel

Aluminium Laser interior detailing

Black leather handbrake grip, centre console armrest pad and door handle

Driver's Information System (DIS)

Electronic climate control

Front floor mats

Fully automatic electrically-operated hood which opens in 12 seconds, with integrated wind deflector (Roadster only)

Exterior equipment

Door mirrors – electrically operated and heated

Electric front windows

Exhaust tailpipes – twin on left-hand side (2.0 TDI)

Exhaust tailpipes – dual branch (2.0 TFSI)

Front and rear fog lights

Halogen headlights

Retractable rear spoiler, which deploys and retracts automatically at set speeds or when the centre console button is pushed

Windscreen sunband (Roadster only)



Aluminium foot pedals



Retractable rear spoiler



17" x 8.5J '7-Y-spoke' design alloy wheels

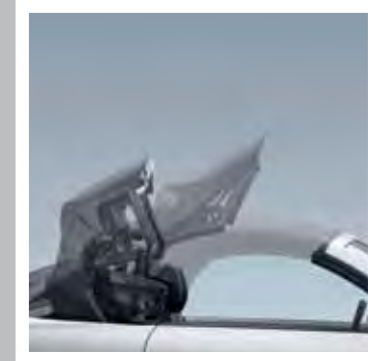

Fully automatic hood with integrated wind deflector

Sport model equipment

In addition to Standard model equipment

Basic RRP
£637.50

Total RRP inc VAT
£765.00

Wheels, tyres and suspension
17" x 8J '5-spoke V' design alloy wheels with 245/50 tyres

Audio and communication
Concert radio with single front-loading CD player, MP3 file compatibility and active front and rear speakers. Includes AUX-IN socket

Seats
Leather/Alcantara upholstery
Split-folding rear seat (Coupé only)



17" x 8J '5-spoke V' design alloy wheels



Concert radio

S line model equipment

In addition to Sport model equipment

Basic RRP
£1,658.33

Total RRP inc VAT
£1,990.00

Wheels, tyres and suspension
18" x 9J '5-spoke' design alloy wheels with 245/40 R18 tyres
S line Sports suspension lowered by 10mm

Seats
S line embossed front Sports seats

Interior equipment
3-spoke S line flat-bottom multi-function leather steering wheel (includes gear-shift paddles for S tronic models)

Black headlining
Door sill trims with S line lettering
Matt-brushed aluminium inlays
Short-shift manual gearbox

Exterior equipment
Chrome plated tailpipe
S line exterior package: S line design front and rear bumpers, side grilles and diffusers in platinum grey
Xenon headlights with headlight washers and LED daytime-running lights



18" x 9J '5-spoke' design alloy wheels



Xenon headlights with LED daytime-running lights

Black Edition model equipment

In addition to S line model equipment

2.0 TFSI 211PS and
2.0 TDI 170PS

Basic RRP

£1,041.66

Total RRP inc VAT

£1,250.00*

Wheels, tyres and suspension

19" x 9J '7 twin-spoke titanium look' design alloy wheels with 255/35 R19 tyres

Audio and communication

Symphony radio

BOSE® premium sound system

iPod connection

Mobile telephone preparation - Bluetooth interface

Exterior equipment

Black styling package, radiator grille-frame in highly-polished black, with radiator grille and number plate holder in matt black

Privacy glass, dark tinted from B pillar backwards (Coupé only)

Acoustic parking system, rear (Roadster only)



19" x 9J '7 twin-spoke titanium look' design alloy wheels



Privacy glass, dark tinted from B pillar backwards (Coupé only)



BOSE® premium sound system

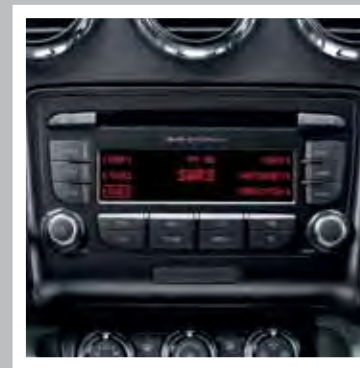

Symphony radio





TTS model equipment

Since its launch, the Audi TT has become a motoring icon. There's no mistaking its sleek curves and unique form, but there's something extra-special about the new TTS. It features 18" alloy wheels and a sports exhaust system. Its athletic 2.0-litre TFSI engine delivers 350 Nm of torque and is capable of taking you from 0 to 62mph in just 5.2 seconds*. For this model, a number of key engine components were re-engineered in order to optimise performance and handling. The result: an even more dynamic and responsive TT.

Wheels, tyres and suspension

18" x 9J '5-parallel-spoke' design alloy wheels with 245/40 R18 tyres

Audi magnetic ride – 'S' version – 10mm lower ride height

Seats

TT S embossed Silk Nappa leather upholstery – two-tone with seat centres in Silver, Magma red or Signal orange. Seat side sections and head restraints in black with decorative stitching to match seat centres. Seats also available in all-over black with silver stitching.

Heated front seats

Safety and security

ESP – with Sport mode

TTS enhanced braking system with black painted brake callipers with TTS logo

Xenon Plus headlights with LED daytime-running lights and headlight washer system

Interior equipment

3-spoke 'flat-bottom' multi-function steering wheel with TTS badge (with gear-shift paddles on S tronic models)

Extended leather package – black with decorative stitching to match seat centres

Front floor mats with leather piping to match seat centres

Instrument dials in grey with white illumination and TTS logo

Leather and aluminium gear knob with TTS logo

Matt-brushed aluminium interior detailing

Short-shift manual gearbox

Exterior equipment

Aluminium-look door mirror housings

'S' Platinum grey grille with double vertical chrome struts and TTS badge

Scuff plates with TTS logo

Sports exhaust system with twin exhaust pipes on left and right-hand side in chrome rolled finish

TTS body styling – restyled front and rear bumpers and side sill extensions



'S' Platinum grey grille



Silk Nappa leather upholstery



Instrument dials in grey with white illumination

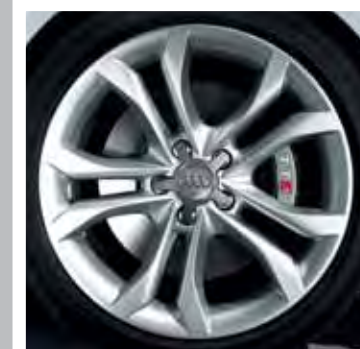

18" x 9J '5-parallel-spoke' design alloy wheels



Black Edition

In addition to TTS model equipment

Basic RRP
£1,041.66

Total RRP inc VAT
£1,250.00*

Wheels, tyres and suspension

19" x 9J '7 twin-spoke titanium look' design alloy wheels with 255/35 R19 tyres

Audio and communication

Symphony radio
BOSE® premium sound system
iPod connection
Mobile telephone preparation - Bluetooth interface

Exterior equipment

Black styling package, radiator grille-frame in highly-polished black, with radiator grille and number plate holder in matt black
Privacy glass, dark tinted from B pillar backwards (Coupé only)
Acoustic parking system, rear (Roadster only)



Leather and aluminium gear knob with TTS logo



19" x 9J '7 twin-spoke titanium look' design alloy wheels



Privacy glass, dark tinted from B pillar backwards (Coupé only)



BOSE® premium sound system

*Valid for new vehicle orders placed up to and including 30 September 2011. Offers are subject to availability
RRP - Recommended Retail Price. VAT is calculated at 20% but this may alter to reflect any change in the applicable VAT rate.

TT Coupé Sport

Engines	Power	Transmission	CO ₂ g/km	Basic RRP	Total RRP inc VAT	Recommended OTR
2.0 TFSI	211PS	6-speed manual	154	£21,941.67	£26,330.00	£27,140.00
2.0 TFSI quattro	211PS	6-speed S tronic	169	£24,366.67	£29,240.00	£30,150.00
2.0 TDI quattro	170PS	6-speed manual	139	£22,950.00	£27,540.00	£28,300.00

TT Coupé S line

Engines	Power	Transmission	CO ₂ g/km	Basic RRP	Total RRP inc VAT	Recommended OTR
2.0 TFSI	211PS	6-speed manual	154	£23,600.00	£28,320.00	£29,130.00
2.0 TFSI quattro	211PS	6-speed S tronic	169	£26,025.00	£31,230.00	£32,140.00
2.0 TDI quattro	170PS	6-speed manual	139	£24,608.33	£29,530.00	£30,290.00

TT Coupé Black Edition

Engines	Power	Transmission	CO ₂ g/km	Basic RRP	Total RRP inc VAT	Recommended OTR
2.0 TFSI	211PS	6-speed manual	154	£24,641.67	£29,570.00	£30,380.00
2.0 TFSI quattro	211PS	6-speed S tronic	169	£27,066.67	£32,480.00	£33,390.00
2.0 TDI quattro	170PS	6-speed manual	139	£25,650.00	£30,780.00	£31,540.00

Please note: The maximum power output figures are quoted in PS (or Pferdestärke, which is the metric equivalent of brake horsepower). To convert to brake horsepower, divide the PS figure by 1.0139.

Recommended On-The-Road (OTR) retail prices include: delivery charge, half a tank of fuel, number plates at £590.00 (inc. VAT), Road Fund Licence (which may vary depending on model/transmission – see page 57 for details) and first registration fee at £55.00.

RRP – Recommended Retail Price. VAT is calculated at 20% but this may alter to reflect any change in the applicable VAT rate.

TT Roadster Standard

Engines	Power	Transmission	CO ₂ g/km	Basic RRP	Total RRP inc VAT	Recommended OTR
1.8 TFSI	160PS	6-speed manual	152	£20,425.00	£24,510.00	£25,320.00

TT Roadster Sport

Engines	Power	Transmission	CO ₂ g/km	Basic RRP	Total RRP inc VAT	Recommended OTR
1.8 TFSI	160PS	6-speed manual	152	£21,062.50	£25,275.00	£26,085.00
2.0 TFSI	211PS	6-speed manual	156	£23,591.67	£28,310.00	£29,120.00
2.0 TFSI quattro	211PS	6-speed S tronic	172	£26,016.67	£31,220.00	£32,130.00
2.0 TDI quattro	170PS	6-speed manual	144	£24,600.00	£29,520.00	£30,295.00

TT Roadster S line

Engines	Power	Transmission	CO ₂ g/km	Basic RRP	Total RRP inc VAT	Recommended OTR
1.8 TFSI	160PS	6-speed manual	152	£22,720.83	£27,265.00	£28,075.00
2.0 TFSI	211PS	6-speed manual	156	£25,250.00	£30,300.00	£31,110.00
2.0 TFSI quattro	211PS	6-speed S tronic	172	£27,675.00	£33,210.00	£34,120.00
2.0 TDI quattro	170PS	6-speed manual	144	£26,258.33	£31,510.00	£32,285.00

TT Roadster Black Edition

Engines	Power	Transmission	CO ₂ g/km	Basic RRP	Total RRP inc VAT	Recommended OTR
2.0 TFSI	211PS	6-speed manual	156	£26,291.67	£31,550.00	£32,360.00
2.0 TFSI quattro	211PS	6-speed S tronic	172	£28,716.67	£34,460.00	£35,370.00
2.0 TDI quattro	170PS	6-speed manual	144	£27,300.00	£32,760.00	£33,535.00

TTS Coupé

Engines	Power	Transmission	CO ₂ g/km	Basic RRP	Total RRP inc VAT	Recommended OTR
TTS quattro	272PS	6-speed manual	184	£28,870.83	£34,645.00	£35,605.00

TTS Coupé Black Edition

Engines	Power	Transmission	CO ₂ g/km	Basic RRP	Total RRP inc VAT	Recommended OTR
TTS quattro	272PS	6-speed manual	184	£29,912.50	£35,895.00	£36,855.00

TTS Roadster

Engines	Power	Transmission	CO ₂ g/km	Basic RRP	Total RRP inc VAT	Recommended OTR
TTS quattro	272PS	6-speed manual	189	£30,520.83	£36,625.00	£37,715.00

TTS Roadster Black Edition

Engines	Power	Transmission	CO ₂ g/km	Basic RRP	Total RRP inc VAT	Recommended OTR
TTS quattro	272PS	6-speed manual	189	£31,562.50	£37,875.00	£38,965.00

Transmissions

	Automatic S tronic transmission (6-speed)	Short-shift manual transmission (standard on S line models with manual transmission)
1.8 TFSI	-	•
2.0 TFSI	•	•
2.0 TFSI quattro	S	-
2.0 TDI quattro	-	•
TTS quattro	•	S
Basic RRP	£1,233.33	£129.17
Total RRP inc VAT	£1,480.00	£155.00

- = Not available • = Available S = Standard

Audi exclusive



Every Audi is intrinsically exclusive.
It's the breathtaking design, the exceptional engineering, the Vorsprung durch Technik.
But for that special touch you can specify your new TT with options from Audi exclusive.
Whether you want a unique, custom-mixed paint colour or seats in a combination of complementary shades, Audi exclusive will enable you to drive the car you've always imagined.

Both the exclusive and standard options can be found on the following pages.



Audi exclusive line



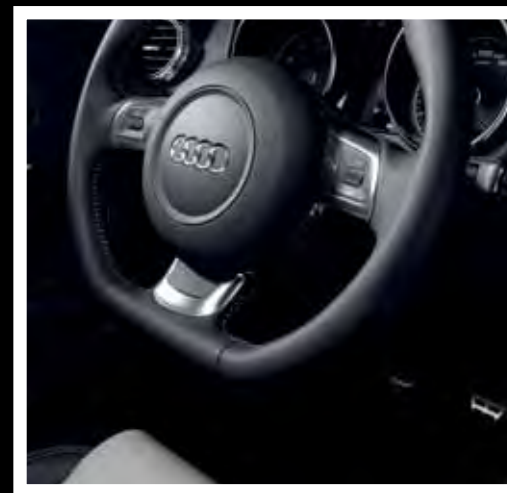
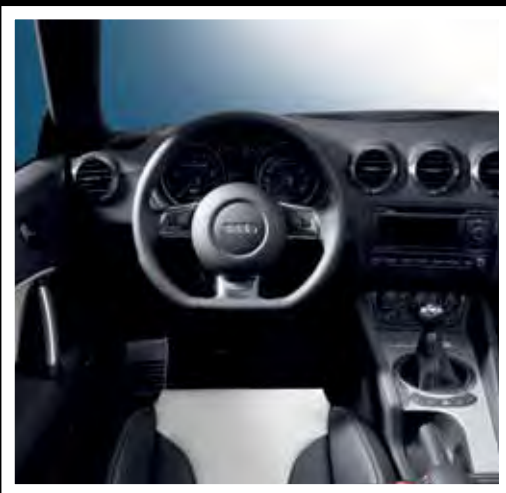

Paint and hoods

You can select one of the standard colours shown opposite or, for a different look, choose from the range of optional finishes.

Options are subject to availability and may extend delivery.

All the colour swatches on this page are matched as accurately as possible to the actual paint colours used. However, due to print processes, Audi UK cannot guarantee that colours shown are 100% accurate.

Visit your local Audi Centre for a more accurate colour swatch.

*Not available on TTS or TTS Black Edition

**Not available in combination with Daytona grey - 6Y

RRP - Recommended Retail Price.

VAT is calculated at 20% but this may alter to reflect any change in the applicable VAT rate.

Standard colours



Ibis white - T9

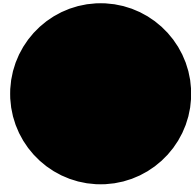

Brilliant black - A2

Optional colours



Glacier white, metallic - 2Y

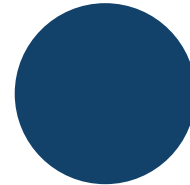

Scuba blue, metallic - 59

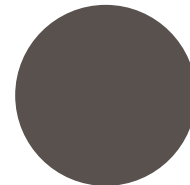

Dakota grey, metallic - Y7

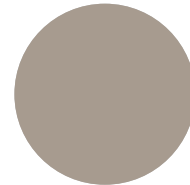

Sahara silver, metallic - 9T

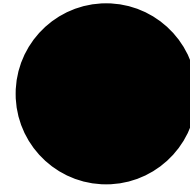

Phantom black, pearl effect - L8

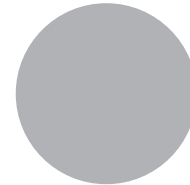

Ice silver, metallic - P5

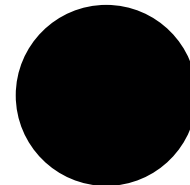

Oolong grey, metallic - 4N

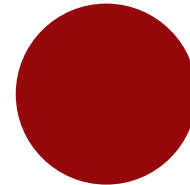

Volcano red, metallic - 1G

S line and Black Edition colours*

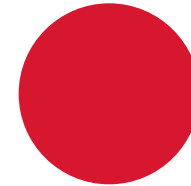

Misano red, pearl effect - N9

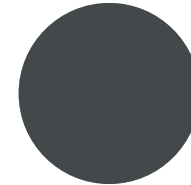

Daytona grey, pearl effect - 6Y

Optional colours

Basic RRP
£425.00

Total RRP inc VAT
£510.00

TTS colours

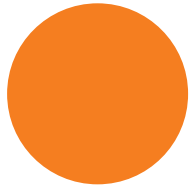

Solar orange – 3F

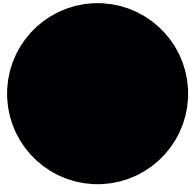

Panther black, crystal effect – H8

Hood colours

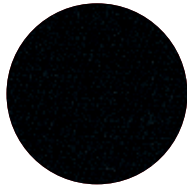

Black – PA

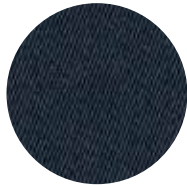

Dark grey – SW

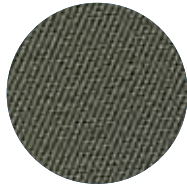

Beige – PD**

Solar orange

Basic RRP
£425.00

Total RRP inc VAT
£510.00

Panther black

Basic RRP
£625.00

Total RRP inc VAT
£750.00

Paint

Audi exclusive

Everyone has a favourite colour. No matter what yours is, Audi exclusive provides a range of unique colours that have been designed to set your car apart. Choose from the swatches here, or specify any other paint colour in the Audi range – whether it's Jet blue from the Audi R8 or Alpine white from the original Audi quattro. The choice is yours.

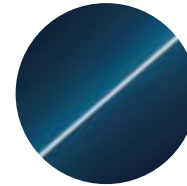

Palace blue, pearl effect

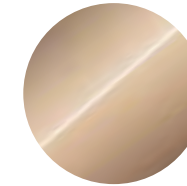

Sand beige, pearl effect

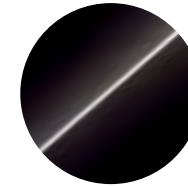

Saddle brown, pearl effect

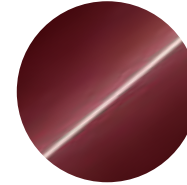

Classic red, pearl effect

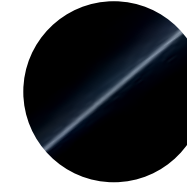

Mamba black, metallic

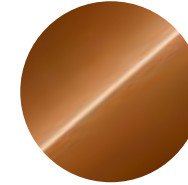

Ipanema brown, metallic



Any colour in the Audi range



100 Audi exclusive colours to choose from**

Audi exclusive

Basic RRP
£1,445.83

Total RRP inc VAT
£1,735.00

Customised

If you have a particular colour in mind, we'll mix the exact metallic or pearl-effect shade you want.*

*Custom paint is subject to factory approval, and is available for metallic and pearl-effect water-based paints only. Three-colour process colours and two-tone schemes are not available.

**Visit your local Audi Centre for colour samples.

All the colour swatches on this page are matched as accurately as possible to the actual paint colours used. However, due to print processes, Audi UK cannot guarantee that colours shown are 100% accurate.

Visit your local Audi Centre for a more accurate colour swatch.

RRP – Recommended Retail Price.

VAT is calculated at 20% but this may alter to reflect any change in the applicable VAT rate.



Customised paint

Customised

Basic RRP
£2,041.67

Total RRP inc VAT
£2,450.00

Upholstery

Standard and Sport models

Choose your favourite upholstery from the swatches shown opposite to give your car's interior the look and feel you want.









Options are subject to availability and may extend delivery.

– = Not available
● = Available
S = Standard

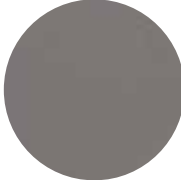
All leather upholstery choices include seats, head restraints, door inserts and front centre armrest (if fitted) in leather.

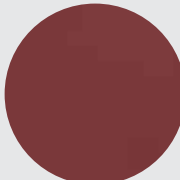

RRP – Recommended Retail Price.

VAT is calculated at 20% but this may alter to reflect any change in the applicable VAT rate.

											Standard	Sport	S line	Black Edition	TTS quattro	TTS quattro Black Edition	Basic RRP	Total RRP inc VAT			
Tetris cloth	 Black – JN																				
											S	–	–	–	–	–	–	No charge	No charge		
Leather/Alcantara	 Black – JN/YM		 Titanium grey – HG/FG/FH																		
											●	S	–	–	–	–	–	£850.00	£1,020.00		
Fine Nappa leather	 Black – JN/YM		 Titanium grey – HG/FG/FH		 Luxor beige – TB/GM/TQ																
											●	–	–	–	–	–	–	£1,325.00	£1,590.00		
	 Magma red – TR			 Nougat brown – VE		 Garnet red – VJ															
											–	●	–	–	–	–	–	–	£466.67	£560.00	

Upholstery

S line and Black Edition models

		Standard	Sport	S line	Black Edition	TTS quattro	TTS quattro Black Edition	Basic RRP	Total RRP inc VAT
Leather/Alcantara	 <p>Black with Jet grey stitching - QZ</p>	-	-	S	S	-	-	No charge	No charge
Fine Nappa leather	 <p>Black with Black stitching - QE</p>	-	-	•	•	-	-	£466.67	£560.00

TTS and TTS Black Edition models

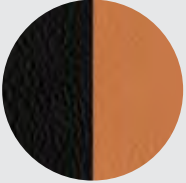
Silk Nappa leather	 <p>Black, with Silver stitching - ZM/VG</p>	 <p>Black/Spectral silver with Silver stitching - SP/VF</p>	 <p>Black/Magma red, with Magma red stitching - FA/VH</p>	-	-	-	-	S	S	No charge	No charge
	 <p>Black/Signal orange, with Signal orange stitching - ZC/VK</p>										

Options are subject to availability and may extend delivery.

- = Not available
- = Available
- S = Standard

RRP - Recommended Retail Price.

VAT is calculated at 20% but this may alter to reflect any change in the applicable VAT rate.

Upholstery

Impulse leather

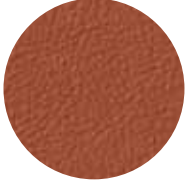
			Standard	Sport	S line	Black Edition	TTS quattro	TTS quattro Black Edition	Basic RRP	Total RRP inc VAT	
Impulse leather	 <p>Black with Silver stitching – ZM</p>	<p>Seats in Black Fine Nappa leather with moccasin seams in Black/grey and Silver stitching. Steering wheel, gear-shift gaiter, handbrake grip and centre console armrest pad in Black leather with coloured stitching. Must be combined with a multi-function steering wheel</p>	●	–	–	–	–	–	£1,566.67	£1,880.00	
			–	●	–	–	–	–	–	£679.17	£815.00
			–	–	–	–	●	●	£212.50	£255.00	
Impulse leather	 <p>Chennai brown – TZ</p>	<p>Seats in Chennai brown Fine Nappa leather with moccasin seams in Chennai brown and Espresso brown stitching. Steering wheel, gear-shift gaiter, handbrake grip and centre console armrest pad in black leather with coloured stitching. Includes extended leather package – colour on TTS. Must be combined with a multi-function steering wheel. Not in combination with extended leather package – black</p>	●	–	–	–	–	£1,566.67	£1,880.00		
			–	●	–	–	–	–	£679.17	£815.00	
			–	–	–	–	●	●	£295.83	£355.00	

Options are subject to availability and may extend delivery.

– = Not available
● = Available
S = Standard

All leather upholstery choices include seats, head restraints, door inserts and front centre armrest (if fitted) in leather.

RRP – Recommended Retail Price.

VAT is calculated at 20% but this may alter to reflect any change in the applicable VAT rate.



Impulse leather in Chennai brown (TZ) with optional Extended leather package (7HD). See page 46 for details.

Colour and trim guide

Interior trim colours

Coupé

Standard and Sport models

To help you choose the right interior for your TT, please use the guide opposite showing which carpet, dashboard and headlining colours have been matched to your chosen upholstery.

Order Code	Upholstery	Carpet	Dashboard (upper/lower)	Headlining	Leather/Alcantara (N7U)	Fine Nappa leather (N3Q)	Impulse leather (N1W)
JN	Black	Black	Black/Black	Black	●	●	—
YM	Black	Black	Black/Black	Titanium grey	●	●	—
FG	Titanium grey	Titanium grey	Black/Black	Black	●	●	—
FH	Titanium grey	Titanium grey	Black/Black	Titanium grey	●	●	—
HG	Titanium grey	Black	Black/Black	Black	●	●	—
GM	Luxor beige	Black	Black/Black	Black	—	●	—
TB	Luxor beige	Luxor beige	Black/Black	Black	—	●	—
TQ	Luxor beige	Luxor beige	Black/Black	Luxor beige	—	●	—
VJ	Garnet Red	Black	Black/Black	Black	—	●	—
TR	Magma red	Black	Black/Black	Black	—	●	—
VE	Nougat brown	Black	Black/Black	Black	—	●	—
ZM	Black with Silver stitching	Black	Black/Black	Black	—	—	●
TZ	Chennai brown	Black	Black/Black	Black	—	—	●

Order Code	Upholstery	Carpet	Dashboard (upper/lower)	Headlining	Sprint Cloth/Leather (N7V)	Leather/Alcantara (N7K)	Fine Nappa leather (N2R)
QE	Black with Black stitching	Black	Black/Black	Black	—	—	●
QZ	Black with Jet grey stitching	Black	Black/Black	Black	●	●	—

Order Code	Upholstery	Carpet	Dashboard (upper/lower)	Headlining	Leather/Alcantara (N7U)	Silk Nappa leather (N1U)	Impulse leather (N1W)
VG	Black with Silver stitching	Black	Black/Black	Titanium grey	●	●	—
SP	Black/Spectral silver	Black	Black/Black	Black	●	●	—
VF	Black/Spectral silver	Black	Black/Black	Titanium grey	●	●	—
FA	Black/Magma red	Black	Black/Black	Black	—	●	—
VH	Black/Magma red	Black	Black/Black	Titanium grey	—	●	—
ZC	Black/Signal orange	Black	Black/Black	Black	—	●	—
VK	Black/Signal orange	Black	Black/Black	Titanium grey	—	●	—
ZM	Black with Silver stitching	Black	Black/Black	Black	●	●	●
TZ	Chennai brown with Espresso brown stitching	Black	Black/Black	Black	—	—	●

Options are subject to availability and may extend delivery.

— = Not available
● = Available
S = Standard

Colour and trim guide

Interior trim colours

Roadster

Standard and Sport models

To help you choose the right interior for your TT, please use the guide opposite showing which carpet, dashboard and headlining colours have been matched to your chosen upholstery.

S line and Black Edition models

TTS and TTS Black Edition models

Options are subject to availability and may extend delivery.

– = Not available
● = Available
S = Standard

Order Code	Upholstery	Carpet	Dashboard (upper/lower)	Headlining	Tetris cloth (N2)	Leather/Alcantara (N7U)	Fine Nappa leather (N3Q)	Impulse leather (N1W)
JN	Black	Black	Black/Black	Black	●	●	●	–
FG	Titanium grey	Titanium grey	Black/Black	Black	–	●	●	–
HG	Titanium grey	Black	Black/Black	Black	–	●	●	–
TB	Luxor beige	Luxor beige	Black/Black	Black	–	–	●	–
TR	Magma red	Black	Black/Black	Black	–	–	●	–
VJ	Garnet red	Black	Black/Black	Black	–	–	●	–
TZ	Chennai brown	Black	Black/Black	Black	–	–	–	●
ZM	Black with Silver stitching	Black	Black/Black	Black	–	–	–	●

Order Code	Upholstery	Carpet	Dashboard (upper/lower)	Headlining	Leather/Alcantara (N7K)	Fine Nappa leather (N2R)
QE	Black with Black stitching	Black	Black/Black	Black	–	●
QZ	Black with Jet grey stitching	Black	Black/Black	Black	●	–

Order Code	Upholstery	Carpet	Dashboard (upper/lower)	Headlining	Leather/Alcantara (N7U)	Silk Nappa leather (N1U)	Impulse leather (N1W)
ZM	Black with Silver stitching	Black	Black/Black	Black	●	●	●
SP	Black/Spectral silver	Black	Black/Black	Black	●	●	–
FA	Black/Magma red	Black	Black/Black	Black	–	●	–
ZC	Black/Signal orange	Black	Black/Black	Black	–	●	–
TZ	Chennai brown with Espresso brown stitching	Black	Black/Black	Black	–	–	●

Upholstery

Audi exclusive

With Audi exclusive, you can specify your seats in Fine Nappa leather, in an array of different colours shown to the right.

Select just one all-over shade for each seat, or customise each panel in two or more complementary colours from the distinctive Audi exclusive palette. You can even choose the colour of the decorative stitching – to match or contrast with your chosen upholstery – from this varied collection. Whatever combination you decide upon, we think you'll be extremely comfortable with the result.



Chestnut brown



Jet grey



Alabaster white

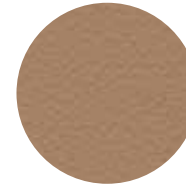

Sand beige

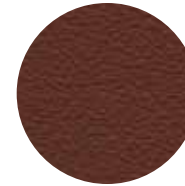

Saddle brown

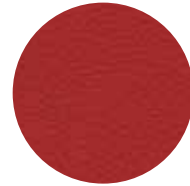

Crimson red



Magnolia white



Havana brown

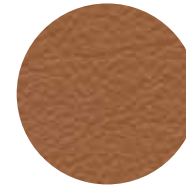

Cognac brown

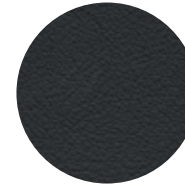

Night blue

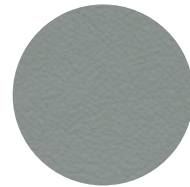

Cloudy grey



Smoky blue

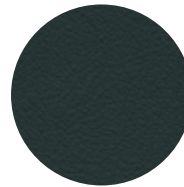

Iceland green



Powder beige



Classic red

Also available:

Alcantara colours: available in all the above Audi exclusive colours, except for Crimson red, Jet grey and Sand beige. Alcantara equivalents are Chilli red, Amethyst grey, and Sesame beige respectively.

Dashboard colours: available in all the Audi exclusive colours shown, except for Alabaster white, Magnolia white and Sand beige.

Please consult your Audi Centre for examples of Alcantara and carpet colours.

Upholstery

Audi exclusive

Order Code		Standard	Sport	S line	Black Edition	TTS quattro	TTS quattro Black Edition	Basic RRP	Total RRP inc VAT
PYA S3G	Audi exclusive leather package 1 in Fine Nappa leather. Includes leather-covered seat upholstery and door trim inserts, and floor mats with leather piping. Backrest covers and seat add-on parts come in the interior trim colour*	-	●	●	●	-	-	£1,616.67	£1,940.00
		-	-	-	-	●	●	£1,533.33	£1,840.00
PYA PS5 S3G	Audi exclusive leather package 1 in Fine Nappa leather with bucket seats. Includes all the contents of leather package 1 (PYA/S3G) plus: leather-covered front bucket seats*	-	●	●	●	-	-	£3,362.50	£4,035.00
PYC S3G	Audi exclusive leather package 1 in Fine Nappa leather/Alcantara. Includes leather-covered seat-side trims, head restraints and front centre armrest, floor mats with leather piping, Alcantara door trim inserts and seat-centre sections. Backrest covers and seat add-on parts come in the interior trim colour*	-	●	●	●	-	-	£1,616.67	£1,940.00
		-	-	-	-	●	●	£1,533.33	£1,840.00
PYG S3G	Audi exclusive leather package 2 in Fine Nappa leather. Includes all the contents of leather package 1 (PYA/S3G) plus leather-covered seat backrest covers, handbrake grip, front centre armrest, door armrests and handles, side of centre console, and dashboard. Backrest covers and seat add-on parts come in the interior trim colour*	-	●	●	●	-	-	£1,916.67	£2,300.00
		-	-	-	-	●	●	£1,833.33	£2,220.00
PYG PS5 S3G	Audi exclusive leather package 2 in Fine Nappa leather with bucket seats. Includes all the contents of leather package 1 (PYA/S3G) and leather package 2 (PYG/S3G) plus: leather-covered bucket seats*	-	●	●	●	-	-	£3,662.50	£4,395.00

Options are subject to availability and may extend delivery.

- = Not available
- = Available
- S = Standard

*Leather, stitching and piping (where applicable) can be specified in a variety of colours from the Audi exclusive range.

RRP – Recommended Retail Price.

VAT is calculated at 20% but this may alter to reflect any change in the applicable VAT rate.

Upholstery

Audi exclusive line

Audi exclusive is ultimately about choice – but if you’d rather leave some of the decisions in the capable hands of our designers, the expert team at quattro GmbH have compiled Audi exclusive line, combining some of the most popular elements of the exclusive range in one, beautifully coordinated package.

Order Code		Standard	Sport	S line	Black Edition	TTS quattro	TTS quattro Black Edition	Basic RRP	Total RRP inc VAT
WQK 7HC 1XW 1XX	Audi exclusive line	–	•	–	–	–	–	£1,487.50	£1,785.00

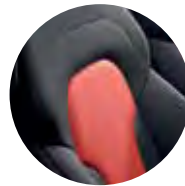

Crimson red – QY



Saddle brown – XA



Signal orange – XB



Silver – QL

The package includes

- ▶ Sports seats in two-tone Fine Nappa leather, with black seat-side sections with coloured stitching and coloured seat-centre section in Crimson red, Saddle brown, Signal orange and Silver
- ▶ Door-trim inserts to match interior trim
- ▶ 3-spoke Sports ‘flat-bottom’ design leather steering wheel, handbrake grip and gear-lever gaiter stitching to match seat centres
- ▶ Head restraints with coloured stitching in matching colour to seat-centre section
- ▶ Black dashboard and carpets
- ▶ Black cloth headlining
- ▶ Audi exclusive door sill trims
- ▶ Floor mats in black with coloured piping (to match seat-centre section)
- ▶ Extended leather package (instrument panel cover, door armrest and sides of centre console) in black leather with stitching to match seat centres

Options are subject to availability and may extend delivery.

– = Not available
• = Available
S = Standard

RRP – Recommended Retail Price.

VAT is calculated at 20% but this may alter to reflect any change in the applicable VAT rate.

Inlays

Inlays are the all-important finishing touch that add flair and interest to your car's interior.

Order Code		Standard	Sport	S line	Black Edition	TTS quattro	TTS quattro Black Edition	Basic RRP	Total RRP inc VAT
5TH	Aluminium laser	S	S	-	-	-	-	No charge	No charge
5TG	Matt-brushed aluminium	-	-	S	S	S	S	No charge	No charge



Aluminium laser – 5TH



Matt-brushed aluminium – 5TG

Options are subject to availability and may extend delivery.

- = Not available
- = Available
- S = Standard

RRP – Recommended Retail Price.

VAT is calculated at 20% but this may alter to reflect any change in the applicable VAT rate.

Wheels, tyres and suspension

Choose a set of specially-selected alloy wheels to subtly enhance the way your car looks and drives.



18" x 9J '5-arm Dynamic'
design alloy wheels - PRD



18" x 9J '10-spoke'
design alloy wheels - PQ5



18" x 9J '10-spoke'
design alloy wheels - PRM



19" x 9J '7 twin-spoke'
design alloy wheels - PQF



19" x 9J '5-segment-spoke'
design alloy wheels - PQ6



19" x 9J '5-spoke Star'
design alloy wheels - PQG

Wheels, tyres and suspension

Order Code		Standard	Sport	S line	Black Edition	TTS quattro	TTS quattro Black Edition	Basic RRP	Total RRP inc VAT
PRD	18" x 9J '5-arm Dynamic' design alloy wheels with 245/40 R18 tyres	●	-	-	-	-	-	£1,233.33	£1,480.00
		-	●	-	-	-	-	£1,066.67	£1,280.00
PQ5	18" x 9J '10-spoke' design alloy wheels with 245/40 R18 Y tyres	●	-	-	-	-	-	£1,233.33	£1,480.00
		-	●	-	-	-	-	£1,066.67	£1,280.00
PRM	18" x 9J '10-spoke' design alloy wheels with 245/40 R18 tyres	-	-	●	-	-	-	£316.67	£380.00
		●	-	-	-	-	-	£1,233.33	£1,480.00
PQS	19" x 9J '20-spoke' design two-piece alloy wheels with 255/35 R19 Y tyres	-	●	-	-	-	-	£1,408.33	£1,690.00
		-	-	●	-	●	-	£658.33	£790.00
PQF	19" x 9J '7 twin-spoke' design alloy wheels with 255/35 R19 Y tyres	●	-	-	-	-	-	£1,575.00	£1,890.00
		-	●	-	-	-	-	£1,408.33	£1,690.00
		-	-	●	-	●	-	£658.33	£790.00
		-	-	-	●	-	●	No charge	No charge
PQ6	19" x 9J '5-segment-spoke' design alloy wheels with 255/35 R19 Y tyres	●	-	-	-	-	-	£1,575.00	£1,890.00
		-	●	-	-	-	-	£1,408.33	£1,690.00
PQG	19" x 9J '5-spoke Star' design alloy wheels with 255/35 R19 Y tyres	-	-	●	-	●	-	£658.33	£790.00
		-	-	-	-	●	-	£658.33	£790.00
PDH PC2	Audi magnetic ride. Adaptive suspension system with two selectable modes (Normal or Sport). Sensors in the car monitor the road conditions and adjust the damping effect by varying a magnetic charge which passes through a fluid-based shock absorber for improved road handling, outstanding chassis control and excellent driving comfort. Includes painted brake callipers in grey. Replaces Sports suspension on S line models	●	●	●	●	S*	S*	£979.17	£1,175.00
1BV	Sports suspension. 10mm lower ride height with stiffer damper and spring rates. Not in combination with Audi magnetic ride	●	●	S	S	-	-	£362.50	£435.00
2H3	Sport button - more direct response for accelerating and steering. Only in combination with Audi magnetic ride	●	●	●	●	●	●	£295.83	£355.00

*Audi magnetic ride on TTS has a 10mm lower ride height than standard Audi magnetic ride.

Options are subject to availability and may extend delivery.

- = Not available
● = Available
S = Standard

RRP - Recommended Retail Price.

VAT is calculated at 20% but this may alter to reflect any change in the applicable VAT rate.

Packages

Some items work well together, which is why we've created these special packages. They provide increased convenience and value by combining several of our most popular options.

Order Code		Standard	Sport	S line	Black Edition	TTS quattro	TTS quattro Black Edition	Basic RRP	Total RRP inc VAT
WB1	Comfort package. Acoustic parking system (rear only), cruise control, auto-dimming rear-view mirror and light and rain sensors. Also includes windscreen sunband on Coupé models. Not available in combination with light and rain sensor package	●	●	●	●	●	●	£425.00	£510.00
WB3 UF1	Sound package. BOSE® premium sound system, Symphony radio and iPod connection. USB connection can be selected in lieu of iPod. Not available in combination with technology package, Satellite Navigation systems, AMI or CD changer	●	●	●	S	●	S	£425.00	£510.00
WB4 UF7 9ZX	Technology package. Satellite Navigation system – DVD-based, Bluetooth interface and Audi Music Interface. CD changer can be selected in lieu of AMI. Only in combination with multi-function steering wheel. Not available in combination with sound package, iPod or USB connection. Please note AMI deletes iPod connection on Black Edition models	–	●	●	–	●	–	£1,270.83	£1,525.00
		–	–	–	●	–	●	£1,062.50	£1,275.00

Options are subject to availability and may extend delivery.

- = Available
- = Not available
- S = Standard

RRP – Recommended Retail Price.

VAT is calculated at 20% but this may alter to reflect any change in the applicable VAT rate.



Satellite Navigation system – DVD-based



BOSE® premium sound system



Audio and communication

Stay in touch using our range of communication functions, and give each journey its own soundtrack with our advanced audio equipment.

Options are subject to availability and may extend delivery.

- = Available
- = Not available
- S = Standard

RRP – Recommended Retail Price.

VAT is calculated at 20% but this may alter to reflect any change in the applicable VAT rate.

* uses 5-digit postcode recognition

Order Code		Standard	Sport	S line	Black Edition	TTS quattro	TTS quattro Black Edition	Basic RRP	Total RRP inc VAT
RCL	Concert radio. AM/FM twin tuner with TP memo function. Single front-loading CD player with MP3 compatibility. Active front and rear speakers. Includes AUX-IN socket	●	S	S	–	S	S	£187.50	£225.00
RSL	Symphony radio. AM/FM twin tuner with TP memo function. Front-loading 6-CD changer with MP3 compatibility and active front and rear speakers. Includes AUX-IN socket	●	–	–	S	–	S	£412.50	£495.00
8RY	BOSE® surround sound system. Dynamic noise-compensation, 8-channel amplifier, 12 loudspeakers including centre speaker in the dashboard and 2 surround sound loudspeakers in the rear shelf. Total output of 255 Watts. Cannot be combined with Chorus radio	–	●	●	–	●	–	£225.00	£270.00
8RY	BOSE® surround sound system. Dynamic noise-compensation, 8-channel amplifier, 12 loudspeakers including centre speaker in the dashboard and 2 surround sound loudspeakers in the rear shelf. Total output of 255 Watts. Cannot be combined with Chorus radio	●	●	●	S	●	S	£404.17	£485.00
PNX 7RF	Satellite Navigation system – CD-ROM based*. Route-planning and guidance using voice and pictogram instructions. Includes AM/FM radio with TP memo function. Single front-loading CD player with MP3-compatibility. Includes AUX-IN socket, MMI operating logic and UK CD-ROM disc. Please note that this option does not include UK TMC functionality. Limited use of navigation system possible when playing audio CDs, so a CD changer, USB or iPod connection is recommended with this option	●	–	–	–	–	–	£741.67	£890.00
PNX 7RF	Satellite Navigation system – CD-ROM based*. Route-planning and guidance using voice and pictogram instructions. Includes AM/FM radio with TP memo function. Single front-loading CD player with MP3-compatibility. Includes AUX-IN socket, MMI operating logic and UK CD-ROM disc. Please note that this option does not include UK TMC functionality. Limited use of navigation system possible when playing audio CDs, so a CD changer, USB or iPod connection is recommended with this option	–	●	●	●	●	●	£554.17	£665.00
PNC	Satellite Navigation system – DVD-based*. Integrated into the MMI is a clear map display with special destinations indicated by symbols, high-speed map loading, zoom function, selection of address book destinations, target memory, dynamic route guidance with TMC (with vehicle life subscription), including Europe DVD (where digitised), and Satellite Navigation disc-reader located in the spare-wheel well under the boot. Audio or MP3 CDs cannot be used at the same time as the DVD-based navigation system, so CD changer or AMI is recommended. Not available in combination with iPod connection or USB connection	●	–	–	–	–	–	£1,591.67	£1,910.00
PNC	Satellite Navigation system – DVD-based*. Integrated into the MMI is a clear map display with special destinations indicated by symbols, high-speed map loading, zoom function, selection of address book destinations, target memory, dynamic route guidance with TMC (with vehicle life subscription), including Europe DVD (where digitised), and Satellite Navigation disc-reader located in the spare-wheel well under the boot. Audio or MP3 CDs cannot be used at the same time as the DVD-based navigation system, so CD changer or AMI is recommended. Not available in combination with iPod connection or USB connection	–	●	●	●	●	●	£1,404.17	£1,685.00
QV9	TV reception – analogue and digital. TV tuner for reception of 'free-to-air' TV channels. Picture display only possible on MMI screen when vehicle is stationary, audio available at all times. Reception dependent upon local digital network availability. Only in combination with DVD-based Satellite Navigation system. On Roadster only available in combination with comfort package or light and rain sensor package	●	●	●	●	●	●	£679.17	£815.00



Symphony radio



Satellite Navigation system – DVD-based

Audio and communication

Order Code		Standard	Sport	S line	Black Edition	TTS quattro	TTS quattro Black Edition	Basic RRP	Total RRP inc VAT
9ZX	Mobile telephone preparation – Bluetooth interface provides handsfree connection via Bluetooth using mobile phone aerial. Please contact your Audi Centre for phone compatibility. Only in combination with multi-function steering wheel	●	●	●	S	●	S	£208.33	£250.00
9ZF	Mobile telephone preparation – Low with Bluetooth and voice control. Provides handsfree connection via Bluetooth using mobile phone aerial. Alternatively, it can use a cradle with charging facility for optimal reception via external aerial. Cradle available at extra cost – please contact your Audi Centre for phone compatibility. Only in combination with a multi-function steering wheel. Voice control is not available on Roadster models. Located on centre console between front seats	●	●	●	–	●	–	£329.17	£395.00
		–	–	–	●	–	●	£120.83	£145.00
	In combination with technology package	–	●	●	●	●	●	£120.83	£145.00
UF1	iPod connection. For playing/charging your iPod. Located in glovebox and controllable via radio or multi-function steering wheel (if fitted). Cannot be combined with CD changer, USB connection, AMI, Satellite Navigation system – DVD-based or technology package	●	●	●	S	●	S	£154.17	£185.00
UF2	USB connection. For playing music from your USB stick. Located in glovebox and controlled via radio or multi-function steering wheel (if fitted). Cannot be combined with CD changer, iPod connection, AMI, Satellite Navigation system – DVD-based or technology package	●	●	●	●	●	●	£154.17	£185.00
UF7	Audi Music Interface (AMI). Universal connection for use with stereo audio sources, USB and MP3 devices including Apple iPod generation 4 onwards (iPod, iPod classic, iPod mini, iPod nano, iPod photo, iPod video, iPod touch). Provides intuitive control through the audio system and multi-function steering wheel, where fitted. It also replicates the iPod display on the audio screen and DIS, including track titles. The interface provides charging function (dependent on device). Only in combination with DVD-based Satellite Navigation system. Not in combination with iPod connection. Please note AMI deletes iPod connection on Black Edition models	●	●	●	●	●	●	£212.50	£255.00
7A2	CD changer. For six CDs, located in glovebox and controllable via radio or multi-function steering wheel (if fitted). Cannot be combined with iPod, USB connection or AMI. Please note AMI deletes iPod connection on Black Edition models	●	●	●	●	●	●	£270.83	£325.00

Options are subject to availability and may extend delivery.

- = Available
- = Not available
- S = Standard

RRP – Recommended Retail Price.

VAT is calculated at 20% but this may alter to reflect any change in the applicable VAT rate.



iPod connection



Mobile telephone preparation – Low

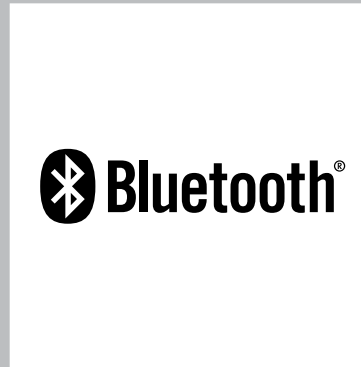

Mobile telephone preparation – Bluetooth interface

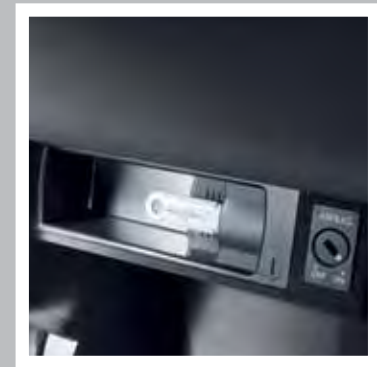

USB connection

Seats

Choose from a variety of different comfort and styling options to tailor your driving experience.

Order Code		Standard	Sport	S line	Black Edition	TTS quattro	TTS quattro Black Edition	Basic RRP	Total RRP inc VAT
4A3	Heated front seats. Individually controlled variable temperature adjustment	●	●	●	●	S	S	£212.50	£255.00
PV1	Electrically-adjustable front seats. Includes adjustment for height, forwards and backwards position, backrest angle and lumbar support	●	●	●	●	●	●	£616.67	£740.00
7P1	Electric lumbar support. For front seats with horizontal and vertical adjustment	●	●	●	●	●	●	£162.50	£195.00
PS5	Front bucket seats in black Fine Nappa leather upholstery with manual adjustment. Please note, this option deletes front ISOFIX seats, S line or TTS embossing and front airbag deactivation. Not available in combination with storage package, through-load facility, electric front seats, electric lumbar support or any other seat upholstery option	●	-	-	-	-	-	£2,958.33	£3,550.00
		-	●	●	●	-	-	£2,108.33	£2,530.00
		-	-	-	-	●	●	£1,633.33	£1,960.00
3X2	Through-load facility. Includes removable ski bag for transporting long objects. Roadster only	●	●	●	●	●	●	£79.17	£95.00

Options are subject to availability and may extend delivery.

- = Available
- = Not available
- S = Standard

RRP – Recommended Retail Price.

VAT is calculated at 20% but this may alter to reflect any change in the applicable VAT rate.



Electrically-adjustable front seats



Heated front seats

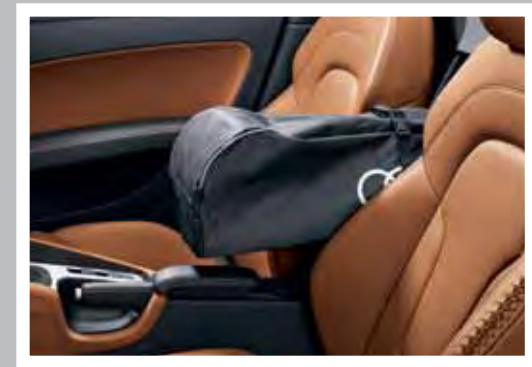

Through-load facility

Safety and security

Intelligent technology designed to give you better all-round awareness and safety on the road.

Order Code		Standard	Sport	S line	Black Edition	TTS quattro	TTS quattro Black Edition	Basic RRP	Total RRP inc VAT
UG1	Audi hill-hold assist. Prevents roll-back on hills for up to 5 seconds by maintaining brake force	●	●	●	●	●	●	£75.00	£90.00
7X1	Acoustic parking system (rear only). Aids parking by acoustically indicating distances to obstacles. Standard on TT Roadster Black Edition models	●	●	●	●	●	●	£254.17	£305.00
6XK	Auto-dimming and folding door mirrors. Only in combination with comfort package	●	●	●	●	●	●	£287.50	£345.00
6XE	Door mirrors – electrically folding	●	●	●	●	●	●	£104.17	£125.00
3B4	ISOFIX child-seat preparation for outer rear seats. Only available on Coupé models	–	●	●	●	●	●	£29.17	£35.00
6XK 4L6 4GP	Light and rain sensor package. Includes auto-dimming rear-view mirror and door mirrors, automatic headlight activation, automatic windscreen wipers and sunband for windscreen. Also includes electrically folding door mirrors. Not available in combination with comfort package	●	●	●	●	●	●	£383.33	£460.00
7K6	Tyre pressure loss indicator. A visual and acoustic warning when the system detects a potential loss of tyre pressure	●	●	●	●	●	●	£62.50	£75.00
4GP	Windscreen sunband. Coupé only	●	●	●	●	●	●	£45.83	£55.00

Exterior equipment

Make sure your car looks exactly as you want it to by selecting some of our striking options.

Options are subject to availability and may extend delivery.

- = Available
- = Not available
- S = Standard

RRP – Recommended Retail Price.

VAT is calculated at 20% but this may alter to reflect any change in the applicable VAT rate.

Order Code		Standard	Sport	S line	Black Edition	TTS quattro	TTS quattro Black Edition	Basic RRP	Total RRP inc VAT
2Z0	Deletion of model designation at rear	–	–	–	–	●	●	No charge	No charge
2Z7	Deletion of engine technology designation at rear	●	●	●	●	–	–	No charge	No charge
8N7	High-beam assist. Automatically adjusts headlights from high-beam to dipped-beam when another vehicle is approaching. Only in combination with light and rain sensor package or comfort package	●	●	●	●	●	●	£83.33	£100.00
PX4 8Q5	Adaptive headlights. Swivelling headlights for improved illumination of a winding road. Includes Xenon Plus headlights with headlight washers. Also includes light styling pack with chrome-detailed headlight surrounds and darkened rear light clusters	●	●	–	–	–	–	£829.17	£995.00
VW1	Privacy glass. Dark tinted glass from B pillar backwards. Only available on Coupé	–	●	●	S	●	S	£275.00	£330.00
4ZM	Black styling package. Radiator grille-frame in highly polished black, with radiator grille and number plate holder in matt black	–	●	●	S	●	S	£254.17	£305.00

Interior equipment

Specify every detail of your car's interior with this range of exclusive options.

Options are subject to availability and may extend delivery.

- = Available
- = Not available
- S = Standard

*HomeLink® is a registered trademark of Johnson Controls. For information on compatibility, visit www.homelink.com

RRP – Recommended Retail Price.

VAT is calculated at 20% but this may alter to reflect any change in the applicable VAT rate.

Order Code		Standard	Sport	S line	Black Edition	TTS quattro	TTS quattro Black Edition	Basic RRP	Total RRP inc VAT
QQ1	Interior light package. Includes front footwell lighting, illuminated vanity mirrors (Coupé only), interior door handles and glovebox, puddle and ambient lighting	•	•	•	•	•	•	£104.17	£125.00
QE1	Storage package. Comprising storage net in front passenger footwell and front seat backrests, storage compartment under the front seats. Also includes luggage net in boot on Coupé	-	•	•	•	•	•	£104.17	£125.00
8T2	Cruise control. For holding any speed above 25mph	•	•	•	•	•	•	£183.33	£220.00
7HC	Extended leather package – black. Includes instrument panel cover, door armrest and side of centre console	-	•	•	•	S	S	£304.17	£365.00
7HD	Extended leather package – coloured. Includes side of centre console in the same colour as seat upholstery and instrument panel cover in black leather. In combination with Magma red or Mustang brown – the door armrest and door handle are in black leather. In combination with Chennai brown, TTS Silk Nappa leather interior colours or exclusive line – the door armrest and door handle are in black leather with coloured stitching to match seat centres. In combination with Mineral grey, Light grey and Luxor beige interior colours – the door armrest is in coloured leather to match seat upholstery (not available in combination with black leather interior)	-	•	-	-	-	-	£383.33	£460.00
VC1	Garage door opener (Homelink®*). Programmable radio-operated remote control for compatible doors/gates. Control buttons integrated in the front roof module	•	•	•	•	•	•	£150.00	£180.00
1XW 1XX	3-spoke multi-function flat-bottomed steering wheel. Includes gear-shift paddles on S tronic® models	•	•	S	S	S	S	£154.17	£185.00



Extended leather package – coloured



Cruise control

Interior equipment

Order Code		Standard	Sport	S line	Black Edition	TTS quattro	TTS quattro Black Edition	Basic RRP	Total RRP inc VAT
YRH S3G	Audi exclusive leather-covered steering wheel rim*	•	•	•	•	•	•	£287.50	£345.00
YRB S3G	Audi exclusive controls package.* Includes leather-covered steering wheel rim, handbrake grip and gear-shift gaiter	•	•	•	•	•	•	£512.50	£615.00
YUG S3G	Audi exclusive leather-covered roll-over protection bars.* Only available on Roadster models	•	•	•	•	•	•	£425.00	£510.00
YSK S3G	Audi exclusive headlining in Alcantara.* Only available on Coupé models	•	•	•	•	•	•	£1,350.00	£1,620.00
YTO S3G	Audi exclusive seat belts*	Roadster	•	•	•	•	•	£650.00	£780.00
		Coupé	•	•	•	•	•	£1,333.33	£1,360.00

Options are subject to availability and may extend delivery.

- = Available
- = Not available
- S = Standard

*Leather, stitching and seat belt colour (where applicable) can be specified in a variety of colours from the Audi exclusive range.

RRP – Recommended Retail Price.

VAT is calculated at 20% but this may alter to reflect any change in the applicable VAT rate.



Audi exclusive steering wheel



Audi exclusive controls package



Audi exclusive door armrest

Audi Complete

Audi Complete is simply a way to look after the servicing and maintenance costs for your Audi in a single package. You pay a one-off or monthly fee and we'll cover all your servicing, maintenance and tyres for the next three years including your first MOT and a full 5-year warranty. It means you only have to pay for fuel, insurance and your Road Fund Licence. So you can be reassured that your car will be maintained by trained Audi Technicians, using genuine Audi parts.

*Retail customers only. Pricing based on 3 years/30,000 miles (whichever occurs sooner). All pricing is a 'starting from' price for the Audi TT model range and is therefore subject to change and mileage/model dependent.

Warranty

Options are subject to availability and may extend delivery.

- = Not available
• = Available
S = Standard

**Only available prior to registration of your TT. Please speak to your Audi Centre for full details.

RRP - Recommended Retail Price.

VAT is calculated at 20% but this may alter to reflect any change in the applicable VAT rate.

Order Code		TT	TTS	Basic RRP	Total RRP inc VAT
AC1	Audi Complete – Service, Maintenance and 5-year warranty. Comprehensive care for your Audi covering all your servicing and maintenance for 3 years, as well as your first MOT and a full 5-year/90,000 mile warranty. Visit your local Audi Centre for further information or audi.co.uk/audicomplete for full details including terms and conditions	•	–	£27.50	£33.00*
		–	•	£37.50	£45.00*
AC2	Audi Complete – Service, Maintenance, Tyres and 5-year warranty. Comprehensive care for your Audi covering all your servicing, maintenance and tyres for 3 years, as well as your first MOT and a full 5-year/90,000 mile warranty. Visit your local Audi Centre for further information or audi.co.uk/audicomplete for full details including terms and conditions	•	–	£41.67	£50.00*
		–	•	£58.33	£70.00*

Order Code		TT	TTS	Basic RRP	Total RRP inc VAT
-	Audi Warranty , covering you for unlimited mileage in the first 2 years of ownership, and up to 60,000 miles in the third year. Transferable between owners**	S	S	No charge	No charge
EA6	Audi Warranty , covering you for up to 4 years or 75,000 miles, whichever comes soonest. Cover includes a 2-year unlimited mileage warranty, and up to 75,000 miles in the third and fourth years. Transferable between owners**	•	•	£320.83	£385.00
EA9	Audi Warranty , covering you for up to 5 years or 90,000 miles, whichever comes soonest. Cover includes a 2-year unlimited mileage warranty, and up to 90,000 miles in the third, fourth and fifth years. Transferable between owners**	•	•	£754.17	£905.00

Merchandise

From the enthusiasts' motorsport collection to the sophisticated Audi collection, there's a wide variety of adults' and children's clothing, lifestyle accessories and collectables, all of which bear the Audi name.

Please speak to a member of our team at your local Audi Centre to see the full Audi collection and to place an order. A selection of Audi merchandise is also available to buy from audi.co.uk/merchandise.



Audi kids



Bags and leather goods



Clothing



Motorsports



Sport and travel



Model cars

Accessories

Choosing an Audi isn't just a matter of deciding on the model you want; it's about creating a car that suits your needs perfectly. And that's why we've developed a whole range of accessories to enhance your TT, enabling you to customise it down to the last detail. Like your Audi, all these accessories are developed to the highest possible standards. And they're all available exclusively from Audi.

To find out more, just visit audi.co.uk/accessories or contact your local Audi Centre.

Warranty

All the accessories available on the TT are covered by a three-year warranty* if they are ordered and included in the purchase price of the car at date of delivery. Any accessories ordered and installed after delivery include a two-year warranty.*



Sport and design



Transport and touring

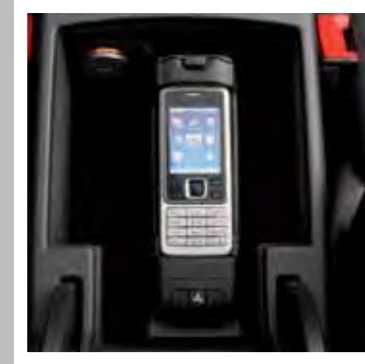

Entertainment and communication



Comfort and protection

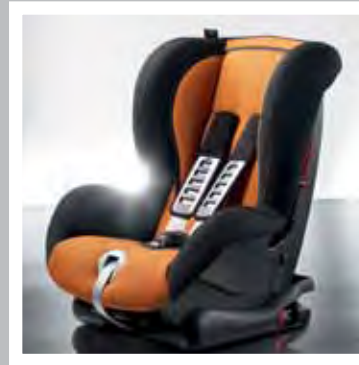

Family



Safety and security

*Excluding Road Angel products.
Audi Accessories warranty terms and conditions can be found at audi.co.uk

TT Coupé

technical data

Engine	Petrol					Diesel
	2.0 TFSI	2.0 TFSI	2.0 TFSI quattro	TTS quattro	TTS quattro	2.0 TDI quattro
Transmission	6-speed manual	6-speed S tronic	6-speed S tronic	6-speed manual	6-speed S tronic	6-speed manual
Cylinder	4-cylinder	4-cylinder	4-cylinder	4-cylinder	4-cylinder	4-cylinder
Displacement, cubic cm (valves per cylinder)	1984 (4)	1984 (4)	1984 (4)	1984 (4)	1984 (4)	1968 (4)
Max. power ¹ , PS at rpm	211/4300-6000	211/4300-6000	211/4300-6000	272/6000	272/6000	170/4200
Max. torque, Nm at rpm	350/1600-4200	350/1600-4200	350/1600-4200	350/2500-5000	350/2500-5000	350/1750-2500
0-62mph acceleration, seconds	6.1	6.0	5.6	5.4	5.2	7.5
Top speed, mph	152	152	150	155 ²	155 ²	140
CO ₂ emissions ³ , g/km	154	164	169	184	179	139
Benefit in kind (BIK)%	20	22	23	26	25	20
Fuel consumption ³ , mpg (l/100km) Urban	31.7 (8.9)	28.5 (9.9)	28.5 (9.9)	26.2 (10.8)	26.6 (10.6)	40.4 (7.0)
Fuel consumption ³ , mpg (l/100km) Extra Urban	54.3 (5.2)	52.3 (5.4)	49.6 (5.7)	45.6 (6.2)	47.1 (6.0)	65.7 (4.3)
Fuel consumption ³ , mpg (l/100km) Combined	42.8 (6.6)	39.8 (7.1)	39.2 (7.2)	35.8 (7.9)	36.7 (7.7)	53.3 (5.3)
ABI insurance group 1-50*	34 E	34 E	34 E	38 E	38 E	32 E
Unladen weight ⁴ , kg	1260	1280	1360	1395	1415	1370
Gross weight limit, kg	1660	1680	1760	1795	1815	1770
Roof/Boot lid load limit, kg	75	75	75	75	75	75
Luggage compartment capacity, litres	290/700	290/700	290/700	290/700	290/700	290/700
Fuel tank capacity approx, litres	55	55	60	60	60	60

*Highest insurance group rating shown. Group may be lower dependent on trim level. Please visit www.thatcham.org/abigrouprating for details.

¹The given values have been determined according to the prescribed measurement process (the latest version of Directive 80/1269/EEC).

²Regulated.

³Fuel consumption and CO₂ emissions figures are obtained under standardised test conditions (Directive 93/116/EEC) using a representative model. This allows direct comparison between different models from different manufacturers, but may not represent the actual fuel consumption achieved in 'real world' driving conditions. More information is available at www.vca.gov.uk.

⁴Vehicle unladen weight without driver (calculated in accordance with the current applicable version of Directive 92/21/EEC). Optional equipment may increase the car's unladen weight and drag coefficient, whereby the possible payload limit and top speed will be correspondingly reduced.

TT Roadster technical data

Engine	Petrol						Diesel
	1.8 TFSI	2.0 TFSI	2.0 TFSI	2.0 TFSI quattro	TTS quattro	TTS quattro	2.0 TDI quattro
Transmission	6-speed manual	6-speed manual	6-speed S tronic	6-speed S tronic	6-speed manual	6-speed S tronic	6-speed manual
Cylinder	4-cylinder	4-cylinder	4-cylinder	4-cylinder	4-cylinder	4-cylinder	4-cylinder
Displacement, cubic cm (valves per cylinder)	1798 (4)	1984 (4)	1984 (4)	1984 (4)	1984 (4)	1984 (4)	1968 (4)
Max. power ¹ , PS at rpm	160/4500-6300	211/4300-6000	211/4300-6000	211/4300-6000	272/6000	272/6000	170/4200
Max. torque, Nm at rpm	250/1500-4500	350/1600-4200	350/1600-4200	350/1600-4200	350/2500-5000	350/2500-5000	350/1750-2500
0-62mph acceleration, seconds	7.4	6.2	6.1	5.8	5.6	5.4	7.7
Top speed, mph	139	151	151	149	155 ²	155 ²	139
CO ₂ emissions ³ , g/km	152	156	168	172	189	184	144
Benefit in kind (BIK)%	20	21	23	24	27	26	21
Fuel consumption ³ , mpg (l/100km) Urban	32.8 (8.6)	31.4 (9.0)	28.2 (10.0)	27.7 (10.2)	25.9 (10.9)	26.2 (10.8)	39.2 (7.2)
Fuel consumption ³ , mpg (l/100km) Extra Urban	53.3 (5.3)	52.3 (5.4)	50.4 (5.6)	49.6 (5.7)	44.1 (6.4)	45.6 (6.2)	62.8 (4.5)
Fuel consumption ³ , mpg (l/100km) Combined	43.5 (6.5)	42.2 (6.7)	39.2 (7.2)	38.2 (7.4)	34.9 (8.1)	35.8 (7.9)	51.4 (5.5)
ABI insurance group 1-50*	32 E	34 E	34 E	34 E	38 E	38 E	32 E
Unladen weight ⁴ , kg	1285	1295	1315	1405	1455	1475	1415
Gross weight limit, kg	1605	1615	1635	1725	1775	1795	1735
Roof/Boot lid load limit, kg	20	20	20	20	20	20	20
Luggage compartment capacity, litres	250	250	250	250	250	250	250
Fuel tank capacity approx, litres	55	55	55	60	60	60	60

*Highest insurance group rating shown. Group may be lower dependent on trim level. Please visit www.thatcham.org/abigrouprating for details.

¹The given values have been determined according to the prescribed measurement process (the latest version of Directive 80/1269/EEC).

²Regulated.

³Fuel consumption and CO₂ emissions figures are obtained under standardised test conditions (Directive 93/116/EEC) using a representative model. This allows direct comparison between different models from different manufacturers, but may not represent the actual fuel consumption achieved in 'real world' driving conditions. More information is available at www.vca.gov.uk.

⁴Vehicle unladen weight without driver (calculated in accordance with the current applicable version of Directive 92/21/EEC). Optional equipment may increase the car's unladen weight and drag coefficient, whereby the possible payload limit and top speed will be correspondingly reduced.

TT Coupé dimensions

The technical drawings opposite show the exact dimensions of the TT Coupé, so you can check everything – from whether the car will fit in your garage to whether your luggage will fit in the boot.

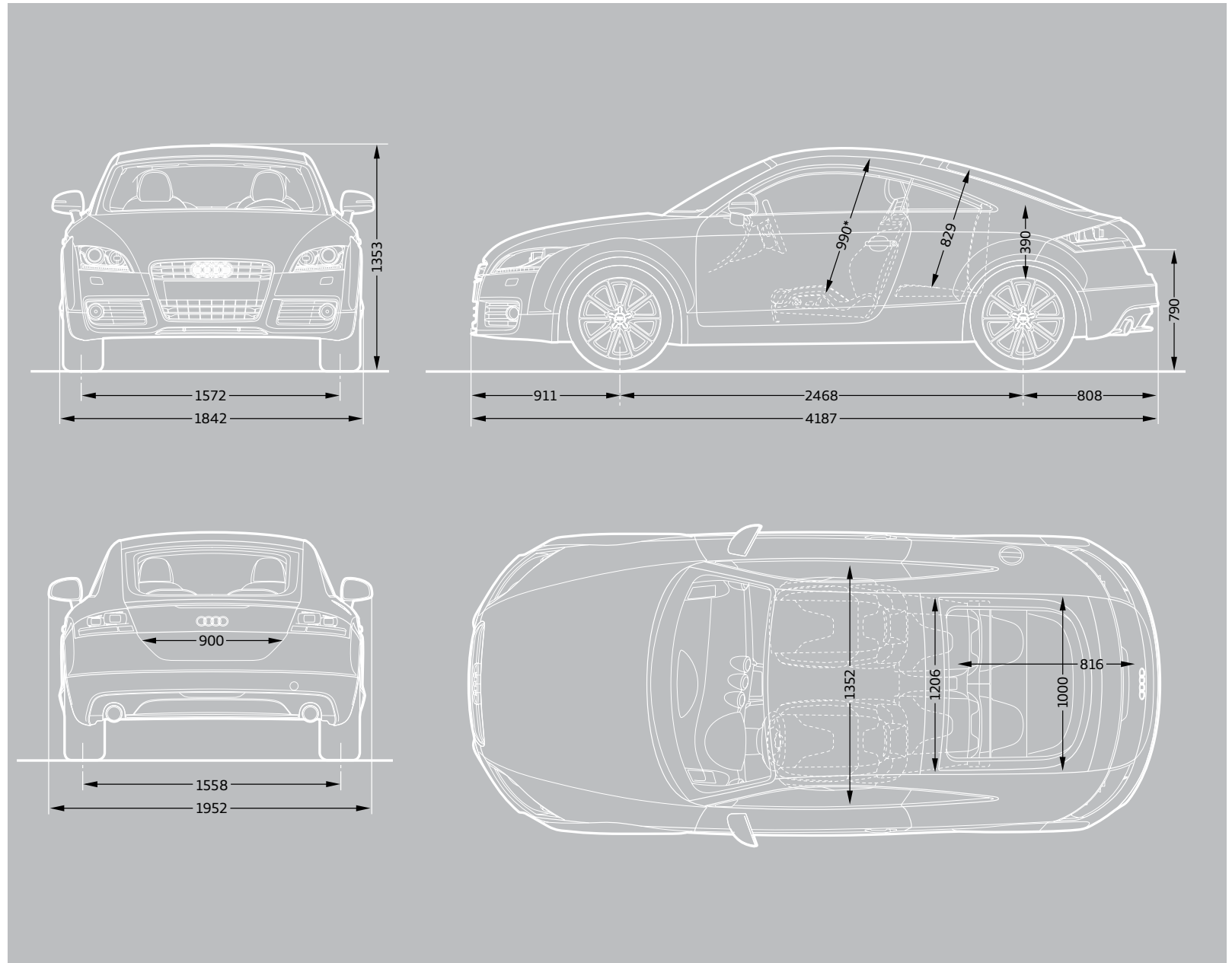

Dimensions were measured at unladen weight. Luggage compartment volume 250/700l (measured in accordance with the VDA method using 200 x 100 x 50 mm blocks; second figure: with rear seat folded down and the vehicle loaded up to roof height). Turning circle approx. 10.9m.

Dimensions in millimetres.

*Maximum headroom.

TT Roadster dimensions

The technical drawings opposite show the exact dimensions of the TT Roadster, so you can check everything – from whether the car will fit in your garage to whether your luggage will fit in the boot.

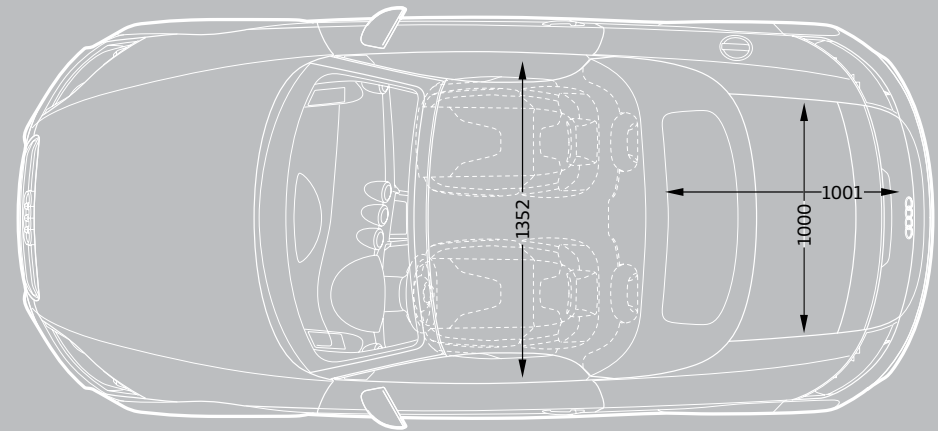
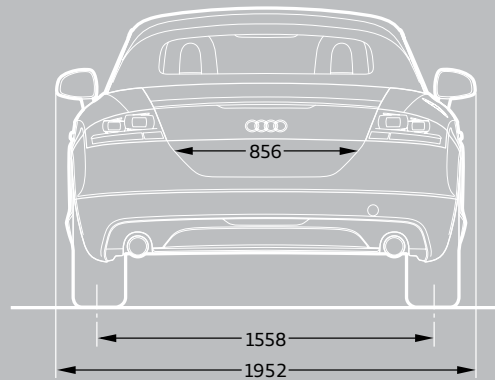
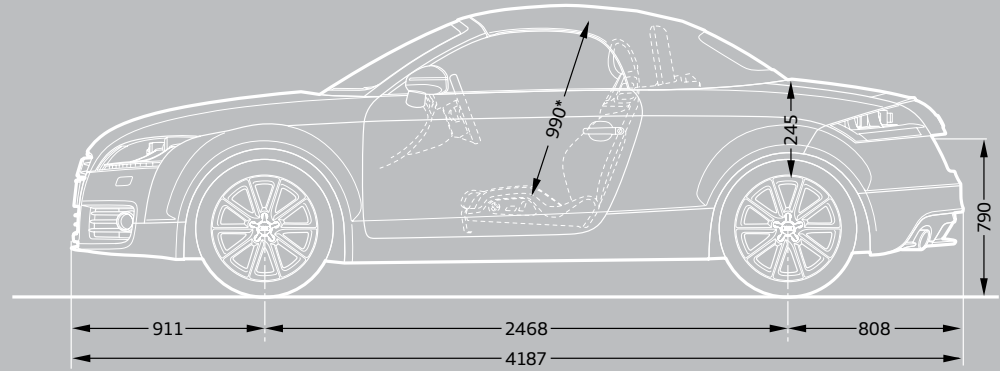
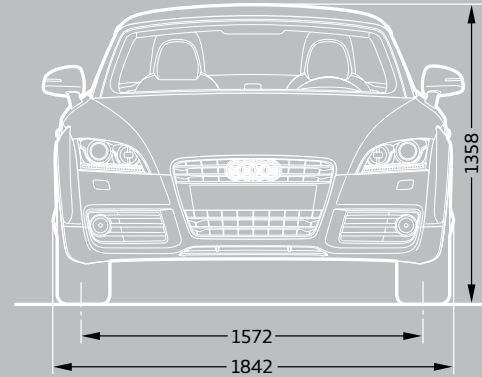

Dimensions were measured at unladen weight. Luggage compartment volume 250/700l (measured in accordance with the VDA method using 200 x 100 x 50 mm blocks; second figure: the vehicle loaded up to roof height). Turning circle approx. 10.9m.

Dimensions in millimetres.

*Maximum headroom.

TTS Coupé dimensions

The technical drawings opposite show the exact dimensions of the TTS Coupé, so you can check everything – from whether the car will fit in your garage to whether your luggage will fit in the boot.

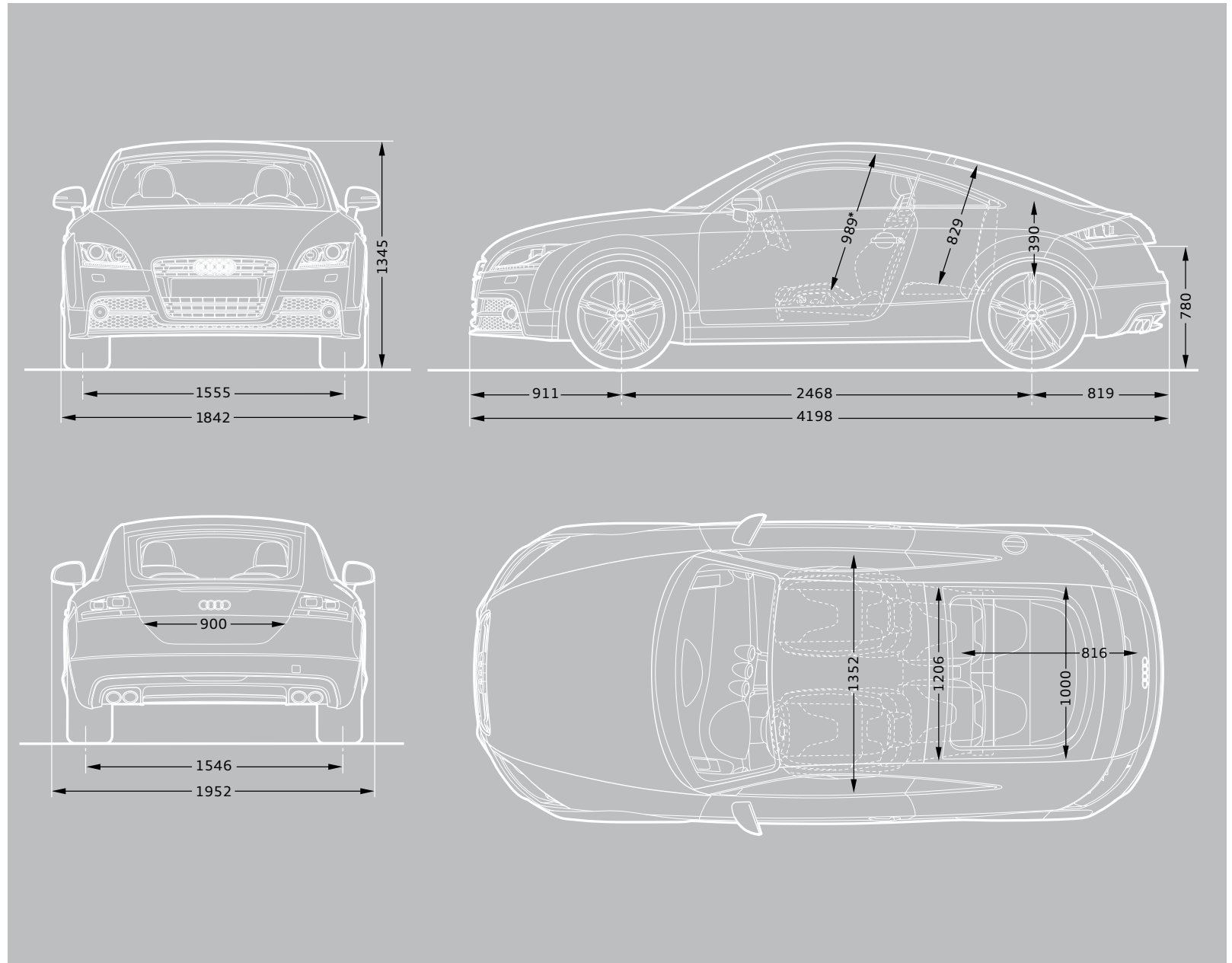

Dimensions were measured at unladen weight. Luggage compartment volume 250/700l (measured in accordance with the VDA method using 200 x 100 x 50 mm blocks; second figure: with rear seat folded down and the vehicle loaded up to roof height). Turning circle approx. 10.9m.

Dimensions in millimetres.

*Maximum headroom.

TTS Roadster dimensions

The technical drawings opposite show the exact dimensions of the TTS Roadster, so you can check everything – from whether the car will fit in your garage to whether your luggage will fit in the boot.

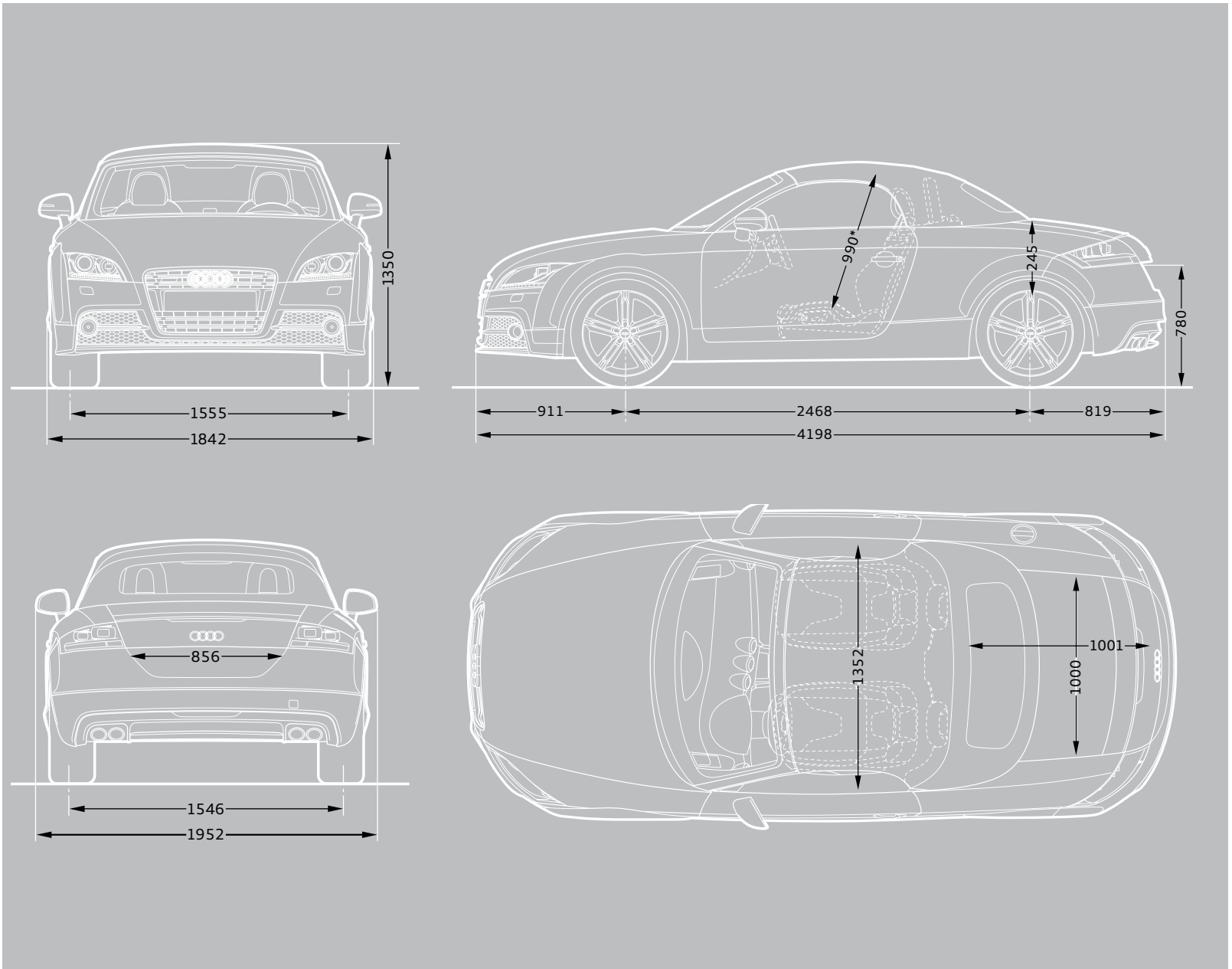

Dimensions were measured at unladen weight. Luggage compartment volume 250/700l (measured in accordance with the VDA method using 200 x 100 x 50 mm blocks; second figure: the vehicle loaded up to roof height). Turning circle approx. 10.9m.

Dimensions in millimetres.

*Maximum headroom.

Additional information

CO₂ data and information

CO₂ emissions-based Vehicle Excise Duty

Vehicle Excise Duty (Road Fund Licence) is based upon the amount of Carbon Dioxide (CO₂) a vehicle emits, measured in grams per kilometre (g/km). First year VED rates apply to the first year of ownership. Annual VED rates apply thereafter. The DVLA has created thirteen categories:

Petrol and Diesel engines	First year	Annual rate (second year onwards)
A – up to 100g/km	£0.00	£0.00
B – 101 to 110g/km	£0.00	£20.00
C – 111 to 120g/km	£0.00	£30.00
D – 121 to 130g/km	£0.00	£95.00
E – 131 to 140g/km	£115.00	£115.00
F – 141 to 150g/km	£130.00	£130.00
G – 151 to 165g/km	£165.00	£165.00
H – 166 to 175g/km	£265.00	£190.00
I – 176 to 185g/km	£315.00	£210.00
J – 186 to 200g/km	£445.00	£245.00
K – 201 to 225g/km	£580.00	£260.00
L – 226 to 255g/km	£790.00	£445.00
M – over 255g/km	£1,000.00	£460.00

Vehicle Excise Duty (VED) rates correct at time of going to print, but these may alter to reflect any change in the applicable VED rate

Servicing tailored to your needs

Regular servicing is key to safeguarding your Audi's performance and a full Audi service history could help you preserve the future resale value. To make servicing easy, the Audi Service Schedules have been designed to work with your individual driving style and vehicle.

There are two schedules available and your Audi Centre will advise which schedule is most suited to your needs. The conventional fixed Audi Inspection Service Schedule has fixed intervals for the Oil-change and Inspection Service that are based on time and distance, whichever comes first.

With the Audi LongLife Service Schedule, sensors take account of driving style and conditions in which the vehicle is used to indicate when the Oil-change Service is required. Oil-change Service intervals are therefore variable and are conveniently indicated via the on-board service interval display.

Audi Complete

When selecting the option of Audi Complete your vehicle should be placed on the following service schedules dependent on your mileage per annum:

- ▶ Under 10,000 miles per annum – Fixed Inspection Service Schedule
- ▶ Over 10,000 miles per annum – LongLife Service Schedule

Fixed Inspection Service Schedule

	Vehicle usage:
Mileage	Less than 10,000 miles per annum
Type of journey	Mainly city/town centre driving. Short journeys
Conditions	Frequent cold starts. High engine loading – e.g. frequent hill climbs, vehicle fully loaded, towing
Driving style	Uneconomical – e.g. heavy acceleration, heavy braking, constant changes in speed, constant use of high revs, 'sporty' driving
	Service Intervals:
Oil-change Service	Fixed to every 9,000* miles/1 year
Inspection Service	Fixed to every 19,000* miles/2 years

Variable LongLife Service Schedule

	Vehicle usage:
Mileage	More than 10,000 miles per annum
Type of journey	Motorway and main road driving. Mainly longer distance journeys. Constant speeds
Conditions	Normal engine loading – e.g. with little or no towing, with little or no hill climbs. Normal vehicle loading
Driving style	Moderate acceleration, moderate braking, engine revs mainly below 3,000
	Service Intervals:
Oil-change Service	Variable to a maximum of every 19,000* miles/2 years
Inspection Service	Fixed to every 19,000* miles/2 years

*As indicated by the service interval display. Mileages are approximate as the Service Indicator system uses kilometres as its distance measurement.

Additional information

Welcome to Audi

By placing an order for your Audi, you're choosing to get behind the wheel of one of the most sophisticated cars on the road. And because we believe the service we offer should be just as advanced, we wanted to let you know exactly what you can expect from us, now and in the future.

We've agreed a set of standards with all our Centres, which governs the way we do business with you. It outlines the kind of service we promise to deliver for every customer, right down to filling each new Audi we sell with half a tank of fuel.

So whether you're interested in the date your car will arrive in the UK or the way we'll dispose of non-biodegradable materials after we service your Audi, you can have total confidence in us.

Audi Promise

Audi Centres

We guarantee that all our Centres will be open as follows:

Sales: Monday to Friday 9am–6pm
Saturday 9am–5pm

Service: Monday to Friday 8am–6pm
Saturday 8.30am–1pm

Sunday opening is at local discretion.

New car delivery

Once we've confirmed a delivery date for your car, we'll keep you informed of progress. Subject to reasonable notice, we'll then deliver it to a place of your choice, whether that's your home or work. In the unlikely event of a delay, we'll provide a courtesy car to minimise inconvenience and keep you mobile.

The experts in Vorsprung durch Technik

Would you entrust your Audi to anyone who hasn't been regularly trained to Audi standards? Our Audi Approved Master Technicians have undergone an impressive 100,000 hours of training over a 10-year programme to ensure they have the latest technical expertise for maintaining and servicing your Audi. All our Service Advisors undergo a specialist induction and training to ensure they are Audi professionals and able to talk to you about any issues you may have with your Audi vehicle. What's more, we have so much expertise and experience in looking after Audi vehicles that we are able to make a note of your mileage and the state of your vehicle as and when we see it and predict when certain key events may occur. As part of our commitment to you, we will notify you in plenty of time so you can make an appointment with us.

Your convenience comes first

At Audi you can choose from a range of convenient services that suit your needs. Why not book a 'service while you wait' appointment* and enjoy our complimentary refreshments while your car is with us? Or, if you need to be mobile, take advantage of one of our courtesy cars which we can even collect and deliver to you.*

We guarantee we can service your Audi within 5 days without a courtesy car, or within 10 days if you need transport. We will also ensure your car is returned to you with a full valet.

Audi Genuine Parts

Would you put a part into your Audi that wasn't the same quality as the factory fitted original? You can rest assured that only Audi Genuine Parts will be used on your vehicle. What's more, Audi parts and labour come with a 2-year guarantee.** We stock a wide variety of parts, so we are well covered. However, if we don't have a part in stock at our Centre we have the back-up of parts at other Audi Centres, at our national warehouse and our factory and can usually source the relevant part very quickly.

We don't like surprises either

We believe strongly in transparency and there will be no hidden costs. For added peace of mind, we will give you a quotation over the phone for the work you have requested and email you the price confirmation. We'll consult you if any additional work on your car is needed when it is with us. We won't carry out any extra work without asking your permission first.

The Audi Stamp

Regular servicing is key to safeguarding your Audi's performance and a full Audi service history could help you preserve the future re-sale value of your car. Only the Audi Stamp will prove your approved Audi service history.

Getting better every time

We continually gather feedback from our Audi Trained Technicians, as well as our customers, to ensure our vehicles are running as they should. Whenever we see an Audi for a service, we connect it directly to our headquarters in Ingolstadt which enables us to check your car's software and make sure it's as up-to-date as possible. If the factory has released a software upgrade for your model, it can be applied immediately – improving anything from your car's efficiency to the precision of its parking system.

Environmental commitment

We promise to dispose of all non-biodegradable materials from your vehicle in a responsible manner

*Subject to availability.

**Excludes wear and tear.

Pricing information

Pricing

Prices and specifications given are correct at the time of printing. Always check details with your Audi Centre, as Audi policies are continually developing. We reserve the right to change prices or specifications at any time.

All prices are subject to VAT, currently charged at 20% but this may alter to reflect any change in the applicable VAT rate.

Delivery charges and number plates are not included in the vehicle price.

Delivery charge	£471.66
Number plate	£20.00
VAT	£98.34
Total	£590.00

Audi Roadside Assistance

Your new car comes complete with 3 years' complimentary roadside assistance and recovery across the UK provided by RAC Motoring Services. Also included is roadside assistance throughout Europe, managed by RAC Motoring Services.

For further information and terms and conditions please visit audi.co.uk

Audi Customer Care

Every new Audi benefits from the comprehensive Audi Customer Care Package, which comprises:

- ▶ A 3-year Audi warranty, which covers you for unlimited mileage in the first 2 years of ownership, with a full mechanical and electrical warranty which covers you for up to 60,000 miles in the 3rd year

- ▶ A 3-year paint warranty
- ▶ A 12-year anti-corrosion warranty
- ▶ 3 years' UK roadside assistance and recovery

You also have the option when ordering your new car of choosing a 4-year or 5-year Audi warranty. Speak to a member of the sales team for more information.

Audi Tax-Free Sales

If you are entitled to purchase a vehicle free of VAT, normally through Military or Diplomatic privilege, please contact your local Audi Centre for full details.

Should you have any difficulty obtaining the information you require, please call Freephone 0800 585878.

Audi Finance

Audi Finance specialise in providing funding solutions for Audi drivers. Whether your Audi is for private or business use, there are a range of funding options to choose from.

Below is the full range of finance products.

- ▶ Solutions – a Personal Contract Plan
- ▶ Hire purchase
- ▶ Lease purchase
- ▶ Finance lease
- ▶ Contract hire

With all products, you can choose a fixed-cost maintenance plan designed to help you budget accurately.

No matter what Audi model you choose, your local Audi Centre can provide you with a personalised quote which could fit your budget and motoring needs.

Audi Finance is a trading name of Volkswagen Financial Services (UK) Limited. An offer of finance depends on certain conditions. Available to people over 18 in the UK only.

Audi Insurance

We want you to start enjoying your new car from day one and thanks to Audi Insurance complimentary seven day cover, you can. Call free on 0800 316 7893 (lines are open Monday to Friday 8am - 9pm, and Saturday 9am - 5pm), provide a few details and a cover note will be sent to your Audi Centre. They will then tax your car and you can drive it away.

Audi Insurance is a trading name of Volkswagen Insurance Service (Great Britain) Limited, an appointed representative of Volkswagen Financial Services (UK) Limited, Brunswick Court, Yeomans Drive, Blakelands, Milton Keynes MK14 5LR. Registered in England number 2835230. Audi Insurance is sold, underwritten and administered by Allianz Insurance plc registered in England number 84638. Registered office 57 Ladymead, Guildford, Surrey GU1 1DB. Volkswagen Financial Services (UK) Limited and Allianz Insurance plc are authorised and regulated by the Financial Services Authority. Volkswagen Financial Services (UK) Limited and Allianz Insurance plc are not part of the same corporate group.

Audi UK

Customer Services
Selectapost 29
Sheffield
S97 3FG
0800 699888
audi.co.uk

Specifications and prices subject
to change without notice.

© Audi (UK)

Printed in the UK
Edition 6.3 08/11
2012 model year

Images are for illustrative purposes only.