



The Audi A5 and S5 Cabriolet
Pricing and Specification Guide
Valid from June 2012

Personalising your Audi A5 Cabriolet

This guide has been designed to help you tailor and price your Audi A5 Cabriolet quickly and logically. At the back, you will find information on CO2 emissions-based taxation and the other services offered by Audi, including Finance and Insurance. You can also configure your Audi A5 Cabriolet online at audi.co.uk.

You might also like to consider Audi Complete: a simple way to take care of servicing and maintenance costs for your Audi in a single package. You pay a one-off or monthly fee and we'll cover all your servicing, maintenance and tyres for the next three years including a full 5-year warranty. It means you only have to pay for fuel, insurance and your Road Fund Licence. So you can be reassured that your car will be maintained by trained Audi Technicians, using genuine Audi parts.

Audi Complete™

The Audi A5 Cabriolet

Efficiency	8
Engines	10
Transmissions	11
quattro®	12

Model details and prices

Standard model equipment	14
SE model equipment	16
S line model equipment	17
S5 Cabriolet model equipment	18
Model prices	20

Audi exclusive

Colour and upholstery

Paint and hoods	24
Upholstery and seats	26
Colour and trim guide	36
Inlays	40

Options

Wheels, tyres and suspension	42
Packages	44
Audio and communication	46
Interior equipment	48
Exterior equipment	50
Safety and security	51
Steering wheels	52
Audi Complete and warranty	53
Merchandise	54
Accessories	55

Technical details

Technical data	56
Dimensions	59
Additional information	61
Pricing information	63





Vorsprung durch Technik

Three words that express the very essence of Audi. Vorsprung durch Technik isn't a slogan. It's our way of seeing the world. It is the driving force behind our history of innovation that continues into the 21st century. Indeed, many technologies that Audi pioneered remain in our cars today. Some are milestones in the history of the motorcar.

From our beginnings in 1899 to the Auto Union team's Grand Prix successes in the 1930s and our more recent wins at Le Mans, we have always been at the forefront of the motor industry.

Vorsprung durch Technik makes us who we are. To see more of its influence, just read on.

The Audi A5 Cabriolet: with technology that makes it ideal for all conditions

Great design tends to get noticed. The shape of the Audi A5 Cabriolet, for example, has probably already caught your attention. But there's another kind of beautiful design in this car that's just as significant: the technology. We've included a fully automatic hood as standard, enabling you to make the most of the sun. There's also optional head-level heating for when it's cold and heat-resistant upholstery for when it's hot. So now there really is no bad weather.





Efficiency

At Audi, doing less is something we're trying to do more of. We're working to use less fuel, release less CO₂ and waste less energy. It's why we've incorporated a number of more efficient technologies into the Audi A5 Cabriolet.

Automatic Start-Stop function

In heavy traffic, your car still uses fuel and releases CO₂, even when it's stationary. The automatic Start-Stop function counteracts this problem by switching off the engine when your car comes to a standstill. As soon as you touch the clutch, the car restarts. In conjunction with TDI® and TFSI®, it helps save up to 0.4 litres of fuel every 100km.

TDI® and TFSI®

Inside the engine of the Audi A5 Cabriolet you'll find the same advanced fuel-injection technology that's driven us to win after win at Le Mans. With TDI® and TFSI®, fuel is injected directly into the engine's chambers so that combustion is timed right down to the millisecond. As a result, waste is minimised and you get the most from every last drop of fuel.





Recuperation

When a vehicle brakes, the discs convert the kinetic energy into thermal energy, which is wasted as it cannot be used. With a recuperation system like the one in the Audi A5 Cabriolet, the kinetic energy is converted into useful electrical energy. The way it works is simple. While the car is coasting or braking, the alternator voltage is raised above the level of the basic electrical system, which enables the alternator to generate electrical energy and store it temporarily in the battery. When the vehicle accelerates, this energy is used to relieve the load on the alternator, resulting in a fuel saving of up to 3%.

Engines

Petrol

TFSI® direct-injection technology is a unique Audi innovation that includes supercharging, which combines FSI® technology with forced induction – giving cars an extra injection of power and torque. It also delivers enhanced fuel efficiency as precisely the right amount of fuel and air are injected into the combustion chambers, enabling the engine to ‘breathe’ more easily. It results in reduced heat loss and increased output, with around a 15% reduction in fuel consumption and significantly lower exhaust emissions.

Diesel

We introduced TDI® to the roads in 1989, marking a departure from the noisy, fuel-thirsty diesel engines of the past. And since then, we’ve continuously refined it, recently developing commonrail technology. Under this system, a series of piezo injectors use electrical charge to precisely control the amount of fuel injected into the engine. As well as reducing noise, this allows combustion to happen at a lower temperature, with less oxygen, which lowers emissions.





Transmissions

multitronic®

Translating a driver's preferences and intentions into road performance, the multitronic® transmission system entertains no compromises – whether in terms of dynamism, convenience or economy. multitronic® automatic transmission is available on models without quattro® permanent all-wheel-drive. A continuously variable transmission, multitronic® can transmit up to 400 Nm of torque and permits an exceptionally wide range of gear ratios. The result is smooth, powerful acceleration and a high level of driving comfort. And thanks to its lightweight design and a number of advanced electronic control systems that monitor gradient, road conditions and the way the driver is using the accelerator pedal, multitronic® also plays an instrumental role in reducing fuel consumption.

S tronic®

Driving is all about thinking ahead, which is just what the S tronic® dual-clutch transmission does. It works almost as two separate systems, one engaging the odd-numbered and the other the even-numbered gears. So when you're accelerating in second, it has third gear waiting for you. And once you make the switch, it's already thinking about fourth. With two clutches working together, you can change gears almost instantly while experiencing smooth, uninterrupted power.

quattro®

It's the technology that has given Audi the edge on the rally circuit ever since it was first introduced over 30 years ago – a technology that delivers ultimate control whilst enhancing the sporty characteristics which make the Audi A5 Cabriolet so thrilling to drive. It's called quattro® permanent all-wheel-drive. The principle is simple: in the same way that four brakes ensure better deceleration, four permanently-driven wheels deliver better acceleration and road-holding, pushing or pulling the car as needed, for a driving experience that's both dynamic and safe.

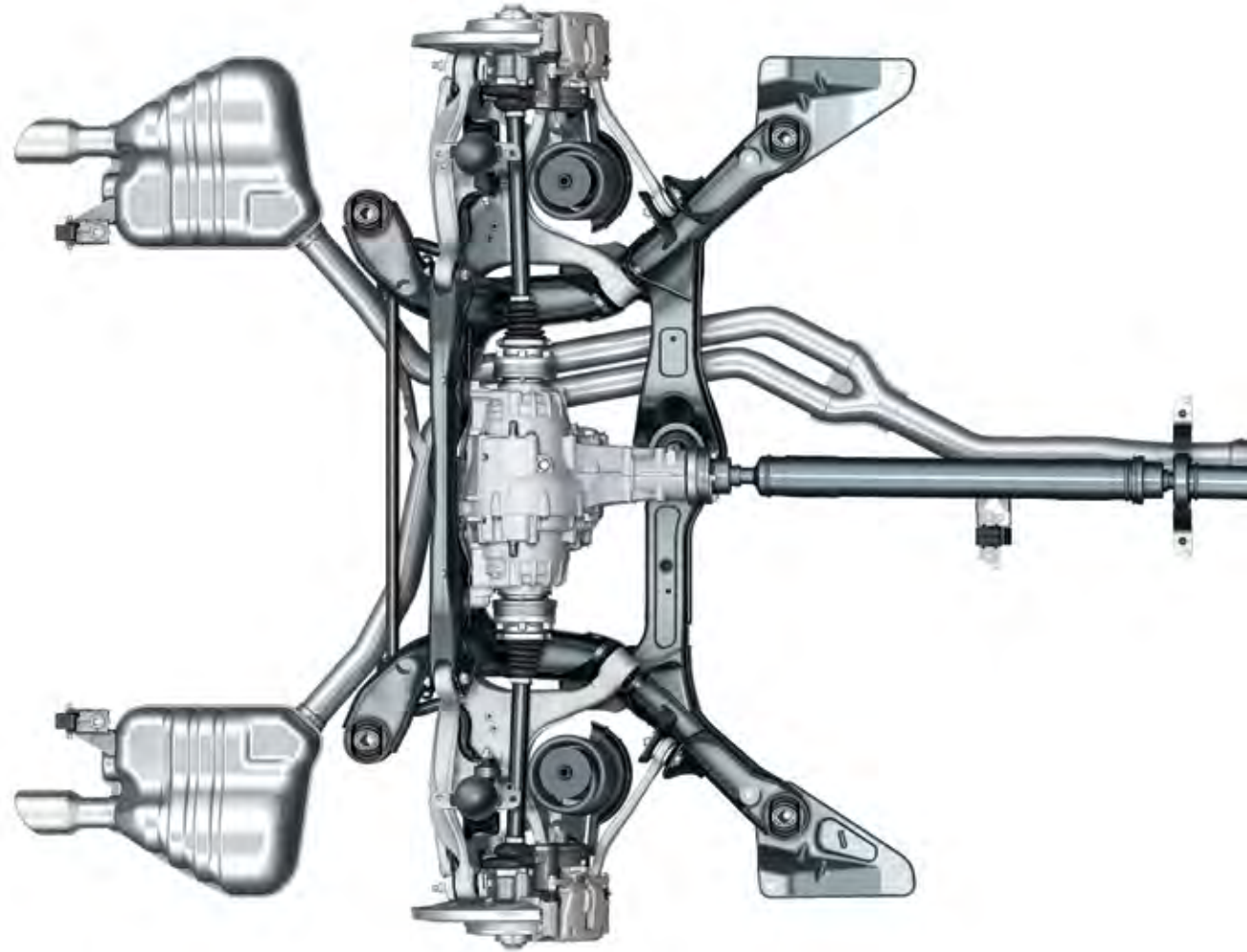

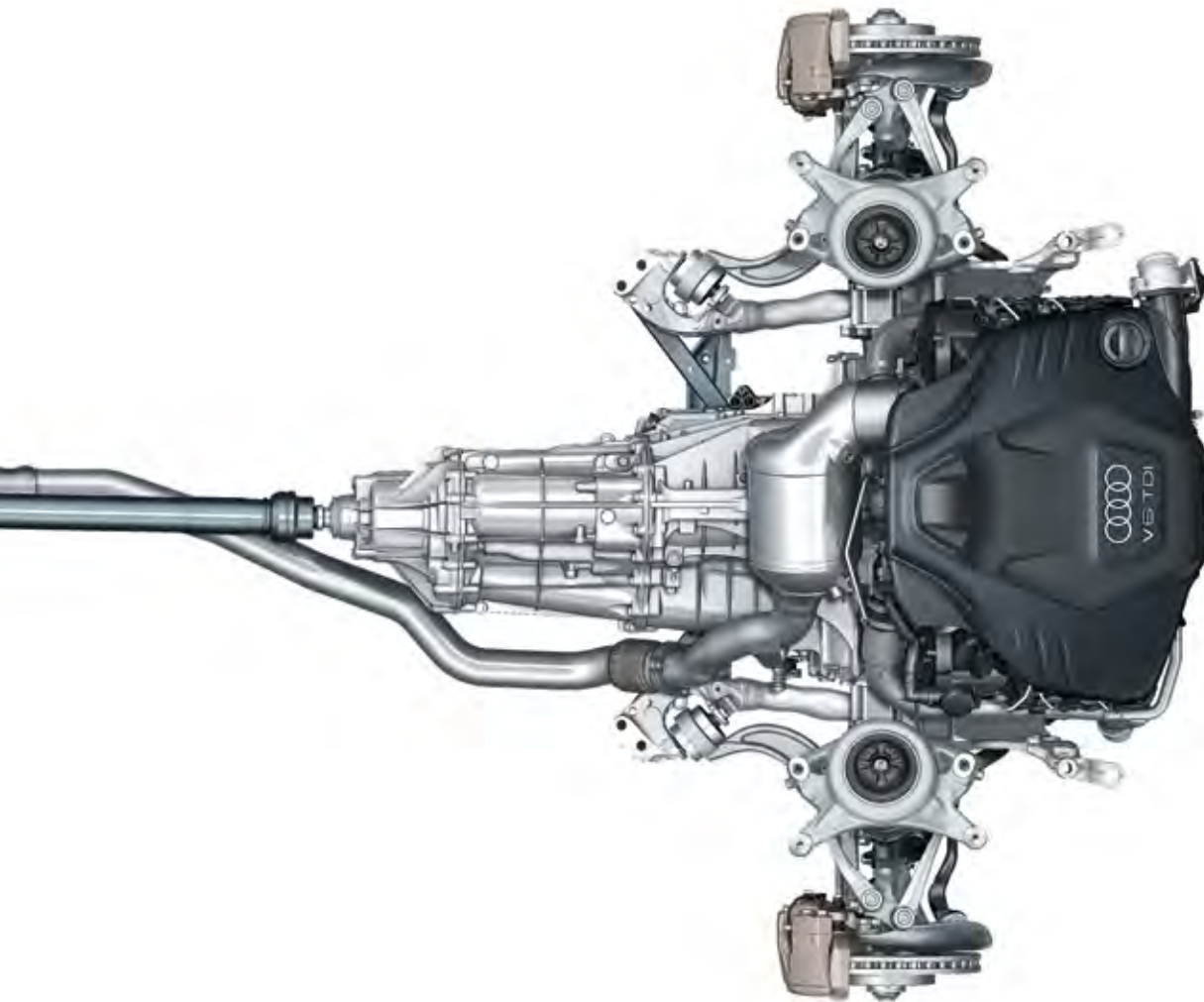

In the Audi A5 Cabriolet, asymmetric dynamic torque distribution continuously distributes drive power between the front and rear axles, depending on weather conditions, road surface and gradient. This leads to greater flexibility and an enhanced, sportier drive.

quattro® with Sports differential

The optional electronically regulated Sports differential distributes variable amounts of drive force to each rear wheel, ensuring outstanding acceleration performance in corners and stabilising the vehicle's response to load change. It also brings better direct steering characteristics and, as it requires less steering effort, more agile handling.

Standard model equipment

All Audi A5 Cabriolet models have the following items of standard equipment

Engines

Automatic Start-Stop function for greater fuel and CO₂ efficiency

Recuperation for optimal energy utilisation

Misfuelling inhibition for diesel engines

Diesel particulate filter (DPF) for diesel engines

Wheels, tyres and suspension

17" x 7.5J '6-arm' design alloy wheels with 225/50 R17 tyres

Locking wheel bolts

Space-saver spare wheel

Audio and communication

Audi Concert radio which includes:

- Single CD drive and SDHC memory card reader which are both MP3, WMA and AAC compatible
- 6.5" colour centre display with MMI operating logic
- AUX-IN connection
- TP memo - automatically saves traffic news when driving

8 speakers (80 Watts)

Safety and security

Electronic Stability Programme (ESP) including electronic limited-slip differential on front-wheel-drive models

Rest recommendation system - analyses driving behaviour based on steering, pedals and gear lever movements. If the system detects a change in driving patterns it can, via audio and visual effects, notify the driver of the possible need to take a rest

First aid kit

Front and rear fog lights

Front and rear ISOFIX preparation with front passenger airbag de-activation switch

Full size airbags for driver and passenger

Front side airbags

Halogen headlights with electric headlight range control and daytime running lights

Thatcham category 1 alarm and immobiliser

Toolkit and car jack

Warning triangle

Seats

Arcade cloth upholstery

Split-folding rear seat

Interior equipment

1-zone climate control

3-spoke leather steering wheel

Driver's Information System (DIS) with energy saving tips and gearshift indicator

Electric front and rear windows

Electromechanical parking brake includes parking brake function when stationary, drive-off assistance function through automatic release when driving away and emergency braking function whilst driving, acting on all 4 wheels

Front and rear floor mats

Intelligent key

Interior chrome package

Reflex finish inlays (Steel grey for grey or black interiors, Moor brown for beige interiors)

Steering column adjustment for rake and reach

Electromechanical power steering

Cup holder in centre console



17" x 7.5J '6-arm' design alloy wheels



Fully automatic hood



Audi Concert radio



Exterior mirrors - electrically operated and heated

Exterior equipment

Fully automatic hood (can be operated at speeds up to 31mph)

Exterior mirrors – electrically operated and heated

Exhaust pipes – 4-cylinder diesel models have two exhaust pipes on the left-hand side, all others have one exhaust pipe on either side

Exterior aluminium package

Front grille in high gloss black



SE model equipment

In addition to Standard model equipment

Basic RRP
£1,608.33

Total RRP inc VAT
£1,930.00

Wheels, tyres and suspension

17" x 7.5J '5-arm' design alloy wheels with 225/50 R17 tyres

Audio and communication

Audi sound system speaker package with 10 speakers including subwoofer (180 Watts)

Mobile telephone preparation – Bluetooth interface

Seats

Milano leather upholstery

Safety and security

Light and rain sensor – automatically switches the dipped beam headlights and windscreen wipers on/off depending on the light and rain conditions. Also includes coming home/leaving home function which delays the deactivation of the front and rear lights after locking and automatic activation of the lights when unlocking

Rear parking sensors – facilitate parking by acoustically indicating the distance to obstacles; measurement is by ultrasonic sensors integrated discreetly into the bumper

Interior equipment

3-spoke multi-function leather steering wheel (paddle shift for automatic models)

Deluxe 3-zone climate control with separate air distribution and digital display for driver and front passenger. System includes air-conditioning controls in rear centre console for rear passenger compartment

Driver's Information System (DIS) in colour with energy-saving tips and rest recommendations. Shows the radio station or track title, telephone control, menu and other display information from the infotainment system such as navigation (if fitted). Also includes an on-board trip computer with short and long-term trip memory, outside temperature display, digital speedometer and door or boot open warning

Front centre armrest including 12V power socket

Wind deflector



17" x 7.5J '5-arm' design alloy wheels



Rear parking sensors

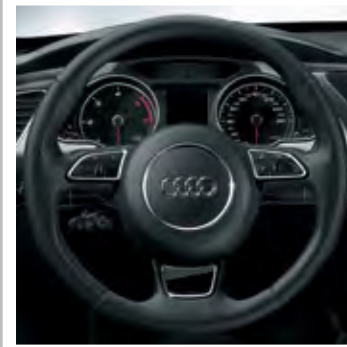

3-spoke multi-function leather steering wheel



Deluxe 3-zone climate control

S line model equipment

In addition to SE model equipment

Basic RRP
£2,133.33

Total RRP inc VAT
£2,560.00

Wheels, tyres and suspension

18" x 8J '5-spoke' design alloy wheels with 245/40 R18 tyres

Sports suspension with stiffer spring settings and shock absorbers, 20mm lower than standard suspension. (S line Sports suspension available at no charge)

Interior equipment

3-spoke S line multi-function steering wheel (paddle shift for automatic models)

Matt-brushed aluminium inlays

Perforated leather gear knob

S line sill plates

Seats

Front Sports seats with electric lumbar support

Fine Nappa leather with S line embossing

Exterior equipment

Acoustic hood with LED passenger reading lights

Chrome rolled exhaust

S line exterior styling package including:

- S line side skirts

- S line bumper

- S line rear diffuser

- S line badges on wings

Xenon plus headlights with LED daytime running lights

Rear LED lights



18" x 8J '5-spoke' design alloy wheels



3-spoke S line multi-function steering wheel

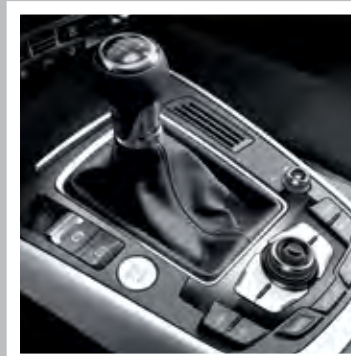

Perforated leather gear knob



Xenon plus headlights with LED daytime running lights



S5 quattro Cabriolet model equipment – in addition to SE model equipment

The Audi S5 Cabriolet features a powerful 3-litre V6 engine as standard, which uses supercharging to take you from 0 to 62 mph in just 5.4 seconds. From the comfort and stability of an S5-embossed Fine Nappa leather Super Sports seat, you can sit back and enjoy every unit of this engine's 333PS capability, not to mention the safety and security of quattro permanent-all-wheel-drive.

Wheels, tyres and suspension

19" x 8.5J '5-parallel-spoke' design alloy wheels with 255/35 R19 tyres

'S' Sports suspension

Interior equipment

3-spoke 'S' Sports multi-function leather steering wheel with contrasting stitching

Aluminium scuff plates with S5 logo

Interior light package

Inlays in matt-brushed aluminium

'S' instrument dials

Safety and security

'S' model enhanced braking system

Seats

S5 Super Sports seats with electric adjustment and lumbar support

Fine Nappa leather upholstery

Exterior equipment

Acoustic hood with LED passenger reading lights

Aluminium-effect door mirror housings

Exhaust pipes – twin on left and right-hand side in chrome rolled finish

'S' radiator grille with S5 logo

Painted brake callipers with S5 logo

'S' body styling

Xenon plus headlights with LED daytime running lights and LED rear lights



19" x 8.5J '5-parallel-spoke' design alloy wheels



'S' instrument dials

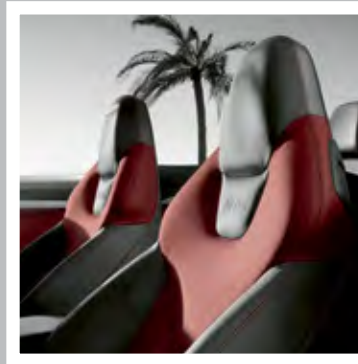

S5 Super Sports seats with electric adjustment and lumbar support



'S' radiator grille with S5 logo



A5 Cabriolet Standard

Engines	Power	Transmissions	CO ₂ g/km	Basic RRP	Total RRP inc VAT	Recommended OTR
1.8 TFSI	170PS	6-speed manual	143	£23,895.83	£28,675.00	£29,455.00
1.8 TFSI	170PS	multitronic	143	£25,129.17	£30,155.00	£30,935.00
2.0 TFSI	211PS	6-speed manual	154	£26,312.50	£31,575.00	£32,390.00
2.0 TFSI	211PS	multitronic	149	£27,545.83	£33,055.00	£33,835.00
2.0 TFSI quattro	211PS	7-speed S tronic	164	£28,816.67	£34,580.00	£35,395.00
2.0 TDI	143PS	6-speed manual	126	£25,475.00	£30,570.00	£31,215.00
2.0 TDI	177PS	6-speed manual	127	£25,895.83	£31,075.00	£31,720.00
2.0 TDI	177PS	multitronic	132	£27,129.17	£32,555.00	£33,320.00
2.0 TDI quattro	177PS	6-speed manual	142	£27,166.67	£32,600.00	£33,380.00

A5 Cabriolet SE

Engines	Power	Transmissions	CO ₂ g/km	Basic RRP	Total RRP inc VAT	Recommended OTR
1.8 TFSI	170PS	6-speed manual	143	£25,504.17	£30,605.00	£31,385.00
1.8 TFSI	170PS	multitronic	143	£26,737.50	£32,085.00	£32,865.00
2.0 TFSI	211PS	6-speed manual	154	£27,920.83	£33,505.00	£34,320.00
2.0 TFSI	211PS	multitronic	149	£29,154.17	£34,985.00	£35,765.00
2.0 TFSI quattro	211PS	7-speed S tronic	164	£30,425.00	£36,510.00	£37,325.00
2.0 TDI	143PS	6-speed manual	126	£27,083.33	£32,500.00	£33,145.00
2.0 TDI	177PS	6-speed manual	127	£27,504.17	£33,005.00	£33,650.00
2.0 TDI	177PS	multitronic	132	£28,737.50	£34,485.00	£35,250.00
2.0 TDI quattro	177PS	6-speed manual	142	£28,775.00	£34,530.00	£35,310.00
3.0 TDI	204PS	multitronic	138	£30,504.17	£36,605.00	£37,370.00
3.0 TDI quattro	245PS	7-speed S tronic	154	£33,320.83	£39,985.00	£40,800.00

A5 Cabriolet S line

Engines	Power	Transmissions	CO ₂ g/km	Basic RRP	Total RRP inc VAT	Recommended OTR
1.8 TFSI	170PS	6-speed manual	143	£27,637.50	£33,165.00	£33,945.00
1.8 TFSI	170PS	multitronic	143	£28,870.83	£34,645.00	£35,425.00
2.0 TFSI	211PS	6-speed manual	154	£30,054.17	£36,065.00	£36,880.00
2.0 TFSI	211PS	multitronic	149	£31,287.50	£37,545.00	£38,325.00
2.0 TFSI quattro	211PS	7-speed S tronic	164	£32,558.33	£39,070.00	£39,885.00
3.0 TFSI quattro	272PS	7-speed S tronic	199	£35,470.83	£42,565.00	£43,670.00
2.0 TDI	143PS	6-speed manual	126	£29,216.67	£35,060.00	£35,705.00
2.0 TDI	177PS	6-speed manual	127	£29,637.50	£35,565.00	£36,210.00
2.0 TDI	177PS	multitronic	132	£30,870.83	£37,045.00	£37,810.00
2.0 TDI quattro	177PS	6-speed manual	142	£30,908.33	£37,090.00	£37,870.00
3.0 TDI	204PS	multitronic	138	£32,637.50	£39,165.00	£39,930.00
3.0 TDI quattro	245PS	7-speed S tronic	154	£35,454.17	£42,545.00	£43,360.00

S5 Cabriolet

Engine	Power	Transmission	CO ₂ g/km	Basic RRP	Total RRP inc VAT	Recommended OTR
S5 Cabriolet	333PS	7-speed S tronic	199	£37,337.50	£44,805.00	£45,910.00

Please note: The maximum power output figures are quoted in PS (or Pferdestärke, which is the metric equivalent of brake horsepower). To convert to brake horsepower, divide the PS figure by 1.0139.

Recommended On-The-Road (OTR) retail prices include: delivery charge, half a tank of fuel, number plates at £590.00 (inc. VAT), Road Fund Licence (which may vary depending on model/transmission – see page 61 for details) and first registration fee at £55.00. Vehicle Excise Duty correct at time of going to print, but this may alter to reflect any change in the applicable VED rate.

RRP – Recommended Retail Price. VAT is calculated at 20% but this may alter to reflect any change in the applicable VAT rate.



Audi exclusive



Every Audi is intrinsically exclusive. It's the breathtaking design, the exceptional engineering, the Vorsprung durch Technik. But for that special touch you can specify your A5 Cabriolet with options from Audi exclusive. Whether you want a unique, custom-mixed paint colour or seats in a combination of complementary shades, Audi exclusive will enable you to drive the car you've always imagined.

Both the exclusive and standard options can be found on the following pages.

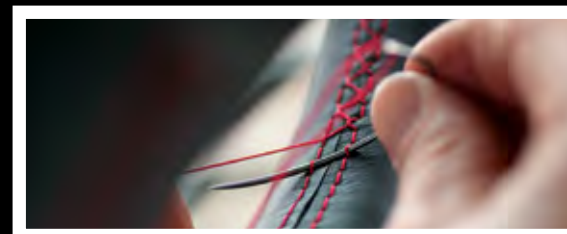
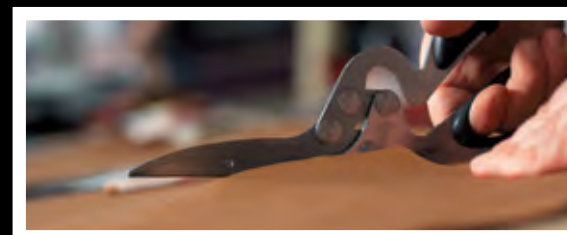
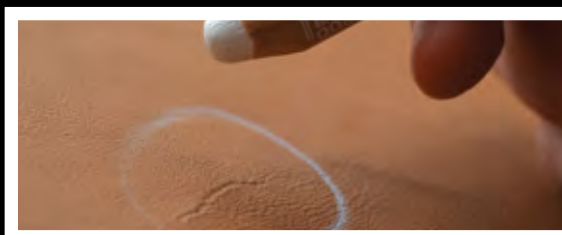

Paint and hoods

You can select one of the Standard colours shown opposite or, for a different look, choose from a range of optional finishes.

Options are subject to availability and may extend delivery.

All the colour swatches on this page are matched as accurately as possible to the actual paint colours used. However, due to print processes, Audi UK cannot guarantee that colours shown are 100% accurate.

Visit your local Audi Centre for a more accurate colour swatch.

*Not available on S5 quattro

RRP - Recommended Retail Price.

VAT is calculated at 20% but this may alter to reflect any change in the applicable VAT rate.

Standard colours



Ibis white - T9

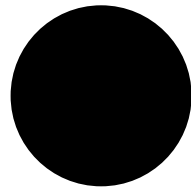

Brilliant black - A2

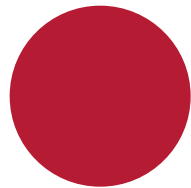

Brilliant red - C8

Optional colours

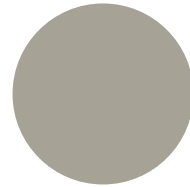

Cuvee silver, metallic* - 0D

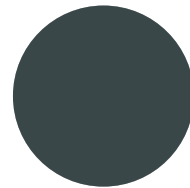

Monsoon grey, metallic - 0C

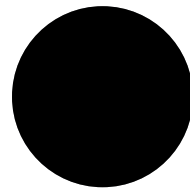

Lava grey, pearl effect - 1R



Glacier white, metallic - 2Y

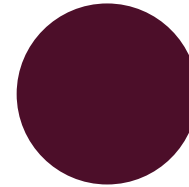

Shiraz red, metallic* - 3A

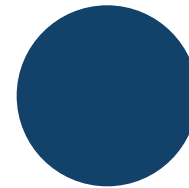

Scuba blue, metallic* - 59

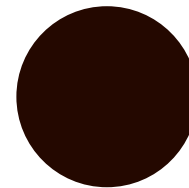

Teak brown, metallic* - 4U

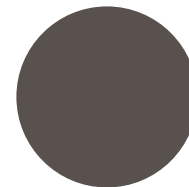

Dakota grey, metallic* - Y7

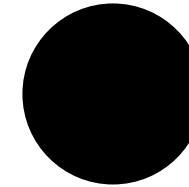

Phantom black, pearl effect - L8

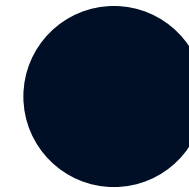

Moonlight blue, metallic - W1

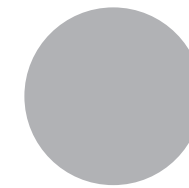

Ice silver, metallic - P5

S line colours

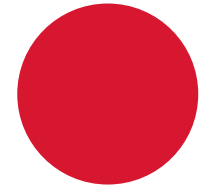

Misano red, pearl effect - N9

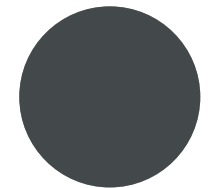

Daytona grey, pearl effect* - 6Y

Optional colours

Basic RRP

£512.50

Total RRP inc VAT

£615.00

S5 colours

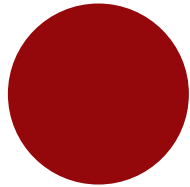

Volcano red, metallic - 1G

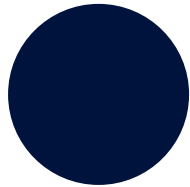

Estoril blue, crystal effect - K0

Hood colours



Red - SF**

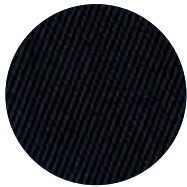

Black - PA

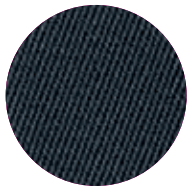

Dark grey - SW**



Brown - PW**

Estoril blue

Basic RRP
£804.17

Total RRP inc VAT
£965.00

Paint

Audi exclusive

Everyone has a favourite colour. No matter what yours is, Audi exclusive provides a range of unique colours that have been designed to set your car apart. Choose from the swatches here, or specify any other paint colour in the Audi range – whether it's Jet blue from the Audi R8 or Alpine white from the original Audi quattro. The choice is yours.

Customised

If you have a particular colour in mind, we'll mix the exact metallic or pearl-effect shade you want.**

**Acoustic hood only

*Visit your local Audi Centre for colour samples

**Custom paint is subject to factory approval, and is available for metallic and pearl-effect water-based paints only. Three-colour process colours and two-tone schemes are not available.

All the colour swatches on this page are matched as accurately as possible to the actual paint colours used. However, due to print processes, Audi UK cannot guarantee that colours shown are 100% accurate.

Visit your local Audi Centre for a more accurate colour swatch.

RRP - Recommended Retail Price.

VAT is calculated at 20% but this may alter to reflect any change in the applicable VAT rate.

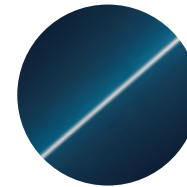

Palace blue, pearl effect

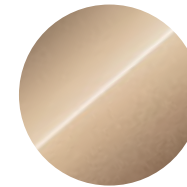

Sand beige, pearl effect

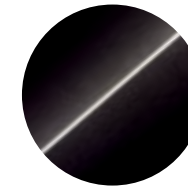

Saddle brown, pearl effect

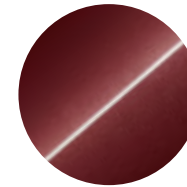

Classic red, pearl effect

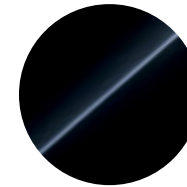

Mamba black, metallic

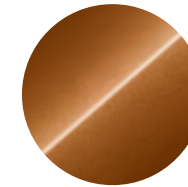

Ipanema brown, metallic



Any colour in the Audi range



100 Audi exclusive colours to choose from*



Customised paint

Audi exclusive

Basic RRP
£1,541.67

Total RRP inc VAT
£1,850.00

Customised

Basic RRP
£2,041.67

Total RRP inc VAT
£2,450.00

Upholstery and seats

Standard seats

Choose your favourite upholstery from the swatches shown opposite to give your car's interior the look and feel you want.

Arcade cloth

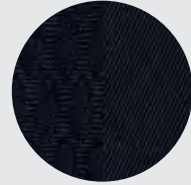

Black - GD/JN



Titanium grey - BI/IJ

Milano leather



Black - GD/JN

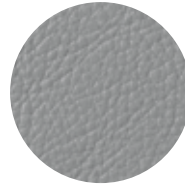

Titanium grey - BI/IJ

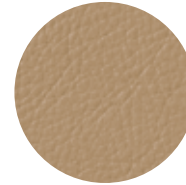

Velvet beige - IF

Standard	SE	S line	S5 quattro	Basic RRP	Total RRP inc VAT
S	-	-	-	No charge	No charge
●	S	-	-	£1,095.83	£1,315.00

Options are subject to availability and may extend delivery.

- = Not available
- = Available
- S = Standard

Colour swatches have been matched as accurately as possible. However, they may not represent the true colour.

All leather upholstery choices include seats, head restraints, door inserts and front centre armrest in leather. Leather/Alcantara choices include head restraints, seat side bolsters and front centre armrest in leather with the seat centres and door inserts in Alcantara.

RRP - Recommended Retail Price.

VAT is calculated at 20% but this may alter to reflect any change in the applicable VAT rate.

Upholstery and seats

Standard seats

Front Standard seats with manual adjustment of seat height, forwards and backwards position, backrest angle and head restraint.

Order Code		Standard	SE	S line	S5 quattro	Basic RRP	Total RRP inc VAT
4A3	Heated front seats with 3-stage heating control	-	●	-	-	£233.33	£280.00
4A4	Heated front and outer rear seats with 3-stage heating control	-	●	-	-	£383.33	£460.00
7P1	Electric lumbar support for front seats with horizontal and vertical adjustment	●	●	-	-	£195.83	£235.00
PV1	Electric front seats, with adjustment for height, forwards and backwards position, backrest angle and lumbar support for driver and front passenger seats	-	●	-	-	£637.50	£765.00
PV3 6XL 4L6	Convenience package. Comprising electric front seats with memory function on driver's side and lumbar support. Also includes folding and auto-dimming door mirrors with memory function and automatic kerb view function, which tilts the passenger mirror downwards towards the kerb when reverse gear is engaged plus auto-dimming rear-view mirror	-	●	-	-	£1,191.67	£1,430.00



Standard seat

Options are subject to availability and may extend delivery.

- = Not available
● = Available
S = Standard

RRP – Recommended Retail Price.

VAT is calculated at 20% but this may alter to reflect any change in the applicable VAT rate.

Upholstery and seats

Sports seats

Choose your favourite upholstery from the swatches shown opposite to give your car's interior the look and feel you want.

Options are subject to availability and may extend delivery.









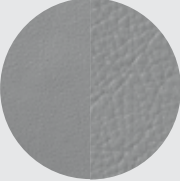

- = Not available
 • = Available
 S = Standard

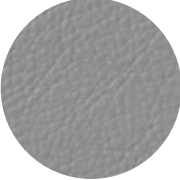
Colour swatches have been matched as accurately as possible. However, they may not represent the true colour.

All leather upholstery choices include seats, head restraints, door inserts and front centre armrest in leather. Leather/Alcantara choices include head restraints, seat side bolsters and front centre armrest in leather with the seat centres and door inserts in Alcantara.

RRP - Recommended Retail Price.

VAT is calculated at 20% but this may alter to reflect any change in the applicable VAT rate.

					Standard	SE	S line	S5 quattro	Basic RRP	Total RRP inc VAT
Leather/Alcantara					-	•	-	-	£404.17	£485.00
	Black - GD/JN	Titanium grey - BI/IJ	Velvet beige - IF							
	Milano leather					-	•	-	-	£404.17
Black - GD/JN		Titanium grey - BI/IJ	Velvet beige - IF							
Fine Nappa leather						-	•	-	-	£708.33
	Black - GD/JN	Titanium grey - BI/IJ	Lunar silver - AI/FW	Red - AA/BF						
										
	Chestnut brown - AO/IH	Chennai brown - TZ	Velvet beige - IF							

Upholstery and seats

Sports seats

Front Sports seats with prominent side bolsters for lateral support when cornering. Also features electric 4-way lumbar support and manual seat adjustment with extendable thigh support.

Options are subject to availability and may extend delivery.

- = Not available
- = Available
- S = Standard

RRP – Recommended Retail Price.

VAT is calculated at 20% but this may alter to reflect any change in the applicable VAT rate.

Order Code		Standard	SE	S line	S5 quattro	Basic RRP	Total RRP inc VAT
4A3	Heated front seats with 3-stage heating control	-	•	-	-	£233.33	£280.00
4A4	Heated front and outer rear seats with 3-stage heating control	-	•	-	-	£383.33	£460.00
PV1	Electric front seats , with adjustment for height, forwards and backwards position, backrest angle and lumbar support for driver and front passenger seats	-	•	-	-	£637.50	£765.00
PV3 6XL 4L6	Convenience package. Comprising electric front seats with memory function on driver's side and lumbar support. Also includes folding and auto-dimming door mirrors with memory function and automatic kerb view function, which tilts the passenger mirror downwards towards the kerb when reverse gear is engaged plus auto-dimming rear-view mirror	-	•	-	-	£1,191.67	£1,430.00



Sports seat (PS1) with electrical adjustment (PV1)

Upholstery and seats

Climate comfort seats

Choose your favourite upholstery from the swatches shown opposite to give your car's interior the look and feel you want.

Milano leather

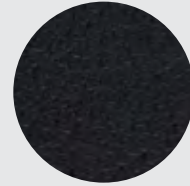

Black - GD/JN

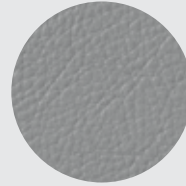

Titanium grey - BI/IJ

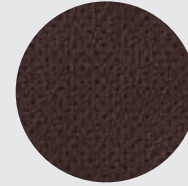

Chestnut brown - AO/IH

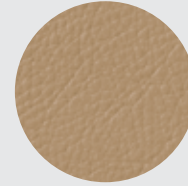

Velvet beige - IF

Standard	SE	S line	S5 quattro	Basic RRP	Total RRP inc VAT
-	•	-	-	£2,545.83	£3,055.00

Options are subject to availability and may extend delivery.

- = Not available
- = Available
- S = Standard

Colour swatches have been matched as accurately as possible. However, they may not represent the true colour.

All leather upholstery choices include seats, head restraints, door inserts and front centre armrest in leather. Leather/Alcantara choices include head restraints, seat side bolsters and front centre armrest in leather with the seat centres and door inserts in Alcantara.

RRP - Recommended Retail Price.

VAT is calculated at 20% but this may alter to reflect any change in the applicable VAT rate.

Upholstery and seats

Climate comfort seats

Front Climate comfort seats with perforated leather on the actively ventilated and heated areas of the front seats and on the non-ventilated areas of the rear seats.

Also includes

- head-level heating system
- electrical adjustment for height, forwards and backwards position, backrest angle and lumbar support
- memory function for driver's seat
- folding and auto-dimming door mirrors with memory function and auto-dimming rear-view mirror
- rear bench with integral storage tray

Options are subject to availability and may extend delivery.

- = Not available
- = Available
- S = Standard

RRP – Recommended Retail Price.

VAT is calculated at 20% but this may alter to reflect any change in the applicable VAT rate.

Order Code		Standard	SE	S line	S5 quattro	Basic RRP	Total RRP inc VAT
4A4	Heated front and outer rear seats with 3-stage heating control	-	•	-	-	£150.00	£180.00



Climate comfort seat

Upholstery and seats

S line Sports seats

Choose your favourite upholstery from the swatches shown opposite to give your car's interior the look and feel you want.

Leather/Alcantara



Black with grey stitching - QZ

Fine Nappa leather



Black - QE

	Standard	SE	S line	S5 quattro	Basic RRP	Total RRP inc VAT
Leather/Alcantara	-	-	●	-	No charge	No charge
Fine Nappa leather	-	-	S	-	No charge	No charge

Options are subject to availability and may extend delivery.

- = Not available
- = Available
- S = Standard

Colour swatches have been matched as accurately as possible. However, they may not represent the true colour.

All leather upholstery choices include seats, head restraints, door inserts and front centre armrest in leather. Leather/Alcantara choices include head restraints, seat side bolsters and front centre armrest in leather with the seat centres and door inserts in Alcantara.

RRP - Recommended Retail Price.

VAT is calculated at 20% but this may alter to reflect any change in the applicable VAT rate.

Upholstery and seats

S line Sports seats

Front Sports seats with S line embossing and prominent side bolsters for lateral support when cornering. Also features electric 4-way lumbar support and manual seat cushion angle adjustment with extendable thigh support.

Options are subject to availability and may extend delivery.

- = Not available
- = Available
- S = Standard

RRP – Recommended Retail Price.

VAT is calculated at 20% but this may alter to reflect any change in the applicable VAT rate.

Order Code		Standard	SE	S line	S5 quattro	Basic RRP	Total RRP inc VAT
4A3	Heated front seats with 3-stage heating control	-	-	•	-	£233.33	£280.00
4A4	Heated front and outer rear seats with 3-stage heating control	-	-	•	-	£383.33	£460.00
PV1	Electric front seats, with adjustment for height, forwards and backwards position, backrest angle and lumbar support for driver and front passenger seats	-	-	•	-	£379.17	£455.00
PV3 6XL 4L6	Convenience package. Comprising electric front seats with memory function on driver's side and lumbar support. Also includes folding and auto-dimming door mirrors with memory function and automatic kerb view function, which tilts the passenger mirror downwards towards the kerb when reverse gear is engaged plus auto-dimming rear-view mirror	-	-	•	-	£933.33	£1,120.00



S line Sports seats

Upholstery and seats

S5 Cabriolet Super Sports seats

Choose your favourite upholstery from the swatches shown opposite to give your car's interior the look and feel you want.

Options are subject to availability and may extend delivery.

- = Not available
- = Available
- S = Standard

Colour swatches have been matched as accurately as possible. However, they may not represent the true colour.

All leather upholstery choices include seats, head restraints, door inserts and front centre armrest in leather. Leather/Alcantara choices include head restraints, seat side bolsters and front centre armrest in leather with the seat centres and door inserts in Alcantara.

RRP – Recommended Retail Price.

VAT is calculated at 20% but this may alter to reflect any change in the applicable VAT rate.

Fine Nappa leather



Black/Black – ZM/SC

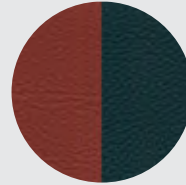

Magma red/Black – FA/SJ

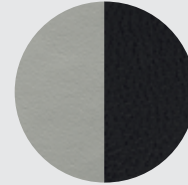

Lunar silver/Black – FI/SU



Chestnut brown/Black – FO/SV

Standard	SE	S line	S5 quattro	Basic RRP	Total RRP inc VAT
-	-	-	S	No charge	No charge

Upholstery and seats

S5 Cabriolet Super Sports seats

S5 Super Sports seats with integral head restraints, electrical adjustment of seat height, forwards and backwards position, backrest and seat angle. Also includes electric 4-way lumbar support, extendable thigh supports and rear bench with integral centre storage tray.

Options are subject to availability and may extend delivery.

- = Not available
- = Available
- S = Standard

RRP – Recommended Retail Price.

VAT is calculated at 20% but this may alter to reflect any change in the applicable VAT rate.

Order Code		Standard	SE	S line	S5 quattro	Basic RRP	Total RRP inc VAT
4A3	Heated front seats with 3-stage heating control	-	-	-	•	£233.33	£280.00
4A4	Heated front and outer rear seats with 3-stage heating control	-	-	-	•	£383.33	£460.00
PV3 6XL 4L6	Convenience package. Comprising electric front seats with memory function on driver's side and lumbar support. Also includes folding and auto-dimming door mirrors with memory function and automatic kerb view function, which tilts the passenger mirror downwards towards the kerb when reverse gear is engaged plus auto-dimming rear-view mirror	-	-	-	•	£512.50	£615.00



S5 Super Sports seat

Colour and trim guide

Interior trim colours

Standard seats

To help you choose the right interior for your Audi A5 Cabriolet, please use this guide, showing the carpet, dashboard and headlining colours that have been matched to your chosen upholstery. Please note that the inlay colour may change dependent on the interior colours you select, please see page 40 for details

Sports seats (PS1)

S line Sports seats

Options are subject to availability and may extend delivery.

- = Not available
- = Available
- S = Standard

*Includes leather door armrests (7HB)

Order Code	Upholstery	Carpet	Dashboard (upper/lower)	Headlining	Arcade cloth (N0B)	Milano leather (N5W)
GD or JN	Black	Black	Black/Black	Silver or Black	•	•
BI or IJ	Titanium grey	Grey	Grey/Grey	Silver or Black	•	•
IF	Velvet beige	Brown	Brown/Brown	Beige	—	•

Order Code	Upholstery	Carpet	Dashboard (upper/lower)	Headlining	Leather/Alcantara (N7U)	Milano leather (N5W)	Fine Nappa leather (N3Q)*
GD or JN	Black	Black	Black/Black	Silver or Black	•	•	•
BI or IJ	Titanium grey	Grey	Grey/Grey	Silver or Black	•	•	•
AI or FW	Lunar silver	Black	Black/Black	Silver or Black	—	—	•
AO or IH	Chestnut brown	Black	Black/Black	Silver or Black	—	—	•
AA or BF	Red	Black	Black/Black	Silver or Black	—	—	•
TZ	Chennai brown	Black	Black/Black	Black	—	—	•
IF	Velvet beige	Brown	Brown/Brown	Beige	•	•	•

Order Code	Upholstery	Carpet	Dashboard (upper/lower)	Headlining	Leather/Alcantara (N7K)	Fine Nappa leather (N2R)*
QE (Black stitching)	Black	Black	Black/Black	Black	—	•
QZ (Grey stitching)	Black	Black	Black/Black	Black	•	—

Colour and trim guide

Interior trim colours

Climate comfort seats (PS8)

Order Code	Upholstery	Carpet	Dashboard (upper/lower)	Headlining	Milano leather (N5W)
GD or JN	Black	Black	Black/Black	Silver or Black	●
BI or IJ	Titanium grey	Grey	Grey/Grey	Silver or Black	●
AO or IH	Chestnut brown	Black	Black/Black	Silver or Black	●
IF	Velvet beige	Brown	Brown/Brown	Beige	●

S5 Cabriolet Super Sports seats

Order Code	Upholstery	Carpet	Dashboard (upper/lower)	Headlining	Fine Nappa leather (N3M)*
FI or SU	Lunar silver/Black	Black	Black/Black	Silver or Black	●
FO or SV	Chestnut brown/Black	Black	Black/Black	Silver or Black	●
SJ or FA	Magma red/Black	Black	Black/Black	Silver or Black	●
SC or ZM	Black/Black	Black	Black/Black	Silver or Black	●

Options are subject to availability and may extend delivery.

- = Not available
- = Available
- S = Standard

*Includes leather door armrests (7HB)

Upholstery

Audi exclusive

With Audi exclusive, you can specify your seats in Fine Nappa leather or Fine Nappa leather/Alcantara, in an array of different colours shown to the right.

Select just one all-over shade for each seat, or customise each panel in two or more complementary colours from the distinctive Audi exclusive palette. You can even choose the colour of the decorative stitching – to match or contrast with your chosen upholstery – from this varied collection. Whatever combination you decide upon, we think you'll be extremely comfortable with the result.

Options are subject to availability and may extend delivery.

– = Not available
• = Available
S = Standard

*Leather and stitching (where applicable) can be specified in a variety of colours from the Audi exclusive range.

RRP – Recommended Retail Price.

VAT is calculated at 20% but this may alter to reflect any change in the applicable VAT rate.

Order Code		Standard	SE	S line	S5 quattro	Basic RRP	Total RRP inc VAT
PYD S3G	Audi exclusive leather package 2 in Fine Nappa leather. Includes leather-covered seat upholstery, door trim inserts, front centre armrest, backrest covers and door armrests and handles. Add-on parts and seat side trims come in the interior trim colour.* Not available in combination with Climate comfort seats. Only available in combination with electric seats (PV1 or PV3)	–	•	•	–	£3,291.67	£3,950.00
PYF S3G	Audi exclusive leather package 2 in Fine Nappa leather/Alcantara. Includes leather-covered seat side trims and backrest covers, front centre armrest, door armrests and Alcantara seat centre sections and door trim inserts. Seat side trims and add-on parts are colour coordinated. *Only in combination with Sports seats	–	•	•	–	£3,291.67	£3,950.00



Chestnut brown

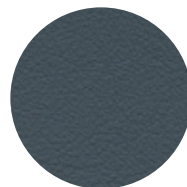

Jet grey



Alabaster white

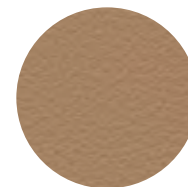

Sand beige



Saddle brown

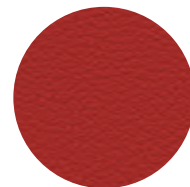

Crimson red



Magnolia white



Havana brown

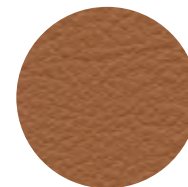

Cognac brown

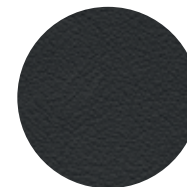

Night blue

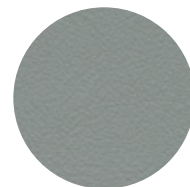

Cloudy grey

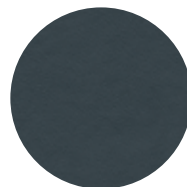

Smoky blue

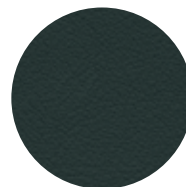

Iceland green



Powder beige



Classic red

Also available:

Alcantara colours: available in all the Audi exclusive colours shown, except for Crimson red, Jet grey and Sand beige. Alcantara equivalents are Chilli red, Amethyst grey, and Sesame beige respectively.

Please consult your Audi Centre for examples of Alcantara and carpet colours.

Upholstery

Audi exclusive line

Audi exclusive is ultimately about choice – but if you'd rather leave some of the decisions in the capable hands of our designers, the expert team at quattro GmbH have compiled Audi exclusive line, combining some of the most popular elements of the exclusive range in one, beautifully coordinated package.

Options are subject to availability and may extend delivery.

– = Not available
 • = Available
 S = Standard

RRP – Recommended Retail Price.

VAT is calculated at 20% but this may alter to reflect any change in the applicable VAT rate.

Order Code		Standard	SE	S line	S5 quattro	Basic RRP	Total RRP inc VAT
WQK	Audi exclusive line	–	•	–	–	£2,250.00	£2,700.00

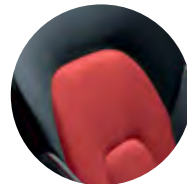

Crimson red – QY

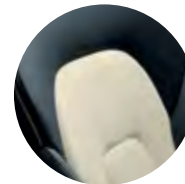

Alabaster white – UA

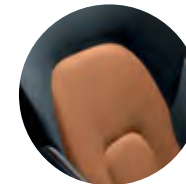

Cognac brown – QX

This package includes

- ▶ Sports seats in two-tone Fine Nappa leather – black seat-side sections with coloured stitching and coloured seat-centre section in Crimson red, Alabaster white or Cognac brown
- ▶ Door trim inserts match seat centre section, and arm rests in doors in black leather with coloured stitching to match seat centre section
- ▶ Black dashboard and carpets
- ▶ Black cloth headlining
- ▶ Audi exclusive door sill trims
- ▶ Matt-brushed aluminium inlays
- ▶ Floor mats in black with coloured piping (to match seat-centre section)
- ▶ 3-spoke leather steering wheel (S tronic with shift paddles)
- ▶ Steering wheel rim and gear lever gaiter with coloured stitching in matching colour to seat-centre section
- ▶ Head restraints with coloured stitching in matching colour to seat-centre section

Inlays

Inlays are the all-important finishing touch that add flair and interest to your car's interior.

Order Code		Standard	SE	S line	S5 quattro	Basic RRP	Total RRP inc VAT
5MA	Reflex finish, Steel grey or Moor brown*	S	S	–	–	No charge	No charge
5TG	Matt-brushed aluminium	–	–	S	S	No charge	No charge
5TZ	Fine grain birch wood, grey	–	–	●	●	£275.00	£330.00
5MG	Walnut, brown	●	●	–	–	£275.00	£330.00
5MZ	Stainless steel mesh (centre console comes in Piano finish, black)	–	–	–	●	£304.17	£365.00
5MU	Aluminium Trigon	●	●	–	–	£129.17	£155.00
7TL	Fine grain ash, natural brown	●	●	–	–	£275.00	£330.00
5MK	Carbon atlas	–	–	–	●	£212.50	£255.00
5MT	Beaufort oak	–	●	–	–	£375.00	£450.00
5TL	Piano finish, black	–	–	●	–	No charge	No charge

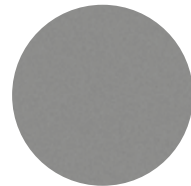

Reflex finish, Steel grey – **5MA**



Reflex finish, Moor brown – **5MA**

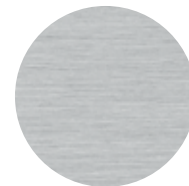

Matt-brushed aluminium – **5TG**



Fine grain birch wood, grey – **5TZ**



Walnut, brown – **5MG**



Stainless steel mesh (centre console comes in Piano finish, black) – **5MZ**

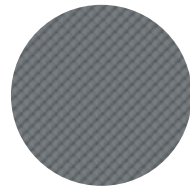

Aluminium Trigon – **5MU**

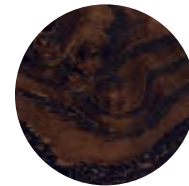

Fine grain ash, natural brown – **7TL**

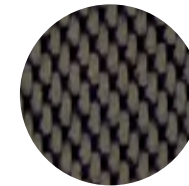

Carbon atlas – **5MK**



Beaufort oak – **5MT**

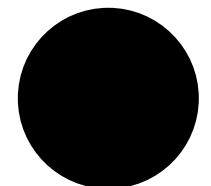

Piano finish, black – **5TL**

Options are subject to availability and may extend delivery.

- = Not available
- = Available
- S = Standard

*Inlay colour dependent on interior colour, grey and black interiors will have Reflex finish, Steel grey inlays. Beige interiors will have Reflex finish, Moor brown inlays.

RRP – Recommended Retail Price.

VAT is calculated at 20% but this may alter to reflect any change in the applicable VAT rate.

Inlays

Audi exclusive

Audi exclusive has sourced a range of materials which you can select for your inlays, from Sepia oak to Fine grain myrtle.

Order Code		Standard	SE	S line	S5 quattro	Basic RRP	Total RRP inc VAT
YTA S3G	Audi exclusive inlays (cannot be combined with the inlays shown on page 40)	-	•	•	•	£791.67	£950.00



Fine grain ash, nougat



Fine grain myrtle, nutmeg



Oak, sepia

Options are subject to availability and may extend delivery.

- = Not available
- = Available
- S = Standard

RRP - Recommended Retail Price.

VAT is calculated at 20% but this may alter to reflect any change in the applicable VAT rate.

Wheels, tyres and suspension

Choose a set of specially-selected alloy wheels to subtly enhance the way your car looks and drives. And you can also specify Audi drive select, which allows you to change suspension and steering settings according to your driving style.



18" x 8.5J '5 double-spoke' design alloy wheels – PQG



18" x 8.5J '10-spoke' design alloy wheels – PQ5



18" x 8.5J '5 V-spoke' design alloy wheels – PRM



19" x 8.5J '10-spoke' design alloy wheels – PRK



18" x 8.5J '15-spoke star' design alloy wheels – PRR



19" x 8.5J '5-spoke Y' design alloy wheels – PRV



19" x 9J '20-spoke' design, 2-piece alloy wheels – PQS



19" x 9J '5-segment-spoke' design alloy wheels – PQ6



20" x 9J '7-arm double-spoke' design alloy wheels – PQF

Options are subject to availability and may extend delivery.

– = Not available
• = Available
S = Standard

RRP – Recommended Retail Price.

VAT is calculated at 20% but this may alter to reflect any change in the applicable VAT rate.

Wheels, tyres and suspension

Order Code		Standard	SE	S line	S5 quattro	Basic RRP	Total RRP inc VAT
CD7	17" x 7.5J '5-arm' design alloy wheels with 225/50 R17 tyres	●	S	—	—	£166.67	£200.00
PQG	18" x 8.5J '5 double-spoke' design alloy wheels with 245/40 R18 tyres	—	●	—	—	£1,041.67	£1,250.00
PQ5	18" x 8.5J '10-spoke' design alloy wheels with 245/40 R18 tyres	—	—	●	—	No charge	No charge
PRM	18" x 8.5J 'S V-spoke' design alloy wheels with 245/40 R18 tyres	—	●	—	—	£554.17	£665.00
PRK	19" x 8.5J '10-spoke' design alloy wheels with 255/35 R19 tyres	—	●	—	—	£1,125.00	£1,350.00
PRR	18" x 8.5J '15-spoke star' design alloy wheels with 245/40 R18 Y tyres	—	●	—	—	£516.67	£620.00
PRV	19" x 8.5J '5-spoke Y' design alloy wheels with 255/35 R19 Y tyres	—	●	—	—	£1,108.33	£1,330.00
PQS	19" x 9J '20-spoke' design, 2-piece alloy wheels with 255/35 R19 Y tyres (only available in combination with quattro). Not available on 2.0 TDI 177PS quattro	—	—	●	—	£383.33	£460.00
PQ6	19" x 9J '5-segment-spoke' design alloy wheels with 255/35 R19 tyres	—	●	—	—	£1,191.67	£1,430.00
PQF	20" x 9J '7-arm double-spoke' design alloy wheels with 265/30 R20 tyres (not available on 3.0 TDI 204PS, 1.8 TFSI or 2.0 TDI 143PS engines)	—	—	●	—	£937.50	£1,125.00
		—	—	—	●	£825.00	£990.00
2H1	Audi drive select changes your car's handling and responses at the touch of a button to suit the way you want to drive. There are five modes: comfort, dynamic, auto, individual and efficient. Please note that you can only choose the 'individual' mode and customise your settings if you also have Satellite Navigation installed. When operating in efficiency mode, the engine and gear shift programmes are altered to optimise fuel consumption. The air conditioning system is also configured to allow for optimum energy use	—	●	●	●	£183.33	£220.00
1N8	Dynamic steering – with this new technology, driving is significantly more agile under everyday conditions, while directional stability and precision are increased at high speeds and in demanding driving situations. Must be combined with Audi drive select	—	●	●	●	£604.17	£725.00
1BL	Damper control – formed on the basis of lowered Sports suspension, the optional damper control system fine tunes suspension settings according to road conditions and driver needs. Must be combined with Audi drive select	—	●	—	—	£566.67	£680.00
		—	—	●	●	£250.00	£300.00
GH2	Audi quattro Sports differential – must be combined with Audi drive select, only available on 3.0 TDI 245PS and 3.0 TFSI quattro engines	—	●	●	●	£516.67	£620.00
1BE	Sports suspension , with stiffer springs and shock absorbers and a 20mm lower ride height	●	●	S	—	£212.50	£255.00
1BV	S line Sports suspension , lowered by 30mm with more firmly tuned springs and dampeners for more direct contact with the road	—	—	●	—	No charge	No charge

Options are subject to availability and may extend delivery.

— = Not available
● = Available
S = Standard

RRP – Recommended Retail Price.

VAT is calculated at 20% but this may alter to reflect any change in the applicable VAT rate.

Packages

Some items work well together, which is why we've created these special packages. They provide increased convenience and value by combining several of our most popular options.

Options are subject to availability and may extend delivery.

- = Not available
- = Available
- S = Standard

RRP – Recommended Retail Price.

VAT is calculated at 20% but this may alter to reflect any change in the applicable VAT rate.

Order Code	Standard	SE	S line	S5 quattro	Basic RRP	Total RRP inc VAT
WB3 QV3 Sound package Featuring Bang & Olufsen sound system and DAB digital radio Bang & Olufsen sound system. Designed specifically for the Audi A5 Cabriolet, providing 5.1 surround sound reproduction with dynamic compensation for road noise, 10-channel amplifier and 12 high-performance loudspeakers (total output 505 Watts) DAB digital radio. Receives programmes from digital radio transmitters in addition to the range of analogue stations, with better sound quality	-	•	•	•	£500.00	£600.00
WB6 Technology package – High Featuring MMI Navigation system – HDD-based with Audi Music Interface and Audi parking system plus MMI Navigation system plus. Hard disk navigation with topographical map display places of interest and town models in 3D, with high-resolution 7" colour TFT display. The system offers three alternative routes, with the ability to scroll along the selected route and manoeuvre within the map. Uses 7-digit postcode recognition. Includes split-screen mode for route information, dynamic route guidance (TMC), intersection zoom function, motorway exits and lane recommendations in Driver's Information System (DIS). When combined with mobile telephone preparation – High with Audi connect (9ZW), the system uses Google Earth images for navigation. Includes 2 SD card readers, single CD/DVD player and 40GB hard drive, Jukebox (20GB) for storing and managing music files in WMA and MP3 format. Includes European navigation data (where digitalised) Audi Music Interface. Connection for use with stereo audio sources, USB and MP3 devices including Apple iPod generation 4 onwards and Apple iPhone Audi parking system plus. Acoustic and visual park assist system for the front and rear	-	•	•	•	£1,662.50	£1,995.00



Satellite Navigation – HDD-based with MMI 3G



MMI 3G Control – High (part of HDD Navigation)

Packages

Order Code	Standard	SE	S line	S5 quattro	Basic RRP	Total RRP inc VAT
PCB WB6 001 Technology Package – Advanced Includes all the features of Technology package – High as well as Adaptive cruise control with braking guard . Intelligent automatic speed and distance control system. Works at speeds from 19-155*mph, using radar sensors to measure and maintain required distance to vehicle ahead by braking and accelerating. Four programs (distance 1 to distance 4) set via steering column controls of the cruise control system. Includes Audi braking guard – a system which triggers a visual and acoustic alarm when it detects the risk of a rear end collision with the vehicle in front. At speeds below 19mph the system can initiate partial braking or full deceleration if a potential impact is detected to help prevent a collision, or if it is not possible to completely prevent a collision, the system will focus on reducing the speed at which the vehicles collide Audi active lane assist . Helps the driver to stay in lane with gentle steering impulses for greater safety and convenience, particularly on motorways and country roads. The system informs the driver if the car is drifting out of its lane unintentionally	–	•	•	•	£2,183.33	£2,620.00

Options are subject to availability and may extend delivery.

- = Not available
- = Available
- S = Standard

*Where law permits.

RRP – Recommended Retail Price.

VAT is calculated at 20% but this may alter to reflect any change in the applicable VAT rate.



Audio and communication

Stay in touch using our range of communication functions, and give each journey its own soundtrack with our advanced audio equipment.

Options are subject to availability and may extend delivery.

- = Not available
- = Available
- S = Standard

RRP – Recommended Retail Price.

VAT is calculated at 20% but this may alter to reflect any change in the applicable VAT rate.

Order Code		Standard	SE	S line	S5 quattro	Basic RRP	Total RRP inc VAT
BUM	Audi Symphony radio. AM/FM twin tuner with TP memo function. Front-loading 6-CD changer with MP3 compatibility and active front and rear speakers. Includes colour centre console screen, SD memory-card reader and AUX-IN socket. Cannot be combined with Satellite Navigation	•	•	•	•	£233.33	£280.00
QV3	DAB digital radio. Integrated into MMI, receives digitally-transmitted radio stations in addition to the range of analogue stations. Displays music track, artist and radio program. Capable of 'DAB Slideshow' where transmitted. Reception dependent on local digital network. Automatic switch from DAB to FM reception if the network signal is not strong enough	-	•	•	•	£254.17	£305.00
9VK	Bang & Olufsen sound system. Designed specifically for the Audi A5 Cabriolet, providing 5.1 surround sound reproduction with dynamic compensation for road noise, 10-channel amplifier and 12 high-performance loudspeakers (total output 505 Watts)	-	•	•	•	£445.83	£535.00
PNW	Satellite Navigation system – DVD-based. Includes MMI High and colour Driver's Information System (DIS). Integrated into the MMI is a clear map display with special destinations indicated by symbols, high-speed map loading, zoom function, selection of address book destinations, target memory, 5 digit postcode entry, dynamic route guidance with TMC (with vehicle life subscription), including Europe DVD (where digitised). CD changer is recommended with this option	-	•	•	•	£1,350.00	£1,620.00



Audi Symphony radio



Bang & Olufsen sound system

Audio and communication

Order Code		Standard	SE	S line	S5 quattro	Basic RRP	Total RRP inc VAT
9ZX	Mobile telephone preparation – Bluetooth interface. Provides handsfree connection via Bluetooth using mobile phone aerial. Please contact your Audi Centre for phone compatibility. Only in combination with multi-function steering wheel	●	S	S	S	£216.67	£260.00
PT5	Mobile telephone preparation – Low with Bluetooth. Provides handsfree connection via Bluetooth using the mobile phone aerial. Alternatively, it can use a cradle with charging facility for optimal reception via external aerial. Located in front centre armrest. Cradle available at extra cost – please contact your Audi Centre for phone compatibility. Only in combination with Concert or Symphony radio and multi-function steering wheel	●	–	–	–	£445.83	£535.00
		–	●	●	–	£145.83	£175.00
9ZW	Mobile telephone preparation – High with Audi connect. A mobile phone can be connected to the internal UMTS (3G) module via Bluetooth (provided the mobile telephone has SIM Access Profile ¹), or alternatively through the additional SIM card reader. ² It is possible to transfer phone book entries to the car and manage call lists. Audi connect features include: navigation using Google Earth images and Google Street View, destination entry via Google Maps or myAudi, online point of interest search and information services such as weather forecasts and the latest world news. Audi connect also includes Audi traffic information online, which gives accurate real-time forecasts of the traffic situation along the chosen route. The traffic situation can be displayed on the navigation map or Google Earth image. Audi connect can also create a Wi-Fi hotspot in the car for convenient internet access using a mobile device (e.g. laptop or tablet). ³ Many Audi connect features can be simply operated via MMI Navigation Plus, or the multi-function steering wheel. Only in combination with Technology package – High (WB6/001)	–	●	●	●	£291.67	£350.00
UF7 001	Audi Music Interface (AMI). Universal connection for use with stereo audio sources, USB and MP3 devices including Apple iPod generation 4 onwards (iPod, iPod classic, iPod mini, iPod nano, iPod photo, iPod video, iPod touch). Provides intuitive control through the audio system and multi-function steering wheel (where fitted). It also replicates the iPod display on the audio screen and DIS, including track titles. The interface provides charging function (dependent on device). (Includes 2 cables to connect your iPod or USB MP3 device.) AUX-IN is deleted with this option	–	●	●	●	£212.50	£255.00
7A6	CD changer. For six CDs with MP3 compatibility. Operated via MMI system. Only in combination with Satellite Navigation – DVD-based (PNW)	–	●	●	●	£254.17	£305.00
7D1	CD changer and DVD player. 6-CD changer located in the glove box and single CD/DVD slot in centre console. Only in combination with technology package – High (WB6)	–	●	●	●	£254.17	£305.00
QU7	Digital TV reception. Reception of digital (DVB-T) uncoded television stations (MPEG-2 standard), TV picture, teletext and Electronic Programme Guide (EPG). Facility to connect 2 external AV sources via adapter cables (available from Audi Genuine Accessories). Please note: TV reception depends on local digital network availability. No AV or TV video output when driving (audio output available when driving). Only in combination with technology package – High (WB6)	–	●	●	●	£725.00	£870.00
QU6	Digital TV Reception and DAB digital radio reception. Reception of digital (DVB-T) uncoded television stations (MPEG-2 standard), TV picture, teletext and Electronic Programme Guide (EPG). Facility to connect 2 external AV sources via adapter cables (available from Audi Genuine Accessories). Please note: TV reception depends on local digital network availability. No AV or TV video output when driving (audio output available when driving). Only in combination with technology package – High (WB6)	–	●	●	●	£979.17	£1,175.00
		–	●	●	●	£725.00	£870.00

Options are subject to availability and may extend delivery.

- = Not available
- = Available
- S = Standard

¹To check the compatibility of your mobile phone and whether it has SIM Access Profile compatibility, please visit www.audi.co.uk/owners-area/phone-compatibility.html

²Please note that when a data SIM card is inserted into the SIM card reader, Bluetooth handsfree connectivity is disabled as the SIM card takes priority over the Bluetooth connection.

³Online services are only available for mobile phone contracts including a data option and only within the coverage of the mobile phone network; there may be additional costs for the use of these services (charges and billing correspond to the personal mobile phone contract). Due to high data volumes, a mobile phone contract including an unlimited data plan is strongly recommended. The content and scope of the online-based services offered may vary.

RRP – Recommended Retail Price.

VAT is calculated at 20% but this may alter to reflect any change in the applicable VAT rate.

Interior equipment

Specify every detail of your car's interior with this range of options.

Options are subject to availability and may extend delivery.

- = Not available
 ● = Available
 S = Standard

*HomeLink® is a registered trademark of Johnson Controls. For information on compatibility, visit www.homelink.com

RRP – Recommended Retail Price.

VAT is calculated at 20% but this may alter to reflect any change in the applicable VAT rate.

Order Code		Standard	SE	S line	S5 quattro	Basic RRP	Total RRP inc VAT
4F2	Advanced key. Access and authorisation system which automatically exchanges data between key and vehicle, allowing the driver to keep the key in their pocket or bag at all times. To unlock and open, simply lift the exterior door handle. To lock, press the button on the handle. Pressing the start/stop button integrated in the centre console starts and stops the engine	-	●	●	●	£420.83	£505.00
4L6	Auto-dimming rear-view mirror. Includes acoustic windscreen	-	●	●	●	£187.50	£225.00
8T1	Cruise control. For holding any speed above 25mph	●	●	●	●	£187.50	£225.00
8T4	Adaptive cruise control (ACC) with braking guard. Adaptive cruise control with braking guard. Intelligent automatic speed and distance control system. Works at speeds from 19-155mph, using radar sensors to measure and maintain required distance to vehicle ahead by braking and accelerating. Four programs (distance 1 to distance 4) set via steering column controls of the cruise control system. Includes Audi braking guard – a system which triggers a visual and acoustic alarm when it detects the risk of a rear end collision with the vehicle in front. At speeds below 19mph the system can initiate partial braking or full deceleration if a potential impact is detected to help prevent a collision, or if it is not possible to completely prevent a collision, the system will focus on reducing the speed at which the vehicles collide	-	●	●	●	£937.50	£1,125.00
VC1	Garage door opener (Homelink®*). Programmable radio-operated remote control for compatible doors/gates. Control buttons integrated in the front roof module	●	●	●	●	£150.00	£180.00
QQ1	Interior light package. Includes front and rear footwell lighting, active door reflectors, illuminated vanity mirrors, entrance lights and illuminated glove compartment, vents and internal door controls	●	●	●	S	£83.33	£100.00



Adaptive cruise control



Advanced key

Interior equipment

Options are subject to availability and may extend delivery.

- = Not available
 ● = Available
 S = Standard

*The leather, stitching and piping (where applicable) can be selected from any of the Audi exclusive colours shown on page 38. The carpet colour can also be selected from any of the Audi exclusive colours shown on page 38, except for Crimson red and Saddle brown.

RRP – Recommended Retail Price.

VAT is calculated at 20% but this may alter to reflect any change in the applicable VAT rate.

Order Code		Standard	SE	S line	S5 quattro	Basic RRP	Total RRP inc VAT
9K1	Head-level heating system. Includes vents in the front seat backrest that blow hot air onto your neck as you drive. Can be adjusted in three stages. Only in combination with heated front Sports seats or Climate comfort seats	-	●	●	-	£291.67	£350.00
7HB	Leather armrests. Includes leather covered armrest on door panels for front and rear	-	●	S	S	£170.83	£205.00
7S1	Wind deflector. To reduce draughts and wind noise. Manually attached to mounting in rear seating area. Can be folded for compact storage	●	S	S	S	£225.00	£270.00
YSR S3G	Audi exclusive floor mats with leather piping.* Includes 4 floor mats for front and rear (cannot be combined with option YSQ/S3G – Audi exclusive carpets)	-	●	●	●	£375.00	£450.00
YSQ S3G	Audi exclusive carpets.* Includes 4 Audi exclusive floor mats with leather piping (cannot be combined with option YSR/S3G – Audi exclusive floor mats)	-	●	●	●	£812.50	£975.00
6Q6	Audi exclusive aluminum gear knob. Manual gearboxes only	-	●	●	-	£125.00	£150.00
3X2	Ski/snowboard bag	●	●	●	●	£58.33	£70.00



Head-level heating

Exterior equipment

Make sure your car looks exactly as you want it to by selecting some of our striking options.

Order Code		Standard	SE	S line	S5 quattro	Basic RRP	Total RRP inc VAT
8N7	High-beam assist. Automatically adjusts headlights from high-beam to dipped-beam when another vehicle is approaching. Only in combination with auto-dimming rear-view mirror	–	●	●	●	£91.67	£110.00
8Q5	Adaptive lights. Swivelling headlights for improved illumination of a winding road	–	–	●	●	£275.00	£330.00
PX1 8Q5	Adaptive headlights. Swivelling headlights for improved illumination of a winding road. Includes Xenon Plus headlights with LED daytime-running lights and headlight washers	–	●	–	–	£941.67	£1,130.00
3FT	Acoustic hood – fully automatic. Additional foam layer within hood reduces wind noise further. Includes rear LED reading lights	●	●	S	S	£183.33	£220.00
2Z0	Deletion of model and engine technology designation at rear	●	●	●	–	No charge	No charge
2Z7	Deletion of engine technology designation at rear	●	●	●	–	No charge	No charge
6XE	Door mirrors – electrically adjustable, folding and heated	–	●	●	●	£150.00	£180.00
6XK 4L6	Door mirrors – electrically folding and auto-dimming. Includes auto-dimming rear-view mirror and automatic kerb view function, which tilts the passenger mirror downwards towards the kerb when reverse gear is engaged	–	●	●	●	£404.17	£485.00
1D2	Tow bar – removable. Includes single European 13-pin electrics socket and may require a 13- to 7-pin adapter. Please consult your Audi Centre for details*	●	●	●	–	£554.17	£665.00

Options are subject to availability and may extend delivery.

– = Not available
● = Available
S = Standard

*Additional wiring is required for auxiliary equipment

RRP – Recommended Retail Price.

VAT is calculated at 20% but this may alter to reflect any change in the applicable VAT rate.

Safety and security

Intelligent technology designed to give you better all-round awareness and safety on the road.

Options are subject to availability and may extend delivery.

- = Not available
- = Available
- S = Standard

RRP – Recommended Retail Price.

VAT is calculated at 20% but this may alter to reflect any change in the applicable VAT rate.

Order Code		Standard	SE	S line	S5 quattro	Basic RRP	Total RRP inc VAT
7X1	Acoustic parking system (rear only). Aids parking by acoustically indicating distances to obstacles	•	S	S	S	£279.17	£335.00
7X4	Audi parking system plus. Aids parking by acoustically and visually indicating distances to obstacles	-	•	•	•	£270.83	£325.00
7X8	Audi parking system advanced. Aids parking by acoustically and visually indicating distances to obstacles with guiding lines. Measured by sensors and reversing camera. Only in combination with technology package or Satellite Navigation – DVD-based In combination with Technology package	-	•	•	•	£554.17	£665.00
		-	•	•	•	£283.33	£340.00
UH2	Audi hill-hold assist. Uses either the ESP system or electromechanical parking brake to hold the vehicle stationary	•	•	•	•	£54.17	£65.00
7Y4	Audi active lane assist. Uses a discreet camera mounted at the top of the windscreen to monitor the road ahead. Assists the driver to stay in lane with gentle steering impulses. Informs the driver if the car is drifting out of lane unintentionally above 37mph. Choice of two settings; early steering intervention with continuous steering impulses to centre vehicle in lane; late steering intervention, alerts the driver that the vehicle is potentially crossing lanes and applies corrective steering prompt	-	•	•	•	£383.33	£460.00
7Y1	Audi side assist. Aids the driver when changing lane. Audi side assist monitors the area behind the car using radar sensors located discreetly in the rear bumper, informing the driver with a visual warning signal in the door mirror if there is a vehicle in their blind spot or approaching quickly from behind. The system is activated using a button in the driver's door	-	•	•	•	£383.33	£460.00
7K6	Tyre pressure loss indicator. A visual and acoustic warning when the system detects a potential loss of tyre pressure	•	•	•	•	£62.50	£75.00



Audi active lane assist (setting 1: early steering intervention)

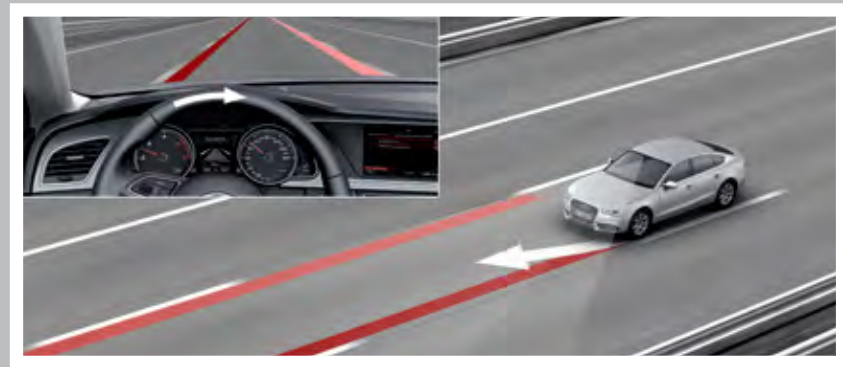

Audi active lane assist (setting 2: late steering intervention)

Steering wheels

You can choose from a selection of advanced leather multi-function steering wheels, allowing you to control your audio system at the touch of a button.

Options are subject to availability and may extend delivery.

- = Not available
 ● = Available
 S = Standard

*The leather and stitching (where applicable) can be selected from any of the Audi exclusive colours shown on page 38.

RRP – Recommended Retail Price.

VAT is calculated at 20% but this may alter to reflect any change in the applicable VAT rate.

Order Code		Standard	SE	S line	S5 quattro	Basic RRP	Total RRP inc VAT
1XW	3-spoke multi-function steering wheel. Manual models only	●	S	S	S	£212.50	£255.00
1XX	3-spoke multi-function steering wheel with gear-shift paddles. S tronic models only	●	S	S	S	£329.17	£395.00
2PF	3-spoke multi-function flat bottomed steering wheel. Manual models only	-	●	●	-	£83.33	£100.00
2PK	3-spoke multi-function flat bottomed steering wheel with gear-shift paddles. Automatic models only	-	●	●	●	£83.33	£100.00
YRH S3G	Audi exclusive leather-covered steering wheel*	-	●	●	●	£375.00	£450.00
YRB S3G	Audi exclusive controls package* – includes leather-covered steering wheel and gear-shift gaiter	-	●	●	●	£625.00	£750.00



Audi Complete

Audi Complete is simply a way to look after the servicing and maintenance costs for your Audi in a single package. You pay a one-off or monthly fee and we'll cover all your servicing and maintenance costs for the next 3 years. It includes replacement parts, tyres and your first MOT, as well as a full 5-year warranty. It means you only have to pay for fuel, insurance and your Road Fund Licence. So you can be reassured that your car will be maintained by trained Audi Technicians, using genuine Audi parts.

*Retail customers only. Pricing based on 3 years/30,000 miles (whichever occurs sooner). All pricing is a 'starting from' price for the Audi A5 Cabriolet model range and is therefore subject to change and mileage/model dependent.

Warranty

Options are subject to availability and may extend delivery.

- = Not available
• = Available
S = Standard

**Only available prior to registration of your new A5 Cabriolet. Please speak to your Audi Centre for full details.

RRP - Recommended Retail Price.

VAT is calculated at 20% but this may alter to reflect any change in the applicable VAT rate.

Order Code			A5 Cabriolet	S5 quattro	Basic RRP	Total RRP inc VAT
AC1	Audi Complete – Service, Maintenance and 5-year warranty. Comprehensive care for your Audi covering all your servicing and maintenance for 3 years, as well as your first MOT and a full 5-year/90,000 mile warranty. Visit audi.co.uk/audicomplete for full details including terms and conditions	Monthly Direct Debit	•	–	£33.33	£40.00*
			–	•	£41.67	£50.00*
AC2	Audi Complete – Service, Maintenance, Tyres and 5-year warranty. Comprehensive care for your Audi covering all your servicing, maintenance and tyres for 3 years, as well as your first MOT and a full 5-year/90,000 mile warranty. Visit audi.co.uk/audicomplete for full details including terms and conditions	Monthly Direct Debit	•	–	£42.50	£51.00*
			–	•	£64.17	£77.00*

Order Code			A5 Cabriolet	S5 quattro	Basic RRP	Total RRP inc VAT
-	Audi Warranty , covering you for unlimited mileage in the first two years of ownership, and up to 60,000 miles in the third year. Transferable between owners**		S	S	No charge	No charge
EA6	Audi Warranty , covering you for up to 4 years or 75,000 miles, whichever comes soonest. Cover includes a two-year unlimited mileage warranty, and up to 75,000 miles in the third and fourth years. Transferable between owners**		•	•	£445.83	£535.00
EA9	Audi Warranty , covering you for up to 5 years or 90,000 miles, whichever comes soonest. Cover includes a two-year unlimited mileage warranty, and up to 90,000 miles in the third, fourth and fifth years. Transferable between owners**		•	•	£1,045.83	£1,255.00

Merchandise

From the enthusiasts' motorsport collection to the sophisticated Audi collection, there's a wide variety of adults' and children's clothing, lifestyle accessories and collectables, all of which bear the Audi name.

Please speak to a member of our team at your local Audi Centre to see the full Audi collection and to place an order. A selection of Audi merchandise is also available to buy from audi.co.uk/merchandise.



Audi kids



Bags and leather goods



Clothing



Motorsports



Sport and travel



Model cars

Accessories

Choosing an Audi isn't just a matter of deciding on the model you want; it's about creating a car that suits your needs perfectly. And that's why we've developed a whole range of accessories to enhance your A5 Cabriolet, enabling you to customise it down to the last detail. Like your Audi, all these accessories are developed to the highest possible standards. They're all available exclusively from Audi.

To find out more, just visit audi.co.uk/accessories or contact your local Audi Centre.

Warranty

All of the accessories available on the A5 Cabriolet are covered by a three-year warranty* if they are ordered and included in the purchase price of the car at date of delivery. Any accessories ordered and installed after delivery include a two-year warranty.*



Sport and design



Transport and touring

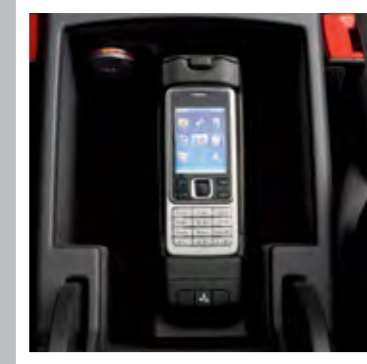

Entertainment and communication



Comfort and protection

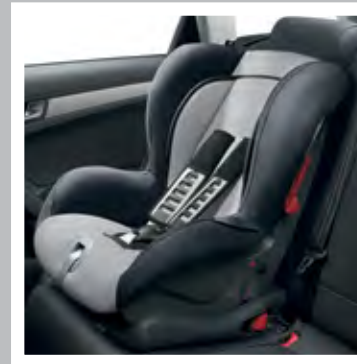

Family



Safety and security

*Excluding Road Angel products. Audi Accessories warranty terms and conditions can be found at audi.co.uk

A5 Cabriolet Petrol technical data

Engine	1.8 TFSI	1.8 TFSI	2.0 TFSI	2.0 TFSI	2.0 TFSI quattro	3.0 TFSI quattro
Transmission	6-speed manual	multitronic	6-speed manual	multitronic	7-speed S tronic	7-speed S tronic
Cylinder	4-cylinder	4-cylinder	4-cylinder	4-cylinder	4-cylinder	6-cylinder
Displacement, cubic cm (valves per cylinder)	1798	1789	1984	1984	1984	2995
Max. power ¹ , PS	170	170	211	211	211	272
Max. torque, Nm at rpm	320/1400-3700	320/1400-3700	350/1500-4200	350/1500-4200	350/1500-4200	400/2150-4780
0-62mph acceleration, seconds	8.7	8.9	7.5	7.6	7.3	6.3
Top speed, mph	138	132	150	145	148	150
CO ₂ emissions ² , g/km	143	143	154	149	164	199
Benefit in kind (BIK)%	19%	19%	21%	20%	23%	30%
Fuel consumption ² , mpg (l/100km) Urban	35.8 (7.9)	39.2 (7.2)	32.8 (8.6)	36.2 (7.8)	32.1 (8.8)	25.2 (11.2)
Fuel consumption ² , mpg (l/100km) Extra Urban	55.4 (5.1)	50.4 (5.6)	52.3 (5.4)	50.4 (5.6)	46.3 (6.1)	40.9 (6.9)
Fuel consumption ² , mpg (l/100km) Combined	45.6 (6.2)	45.6 (6.2)	42.8 (6.6)	44.1 (6.4)	39.2 (7.2)	33.2 (8.5)
ABI insurance group 1-50*	29E	29E	32E	33E	34E	40E
Unladen weight ³ , kg	1620	1655	1630	1660	1735	1850
Gross weight limit, kg	2120	2155	2130	2160	2235	2350
Roof load limit/Nose weight, kg	80	80	80	80	80	80
Max trailer load ⁴ unbraked, kg	750	750	750	750	750	750
Max trailer load ⁴ with 12% gradient, kg	1500	1300	1500	1500	1700	1900
Max trailer load ⁴ with 8% gradient, kg	1700	1500	1700	1700	1900	2100
Luggage compartment capacity, litres, seats folded up/down	380/750	380/750	380/750	380/750	380/750	380/750
Fuel tank capacity approx, litres	63	63	63	63	61	61

*Highest insurance group rating shown. Group may be lower dependent on trim level. Please visit www.thatcham.org/abigrouprating for details.

All diesel engines are fitted with a Diesel Particulate Filter.

¹The given value was obtained in accordance with the specified measurement procedure (the respective current version of the Directive 80/1269/EEC).

²Fuel consumption and CO₂ emissions figures are obtained under standardised test conditions (Directive 93/116/EEC) using a representative model. This allows direct comparison between different models from different manufacturers, but may not represent the actual fuel consumption achieved in 'real world' driving conditions. More information is available at www.vca.gov.uk.

³Vehicle's unladen weight without driver (calculated in accordance with the current version of Directive 80/1268/EEC). The fitting of additional equipment may increase the vehicle's unladen weight and drag coefficient, whereupon the potential carrying capacity and top speed will be correspondingly reduced.

⁴The engine's power output always goes down with increasing altitude. At 1,000m above sea level, and for every additional 1,000m, deduct 10% from the weight of the outfit (trailer load limit + gross weight of the towing vehicle).

Please note: The maximum power output figures are quoted in PS (or Pferdestärke, which is the metric equivalent of brake horsepower). To convert to brake horsepower, divide the PS figure by 1.0139.

A5 Cabriolet Diesel technical data

Engine	2.0 TDI	2.0 TDI	2.0 TDI	2.0 TDI quattro	3.0 TDI	3.0 TDI quattro
Transmission	6-speed manual	6-speed manual	multitronic	6-speed manual	multitronic	7-speed S tronic
Cylinder	4-cylinder	4-cylinder	4-cylinder	4-cylinder	V6	V6
Displacement, cubic cm (valves per cylinder)	1968	1968	1968	1968	2967	2967
Max. power ¹ , PS	143	177	177	177	204	245
Max. torque, Nm at rpm	320/1750-2500	380/1750-2500	380/1750-2500	380 / 1750 – 2500	400/1250-3500	500/1400-3250
0-62mph acceleration, seconds	10.2	8.8	8.3	8.5	7.6	6.3
Top speed, mph	130	138	137	137	143	155
CO ₂ emissions ² , g/km	126	127	132	142	138	154
Benefit in kind (BIK)%	19%	19%	20%	22%	21%	24%
Fuel consumption ² , mpg (l/100km) Urban	49.6 (5.7)	48.7 (5.8)	48.7 (5.8)	43.5 (6.5)	48.7 (5.8)	40.4 (7.0)
Fuel consumption ² , mpg (l/100km) Extra Urban	65.7 (4.3)	64.2 (4.4)	61.4 (4.6)	57.9 (4.9)	57.6 (4.9)	54.3 (5.2)
Fuel consumption ² , mpg (l/100km) Combined	58.9 (4.8)	57.6 (4.9)	56.5 (5.0)	52.3 (5.4)	54.3 (5.2)	47.9 (5.9)
ABI insurance group 1-50*	27E	30E	30E	31E	33E	39E
Unladen weight ³ , kg	1655	1655	1680	1720	1760	1845
Gross weight limit, kg	2155	2155	2180	2220	2260	2345
Roof load limit/Nose weight, kg	80	80	80	80	80	80
Max trailer load ⁴ unbraked, kg	750	750	750	750	750	750
Max trailer load ⁴ with 12% gradient, kg	1600	1600	1700	1700	1900	1900
Max trailer load ⁴ with 8% gradient, kg	1800	1800	1900	1900	2100	2100
Luggage compartment capacity, litres, seats folded up/down	380/750	380/750	380/750	380/750	380/750	380/750
Fuel tank capacity approx, litres	63	63	63	61	63	61

*Highest insurance group rating shown. Group may be lower dependent on trim level. Please visit www.thatcham.org/abigrouprating for details.

¹The given value was obtained in accordance with the specified measurement procedure (the respective current version of the Directive 80/1269/EEC).

²Fuel consumption and CO₂ emissions figures are obtained under standardised test conditions (Directive 93/116/EEC) using a representative model. This allows direct comparison between different models from different manufacturers, but may not represent the actual fuel consumption achieved in 'real world' driving conditions. More information is available at www.vca.gov.uk.

³Vehicle's unladen weight without driver (calculated in accordance with the current version of Directive 80/1268/EEC). The fitting of additional equipment may increase the vehicle's unladen weight and drag coefficient, whereupon the potential carrying capacity and top speed will be correspondingly reduced.

⁴The engine's power output always goes down with increasing altitude. At 1,000m above sea level, and for every additional 1,000m, deduct 10% from the weight of the outfit (trailer load limit + gross weight of the towing vehicle).

Please note: The maximum power output figures are quoted in PS (or Pferdestärke, which is the metric equivalent of brake horsepower). To convert to brake horsepower, divide the PS figure by 1.0139.

S5 Cabriolet technical data

Engine	S5 quattro
Transmission	7-speed S tronic
Cylinder	V6
Displacement, cubic cm (valves per cylinder)	2995
Max. power ¹ , PS	333
Max. torque, Nm at rpm	440/2900 - 5300
0-62mph acceleration, seconds	5.4
Top speed, mph	155
CO ₂ emissions ² , g/km	199
Benefit in kind (BIK)%	30%
Fuel consumption ² , mpg (l/100km) Urban	25.2 (11.2)
Fuel consumption ² , mpg (l/100km) Extra Urban	40.9 (6.9)
Fuel consumption ² , mpg (l/100km) Combined	33.2 (8.5)
ABI insurance group 1-50*	42E
Unladen weight, ³ kg	1880
Gross weight limit, kg	2380
Roof load/Nose weight, kg	80
Max trailer load unbraked, ⁴ kg	750
Max trailer load with 12% gradient, ⁴ kg	1900
Max trailer load with 8% gradient, ⁴ kg	2100
Luggage compartment capacity, litres, seats folded up/down	380/750
Fuel tank capacity approx, litres	61

*Highest insurance group rating shown. Group may be lower dependent on trim level. Please visit www.thatcham.org/abigrouprating for details.

¹The given value was obtained in accordance with the specified measurement procedure (the respective current version of the Directive 80/1269/EEC).

²Fuel consumption and CO₂ emissions figures are obtained under standardised test conditions (Directive 93/116/EEC) using a representative model. This allows direct comparison between different models from different manufacturers, but may not represent the actual fuel consumption achieved in 'real world' driving conditions. More information is available at www.vca.gov.uk.

³Vehicle's unladen weight without driver (calculated in accordance with the current version of Directive 80/1268/EEC). The fitting of additional equipment may increase the vehicle's unladen weight and drag coefficient, whereupon the potential carrying capacity and top speed will be correspondingly reduced.

⁴The engine's power output always goes down with increasing altitude. At 1,000m above sea level, and for every additional 1,000m, deduct 10% from the weight of the outfit (trailer load limit + gross weight of the towing vehicle).

Please note: The maximum power output figures are quoted in PS (or Pferdestärke, which is the metric equivalent of brake horsepower). To convert to brake horsepower, divide the PS figure by 1.0139.



A5 Cabriolet dimensions

The technical drawings opposite show the exact dimensions of the Audi A5 Cabriolet, so you can check everything - from whether the car will fit in your garage to whether your luggage will fit in the boot.

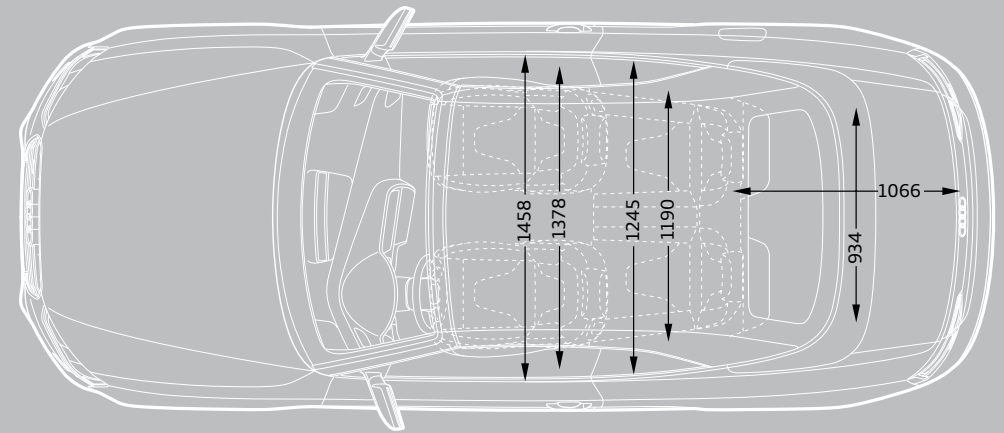
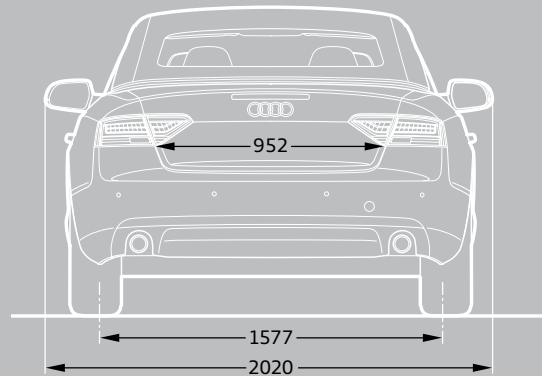
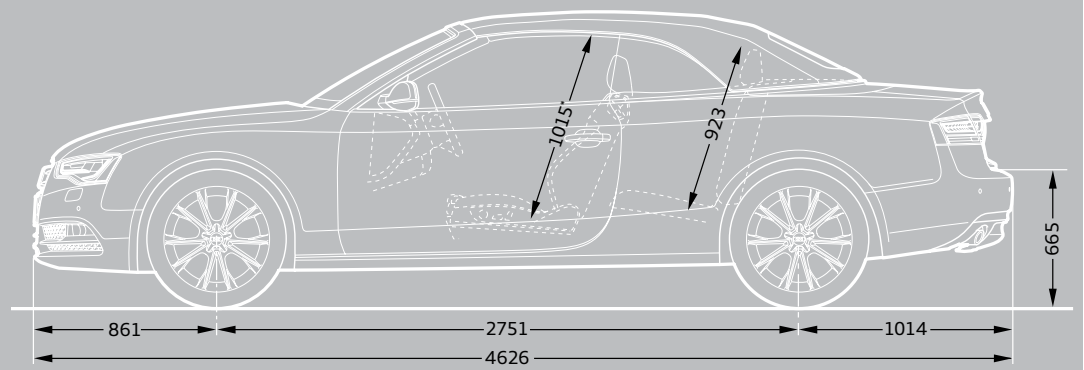
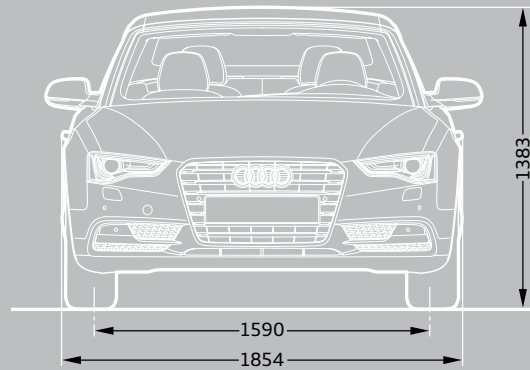

*Maximum headroom.

Dimensions were measured with vehicle at unladen weight, ground clearance measured with vehicle carrying its maximum load.

Luggage compartment volume in litres: 320 with hood open, 360 with hood closed, 750 with rear seats folded (measured by the VDA standard test method using 200 x 100 x 50 mm blocks; second value: with rear seat folded down).

Turning circle approx 11.4m.

Dimensions in millimetres.

S5 Cabriolet dimensions

The technical drawings opposite show the exact dimensions of the Audi S5 Cabriolet, so you can check everything – from whether the car will fit in your garage to whether your luggage will fit in the boot.

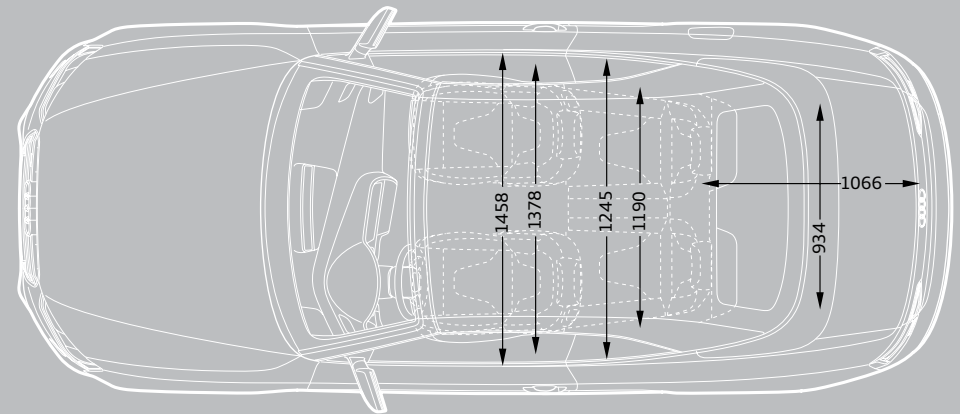
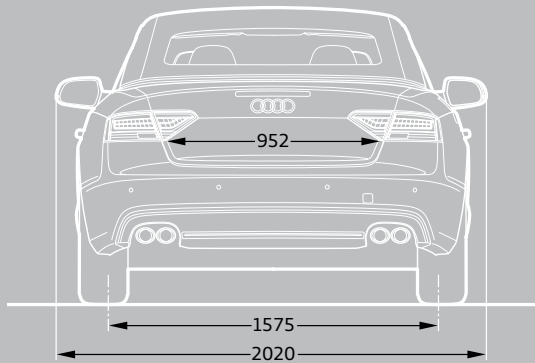
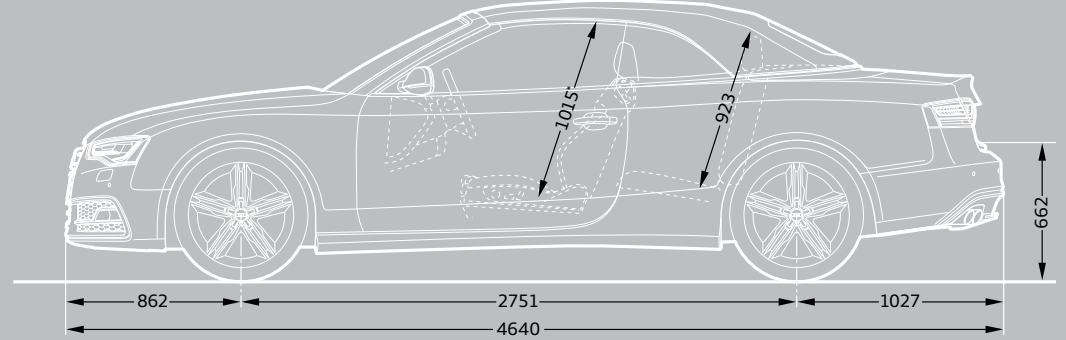
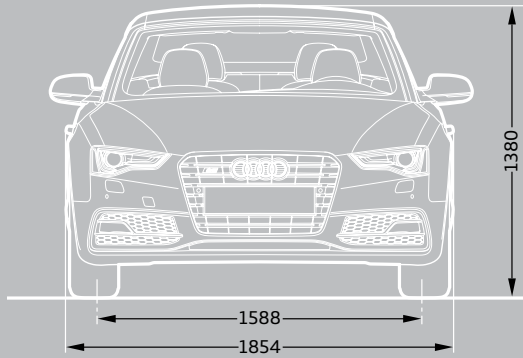

*Maximum headroom.

Dimensions were measured with vehicle at unladen weight, ground clearance measured with vehicle carrying its maximum load.

Luggage compartment volume in litres: 320 with hood open, 360 with hood closed, 750 with rear seats folded (measured by the VDA standard test method using 200 x 100 x 50 mm blocks; second value: with rear seat folded down).

Turning circle approx 11.4m.

Dimensions in millimetres.

Additional information

CO₂ data and information

CO₂ emissions-based Vehicle Excise Duty

Vehicle Excise Duty (Road Fund Licence) is based upon the amount of Carbon Dioxide (CO₂) a vehicle emits, measured in grams per kilometre (g/km). First year VED rates apply to the first year of ownership. Annual VED rates apply thereafter. The DVLA has created thirteen categories:

Petrol and Diesel engines	First year	Annual rate (second year onwards)
A – up to 100g/km	£0.00	£0.00
B – 101 to 110g/km	£0.00	£20.00
C – 111 to 120g/km	£0.00	£30.00
D – 121 to 130g/km	£0.00	£100.00
E – 131 to 140g/km	£120.00	£120.00
F – 141 to 150g/km	£135.00	£135.00
G – 151 to 165g/km	£170.00	£170.00
H – 166 to 175g/km	£275.00	£195.00
I – 176 to 185g/km	£325.00	£215.00
J – 186 to 200g/km	£460.00	£250.00
K – 201 to 225g/km	£600.00	£270.00
L – 226 to 255g/km	£815.00	£460.00
M – over 255g/km	£1,030.00	£475.00

Vehicle Excise Duty (VED) rates correct at time of going to print, but these may alter to reflect any change in the applicable VED rate.

Servicing tailored to your needs

Regular servicing is key to safeguarding your Audi's performance and a full Audi service history could help you preserve the future re-sale value. To make servicing easy, the Audi Service Schedules have been designed to work with your individual driving style and vehicle.

There are two schedules available and your Audi Centre will advise which schedule is most suited to your needs. The conventional fixed Audi Inspection Service schedule has fixed intervals for the Oil-change and Inspection Service that are based on time and distance, whichever comes first.

With the Audi LongLife Service schedule, sensors take account of driving style and conditions in which the vehicle is used to indicate when the Oil-change Service is required. Oil-change Service intervals are therefore variable and are conveniently indicated via the on-board service interval display.

Audi Complete

When selecting the option of Audi Complete your vehicle should be placed on the following service schedules dependent on your mileage per annum:

- ▶ Under 10,000 miles per annum – Fixed Inspection Service Schedule
- ▶ Over 10,000 miles per annum – LongLife Service Schedule

Fixed Inspection Service Schedule

	Vehicle usage:
Mileage	Less than 10,000 miles per annum
Type of journey	Mainly city/town centre driving. Short journeys
Conditions	Frequent cold starts. High engine loading – e.g. frequent hill climbs, vehicle fully loaded, towing
Driving style	Uneconomical – e.g. heavy acceleration, heavy braking, constant changes in speed, constant use of high revs, 'sporty' driving
	Service Intervals:
Oil-change Service	Fixed to every 9,000* miles/1 year
Inspection Service	Fixed to every 19,000* miles/2 years

Variable LongLife Service Schedule

	Vehicle usage:
Mileage	More than 10,000 miles per annum
Type of journey	Motorway and main road driving. Mainly longer distance journeys. Constant speeds
Conditions	Normal engine loading – e.g. with little or no towing, with little or no hill climbs. Normal vehicle loading
Driving style	Moderate acceleration, moderate braking, engine revs mainly below 3,000
	Service Intervals:
Oil-change Service	Variable to a maximum of every 19,000* miles/2 years
Inspection Service	Fixed to every 19,000* miles/2 years

*As indicated by the service interval display. Mileages are approximate as the Service Indicator system uses kilometres as its distance measurement.

Additional information

Welcome to Audi

By placing an order for your Audi, you're choosing to get behind the wheel of one of the most sophisticated cars on the road. And because we believe the service we offer should be just as advanced, we wanted to let you know exactly what you can expect from us, now and in the future.

We've agreed a set of standards with all our Centres, which governs the way we do business with you. It outlines the kind of service we promise to deliver for every customer, right down to filling each new Audi we sell with half a tank of fuel.

So whether you're interested in the date your car will arrive in the UK or the way we'll dispose of non-biodegradable materials after we service your Audi, you can have total confidence in us.

Audi Promise

Audi Centres

We guarantee that all of our Centres will be open as follows:

Sales: Monday to Friday 9am–6pm
Saturday 9am–5pm

Service: Monday to Friday 8am–6pm
Saturday 8.30am–1pm

Sunday opening is at local discretion.

New car delivery

Once we've confirmed a delivery date for your car, we'll keep you informed of progress. Subject to reasonable notice, we'll then deliver it to a place of your choice, whether that's your home or place of work. In the unlikely event of a delay, we'll provide a courtesy car to minimise inconvenience and keep you mobile.

The experts in Vorsprung durch Technik

Would you entrust your Audi to anyone who hasn't been regularly trained to Audi standards? Our network of Audi Approved Master Technicians have undergone an impressive 100,000 hours of training over a 10-year programme to ensure they have the latest technical expertise for maintaining and servicing your Audi. All of our Service Advisors undergo a specialist induction and training to ensure they are Audi professionals and able to talk to you about any issues you may have with your Audi vehicle. What's more, we have so much expertise and experience in looking after Audi vehicles that we are able to make a note of your mileage and the state of your vehicle as and when we see it and predict when certain key events may occur. As part of our commitment to you, we will notify you in plenty of time so you can make an appointment with us.

Your convenience comes first

At Audi you can choose from a range of convenient services that suit your needs. Why not book a 'service while you wait' appointment* and enjoy our complimentary refreshments while your car is with us? Or, if you need to be mobile, take advantage of one of our courtesy cars which we can even collect and deliver to you.* We guarantee we can service your Audi within 5 days without a courtesy car, or within 10 days if you need transport. We will also ensure your car is returned to you with a full valet.

Audi Genuine Parts

Would you put a part into your Audi that wasn't the same quality as the factory fitted original? You can rest assured that only Audi Genuine Parts will be used on your vehicle. What's more, Audi parts and labour come with a 2-year guarantee.** We stock a wide variety of parts, so we are well covered. However, if we don't have a part in stock at our Centre we have the back-up of parts at other Audi Centres, at our national warehouse and our factory and can usually source the relevant part very quickly.

We don't like surprises either

We believe strongly in transparency and there will be no hidden costs. For added peace of mind, we will give you a quotation over the phone for the work you have requested and email you the price confirmation. We'll consult you if any additional work on your car is needed when it is with us. We won't carry out any extra work without asking your permission first.

The Audi Stamp

Regular servicing is key to safeguarding your Audi's performance and a full Audi service history could help you preserve the future re-sale value of your car. Only the Audi Stamp will prove your approved Audi service history.

Getting better every time

We continually gather feedback from our Audi Trained Technicians, as well as our customers, to ensure our vehicles are running as they should. Whenever we see an Audi for a service, we connect it directly to our headquarters in Ingolstadt which enables us to check your car's software and make sure it's as up-to-date as possible. If the factory has released a software upgrade for your model, it can be applied immediately – improving anything from your car's efficiency to the precision of its parking system.

Environmental commitment

We promise to dispose of all non-biodegradable materials from your vehicle in a responsible manner.

*Subject to availability.

**Excludes wear and tear.

Pricing information

Pricing

Prices and specifications given are correct at the time of printing. Always check details with your Audi Centre, as Audi policies are continually developing. We reserve the right to change prices or specifications at any time.

All prices are subject to VAT, currently charged at 20% but this may alter to reflect any change in the applicable VAT rate.

Delivery charges and number plates are not included in the vehicle price.

Delivery charge	£471.66
Number plate	£20.00
VAT	£98.34
Total	£590.00

Audi Roadside Assistance

Your new car comes complete with 3 years' complimentary roadside assistance and recovery across the UK provided by RAC Motoring Services. Also included is roadside assistance throughout Europe, managed by RAC Motoring Services.

For further information and terms and conditions please visit audi.co.uk

Audi Customer Care

Every new Audi benefits from the comprehensive Audi Customer Care Package, which comprises:

- ▶ A 3-year Audi warranty, which covers you for unlimited mileage in the first 2 years of ownership, with a full mechanical and electrical warranty which covers you for up to 60,000 miles in the 3rd year

- ▶ A 3-year paint warranty
- ▶ A 12-year anti-corrosion warranty
- ▶ 3 years' UK roadside assistance and recovery

You also have the option when ordering your new car of choosing a 4-year or 5-year Audi warranty. Speak to a member of the sales team for more information.

Audi Tax-Free Sales

If you are entitled to purchase a vehicle free of VAT, normally through Military or Diplomatic privilege, please contact your local Audi Centre for full details.

Should you have any difficulty obtaining the information you require, please call Freephone 0800 585878.

Audi Finance

Audi Finance specialise in providing funding solutions for Audi drivers. Whether your Audi is for private or business use, there are a range of funding options to choose from.

Below is the full range of finance products.

- ▶ Solutions – a Personal Contract Plan
- ▶ Hire purchase
- ▶ Lease purchase
- ▶ Finance lease
- ▶ Contract hire

With all products, you can choose a fixed-cost maintenance plan designed to help you budget accurately.

No matter what Audi model you choose, your local Audi Centre can provide you with a personalised quote which could fit your budget and motoring needs.

Audi Finance is a trading name of Volkswagen Financial Services (UK) Limited. An offer of finance depends on certain conditions. Available to people over 18 in the UK only.

Audi Insurance

We want you to start enjoying your new car from day one and thanks to Audi Insurance complimentary seven day cover, you can. Call free on 0800 316 7893 (lines are open Monday to Friday 8am - 9pm, and Saturday 9am - 5pm), provide a few details and a cover note will be sent to your Audi Centre. They will then tax your car and you can drive it away.

Audi Insurance is a trading name of Volkswagen Insurance Service (Great Britain) Limited, an appointed representative of Volkswagen Financial Services (UK) Limited, Brunswick Court, Yeomans Drive, Blakelands, Milton Keynes MK14 5LR. Registered in England number 2835230. Audi Insurance is sold, underwritten and administered by Allianz Insurance plc registered in England number 84638. Registered office 57 Ladymead, Guildford, Surrey GU1 1DB. Volkswagen Financial Services (UK) Limited and Allianz Insurance plc are authorised and regulated by the Financial Services Authority. Volkswagen Financial Services (UK) Limited and Allianz Insurance plc are not part of the same corporate group.

Audi UK

Customer Services
Selectapost 29
Sheffield
S97 3FG
0800 699888
audi.co.uk

Specifications and prices subject
to change without notice.

© Audi UK

Printed in the UK
Edition 7.1 06/12
2013 model year

Images are for illustrative purposes only.

