



The Audi A8 and S8

Pricing and Specification Guide
Valid from June 2012

Personalising your Audi A8

This guide has been designed to help you tailor and price your Audi A8 quickly and logically. At the back, you will find information on CO₂ emissions-based taxation and the other services offered by Audi, including Finance and Insurance. You can also configure your Audi A8 online at audi.co.uk.

You might also like to consider Audi Complete: a simple way to take care of servicing and maintenance costs for your Audi in a single package. You pay a one-off or monthly fee and we'll cover all your servicing, maintenance and tyres for the next three years, including your first MOT and a full 5-year warranty. It means you only have to pay for fuel, insurance and your Road Fund Licence. So you can be reassured that your car will be maintained by trained Audi Technicians, using genuine Audi parts.

Audi Complete™

The Audi A8

Engines	8
Transmission	9
quattro®	10
Efficiency	12

Model details and prices

SE model equipment	14
SE Executive model equipment	18
Long wheelbase model equipment	19
S8 model equipment	20
W12 long wheelbase model equipment	22
Model prices	24

Audi exclusive

Colour and upholstery

Paint	28
Upholstery and seats	30
Colour and trim guide	38
Packages and special parts	42
Inlays	44

Options

Interior design	46
Audi design selection	48
Wheels, tyres and suspension	50
Audio and communication	54
Safety and security	56
Interior equipment	60
Exterior equipment	62
Steering wheels	64
Audi Complete and Service plan	66
Warranty	67
Merchandise	68

Technical details

Technical data	69
Dimensions	71
Additional information	74
Pricing information	76





Vorsprung durch Technik

Three words that express the very essence of Audi. Vorsprung durch Technik isn't a slogan. It's our way of seeing the world. It is the driving force behind our history of innovation that continues into the 21st century. Indeed, many technologies that Audi pioneered remain in our cars today. Some are milestones in the history of the motorcar.

From our beginnings in 1899, to the Auto Union team's Grand Prix successes in the 1930s and our more recent wins at Le Mans, we have always been at the forefront of the motor industry.

Vorsprung durch Technik makes us who we are. To see more of its influence, just read on.

The Audi A8 – state-of-the-art luxury

As you might expect at the top of the range, the Audi A8 combines timeless elegance with the latest Audi innovations. It has a high level of luxury, thanks to exquisite attention to detail and extensive specifications as standard – adaptive air suspension, luxurious seats upholstered in Valcona leather, Audi Music Interface and HDD-based navigation including MMI Touch®

There's also pre-sense basic, which provides you with comprehensive preventive protection. This advanced safety system can detect an imminent collision and tighten the seat belts, close the sunroof and windows, and activate the hazard warning lights to alert other drivers.

You'll also be able to take advantage of predictive route data as standard, which links to our HDD Satellite Navigation system to identify bends, junctions and motorway stretches. The system then adjusts the transmission, lights and even the adaptive cruise control (if fitted) to provide optimum safety and comfort.

The Audi A8 is built on the aluminium Audi Space Frame®. Along with high-performance engines such as the 3.0 TDI® and 4.2 TDI®, it's helped to reduce CO₂ emissions by approximately 20% across the Audi A8 range. And, of course, you'll benefit from even more miles per gallon. With its refined comfort and sophisticated technologies like optional night vision, the Audi A8 is how Audi sees twenty-first century luxury car travel.





Engines

Petrol

FSI® direct-injection technology is a unique Audi innovation that was originally developed for the Le Mans 24-hour endurance race to deliver more power and torque, as well as enhanced fuel efficiency. Precisely the right amount of fuel and air are injected into the combustion chambers, enabling the engine to ‘breathe’ more easily. It results in reduced heat loss and increased output, with around a 15% reduction in fuel consumption and significantly lower exhaust emissions. For the A8 we’ve also developed TFSI®, which combines supercharging with FSI technology, giving cars an extra injection of power.

Diesel

We introduced TDI® to the roads in 1989, marking a departure from the noisy, fuel-thirsty diesel engines of the past. The Audi A8’s 4.2 TDI® engine uses common-rail technology to produce more power, as well as increasing efficiency. Under this system, a series of piezo injectors use electrical charge to precisely control the amount of fuel injected into the engine. As well as reducing noise, this allows combustion to happen at a lower temperature, with less oxygen, which cuts down emissions.





Transmission

8-speed tiptronic®

The Audi A8 comes with an advanced 8-speed tiptronic® transmission system which reduces both fuel consumption and CO₂ emissions. It converts high-torque engine power into both sporty performance and operating convenience, with crisp, fast gear changes, reduced weight and an optimised gearshift strategy. More spontaneous gear changes are a particular benefit, especially when downshifting. Both in the 'D' (Drive) and 'S' (Sport) programme, the advanced electronics used in tiptronic® respond efficiently to every driver input, helping to prevent unwanted upshifts when cornering. Furthermore, this advanced gearbox can be operated entirely in manual mode, enabling the driver to change gear using the paddles, located on the steering wheel.

quattro®

It's the technology that has given Audi the edge on the rally circuit ever since it was first introduced over 30 years ago – a technology that delivers ultimate control whilst enhancing the sporty characteristics which make the Audi A8 so thrilling to drive. It's called quattro® permanent all-wheel-drive. The principle is simple: in the same way that four brakes ensure better deceleration, four permanently-driven wheels deliver better acceleration and road-holding, pushing or pulling the car as needed, for a driving experience that's both dynamic and safe.

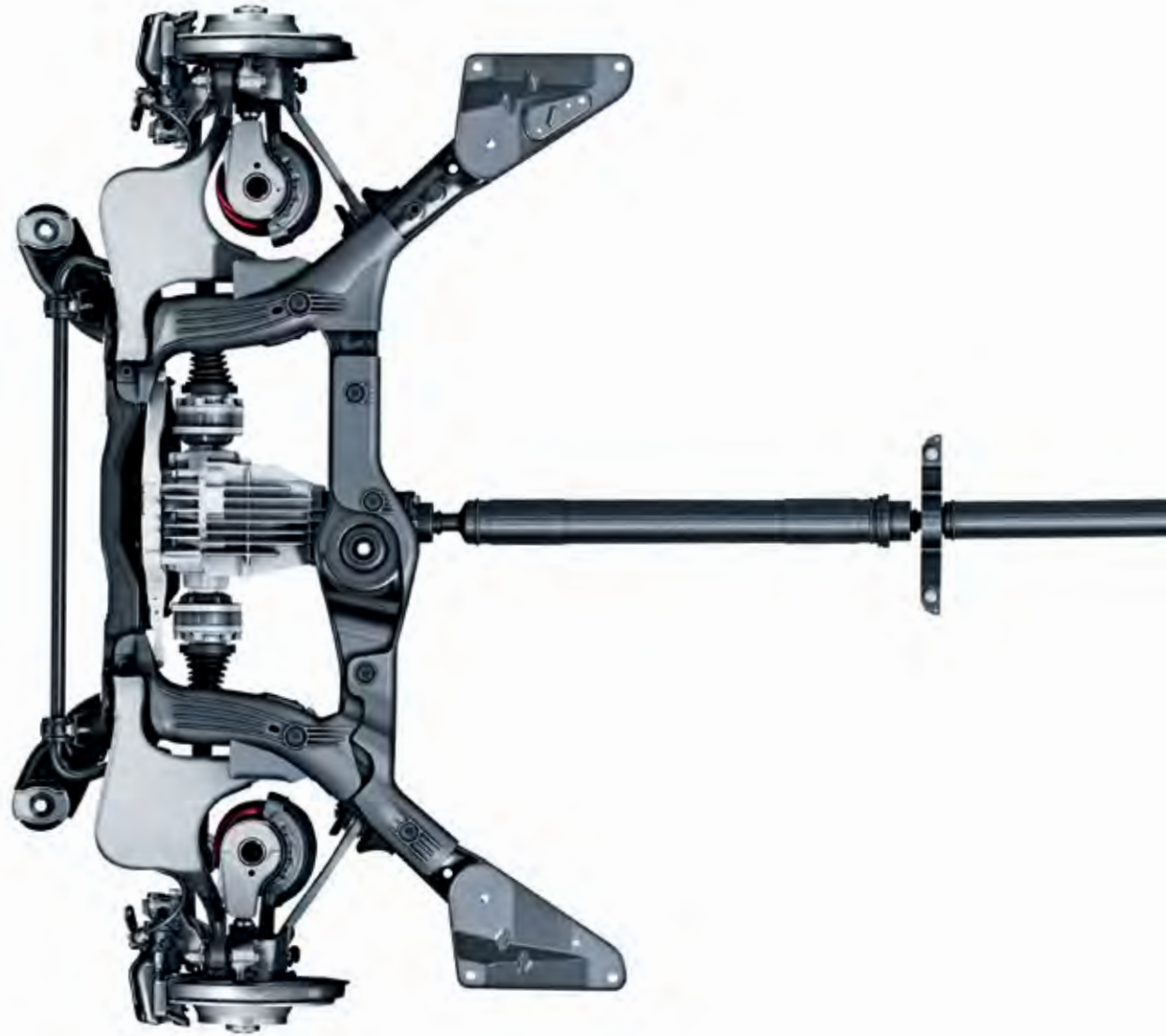

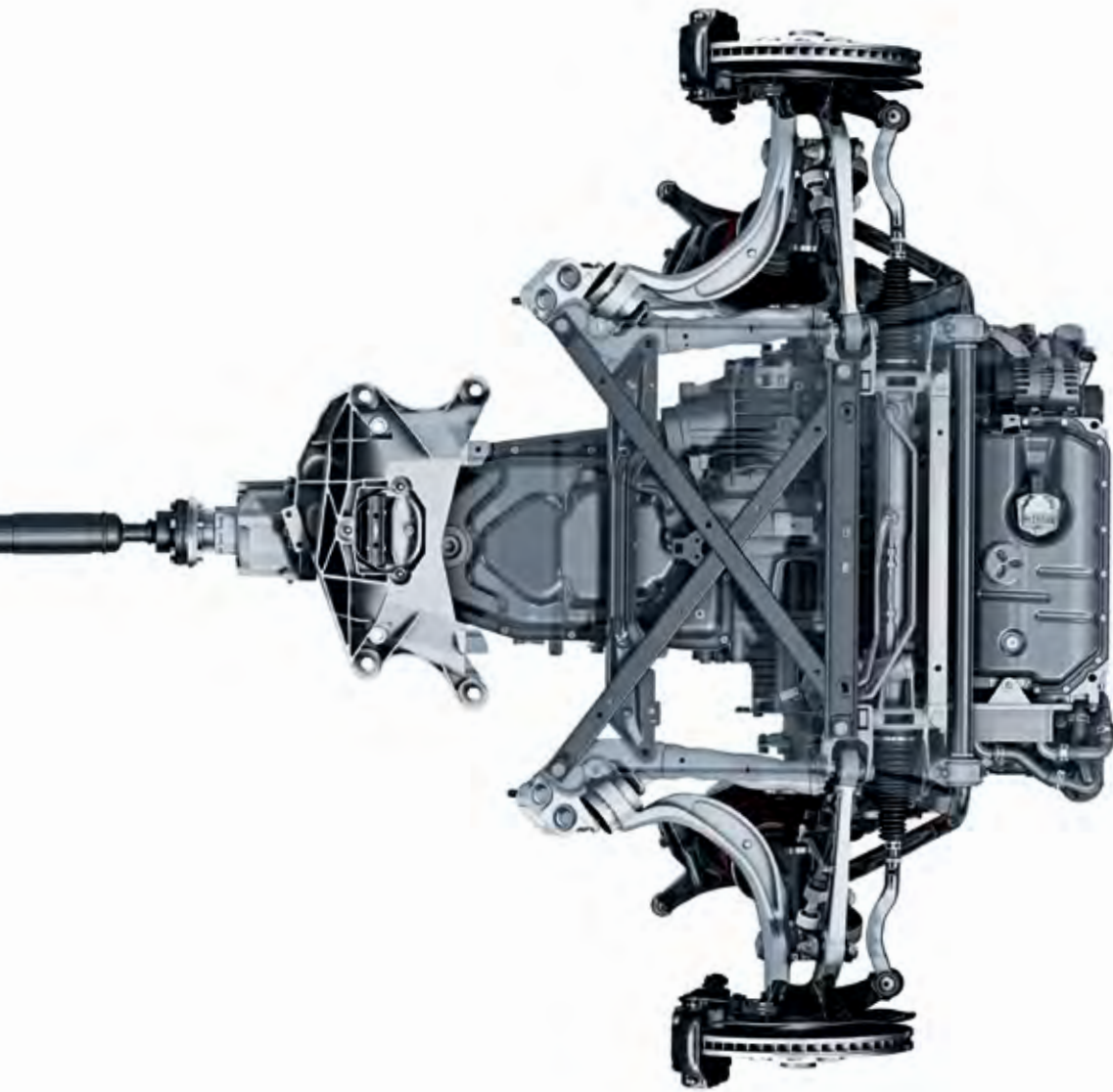

In the Audi A8, asymmetric dynamic torque distribution continuously distributes drive power between the front and rear axles, depending on weather conditions, road surface and gradient. This leads to greater flexibility and an enhanced, sportier drive.

What's more, with the 4.2-litre TDI® engine and on the Audi S8, you'll get quattro with Sports differential as standard. Put simply, this delivers more stability and an even more dynamic driving experience, especially on tight corners or when there is a weight shift under heavy braking.

Efficiency

At Audi, doing less is something we're trying to do more of. We're working to use less fuel, release less CO₂ and waste less energy. It's why we've incorporated a number of more efficient technologies into the Audi A8.

Aerodynamics

A car's shape can have a big impact on its efficiency. It's why we've worked to make the A8 as aerodynamic as possible. By including technology such as adaptive air suspension that responds to changes in speed, we've ensured it has the lowest drag coefficient in its class. It means that the A8 becomes more aerodynamic at high speeds, while still offering an exceptional ride quality.

TDI® and FSI®

Inside the engine of the Audi A8 you'll find the same advanced fuel-injection technology that's driven us to win after win at Le Mans. With TDI® and FSI®, fuel is injected directly into the engine's chambers so that combustion is timed right down to the millisecond. As a result, waste is minimised and you get the most from every last drop of fuel.





Audi Space Frame®

The Audi Space Frame® gives the Audi A8 perfect balance on the road. As well as providing protection, its lightweight construction also allows the A8 to accelerate faster and release fewer CO₂ emissions.

Automatic Start-Stop function

In heavy traffic, your car still uses fuel and releases CO₂, even when it's stationary. The automatic Start-Stop function counteracts this problem by switching off the engine when your car comes to a standstill. As soon as you release the brake pedal, the car restarts. On the 3.0 TDI, for example, this could save up to 0.4 litres of fuel every 100km.

Recuperation

With a recuperation system like the one in the Audi A8, the kinetic energy used in braking is converted into useful electrical energy. This results in a fuel saving of up to 3%.

Audi cylinder-on-demand

High performance does not necessarily equate to higher consumption – as the engine of the new S8 proves. Using advanced cylinder-on-demand technology to automatically shut down four of the eight cylinders when they are not required, particularly in city traffic, you benefit from the efficiency and low emissions of a car with a much smaller engine. Out on the open road meanwhile, the unbridled and instantaneous power of the turbocharged V8 is ready and waiting.

SE model equipment

All A8 SE models have the following items of standard equipment

Engine and transmission

8-speed tiptronic transmission with electronically-transmitted shift information and Dynamic Shift Programme (DSP)

Recuperation for optimal energy utilisation

Automatic Start-Stop function for greater fuel and CO₂ efficiency. Includes energy saving tips in Driver's Information System

Wheels, tyres and suspension

18" x 8J '7-arm' design alloy wheels with 235/55 R18 Y tyres

Adaptive air suspension with four selectable modes (Auto, Dynamic, Comfort and Lift) selectable through MMI

Audi drive select with four pre-configured modes (Comfort, Auto, Dynamic and Efficiency)

Locking wheel bolts

quattro permanent all-wheel-drive*

Space-saver spare wheel

Seats

Valcona leather

Electrically-adjustable 4-way lumbar support

Electric front seats with memory (12-way adjustable), including adjustment for:

- forward/backwards position
- seat cushion height
- seat cushion tilt
- backrest
- seat-belt height
- head rest
- Memory for driver's seat, passenger seat, steering wheel and door mirror

Heated front seats with variable temperature adjustment

Audio and communication

Audi Music Interface (AMI) – Universal connection for use with stereo audio sources, USB and MP3 devices including Apple iPod generation 4 onwards (iPod, iPod classic, iPod mini, iPod nano, iPod photo, iPod video, iPod touch). Provides intuitive control through the audio system and multi-function steering wheel. It also replicates the iPod display on the audio screen and DIS, including track titles. The interface provides charging function (dependent on device)

Audi sound system

- 6-channel amplifier
- 180-Watt amplifying capacity
- Two 200mm speakers and two tweeters in front doors
- 100mm front centre speaker
- 2-way system with 168mm wide speaker and tweeters in the rear
- 260mm subwoofer located in the parcel shelf



18" x 8J '7-arm' design alloy wheels



MMI controls featuring MMI touch

Satellite Navigation system – HDD-based

- 2x SD card readers
- 3D and topographical mapping display including advanced 3D building display in select cities
- 7-digit postcode recognition
- 60GB hard drive, 20GB of which can be used to store up to 8,000 songs
- Advanced speech recognition
- AM/FM tuner with TP memo function
- High resolution (840x480) 8" colour TFT display
- MP3 compatible front-loading CD/DVD player
- Route planning and guidance using voice, pictogram and 3D mapping

MMI Touch. A touch-sensitive control panel which can be used to enter letters and numbers, scroll lists and easily move around navigation maps

DAB digital radio

Colour Driver's Information System, with 7" high-resolution display, efficiency programme and break recommendations

Mobile telephone preparation – Bluetooth interface

Safety and security

Audi parking system plus. Aids parking by acoustically and visually indicating distances to obstacles in front of and behind the Audi A8

3-point seat belts for all seats, front with electric height adjustment and memory function

Airbags, full size, for driver and front passenger

Audi backguard head restraints

Audi Space Frame (ASF) construction with aluminium chassis

Automatic headlight range adjustment**Cruise control**

Door mirrors – electrically-adjustable, folding, heated and auto-dimming

Double glazing. Improved insulation against outside noise and break-in protection

Electrically-adjustable steering column with memory and adjustment for height and reach with auto easy-entry-and-exit function

Electromechanical parking brake

Electronic Differential Lock (EDL) traction control

Electronic Stability Program (ESP) with two stage deactivation

First aid kit with warning triangle**Front passenger airbag deactivation****Headlight washers**

ISOFIX child-seat mountings for outer-rear seats

LED rear lights

Light and rain sensor package. Includes automatic headlight activation, automatic windscreen wipers, coming home/leaving home function and sun band for windscreen

Pre-sense basic, which provides you with comprehensive preventive protection. This advanced safety system can detect an imminent collision and tighten the seat belts, close the sunroof and windows, and activate the hazard warning lights to alert other drivers

Rear fog lights

Servotronic steering – power steering with speed-dependent control

Sideguard head airbag system

Thatcham category 1 alarm and immobiliser

Tool kit**Tyre pressure loss indicator**

Xenon Plus headlights with LED daytime-running lights



Gear selector lever and MMI controls



Xenon Plus headlights with LED daytime-running lights

SE model equipment continued

Interior equipment

4-spoke multi-function steering wheel with gear-shift paddles

Auto-dimming rear-view mirror

Analogue clock in lower inlay

Comfort front centre armrest.

Split for driver and passenger with fold-up storage compartments; horizontally and vertically adjustable

Cloth headlining (colour dependent on chosen upholstery) – please see page 36

Climate control with sun sensor

- Air quality sensor
- Air humidity sensor (internal and external)
- Automatic defrost function
- Cooled glove compartment
- Choice of three different climates
- Rear ventilation for footwell, centre and B-pillar
- Separate air distribution, temperature controls and display for driver and front passenger
- Sensitive moisture detectors to help avoid misted windows
- Temperature controls for footwell on driver and front passenger side

LED ambient lighting package:*

- Colour choice (Ruby, Ivory or Polar) can be controlled via MMI
- Light strip between grab handles, 2 colours
- LED footwell lights (front and rear), 2 colours
- LED entry lights (x4)
- Illuminated door pockets, 2-colour LED
- Light guide for front and rear doors, 3-colour LED
- Illuminated centre console giving 'floating' effect, 3-colour LED
- LED active door warning lights (x4)
- Roof module, 2-colour light strip/3-colour reflected light

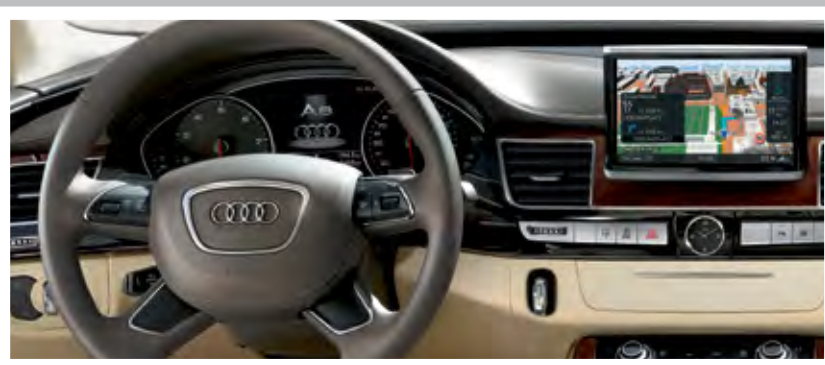

4-spoke multi-function steering wheel and Satellite Navigation system – HDD-based†



LED ambient lighting package

*2-colour: Polar or Ivory. 3-colour: Polar, Ivory or Ruby.

†Actual finish of multi-function steering wheel may differ from image shown.

Extended aluminium look in interior

- Brushed aluminium silver switches in lower inlay, centre console and door
- Air vent slats and thumbwheels in chrome trims
- Aluminium inlay on folding compartment in door armrest
- Stainless steel boot sill protector

Front and rear floor mats**Front passenger storage**

- Cooled glove compartment
- Door storage pockets with space for 1-litre bottle
- Front footwell net
- Glasses holder integrated into roof module
- Parking ticket holder in sun visor
- Storage compartment in door armrest with space for small umbrella
- Two cup-holders in centre console

Front sun visors with illuminated vanity mirrors

Keyless go

Lower inlays in highly-polished black

Upper inlays in Walnut brown

Luggage compartment pack**Rear passenger storage:**

- 12V socket
- Centre armrest with storage compartment and two cup holders
- Door storage pockets
- Luggage net
- Two integrated bag hooks
- Umbrella holder

Exterior equipment

Body coloured door mirrors, handles and bumpers

Aluminium trim strips framing windows

Twin exhaust pipes, one on each side

Metallic or pearl-effect paint

Automatically opening boot lid

Windscreen washer jets, heated



Upper inlays in Walnut brown and lower inlays in highly-polished black



Keyless go

SE Executive model equipment

In addition to SE model equipment

Basic RRP
£2,170.83

Total RRP inc VAT
£2,605.00

Wheels, tyres and suspension

19" x 9J '10-spoke Y' design alloy wheels, with 255/45 R19 Y tyres

quattro with Sports differential.

The electronically regulated Sports differential distributes power individually between the back wheels, giving outstanding handling characteristics (standard on 4.2 TDI only)

Safety and security

Audi parking system advanced with reversing camera. Aids parking by acoustically and visually indicating distances to obstacles with guiding lines. Measured by sensors and reversing camera

Interior equipment

Lower inlays in brushed aluminium

Advanced key – keyless entry and keyless go

Exterior equipment

Power-operated boot lid which opens and closes electrically. Opened via radio-operated remote car key, button in the driver's door or the soft-touch button in the boot-lid recess. Closed by pressing the button on the inside of the boot lid

Audi hands-free boot opening system.

Allows the opening of the boot lid by a simple foot movement underneath the rear bumper to trigger the automatic opening of the tailgate



19" x 9J '10-spoke Y' design alloy wheels

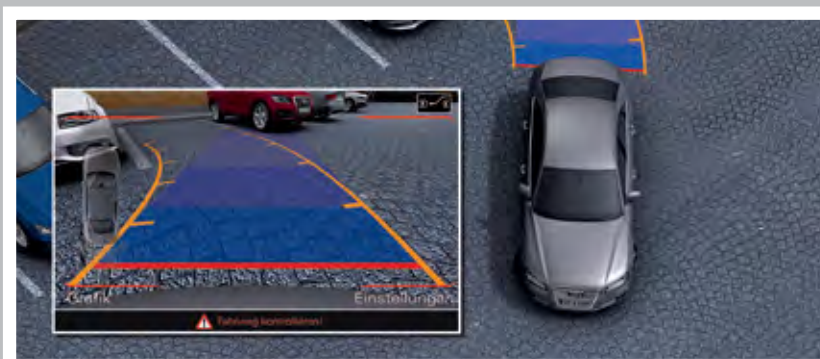

Audi parking system advanced

Long wheelbase model equipment

In addition to SE model equipment

Basic RRP
£3,304.17

Total RRP inc VAT
£3,965.00

Seats

Heated front and rear outer seats

Interior equipment

130mm of additional legroom for rear passengers

Electric blinds for rear window and for rear door windows

LED ambient lighting package, plus:

- Illumination of rear centre console, 3-colour LED

Deluxe 4-zone climate control including rear comfort centre armrest. As standard climate control plus:

- Separate air distribution and temperature controls for driver, front passenger and both sides in the rear

- Additional air conditioning controls and unit in the rear comfort centre armrest

- Residual heat utilisation – the heating system will use the heat generated from the engine to keep the car warm after the ignition has been switched off

- Footwarmer – a higher/lower temperature can be set for the driver and passenger footwells whilst maintaining a different temperature for the main cabin area

- Indirect air regulation – once cabin is up to desired temperature, heated/cooled air is only circulated via the vents at the base of the windscreen and flows around the car meaning air is not directly blown at driver/passengers

Exterior equipment

Electric slide-and-tilt sunroof. Includes position pre-selection, tinted glass insert, variable sunshield and convenience closing

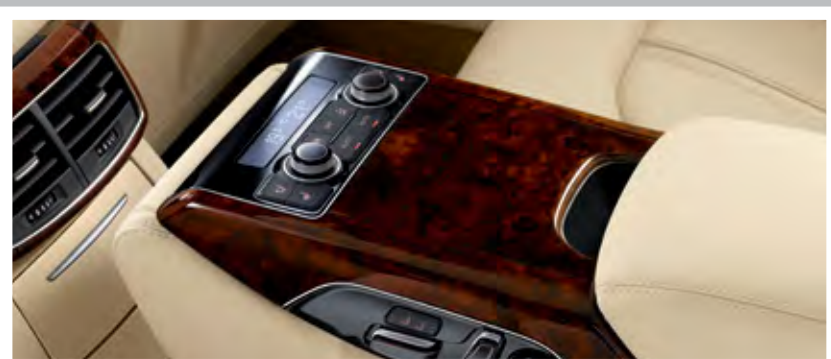

Deluxe 4-zone climate control



Electric slide-and-tilt sunroof

RRP – Recommended Retail Price. VAT is calculated at 20% but this may alter to reflect any change in the applicable VAT rate.

S8 model equipment

In addition to SE Executive model equipment

Wheels, tyres and suspension

20" x 9J '5-parallel spoke S' design alloy wheels, with 265/40 R20 Y tyres

'S' Sports adaptive air suspension with electronic shock-absorption control – additional stiffer damping. Vehicle height can be decreased by up to 5mm. Increased functionality through Audi drive select

Dynamic steering. Steering angle and steering torque requirement adjusted dependent on road speed. Can also be adjusted through Audi drive select. ESP uses the dynamic steering function along with the brakes to apply active steering interventions when the vehicle is over or under-steering

Seats

Valcona leather

'S' Comfort front Sports seats with memory function (22-way adjustable). As standard seat plus:

- Stitched diamond design with perforated leather seat front
- Electrically adjustable upper backrest
- Electrically adjustable seat cushion depth
- Electrically adjustable comfort headrests
- Pneumatic lumbar support
- Pneumatic side bolster adjustment

Audio and communication

Mobile telephone preparation – High with Audi connect.* A mobile phone can be connected to the internal UMTS (3G) module via Bluetooth (provided the mobile telephone has SIM Access Profile), or alternatively through the additional SIM card reader. It is possible to transfer phone book entries to the car and manage call lists.

Audi connect features include:

- Navigation using Google Earth images and Google Street View
- Destination entry via Google Maps or myAudi
- Online point of interest search and information services such as weather forecasts and the latest world news
- Audi traffic information online, which gives exact and accurate real-time forecasts of the traffic situation along the chosen route
- Wi-Fi hotspot in the car for convenient internet access using a mobile device (e.g. laptop or tablet)

BOSE® surround sound system. Includes:

- 14 high-performance speakers including subwoofer
- Two tweeters and a centre speaker in dashboard
- Two bass modules with BOSE® Acoustic Wave speaker technology and two mid-range driver speakers in front doors
- Two mid-range drivers in doors and two tweeters in the B pillars in rear doors



20" x 9J '5-parallel spoke S' design alloy wheels

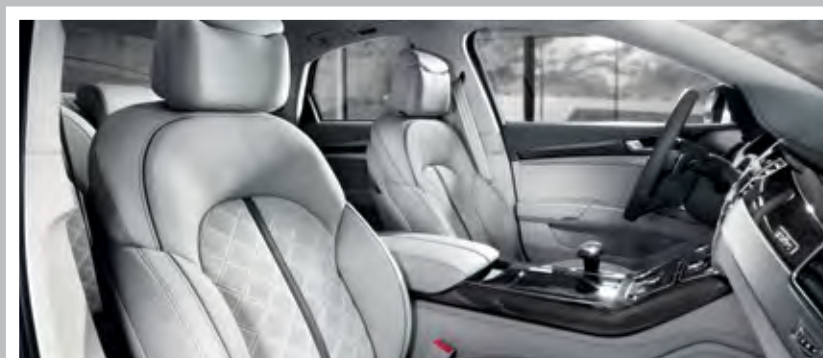

'S' Comfort front Sports seats in Lunar silver Valcona leather

*Please see page 54 for important information and restrictions regarding Audi connect.

- A subwoofer and two surround sound speakers in parcel shelf
- 12 channel DSP amplifier with over 600 Watt output located in boot
- Surround sound reproduction from digital 5.1 recordings (DVD) and from stereo sources (CD, Radio, MP3) via the patented BOSE® Centerpoint 2 technology
- Speaker trim design with chromed plastic frames, protector and BOSE® logo

CD/DVD changer for 6 DVDs and/or CDs (MP3, WMA, AAC and WMV formats) located in the glovebox

Safety and security

'S' model enhanced braking system

All-LED headlights including high-beam assist. LEDs for all front lighting functions. LED technology provides lower energy consumption and enhanced contrast with a colour similar to daylight, for increased safety and good recognition by other road users. Includes all-weather light function

to reduce the risk of the driver being dazzled when visibility is poor (in fog, rain or snow), turning light function which is activated when indicator is switched on (up to speeds of 45mph), and an additional motorway light which automatically increases headlight range at speeds above approximately 68mph. Also includes high-beam assist which automatically adjusts headlights from high-beam to dipped-beam when another vehicle is approaching or when other ambient lighting is detected (i.e. street lights) by a camera on the interior mirror

Interior equipment

3-spoke 'S' multi-function steering wheel with gear-shift paddles and contrast stitching

Illuminated door sill trims with S8 logo

Extended leather package plus. Fine Nappa leather with decorative stitching on:

- Door armrest
- Centre console

- Knee pads
 - Airbag cover on steering wheel
 - Bottom of door panels
 - Door pockets
 - Bottom of instrument panel including exterior of glove compartment
 - Area surrounding the MMI
- Alcantara package.** With headlining, A, B, C, D pillars and parcel shelf in Alcantara

Gear selector lever in Carbon Atlas

Upper inlays in Carbon Atlas

Lower inlays in brushed aluminium

'S' instrument dials, in grey with white needles and S8 badge

Active noise cancellation. Effectively compensates for interference noise inside the car, depending on the interior noise level and engine speed. Four microphones installed in the roof lining register background engine noise and, if necessary, a precisely calculated antiphase sound is emitted through the car's internal sound system

Exterior equipment

Aluminium-effect door mirror housings

Dual-branch oval twin tailpipes in chrome finish

'S' platinum grey single frame grille with dual struts in chrome and S8 logo

Painted black brake callipers with S8 logo

'S' body styling

V8T badge on wheel arch above indicator



Inlays and gear selector lever in Carbon Atlas

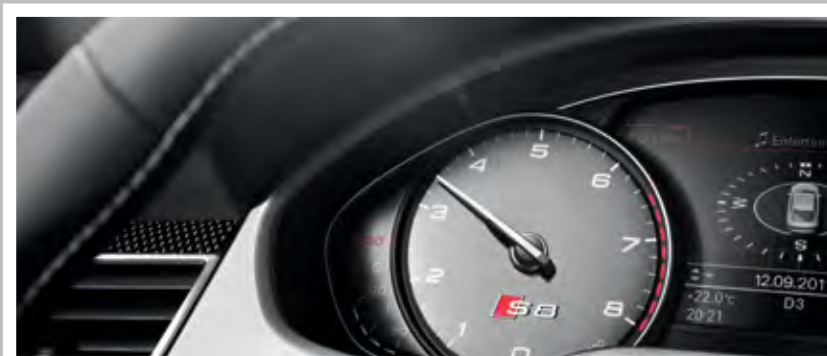

'S' instrument dials

W12 long wheelbase model equipment

In addition to long wheelbase SE Executive model equipment

Wheels, tyres and suspension

19" x 9J '15-spoke' design partly polished alloy wheels with 255/45 R19 Y tyres

Audio and communication

Mobile telephone preparation – High with Audi connect.* A mobile phone can be connected to the internal UMTS (3G) module via Bluetooth (provided the mobile telephone has SIM Access Profile), or alternatively through the additional SIM card reader. It is possible to transfer phone book entries to the car and manage call lists. Audi connect features include:

- Navigation using Google Earth images and Google Street View
- Destination entry via Google Maps or myAudi
- Online point of interest search and information services such as weather forecasts and the latest world news
- Audi traffic information online, which gives exact and accurate real-time forecasts of the traffic situation along the chosen route

- Wi-Fi hotspot in the car for convenient internet access using a mobile device (e.g. laptop or tablet)

BOSE® surround sound system. Includes:

- 14 high-performance speakers including subwoofer
- Two tweeters and a centre speaker in dashboard
- Two bass modules with BOSE® Acoustic Wave speaker technology and two mid-range driver speakers in front doors
- Two mid-range drivers in doors and two tweeters in the B pillars in rear doors
- A subwoofer and two surround sound speakers in parcel shelf
- 12 channel DSP amplifier with over 600 Watt output, located in boot
- Surround sound reproduction from digital 5.1 recordings (DVD) and from stereo sources (CD, Radio, MP3) via the patented BOSE® Centerpoint 2 technology
- Speaker trim design with chromed plastic frames, protector and BOSE® logo

CD/DVD changer for 6 DVDs and/or CD's (MP3, WMA, AAC and WMV formats) located in the glovebox

Car phone in centre armrest

Safety and security

All-LED headlights including high-beam assist. LEDs for all front lighting functions. LED technology provides lower energy consumption and enhanced contrast with a colour similar to daylight, for increased safety and good recognition by other road users. Includes all-weather light function to reduce the risk of the driver being dazzled when visibility is poor (in fog, rain or snow), turning-light function which is activated when indicator is switched on (up to speeds of 45mph), and an additional motorway light which automatically increases headlight range at speeds above approximately 68mph. Also includes high-beam assist which automatically adjusts headlights from high-beam to dipped-beam when another vehicle is approaching or when other ambient lighting is detected (i.e. street lights) by a camera on the interior mirror



19" x 9J '15-spoke' design partly polished alloy wheels



All-LED headlights including high-beam assist

*Please see page 54 for important information and restrictions regarding Audi connect.

Seats

Valcona Leather

Comfort front seats with memory function (22-way adjustable). As standard seat plus:

- Comfort look design
- Electrically adjustable upper backrest
- Electrically adjustable seat cushion depth
- Electrically adjustable comfort headrests
- Pneumatic lumbar support
- Pneumatic side bolster adjustment

Individual electrically adjustable rear seats with memory function (12-way adjustable) including:

- Electrically adjustable forwards and backwards including backrest angle
- Electrically adjustable upper backrest
- Pneumatic lumbar support with electric adjustment
- Comfort rear headrests with manually adjustable sides
- Front passenger seat adjustment from the rear

Interior comfort

Extended leather package plus. Fine Nappa leather with decorative stitching on:

- Door armrest
- Centre console
- Knee pads
- Airbag cover on steering wheel
- Bottom of door panels
- Door pockets
- Bottom of instrument panel including exterior of glove compartment
- Area surrounding the MMI

Piano black inlays in unique W12 design

Alcantara package. With headlining, A, B, C, D pillars and parcel shelf in Alcantara

Rear vanity mirror

Two additional rear reading lights

Exterior comfort

Power door closure

Laminated windshield with metal layer and viewing window for Vehicle Identification Number

Side and rear window in laminated glass



Car phone in centre armrest



Unique W12 design

A8 SE

Engines	Power	Transmissions	CO ₂ g/km	Basic RRP	Total RRP inc VAT	Recommended OTR
3.0 TDI	204PS	8-speed tiptronic	158	£43,808.33	£52,570.00	£53,385.00
3.0 TDI quattro	250PS	8-speed tiptronic	169	£46,416.67	£55,700.00	£56,620.00

A8 SE Executive

Engines	Power	Transmissions	CO ₂ g/km	Basic RRP	Total RRP inc VAT	Recommended OTR
3.0 TFSI quattro	290PS	8-speed tiptronic	204	£48,587.50	£58,305.00	£59,550.00
3.0 TDI	204PS	8-speed tiptronic	158	£45,979.17	£55,175.00	£55,990.00
3.0 TDI quattro	250PS	8-speed tiptronic	169	£48,587.50	£58,305.00	£59,225.00
4.2 TDI quattro	350PS	8-speed tiptronic	195	£56,150.00	£67,380.00	£68,485.00

S8

Engine	Power	Transmission	CO ₂ g/km	Basic RRP	Total RRP inc VAT	Recommended OTR
4.0 TFSI quattro	520PS	8-speed tiptronic	235	£63,700.00	£76,440.00	£77,900.00

Please note: The maximum power output figures are quoted in PS (or Pferdestärke, which is the metric equivalent of brake horsepower). To convert to brake horsepower, divide the PS figure by 1.0139.

Recommended On-The-Road (OTR) retail prices include: delivery charge, half a tank of fuel, number plates at £590.00 (inc. VAT), Road Fund Licence (which may vary depending on model/transmission – see page 74 for details) and first registration fee at £55.00.

RRP – Recommended Retail Price. VAT is calculated at 20% but this may alter to reflect any change in the applicable VAT rate.

A8L SE

Engines	Power	Transmissions	CO ₂ g/km	Basic RRP	Total RRP inc VAT	Recommended OTR
3.0 TDI	204PS	8-speed tiptronic	161	£47,112.50	£56,535.00	£57,350.00
3.0 TDI quattro	250PS	8-speed tiptronic	171	£49,720.83	£59,665.00	£60,585.00

A8L SE Executive models

Engines	Power	Transmissions	CO ₂ g/km	Basic RRP	Total RRP inc VAT	Recommended OTR
4.0 TFSI quattro	420PS	8-speed tiptronic	211	£59,891.67	£71,870.00	£73,115.00
3.0 TDI	204PS	8-speed tiptronic	161	£49,283.33	£59,140.00	£59,955.00
3.0 TDI quattro	250PS	8-speed tiptronic	171	£51,891.67	£62,270.00	£63,190.00
4.2 TDI quattro	350PS	8-speed tiptronic	198	£59,454.17	£71,345.00	£72,450.00

A8L W12

Engine	Power	Transmission	CO ₂ g/km	Basic RRP	Total RRP inc VAT	Recommended OTR
6.3 W12 quattro	500PS	8-speed tiptronic	277	£77,887.50	£93,465.00	£95,140.00



Audi exclusive

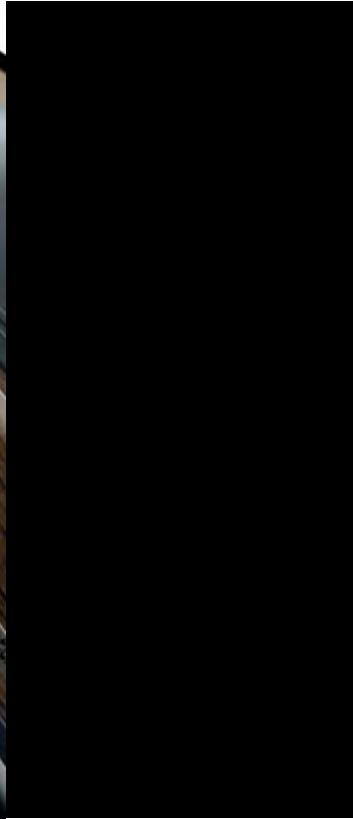

Every Audi is intrinsically exclusive. It's the breathtaking design, the exceptional engineering, the Vorsprung durch Technik. But for that special touch you can specify your A8 with options from Audi exclusive. Whether you want a unique, custom-mixed paint colour or seats in a combination of complementary shades, Audi exclusive will enable you to drive the car you've always imagined.

Both the exclusive and standard options can be found on the following pages.

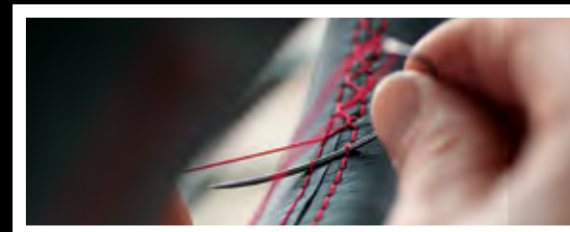
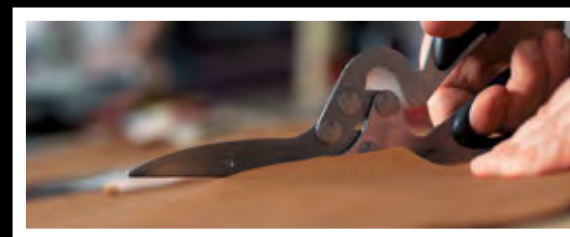
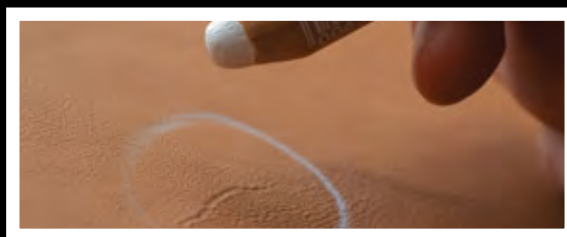

Paint

You can either select one of the colours shown opposite or an Audi exclusive range colour

Standard colours

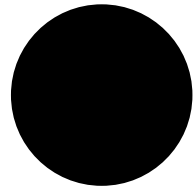

Brilliant black – A2



Ibis white – T9



Glacier white, metallic – 2Y

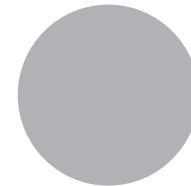

Ice silver, metallic – P5

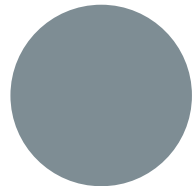

Quartz grey, metallic – Q4

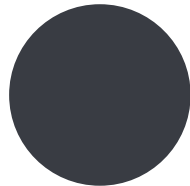

Oolong grey, metallic – 4N

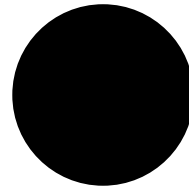

Havana black, metallic – 4J

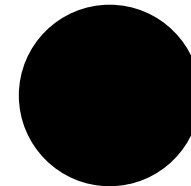

Emerald black, metallic – 3G

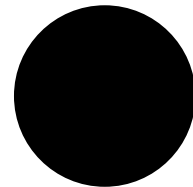

Phantom black, pearl effect – L8

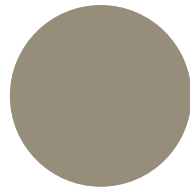

Impala beige, pearl effect – T2

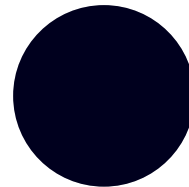

Night blue, pearl effect – 7X

S8 colours

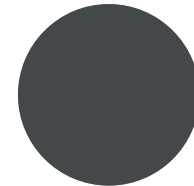

Daytona grey, pearl effect – 6Y



Prism silver, crystal effect – T0

Options are subject to availability and may extend delivery.

All the colour swatches on this page are matched as accurately as possible to the actual paint colours used. However, due to print processes, Audi UK cannot guarantee that colours shown are 100% accurate.

Visit your local Audi Centre for a more accurate colour swatch.

RRP – Recommended Retail Price.

Standard colours

Basic RRP
No charge

Total RRP inc VAT
No charge

S8 colour Prism silver, crystal effect

Basic RRP
£541.67

Total RRP inc VAT
£650.00

Paint

Audi exclusive

Everyone has a favourite colour. No matter what yours is, Audi exclusive provides a range of unique colours that have been designed to set your car apart. Choose from the swatches here, or specify any other paint colour in the Audi range – whether it's Jet blue from the Audi R8 or Alpine white from the original Audi quattro. The choice is yours.

Customised

If you have a particular colour in mind, we'll mix the exact metallic or pearl-effect shade you want*.

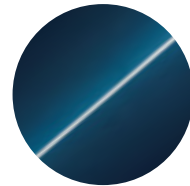

Palace blue, pearl effect

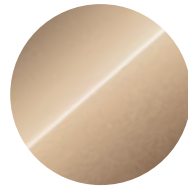

Sand beige, pearl effect

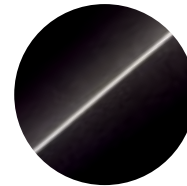

Saddle brown, pearl effect

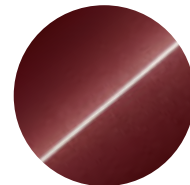

Classic red, pearl effect

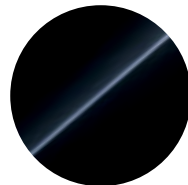

Mamba black, metallic

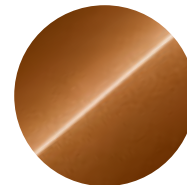

Ipanema brown, metallic



Any colour in the Audi range



100 Audi exclusive colours to choose from**

Audi exclusive
Basic RRP £1,787.50
Total RRP inc VAT £2,145.00



Customised paint

Customised
Basic RRP £2,725.00
Total RRP inc VAT £3,270.00

*Custom paint is subject to factory approval, and is available for metallic and pearl-effect water-based paints only. Three-colour process colours and two-tone schemes are not available.

**Visit your local Audi Centre for colour samples.

All the colour swatches on this page are matched as accurately as possible to the actual paint colours used. However, due to print processes, Audi UK cannot guarantee that colours shown are 100% accurate.

Visit your local Audi Centre for a more accurate colour swatch.

RRP – Recommended Retail Price.

VAT is calculated at 20% but this may alter to reflect any change in the applicable VAT rate.

Upholstery and seats

Standard seats and upholstery

12-way electrically-adjustable seats with electric lumbar support and memory function. You can also choose your favourite upholstery from the swatches shown opposite to give your car's interior the look and feel you want.

Valcona leather



Black - FZ

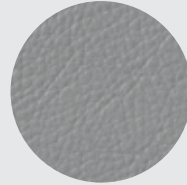

Titanium grey - KN

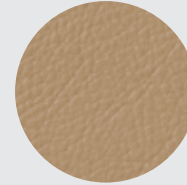

Velvet beige - KP

	SE	SE Executive	SE long wheelbase	SE Executive long wheelbase	S8	W12 long wheelbase	Basic RRP	Total RRP inc VAT
	S	S	S	S	-	-	No charge	No charge

Seating options

If you choose Standard seats you can also take advantage of heated front and outer rear seats. For more luxurious options, select either Comfort seats or Comfort Sports seats.

Order Code

	SE	SE Executive	SE long wheelbase	SE Executive long wheelbase	S8	W12 long wheelbase	Basic RRP	Total RRP inc VAT
4A4 Heated outer rear seats	●	●	S	S	-	-	£375.00	£450.00

Options are subject to availability and may extend delivery.

- = Not available
- = Available
- S = Standard

RRP - Recommended Retail Price.

VAT is calculated at 20% but this may alter to reflect any change in the applicable VAT rate.



Standard seats



Comfort seats (PS8)



Comfort Sports seats (PS1)

Upholstery and seats

Comfort seats and upholstery

Comfort front seats come with memory function and can be adjusted 22 ways. They come with electrically adjustable upper backrest, seat cushion depth and comfort headrests. You'll also be able to choose from pneumatic lumbar support and pneumatic side bolster adjustment.

Comfort seats also benefit from an additional storage compartment to their rear.









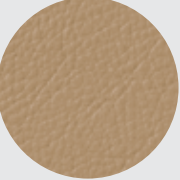

Options are subject to availability and may extend delivery.

- = Not available
● = Available
S = Standard

*Only in combination with front (4D5) or front and rear (4D2) seat ventilation and massage function, and comfort headrests for rear seats (VA2) or individual electrically adjustable outer rear seats (PE6).

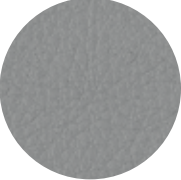
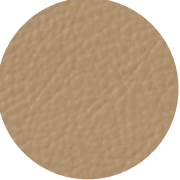
RRP - Recommended Retail Price.

VAT is calculated at 20% but this may alter to reflect any change in the applicable VAT rate.

			SE	SE Executive	SE long wheelbase	SE Executive long wheelbase	S8	W12 long wheelbase	Basic RRP	Total RRP inc VAT
Valcona leather	 Black - FZ	 Titanium grey - KN	●	●	●	●	-	S	£979.17	£1,175.00
	 Velvet beige - KL/KP									
	 Nougat brown - RZ	 Silk beige - KQ	-	-	-	-	●	-	No charge	No charge
Natural leather	 Black - FZ	 Titanium grey - KN	●	●	●	●	-	-	£1,320.83	£1,585.00
	 Velvet beige - KP									
	 Nougat brown - RZ		-	-	-	-	●	●	£341.67	£410.00
Perforated Valonea leather*	 Black - FZ	 Nougat brown - RZ	●	●	●	●	-	-	£2,766.67	£3,320.00
			-	-	-	-	●	●	£1,787.50	£2,145.00



Comfort seats (PS8) with individual electrically adjustable outer rear seats (PE6) and seat ventilation, front and outer rear (4D1) in Silk beige Valcona leather

Upholstery and seats

Comfort Sports seats and upholstery

Comfort front Sports seats come with memory function and can be adjusted 22 ways. They come in stitched diamond design, along with electrically adjustable upper backrest, seat cushion depth and comfort headrests. You'll also be able to choose from pneumatic lumbar support and pneumatic side bolster adjustment.

Comfort Sports seats also benefit from an additional storage compartment on the rear of the seat.

Valcona leather



Black - FZ

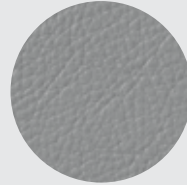

Titanium grey - KN

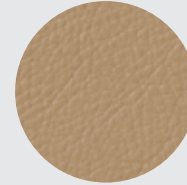

Velvet beige - KL/KP



Nougat brown - RZ

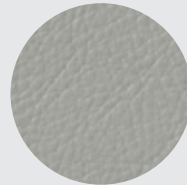

Lunar silver - KX*

Valcona leather/
Alcantara



Black - FZ

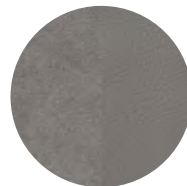

Titanium grey - KN

SE	SE Executive	SE long wheelbase	SE Executive long wheelbase	S8	W12 long wheelbase	Basic RRP	Total RRP inc VAT
●	●	●	●	S	-	£1,150.00	£1,380.00
-	-	-	-	-	●	No charge	No charge
●	●	●	●	-	-	£1,150.00	£1,380.00
-	-	-	-	●	●	No charge	No charge

Options are subject to availability and may extend delivery.

- = Not available
- = Available
- S = Standard

*Only available on S8.

RRP - Recommended Retail Price.

VAT is calculated at 20% but this may alter to reflect any change in the applicable VAT rate.



Comfort Sports seats (PS1) and rear seat package (PE2) with Audi exclusive leather package 4 (PYK) in Magnolia white and Chestnut brown

Upholstery and seats

Seating options

If you choose Comfort seats or Comfort Sports seats, you can take advantage of the luxurious options opposite.

Options are subject to availability and may extend delivery.

– = Not available
● = Available
S = Standard

*YSB must be added with Comfort front Sports seats (PS1) when ordering a rear seat package (PE6, PE1 or PE2).

RRP – Recommended Retail Price.

VAT is calculated at 20% but this may alter to reflect any change in the applicable VAT rate.

Order Code		SE	SE Executive	SE long wheelbase	SE Executive long wheelbase	S8	W12 long wheelbase	Basic RRP	Total RRP inc VAT
4A4	Heated outer rear seats	●	●	S	S	●	S	£375.00	£450.00
4D3	Seat ventilation, front. Ventilation of the centre section of front seats, adjustable to three levels. Not available in combination with Valcona leather (N2B). Please note: to allow for seat ventilation, leather of the seat front is perforated	●	●	●	●	●	●	£637.50	£765.00
4D1	Seat ventilation, front and outer rear. Ventilation of the centre section of front seats and outer rear seats, adjustable to three levels. Only in combination with individual electrically adjustable rear seats (PE6 or PE6/YSB*). Not in combination with Valcona leather (N2B). Please note: to allow for seat ventilation, the leather of the seat front is perforated. Not available on 3.0 TDI (204PS)	●	●	●	●	●	●	£1,275.00	£1,530.00
4D7	Massage seats, front. Massage function for front passengers, with five massage programs adjustable to three different intensities	●	●	●	●	●	●	£725.00	£870.00
4D4	Massage seats, front and outer rear. Massage function for front passengers, with five massage programs adjustable to three different intensities. Massage function for outer rear passengers, with two massage programs adjustable to three different intensities. Only in combination with Comfort seats (PS8) and individual electrically adjustable rear seats (PE6). Not available in combination with Comfort Sports seats (PS1) or on 3.0 TDI (204PS)	●	●	●	●	●	●	£1,275.00	£1,530.00
4D5	Seat ventilation and massage function for front seats. Ventilation of the centre section of front seats, adjustable to three levels. Massage function for front passengers, with five massage programs adjustable to three different intensities	●	●	●	●	●	●	£1,362.50	£1,635.00
4D2	Seat ventilation and massage function for front and outer rear seats. Ventilation of the centre section of front seats and outer rear seats, adjustable to three levels. Massage function for front passengers, with five massage programs adjustable to three different intensities. Massage function for outer rear passengers, with two massage programs adjustable to three different intensities. Operated by the control panel in the rear centre armrest. Only in combination with individual electrically adjustable rear seats (PE6 or PE6/YSB*). Please note: to allow for seat ventilation, the leather of the rear seats is perforated. Not available on 3.0 TDI (204PS)	●	●	●	●	●	●	£2,550.00	£3,060.00
		●	●	●	●	●	●	●	£1,187.50
	Individual electrically adjustable outer rear seats. Including: - Separate electrically adjustable outer rear seats (5Z1) - Electrically adjustable forward/backwards positioning, including backrest angle - Electrically adjustable upper backrest - Comfort rear headrests (VA2) - Memory function for each outer seat - Front passenger seat adjustment from the rear (4V1)	●	●	–	–	●	–	£3,916.67	£4,700.00
PE6	- Power adjustable lumbar support in front seats and outer rear seats (7P3) - Seat heating for front seats and outer rear seats (4A4) - 4-zone automatic air conditioning (9AH) - Electrically operated roll-up sunblinds for rear window and for rear door windows (3Y8) Only in combination with Comfort front seats (PS8), Comfort front Sports seats (PS1/YSB*) and seat ventilation, front and outer rear (4D1) or seat ventilation and massage function for front and outer rear seats (4D2), or Audi design selection (PEX/PEZ) Not available on 3.0 TDI (204PS)	–	–	●	●	–	S	£1,670.83	£2,005.00
VA2	Comfort headrests for rear seats with manually adjustable sides to provide more support and increased comfort	●	●	●	●	●	S	£212.50	£255.00

Upholstery and seats

Seating options

If you choose Comfort seats or Comfort Sports seats, you can take advantage of the luxurious options opposite.

Order Code	SE	SE Executive	SE long wheelbase	SE Executive long wheelbase	S8	W12 long wheelbase	Basic RRP	Total RRP inc VAT
PE1	Rear seat package – two individual rear seats - Comfort rear headrests (VA2) - Front passenger seat adjustment from rear (4V1) - Electrically adjustable lumbar support for outer rear seats (7P3) - Two individual rear seats 12-way electrically adjustable (5Z3) - Continuous centre console Must be combined with Comfort seats (PS8) or Comfort Sports seats (PS1/YSB*), Extended leather package (7HB), seat ventilation front and rear (4D1) and 230V socket (9Z3)						£4,475.00	£5,370.00
	-	-	-	-	-	●	£2,225.00	£2,670.00
PE2	Rear seat package – two individual rear seats with reclining seat and foot rest - Comfort rear headrests (VA2) - Front passenger seat adjustment from rear (4V1) - Electrically adjustable lumbar support for outer rear seats (7P3) - Two individual rear seats 12-way electrically adjustable with reclining seat and foot rest (5Z2) Please note the reclining seat with foot rest is the rear seat behind the front passenger. The foot rest will replace the storage compartment on the rear of the front seat - Rear Seat Entertainment (9WP) - Continuous centre console Must be combined with Comfort seats (PS8) or Comfort Sports seats (PS1/YSB*), Extended leather package (7HB), seat ventilation and massage function for front and rear seats (4D2), 230V socket (9Z3) and BOSE® surround-sound system (8RY) or Bang & Olufsen Advanced Sound System (8RF)						£8,383.33	£10,060.00
	-	-	-	-	-	●	£6,133.33	£7,360.00

Options are subject to availability and may extend delivery.

- = Not available
- = Available
- S = Standard

*YSB must be added with Comfort front Sports seats (PS1) when ordering a rear seat package (PE6, PE1 or PE2).

RRP – Recommended Retail Price.

VAT is calculated at 20% but this may alter to reflect any change in the applicable VAT rate.

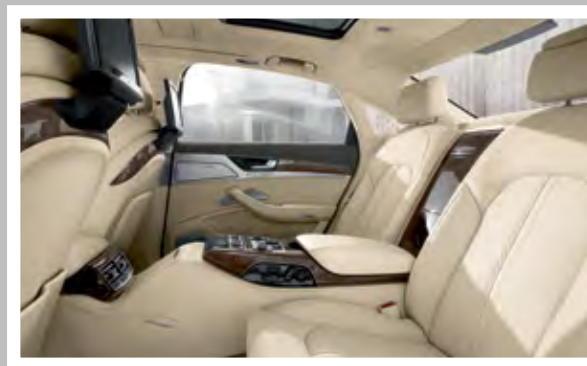

Rear seat package – two individual rear seats with reclining seat and foot rest (PE2)



Colour and trim guide

Interior trim colours

To help you choose the right interior for your new Audi A8, please use this guide, showing the carpet, dashboard and headlining colours that have been matched to your chosen upholstery.

	FZ	KL	KN	KP	KQ	RZ	KX ⁺	KS*	KT**
Seat upholstery	Black	Velvet beige	Titanium grey	Velvet beige	Silk beige	Nougat brown	Lunar silver	Balao brown	Brass beige
Steering wheel, gear lever	Black	Black	Steel grey	Moor brown	Moor brown	Black	Steel grey, Carbon atlas	Mocca brown	Granite grey
Top of dashboard	Black	Black	Steel grey	Moor brown	Moor brown	Black	Steel grey	Mocca brown	Granite grey
Bottom of dashboard	Black	Black	Titanium grey	Velvet beige	Silk beige	Black	Lunar silver	Balao brown	Brass beige
Centre console	Black	Black	Titanium grey	Velvet beige	Silk beige	Black	Lunar silver	Balao brown	Brass beige
Centre armrest (front and rear)	Black	Velvet beige	Titanium grey	Velvet beige	Silk beige	Nougat brown	Lunar silver	Balao brown	Brass beige
Door armrests	Black	Black	Titanium grey	Velvet beige	Silk beige	Black	Lunar silver	Balao brown	Brass beige
Top of door	Black	Black	Steel grey	Moor brown	Moor brown	Black	Steel grey	Mocca brown	Granite grey
Door card	Black	Velvet beige	Titanium grey	Velvet beige	Silk beige	Nougat brown	Lunar silver	Balao brown	Brass beige
Carpet	Black	Black	Titanium grey	Velvet beige	Velvet beige	Black	Titanium grey	Balao brown	Brass beige
Headlining	Lunar silver	Silk beige	Lunar silver	Silk beige	Silk beige	Lunar silver	Lunar silver	Snow white	Snow white
Parcel shelf	Black	Velvet beige	Titanium grey	Velvet beige	Silk beige	Black	Lunar silver	Balao brown	Brass beige
Seat belts	Black	Black	Titanium grey	Velvet beige	Silk beige	Black	Lunar silver	Black	Black

Standard seats

Valcona leather (N5D)	●	–	●	●	–	–	–	–	–
-----------------------	---	---	---	---	---	---	---	---	---

Comfort seats

Valcona leather (N5D)	●	●	●	●	●	●	–	●	–
Natural leather (N4K)	●	–	●	●	–	●	–	–	–
Valonea leather (N2B)	●	–	–	–	–	●	–	–	–
Design package Balao brown (PEZ)	–	–	–	–	–	–	–	●	–
Design package Brass beige (PEX)	–	–	–	–	–	–	–	–	●

Comfort Sports seats

Valcona leather/Alcantara (N7R)	●	–	●	–	–	–	–	–	–
Valcona leather (N5D)	●	●	●	●	–	●	●	–	–

Options are subject to availability and may extend delivery.

– = Not available
● = Available
S = Standar

*Only available on S8.

*See page 48 for more information.

**See page 49 for more information.



Comfort seats (P58) with seat ventilation, front and outer rear (4D1) in Silk beige Valcona leather

Upholstery

Audi exclusive

With Audi exclusive, you can specify your seats in an array of different colours shown to the right.

Select just one all-over shade for each seat, or customise each panel in two or more complementary colours from the distinctive Audi exclusive palette. You can even choose the colour of the decorative stitching – to match or contrast with your chosen upholstery.* Whatever combination you decide upon, we think you'll be extremely comfortable with the result.



Chestnut brown

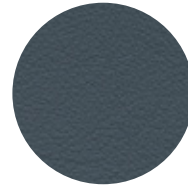

Jet grey



Alabaster white

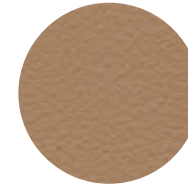

Sand beige

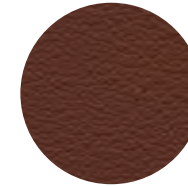

Saddle brown

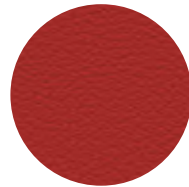

Crimson red



Magnolia white



Havanna brown

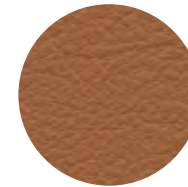

Cognac brown

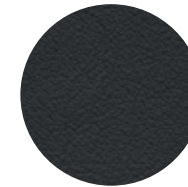

Night blue

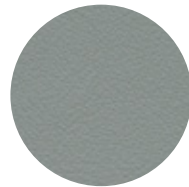

Cloudy grey

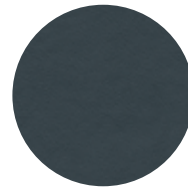

Smoky blue

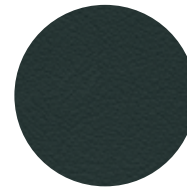

Iceland green

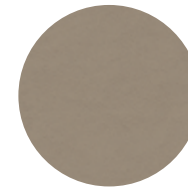

Powder beige

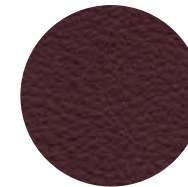

Classic red

*Due to safety considerations contrast stitching is not available on the dashboard/windscreen side.

Also available:

Alcantara: available in all the Audi exclusive colours shown, except for Crimson red, Jet grey and Sand beige. Alcantara equivalents are Chilli red, Amethyst grey, and Sesame beige respectively.

Carpet: available in all the Audi exclusive colours shown.

Dashboard: available in Havanna brown, Saddle brown, Chestnut brown, Cognac brown, Classic red, Crimson red, Jet grey, Night blue, Smoky blue and Iceland green.

Please consult your Audi Centre for examples of Alcantara and carpet colours.

Upholstery

Audi exclusive

Options are subject to availability and may extend delivery.

- = Not available
• = Available
S = Standard

*Can only be ordered in combination with Comfort seats or Comfort Sports seats.

**Can only be ordered in combination with Comfort seats or Comfort Sports seats and one of the leather packages (7HB/C/D).

***Can only be ordered in combination with Comfort Sports seats and one of the leather packages (7HB/C/D).

*Can only be ordered in combination with Comfort seats or Comfort Sports seats and one of the leather packages (7HC/D).

**Can only be ordered in combination with Comfort Sports seats, leather package (7HD), Alcantara headlining (PL4/7), and electric sunblinds for rear window and rear door windows (3Y8).

***Can only be ordered in combination with Comfort seats or Comfort Sports seats, leather package (7HD), Alcantara headlining (PL7), and electric sunblinds for rear window and rear door windows (3Y8).

RRP - Recommended Retail Price.

VAT is calculated at 20% but this may alter to reflect any change in the applicable VAT rate.

Order Code		SE	SE Executive	SE long wheelbase	SE Executive long wheelbase	S8	W12 long wheelbase	Basic RRP	Total RRP inc VAT
PYB S3G	Audi exclusive leather trim package 1 in Valcona leather. Includes leather-covered seat upholstery, backrest covers, centre armrests and door trim inserts. Piping is included, but only if ordered in conjunction with Comfort seats. Seat side trims and add-on parts are colour-coordinated*	•	•	•	•	-	-	£7,062.50	£8,475.00
		-	-	-	-	•	•	£4,829.17	£5,795.00
PYE S3G	Audi exclusive leather package 2 in Valcona leather. Includes all the contents of leather package 1 (PYB) plus: leather-covered centre console, knee pad and door armrests**	•	•	•	•	-	-	£8,937.50	£10,725.00
		-	-	-	-	•	•	£6,704.17	£8,045.00
PYF S3G	Audi exclusive leather package 2 in Valcona leather/Alcantara. Includes leather-covered seat upholstery, backrest covers, centre armrests, door trim inserts, door armrests, centre console, knee pad and Alcantara seat centre sections***	•	•	•	•	-	-	£8,937.50	£10,725.00
		-	-	-	-	•	-	£6,704.17	£8,045.00
PYH S3G	Audi exclusive leather package 3 in Valcona leather. Includes all the contents of leather packages 1 (PYB) and 2 (PYE) plus: leather-covered lower door trim and pockets, dashboard underside, glovebox and MMI trim panel†	•	•	•	•	-	-	£12,254.17	£14,705.00
		-	-	-	-	•	•	£10,020.83	£12,025.00
PYK S3G	Audi exclusive leather package 4 in Valcona leather. Includes all the contents of leather packages 1 (PYB), 2 (PYE) and 3 (PYH) plus: leather-covered steering wheel and column††	•	•	•	•	-	-	£14,129.17	£16,955.00
		-	-	-	-	•	•	£11,895.83	£14,275.00
PYL S3G	Audi exclusive leather package 4 in Valcona leather/Alcantara. Includes all the contents of leather package 2 (PYF) plus: leather-covered steering wheel and column††	•	•	•	•	-	-	£14,129.17	£16,955.00
		-	-	-	-	•	-	£11,895.83	£14,275.00

Packages and special parts

	Item	Package 1	Package 2	Package 3	Package 4	Special parts
Seat side sections in leather/seat centre section in leather or Alcantara	1	●	●	●	●	
Backrest cover in leather	2	●	●	●	●	
Head restraints in leather	3	●	●	●	●	
Lid of front centre armrest in leather	4	●	●	●	●	
Lid of rear centre armrest in leather	5	●	●	●	●	
Door trim insert in leather	6	●	●	●	●	
Colour-matched seat side trims	7	●	●	●	●	
Front centre console including knee bolster in leather. Rear centre console including armrest in leather (not illustrated)	8		●	●	●	
Armrest including door pull handle in leather	9		●	●	●	
Lower section of dashboard including glove compartment in leather	10			●	●	
Lower door trim including door pockets in leather	11			●	●	
MMI trim panel (not illustrated)				●	●	
Colour-matched speaker grilles*	12			●	●	
Colour-matched A-, B- and C-posts	13			●	●	
Steering wheel including airbag cover in leather	14				●	
Colour-matched corpus and steering column	15				●	
Upper section of dashboard in leather	16				●	
Top shoulder in leather	17				●	
Colour-matched cover cap, left and right	18				●	
Rear shelf in Alcantara (not illustrated) – YSG	19					●
Headlining including sun visors and upper posts in Alcantara – YSK	20					●
Roof module including mirror base, colour-matched – YSK	21					●
Colour-matched roof grab handles – YSK	22					●
Colour-matched B-post belt feeder – YSK	23					●
Steering wheel including airbag cover in leather – YRH	24					●
Gear knob in wood – YTD	25					●
Carpeting including floor mats – YSQ	26					●
Inlays – YTA	27					●
Seat belts in special colours – YTO	28					●

Function elements such as backrest adjusters or seat adjusting levers come in the colour of the interior equipment code ordered.

*Bang & Olufsen sound system includes speaker grille in stainless steel.

Packages and special parts

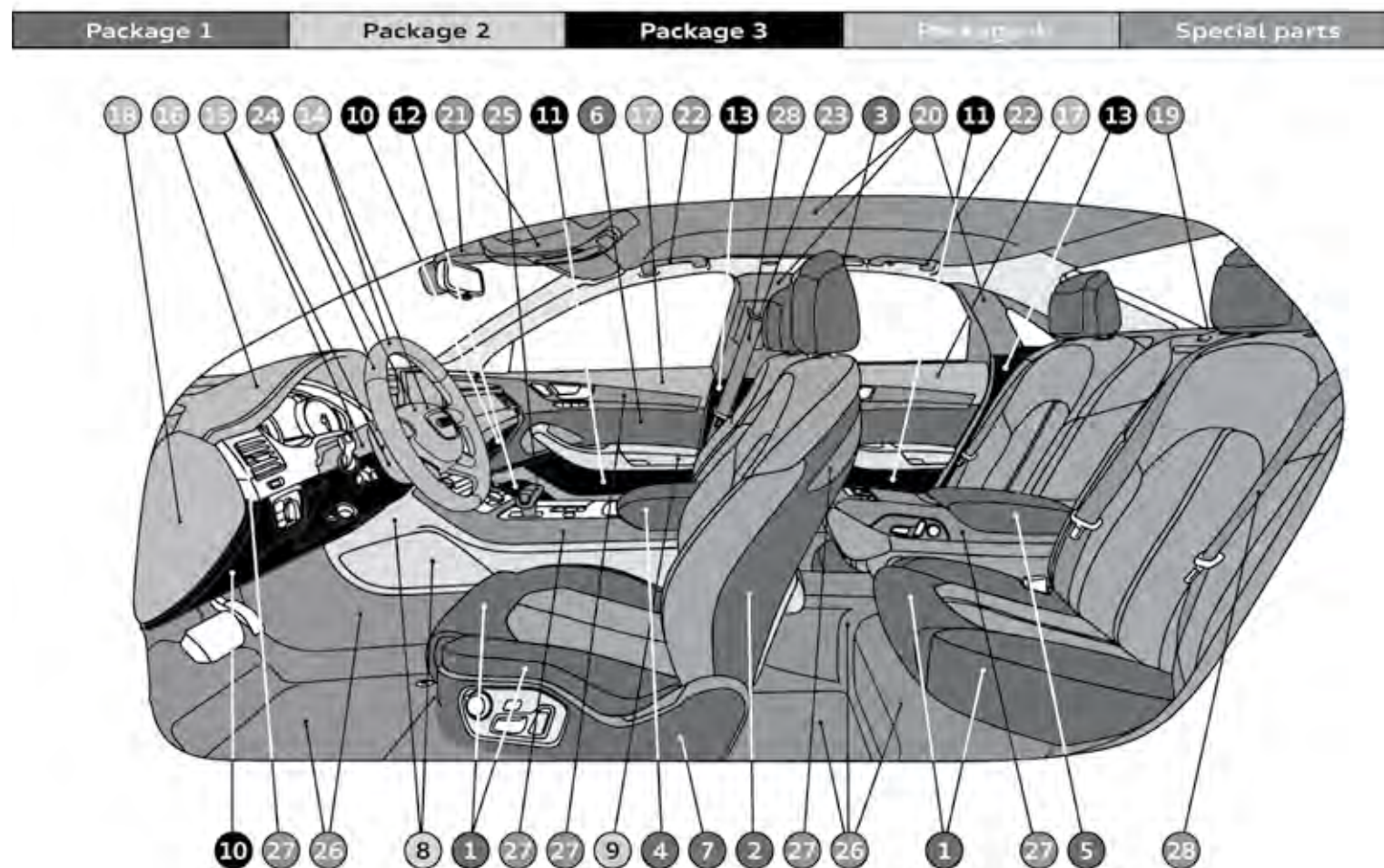

Inlays

Inlays are the all-important finishing touch that add flair and interest to your car's interior, available in a variety of textures and finishes.

Order Code		SE	SE Executive	SE long wheelbase	SE Executive long wheelbase	S8	W12 long wheelbase	Basic RRP	Total RRP inc VAT
5TF	Upper inlays – Fine grain birch wood, pearl beige*	●	●	●	●	●	●	£362.50	£435.00
5TW	Upper inlays – Vavona wood, assam grey*	●	●	●	●	●	●	£362.50	£435.00
7TL	Upper inlays – Fine grain ash, velvet brown*	●	●	●	●	●	●	£362.50	£435.00
5TT	Upper inlays – Piano finish, black*	●	●	●	●	●	–	£708.33	£850.00
GT4	Lower inlay – Brushed aluminium, silver	●	S	●	S	S	S	£333.33	£400.00

Upper inlays

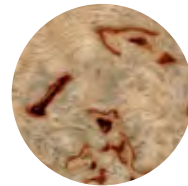

Fine grain birch wood, pearl beige – 5TF



Vavona wood, assam grey – 5TW



Fine grain ash, velvet brown – 7TL

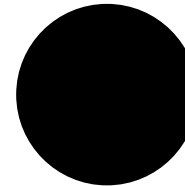

Piano finish, black – 5TT

Lower inlay

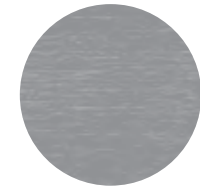

Brushed aluminium, silver** – GT4

Options are subject to availability and may extend delivery.

- = Not available
- = Available
- S = Standard

*Only available in combination with leather gear lever (6Q2) or gear selector lever in wood (6Q3) on S8.

**Only available as a lower inlay.

RRP – Recommended Retail Price.

VAT is calculated at 20% but this may alter to reflect any change in the applicable VAT rate.



Upper inlay in Walnut brown and lower inlay in highly polished Piano finish, black (standard on SE trim)

Inlays

Audi exclusive

Audi exclusive has sourced a wide range of materials which you can select for your inlays, from Oak sepia to Fine grain myrtle nutmeg.

Order Code		SE	SE Executive	SE long wheelbase	SE Executive long wheelbase	S8	W12 long wheelbase	Basic RRP	Total RRP inc VAT
YTA S3G	Audi exclusive inlays (cannot be combined with the inlays shown on page 44)*	•	•	•	•	•	•	£1,533.33	£1,840.00

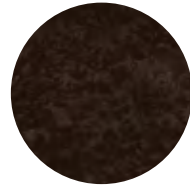

Fine grain myrtle, nutmeg



Fine grain ash, nougat



Oak, sepia

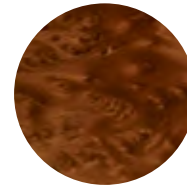

Vavona wood, bronze



Modrone wood, gold



Tamo ash, dark brown

Options are subject to availability and may extend delivery.

- = Not available
- = Available
- S = Standard

*Only available in combination with leather gear selector lever (6Q2) on S8. SMG must also be added.

RRP – Recommended Retail Price.

VAT is calculated at 20% but this may alter to reflect any change in the applicable VAT rate.



Audi exclusive inlays in Oak sepia



Audi exclusive inlays in Fine grain myrtle, nutmeg

Interior design

We've created a range of options so that you can tailor your Audi A8's interior.

Order Code		SE	SE Executive	SE long wheelbase	SE Executive long wheelbase	S8	W12 long wheelbase	Basic RRP	Total RRP inc VAT
7HB	Extended leather package – Fine Nappa leather with decorative stitching on: door armrest, centre console, knee pads and airbag cover on steering wheel	●	●	●	●	–	–	£850.00	£1,020.00
7HC	Extended leather package plus – in addition to leather package (7HB), Fine Nappa leather with decorative stitching on: bottom of door panels, door pockets, bottom of instrument panel including exterior of glove compartment and area surrounding the MMI	●	●	●	●	S	S	£1,829.17	£2,195.00
7HD	Extended leather package advanced – in addition to leather package plus (7HC), Fine Nappa leather with decorative stitching on: top of door, instrument panel cover, front seat backrest cover, front seat bottom trim, dashboard wraparound, front and rear headrest piping. Only in combination with Comfort seats or Comfort Sports seats with an Alcantara package (PL4 or PL7) and electric sunblinds for rear window and rear door windows (3Y8)	●	●	●	●	–	–	£6,466.67	£7,760.00
		–	–	–	–	●	–	£3,362.50	£4,035.00
PL4	Black Alcantara package – the following items in black Alcantara: headlining, A, B, C, D pillars, parcel shelf	●	●	●	●	–	–	£1,275.00	£1,530.00
		–	–	–	–	●	●	No charge	No charge
PL7	Alcantara package – the following items are in Alcantara to match chosen colours: headlining, A, B, C, D pillars, parcel shelf	●	●	●	●	S	S	£1,275.00	£1,530.00
6NQ	Cloth headlining – black	●	●	●	●	–	–	£262.50	£315.00
		–	–	–	–	●	–	No charge	No charge
6Q3	Gear selector lever in wood – wood is matched to chosen upper inlays. Not available in combination with Audi design selection (PEZ/PEX) or Audi exclusive inlays (YTA)	●	●	●	●	–	●	£91.67	£110.00
		–	–	–	–	●	–	No charge	No charge
YSQ S3G	Audi exclusive carpet and floor mats* – with leather piping, front and rear. Not available in combination with Audi exclusive floor mats (YSR)	●	●	●	●	●	●	£1,787.50	£2,145.00
YSR S3G	Audi exclusive floor mats* – with leather piping, front and rear. Not available in combination with Audi exclusive carpet and floor mats (YSQ)	●	●	●	●	●	●	£404.17	£485.00
YSK S3G	Audi exclusive headlining in Alcantara – stitching can be specified in a variety of colours from the Audi exclusive range. Only available in combination with an Alcantara package (PL4 or PL7)	●	●	–	–	●	–	£4,041.67	£4,850.00
		–	–	●	●	–	●	£4,425.00	£5,310.00
YSG S3G	Audi exclusive rear shelf in Alcantara. Only available in combination with electric sunblind for rear window (3Y2) or electric sunblinds for rear window and rear door windows (3Y8)	●	●	●	●	●	●	£979.17	£1,175.00
YTO S3G	Audi exclusive seat belts*	●	●	●	●	●	●	£1,362.50	£1,635.00

Options are subject to availability and may extend delivery.

- = Not available
- = Available
- S = Standard

*The colours of the seat belts, carpet or floor mats with leather piping (where applicable) can be selected from any of the Audi exclusive colours shown on page 40 to match or contrast with the chosen seat colour.

RRP – Recommended Retail Price.

VAT is calculated at 20% but this may alter to reflect any change in the applicable VAT rate.



Audi exclusive inlays (YTA) and Audi exclusive gear selector lever (YTD) in Oak, sepi

Audi design selection

Audi design selection is a unique blend of features, colours and materials. From 22-way adjustable Comfort front seats to four-zone automatic air conditioning, each item means you'll be able to make the most of your driving experience.

Options are subject to availability and may extend delivery.

- = Not available
- = Available
- S = Standard

RRP – Recommended Retail Price.

VAT is calculated at 20% but this may alter to reflect any change in the applicable VAT rate.

Order Code	SE	SE Executive	SE long wheelbase	SE Executive long wheelbase	S8	W12 long wheelbase	Basic RRP	Total RRP inc VAT
Audi design selection Balao brown – an exclusive combination of exquisite interior colours, materials and equipment. The package includes: - 22-way adjustable Comfort front seats (Q2) with memory function (3PR) - Seats in Valcona leather (N5D) with Comfort rear headrests (VA2) in Balao brown with Snow white accordion pleat, piping and contrasting stitching - Headlining in Snow white Alcantara (6NN) - Parcel shelf in Balao brown Alcantara - Top of dashboard in Mocca brown with Snow white/Mocca brown contrast stitching - Lower dashboard in Balao brown	•	-	-	-	-	-	£10,637.50	£12,765.00
PEZ - Upper inlays in Fine grain ash, natural Balsamic brown (7TK) - Lower inlays in brushed aluminium, silver (GT4) - Aluminium look interior (GS4) - Heated front and outer rear seats (4A4) - Ventilation and massage function for front seats (4D5) - Deluxe 4-zone climate control (9AH) - Electric sunblinds for rear window and for rear door windows (3Y8) - Design selection badge in doors - Leather package advanced (7HD) Only available in combination with leather gear selector lever (6Q2) on S8	-	•	-	-	-	-	£10,304.17	£12,365.00
	-	-	•	-	-	-	£9,616.67	£11,540.00
	-	-	-	•	-	-	£9,283.33	£11,140.00
	-	-	-	-	•	•	£6,383.33	£7,660.00

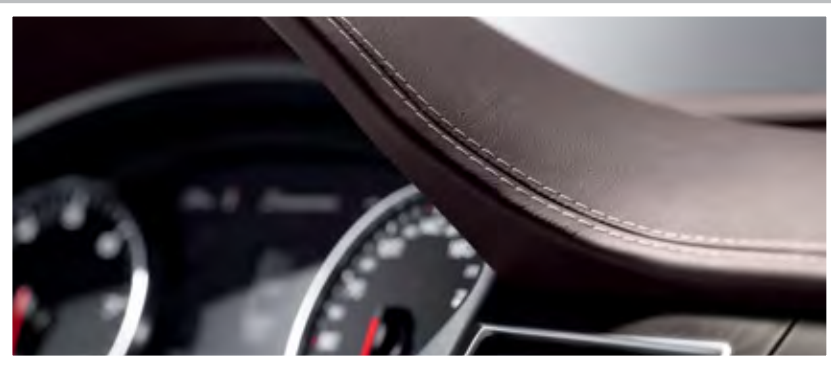

Audi design selection

Order Code	SE	SE Executive	SE long wheelbase	SE Executive long wheelbase	S8	W12 long wheelbase	Basic RRP	Total RRP inc VAT
Audi design selection Granite grey/Brass beige – an exclusive combination of exquisite interior colours, materials and equipment. The package includes: - 22-way adjustable Comfort front seats (Q2) with memory function (3PR) - Seats in Valcona leather (N5D) with Comfort rear headrests (VA2) in Brass beige with Granite grey accordion pleat, piping and contrast stitching - Headlining in Snow white Alcantara (6NN) - Parcel shelf in Brass beige Alcantara - Top of dashboard in Granite grey with Brass beige contrast stitching - Lower dashboard in Brass beige	●	–	–	–	–	–	£10,637.50	£12,765.00
PEX - Upper inlays in Fine grain birch wood, pearl beige (STF) - Lower inlays in brushed aluminium, silver (GT4) - Aluminium-look interior (GS4) - Heated front and outer rear seats (4A4) - Ventilation and massage function for front seats (4D5) - Deluxe 4-zone climate control (9AH) - Design selection badge in doors - Leather package advanced (7HD) Only available in combination with leather gear selector lever (6Q2) or gear selector lever in wood (6Q3) on S8	–	●	–	–	–	–	£10,304.17	£12,365.00
	–	–	●	–	–	–	£9,616.67	£11,540.00
	–	–	–	●	–	–	£9,283.33	£11,140.00
	–	–	–	–	●	●	£6,383.33	£7,660.00

Options are subject to availability and may extend delivery.

- = Not available
- = Available
- S = Standard

RRP – Recommended Retail Price.

VAT is calculated at 20% but this may alter to reflect any change in the applicable VAT rate.



Wheels, tyres and suspension

Choose a set of specially-selected alloy wheels to subtly enhance the way your Audi A8 looks and drives.



19" x 9J '10-spoke Y'
design alloy wheels - PRC



19" x 9J '5-arm'
design alloy wheels - PRD



19" x 9J '5-twin-spoke'
design alloy wheels - PQG



20" x 9J '10-parallel-spoke'
design alloy wheels - PRK



20" x 9J '5-segment-spoke'
design alloy wheels - PQ6



20" x 9J '7-twin spoke'
design bi-colour alloy wheels - PQF

Options are subject to availability and may extend delivery.

Wheels, tyres and suspension

Order Code	SE	SE Executive	SE long wheelbase	SE Executive long wheelbase	S8	W12 long wheelbase	Basic RRP	Total RRP inc VAT
PRC 19" x 9J '10-spoke Y' design alloy wheels with 255/45 R19 tyres	●	S	●	S	-	-	£1,362.50	£1,635.00
	-	-	-	-	-	●	£391.67	£470.00
	●	-	●	-	-	-	£1,362.50	£1,635.00
PRD 19" x 9J '5-arm' design alloy wheels with 255/45 R19 Y tyres	-	●	-	●	-	-	No charge	No charge
	-	-	-	-	-	●	£391.67	£470.00
	●	-	●	-	-	-	£1,791.67	£2,150.00
PQG 19" x 9J '5-twin-spoke' design alloy wheels with 255/45 R19 tyres	-	●	-	●	-	-	£429.17	£515.00
	-	-	-	-	-	●	£820.83	£985.00
	●	-	●	-	-	-	£2,295.83	£2,755.00
PRK 20" x 9J '10-parallel-spoke' design alloy wheels with 265/40 R20 Y tyres	-	●	-	●	-	-	£933.33	£1,120.00
	-	-	-	-	-	●	£1,325.00	£1,590.00
	●	-	●	-	-	-	£2,333.33	£2,800.00
PQ6 20" x 9J '5-segment-spoke' design alloy wheels with 265/40 R20 tyres	-	●	-	●	-	-	£970.83	£1,165.00
	-	-	-	-	●	-	£720.83	£865.00
	-	-	-	-	-	●	£1,362.50	£1,635.00
	●	-	●	-	-	-	£2,708.33	£3,250.00
PQF 20" x 9J '7-twin spoke' design bi-colour alloy wheels with 265/40 R20 tyres	-	●	-	●	-	-	£1,345.83	£1,615.00
	-	-	-	-	●	-	£1,095.83	£1,315.00
	-	-	-	-	-	●	£1,737.50	£2,085.00
	●	-	●	-	-	-	£2,708.33	£3,250.00

Options are subject to availability and may extend delivery.

- = Not available
● = Available
S = Standard

RRP – Recommended Retail Price.

VAT is calculated at 20% but this may alter to reflect any change in the applicable VAT rate.

Wheels, brakes and suspension



20" x 9J '7-twin spoke' design high-gloss
finish alloy wheels - PQN



21" x 9J '5-arm rotor' design titanium
finish alloy wheels - PQU



21" x 9J '5-arm rotor' design with high-gloss
finish alloy wheels - PQW



21" x 9J '5-arm structure' design alloy
wheels - PQM



21" x 9J '5-triple spoke S' design alloy
wheels - PRJ

Options are subject to availability
and may extend delivery.

Wheels, brakes and suspension

Order Code		SE	SE Executive	SE Long wheelbase	SE Executive Long wheelbase	S8	W12 Long wheelbase	Basic RRP	Total RRP inc VAT
PQN	20" x 9J '7-twin spoke' design high-gloss finish alloy wheels with 265/40 R20 tyres	●	—	●	—	—	—	£2,983.33	£3,580.00
		—	●	—	●	—	—	£1,620.83	£1,945.00
		—	—	—	—	●	—	£1,370.83	£1,645.00
		—	—	—	—	—	●	£2,012.50	£2,415.00
PQU	21" x 9J '5-arm rotor' design in titanium finish alloy wheels with 275/35 R21 tyres	●	—	●	—	—	—	£3,000.00	£3,600.00
		—	●	—	●	—	—	£1,637.50	£1,965.00
		—	—	—	—	●	—	£1,387.50	£1,665.00
		—	—	—	—	—	●	£2,029.17	£2,435.00
PQW	21" x 9J '5-arm rotor' design with high-gloss finish alloy wheels with 275/35 R21 tyres	●	—	●	—	—	—	£2,916.67	£3,500.00
		—	●	—	●	—	—	£1,554.17	£1,865.00
		—	—	—	—	●	—	£1,304.17	£1,565.00
		—	—	—	—	—	●	£1,945.83	£2,335.00
PQM	21" x9J '5-arm structure' design alloy wheels with 275/35 R21 tyres	●	—	●	—	—	—	£2,916.67	£3,500.00
		—	●	—	●	—	—	£1,554.17	£1,865.00
		—	—	—	—	●	—	£1,304.17	£1,565.00
		—	—	—	—	—	●	£1,945.83	£2,335.00
PRJ	21" x9J '5-triple spoke S' design alloy wheels with 265/35 R21 tyres	—	—	—	—	●	—	£1,304.17	£1,565.00
2MA	Sports air suspension with electronic shock absorption control – stiffer damping. Vehicle height can be decreased by up to 10mm. Increased functionality through Audi drive select	●	●	●	●	—	●	£716.67	£860.00
GH2	quattro with Sports differential. The electronically regulated Sports differential distributes power individually between the back wheels, giving outstanding handling characteristics (standard on 4.2 TDI models). Not available on 3.0 TDI (204PS)	●	●	●	●	S	●	£979.17	£1,175.00
1N7	Dynamic steering. Steering angle and steering torque requirement adjusted dependent on road speed. Can also be adjusted through Audi drive select. ESP uses the dynamic steering function along with the brakes when the vehicle is over or under-steering to apply active steering interventions	●	●	●	●	S	●	£1,108.33	£1,330.00
1G3	Full sized spare alloy wheel with tyre. Only in combination with 19" or 20" alloy wheels. Please note that the boot space is reduced with this option. Not available on 3.0 TDI (204PS)	●	●	●	●	—	●	£358.33	£430.00
PCS	Ceramic brakes. 19-inch high-performance braking system with carbon fibre-reinforced ceramic brake discs in front and rear. Includes specially designed cooling ducts in the ventilated and perforated brake discs, brake callipers in high gloss anthracite, and 'Audi ceramic' inscription to front callipers. Not available on 3.0 TDI or 3.0 TFSI. Not available in combination with 18" alloy wheels	●	●	●	●	●	●	£7,208.33	£8,650.00

Options are subject to availability and may extend delivery.

— = Not available
● = Available
S = Standard

RRP – Recommended Retail Price.

VAT is calculated at 20% but this may alter to reflect any change in the applicable VAT rate.

Audio and communication

Stay in touch using our range of advanced communication functions, and give each journey its own soundtrack with our audio equipment, including a Bang & Olufsen Advanced Sound System and the class-leading Rear Seat Entertainment System.

Options are subject to availability and may extend delivery.

¹To check the compatibility of your mobile phone and whether it has SIM Access Profile compatibility, please visit www.audi.co.uk/owners-area/phone-compatibility.html

²Please note that when a data SIM card is inserted into the SIM card reader, Bluetooth handsfree connectivity is disabled as the SIM card takes priority over the Bluetooth connection.

³Online services are only available for mobile phone contracts including a data option and only within the coverage of the mobile phone network; there may be additional costs for the use of these services (charges and billing correspond to the personal mobile phone contract). Due to high data volumes, a mobile phone contract including an unlimited data plan is strongly recommended. The content and scope of the online-based services offered may vary.

- = Not available
• = Available
S = Standard

RRP – Recommended Retail Price.

VAT is calculated at 20% but this may alter to reflect any change in the applicable VAT rate.

Order Code		SE	SE Executive	SE long wheelbase	SE Executive long wheelbase	S8	W12 long wheelbase	Basic RRP	Total RRP inc VAT
9ZF	Mobile telephone preparation – Low with Bluetooth. Provides handsfree connection via Bluetooth using mobile phone aerial. Alternatively, it can use a cradle with charging facility for optimal reception via external aerial. Cradle available at extra cost – please contact your Audi Centre for phone compatibility	•	•	•	•	-	-	£145.83	£175.00
9ZW	Mobile telephone preparation – High with Audi connect. A mobile phone can be connected to the internal UMTS (3G) module via Bluetooth (provided the mobile telephone has SIM Access Profile ¹), or alternatively through the additional SIM card reader ² . It is possible to transfer phone book entries to the car and manage call lists. Audi connect features include: navigation using Google Earth images and Google Street View, destination entry via Google Maps or myAudi, online point of interest search and information services such as weather forecasts and the latest world news. Audi connect also includes Audi traffic information online, which gives accurate real-time forecasts of the traffic situation along the chosen route. The traffic situation can be displayed on the navigation map or Google Earth image. Audi connect can also create a Wi-Fi hotspot in the car for convenient internet access using a mobile device (e.g. laptop or tablet) ³ . Many Audi connect features can be simply operated via MMI Navigation Plus, the multi-function steering wheel or the voice control system	•	•	•	•	S	S	£291.67	£350.00
9ZW QF2	Mobile telephone preparation – High with Audi connect and Bluetooth privacy handset located in front centre armrest. The cordless handset allows passengers to make private calls, providing remote control of the telephone functions as well as a convenient SMS text message function. The handset is charged from a docking station integrated into the front centre armrest	•	•	•	•	-	S	£691.67	£830.00
		-	-	-	-	•	-	£400.00	£480.00
9ZW QF4	Mobile telephone preparation – High with Audi connect and Bluetooth privacy handsets located in front and rear centre armrests. The cordless handsets allow passengers to make private calls, providing remote control of the telephone functions as well as a convenient SMS text message function. The handset is charged from a docking station integrated into the armrest. Only in combination with deluxe 4-zone climate control (9AH)	•	•	•	•	-	-	£1,095.83	£1,315.00
		-	-	-	-	•	-	£804.17	£965.00
		-	-	-	-	-	•	£404.17	£485.00
QU6	TV reception - digital. TV tuner for reception of 'free-to-air' TV channels. Picture display only possible on MMI screen when vehicle is stationary, audio available at all times. Reception dependent upon local digital network availability. Only in combination with BOSE® (8RY) or Bang & Olufsen (8RF) sound systems	•	•	•	•	•	•	£1,108.33	£1,330.00
6G0	CD/DVD changer for 6 DVDs and/or CDs (MP3, WMA, AAC and WMV formats) located in the glovebox	•	•	•	•	S	S	£554.17	£665.00
8RY	BOSE® surround-sound system - 14 high-performance speakers - Dashboard – two tweeters and a centre speaker - Front doors – two bass modules with BOSE® Acoustic Wave Speaker Technology and two mid-range speakers - Rear doors – two mid-range speakers in doors and two tweeters in the B-pillars - Parcel shelf – a subwoofer and two surround-sound speakers - 12-channel DSP amplifier with over 600-Watt output located in boot - Surround-sound reproduction from digital 5.1 recordings (DVD) and from stereo sources (CD, Radio, MP3) via the patented BOSE® Centerpoint 2 technology (speaker trim design with chromed plastic frames, protector and BOSE® logo)	•	•	•	•	S	S	£979.17	£1,175.00

Audio and communication

Order Code	SE	SE Executive	SE long wheelbase	SE Executive long wheelbase	S8	W12 long wheelbase	Basic RRP	Total RRP inc VAT
Bang & Olufsen advanced sound system - 19 high-performance speakers including subwoofer: - Dashboard – 100mm centre speaker, 19mm tweeter and two surround-sound speakers - Front doors – two 100mm mid-range speakers and two 165mm woofers - Rear doors – four 100mm mid-range speakers and two tweeters - Parcel shelf – subwoofer, two surround-sound speakers and two tweeters	•	•	•	•	–	–	£5,616.67	£6,740.00
	–	–	–	–	•	•	£4,637.50	£5,565.00
8RF								
Rear Seat Entertainment - Two 10.2" high-resolution LCD monitors (only 16mm thick) on the backrest of the front seats, fixed with adjustable brackets. - Separate MMI control unit in rear centre armrest - Separate main unit in rear with additional single DVD drive, hard drive (20GB for media; maximum 4,000 tracks in MP3 format), two SD card slots, Audi Music Interface, AUX-IN and AV-IN (for external games console, for example)	•	•	•	•	•	•	£3,191.67	£3,830.00
9WP								
- Audio supports MP3, WMA and AAC formats - Video supports MPEG-1, -2, -4, WMV and Xvid formats - Access to radio, TV and DVD changer - Two wireless Bluetooth headphones - Option of different content on each screen - 5.1 surround-sound possible Only in combination with Comfort front seats (PS8) or Comfort front Sports seats (PS1) and BOSE® (8RY) or Bang & Olufsen (8RF) sound systems. Only in combination with deluxe 4-zone climate control (9AH) on S8								

Options are subject to availability and may extend delivery.

– = Not available

• = Available

S = Standard

RRP – Recommended Retail Price.

VAT is calculated at 20% but this may alter to reflect any change in the applicable VAT rate.



Rear Seat Entertainment with Audi design selection Balao brown and Bang & Olufsen advanced sound system

Safety and security

We've developed a range of advanced technologies to increase your safety. For example, pre-sense can detect an imminent collision and tighten the seat belts, close the sunroof and windows, and activate the hazard warning lights to alert other drivers.

Options are subject to availability and may extend delivery.

- = Not available
- = Available
- S = Standard

RRP - Recommended Retail Price.

VAT is calculated at 20% but this may alter to reflect any change in the applicable VAT rate.

Order Code		SE	SE Executive	SE long wheelbase	SE Executive long wheelbase	S8	W12 long wheelbase	Basic RRP	Total RRP inc VAT
7Y2	Audi lane assist. Uses a discreet camera mounted at the top of the windscreen to monitor the road ahead, and the driver is warned with a vibration of the steering wheel if the vehicle is about to exit its lane unintentionally (at speeds over 38mph). Only in combination with a 4-spoke multi-function steering wheel (2Z5 or 2ZD)	•	•	•	•	•	•	£425.00	£510.00
PCH	Audi side assist including pre-sense rear. Aids the driver when changing lane. Audi side assist monitors the area behind your car, using radar sensors located discreetly in the rear bumper, and informs the driver with a visual warning signal in the door mirror if there is a vehicle in their blind spot or approaching quickly from behind. The system is activated using a button in the driver's door and works at speeds above 19mph. Pre-sense rear uses the rear sensors, and if a rear collision is sensed, the upper backrest and headrest are adjusted automatically and the airbags are pre-conditioned to provide increased protection. When combined with Comfort front Sports seats (PS1) the pneumatic bolsters are also filled to provide more protection	•	•	•	•	•	•	£695.83	£835.00
PCH 7Y3	Audi side assist and Audi lane assist including pre-sense rear. Combines the functionality of Audi lane assist and Audi side assist including pre-sense rear. Only in combination with a 4-spoke multi-function steering wheel (2Z5 or 2ZD)	•	•	•	•	•	•	£954.17	£1,145.00
PCG	Adaptive cruise control (ACC) with Stop&Go function including pre-sense front. Automatic distance regulation, using radar sensors to maintain required distance by braking and accelerating. Four programs (distance 1 to distance 4) can be set via the steering column controls of the cruise control system. Works at speeds between 0 and 155mph and also includes Audi braking guard system which triggers a visual and acoustic alarm when the system detects the risk of a collision with the vehicle in front. In addition, the airbags are pre-conditioned if a crash is sensed and the braking system is prepared to assist with the necessary braking force once the brake pedal is touched	•	•	•	•	•	•	£1,704.17	£2,045.00

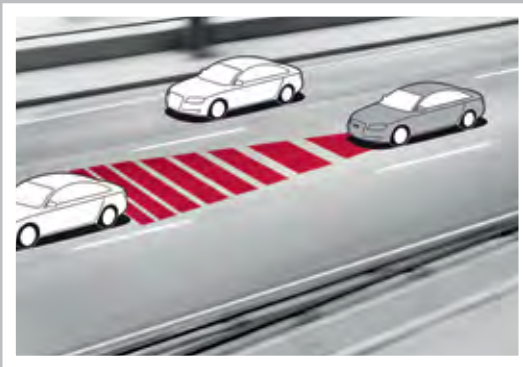

Adaptive cruise control

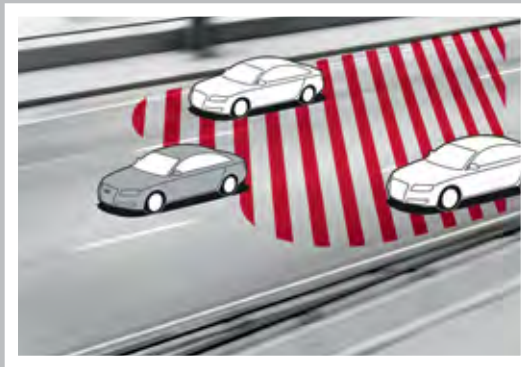

Audi side assist

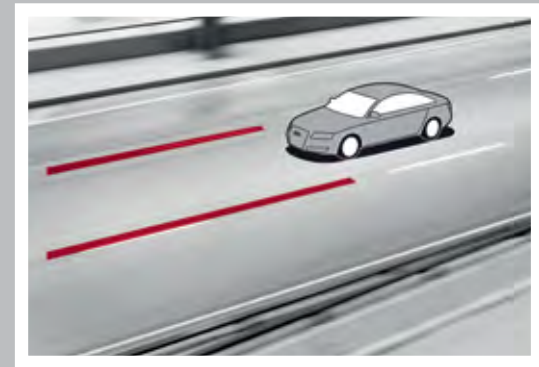

Audi lane assist

Safety and security

Order Code		SE	SE Executive	SE long wheelbase	SE Executive long wheelbase	S8	W12 long wheelbase	Basic RRP	Total RRP inc VAT
	Audi Assist package with pre-sense plus and Audi lane assist Includes: - Audi adaptive cruise control with Stop&Go function including pre-sense front - Audi lane assist - Audi side assist including pre-sense rear - Pre-sense plus, an expansion of the Audi braking guard, where if a collision is classified as unavoidable the brakes are applied automatically in order to minimise the impact of the collision. Only in combination with a 4-spoke multi-function steering wheel (2ZS or 2ZD)	●	●	●	●	●	●	£2,825.00	£3,390.00
PCN 7Y3									
KA2	Audi parking system advanced with reversing camera. Aids parking by acoustically and visually indicating distances to obstacles with guiding lines. Measured by sensors and reversing camera	●	S	●	S	S	S	£425.00	£510.00
KA6	Audi parking system advanced with top view. Aids parking and manoeuvring using 4 cameras. Cameras are mounted in the front grille, the handle of the boot lid and the housing of the two exterior mirrors. The driver can choose between different image representations in the MMI display, including a live "bird's eye view" image for parking	●	-	●	-	-	-	£1,066.67	£1,280.00
		-	●	-	●	●	●	£614.67	£770.00
PXB	Adaptive light and high-beam assist. Includes swivelling headlights for improved illumination of a winding road, and dynamic cornering light function which pivots the headlights based on the movement of the steering wheel (operational between speeds of approximately 6mph and 68mph). Turning light function is activated when indicator is switched on (up to speeds of 45mph). The headlights have three different light distribution modes: town light, motorway light, or country light, which are adjusted according to speed or via navigation route data. Additional functionality via navigation-based vehicle support includes junction light, which provides a wide front light setting, as well as travel mode, which switches between right and left-hand drive modes assisted by GPS data. High-beam assist automatically adjusts headlights from high-beam to dipped-beam when another vehicle is approaching or when other ambient lighting is detected (i.e. street lights) by a camera on the interior mirror. Not available in combination with all-LED headlights including high-beam assist (PX2)	●	●	●	●	-	-	£695.83	£835.00

Options are subject to availability and may extend delivery.

- = Not available
- = Available
- S = Standard

RRP – Recommended Retail Price.

VAT is calculated at 20% but this may alter to reflect any change in the applicable VAT rate.



Audi parking system advanced with top view



Adaptive light and high-beam assist

Safety and security

Order Code		SE	SE Executive	SE long wheelbase	SE Executive long wheelbase	S8	W12 long wheelbase	Basic RRP	Total RRP inc VAT
PX2	All-LED headlights including high-beam assist. LEDs for all front lighting functions. LED technology provides lower energy consumption and enhanced contrast with a colour similar to daylight, for increased safety and good recognition by other road users. Includes all-weather light function to reduce the risk of the driver being dazzled when visibility is poor (in fog, rain or snow), turning light function which is activated when indicator is switched on (up to speeds of 45mph), and an additional motorway light which automatically increases headlight range at speeds above approximately 68mph. Also includes high-beam assist which automatically adjusts headlights from high-beam to dipped-beam when another vehicle is approaching or when other ambient lighting is detected (i.e. street lights) by a camera on the interior mirror. Not available in combination with Adaptive light and high-beam assist (PXB)	●	●	●	●	S	S	£1,533.33	£1,840.00
9R1	Night vision assistant with pedestrian detection. A thermal imaging camera (remote infrared with resolution of 320x240 pixels) registers heat dissipation in front of the vehicle and represents this image in the 7" Driver's Information System display. Image recognition software highlights people detected in the darkness in yellow, and if the system classifies them as being at risk, a warning bell is sounded and the image changes to red. If combined with Adaptive light and high-beam assist (PXB) the person detected is also illuminated by the headlights three times in succession to alert them to the danger. System operation may be restricted in too much ambient light, high humidity and high night time temperatures (over 28°C)	●	●	●	●	●	●	£1,704.17	£2,045.00
QR9	Speed limit display – the prevailing speed limit can be simply read from the Driver's Information System. Should the camera fail to see a sign properly, the speed limit from the data for the navigation system will be shown instead. The specific advantages are: - Display of the speed limits currently registered, which can be called up in the Driver's Information System at any time - Display can be called up in every instrument cluster view - Camera-based system is also capable of detecting temporary speed restrictions in roadworks and on digital displays (e.g. over motorways) within the system limits - Display of national speed limits for Western European countries Only available with Audi lane assist (7Y2), adaptive cruise control (PCG), or Audi assist package with pre-sense plus and Audi lane assist (PCN/7Y3)	●	●	●	●	●	●	£129.17	£155.00

Options are subject to availability and may extend delivery.

- = Not available
- = Available
- S = Standard

RRP – Recommended Retail Price.

VAT is calculated at 20% but this may alter to reflect any change in the applicable VAT rate.



All-LED headlights

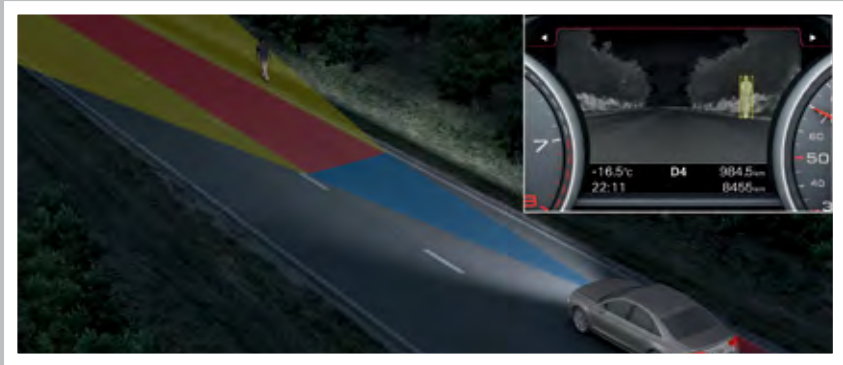

Night vision assistant with pedestrian detection



Interior equipment

Specify every detail of your car's interior with this range of options.

Order Code		SE	SE Executive	SE long wheelbase	SE Executive long wheelbase	S8	W12 long wheelbase	Basic RRP	Total RRP inc VAT
PGD	Advanced key with Audi hands-free boot opening system. Access and authorisation system which automatically exchanges data between key and vehicle, allowing the driver to keep the key in their pocket or bag at all times. To unlock and open, simply lift the exterior door handle. To lock, press the button on the handle. Pressing the start/stop button integrated in the centre console starts and stops the engine. A simple foot movement underneath the rear bumper triggers the boot lid to open automatically	●	S	●	S	S	S	£829.17	£995.00
9AH	Deluxe 4-zone climate control including rear comfort centre armrest As standard climate control plus: - Separate air distribution and temperature controls for driver, front passenger and both sides in the rear - Additional air-conditioning controls in the rear comfort centre armrest	●	●	S	S	●	S	£1,020.83	£1,225.00
3Y2	Electric sunblind for rear window	●	●	—	—	●	—	£416.67	£500.00
3Y8	Electric sunblinds for rear window and for rear door windows	●	●	S	S	●	S	£850.00	£1,020.00
VC1	Garage door opener (Homelink®*). Programmable radio-operated remote control for compatible doors/gates. Control buttons integrated in the front roof module	●	●	●	●	●	●	£208.33	£250.00
3X1	Through-load facility. For transporting long objects	●	●	●	●	●	●	£287.50	£345.00
1W7	Cool box. Compressor-based cooling located in the through-load facility with temperature range from +10°C to -15°C, capacity for two 0.75l bottles horizontally, shelf and LED interior lighting. Can be converted back to through-load facility with ski bag at any time. Cannot be combined with through-load facility. Not available on 3.0 TDI (204PS)	●	●	●	●	●	●	£1,062.50	£1,275.00
8S3	Additional reading lights. Two additional rear reading lights. Only available in combination with electric slide-and-tilt sunroof (3FE) or electric slide-and-tilt solar-panel sunroof (3FR)	●	●	—	—	●	—	£129.17	£155.00
VE1 853	Rear vanity mirror. Includes two additional rear reading lights	—	—	●	●	—	S	£229.17	£275.00
YZV S3G	Audi exclusive Cardan reading lights. Two swivelling LED rear reading lights. Only available in combination with electric slide-and-tilt sunroof (3FE) or electric slide-and-tilt solar-panel sunroof (3FR)	●	●	●	●	●	●	£833.33	£1,000.00
1U6	Audi exclusive folding table for driver side for working comfortably in the rear of the vehicle. Simple manual operation. The folding table is made of high-quality wood which matches the selected inlay in the vehicle. Only available in combination with Comfort front seats (PS8) or Comfort front Sports seats (PS1). Only available in combination with wood inlays on S8	●	●	●	●	●	●	£1,062.50	£1,275.00
1U7	Audi exclusive folding table for passenger side for working comfortably in the rear of the vehicle. Simple manual operation. The folding table is made of high-quality wood which matches the selected inlay in the vehicle. Only available in combination with Comfort front seats (PS8) or Comfort front Sports seats (PS1). Only available in combination with wood inlays on S8	●	●	●	●	●	●	£1,062.50	£1,275.00
1U9	Audi exclusive folding table for driver and passenger side for working comfortably in the rear of the vehicle. Simple manual operation. The folding table is made of high-quality wood which matches the selected inlay in the vehicle. Only available in combination with Comfort front seats (PS8) or Comfort front Sports seats (PS1). Only available in combination with wood inlays on S8	●	●	●	●	●	●	£2,083.33	£2,500.00
YXA S3G	Personalisation of Audi exclusive folding table for driver's side. Includes the personalisation of one Audi exclusive folding table by engraving the front and back of the table to include your initials, the A8 logo or any other design of your choice**. The engraving can be seen when the table is folded open and closed. Only available in combination with an Audi exclusive folding table (1U6, 1U7 or 1U9)	●	●	●	●	●	●	£804.17	£965.00

Options are subject to availability and may extend delivery.

— = Not available
● = Available
S = Standard

*HomeLink® is a registered trademark of Johnson Controls. For information on compatibility, visit www.homelink.com.

**Designs are subject to factory approval.

RRP – Recommended Retail Price.

VAT is calculated at 20% but this may alter to reflect any change in the applicable VAT rate.

Interior equipment

Specify every detail of your car's interior with this range of options.

Options are subject to availability and may extend delivery.

- = Not available
- = Available
- S = Standard

*Leather and stitching (where applicable) can be specified in a variety of colours from the Audi exclusive range. Unless an Audi exclusive colour is selected the foot rests will be colour matched to the carpet colour.

**Please note that this is a European 2-pin socket and may carry some restrictions.

RRP - Recommended Retail Price.

VAT is calculated at 20% but this may alter to reflect any change in the applicable VAT rate.

Order Code		SE	SE Executive	SE long wheelbase	SE Executive long wheelbase	S8	W12 long wheelbase	Basic RRP	Total RRP inc VAT
5N2	Folding grab handles with wood segments. Not available in combination with upper inlays - Fine grain ash, natural Balsamic brown (7TK) or upper inlays - Fine grain birch wood, pearl beige (5TF). Not available in combination with Audi exclusive inlays (YTA)	•	•	•	•	•	S	£437.50	£525.00
YSX S3G	Audi exclusive folding grab handles with wood segments. Only available in combination with Audi exclusive inlays (YTA). Not available in Tamo ash dark brown	•	•	•	•	•	•	£875.00	£1,050.00
YTD S3G	Audi exclusive gear selector lever in wood. Only available in combination with matching Audi exclusive inlays (YTA)	•	•	•	•	•	•	£283.33	£340.00
YTR S3G	Audi exclusive rear foot rests. Includes two individual foot rests located in the lower section of the front seat backrests, enabling passengers to travel more comfortably in the rear. Only available in combination with an Audi exclusive carpet (YSQ)*	-	-	•	•	-	•	£225.00	£270.00
OTR	Rear foot rests	-	-	•	•	-	•	£208.33	£250.00
9Z3	230V socket. Only available as part of a rear seat package (PE1 or PE2)**	-	-	•	•	-	•	£129.17	£155.00
9JA	Non-smoking package. Replaces cigarette lighter with one 12V socket in the front and rear	•	•	•	•	•	•	No charge	No charge



Rear vanity mirror



Folding grab handles with wood segments

Exterior equipment

Make sure your car looks exactly as you want it to by selecting some of the striking options from our detailed list.

Order Code		SE	SE Executive	SE long wheelbase	SE Executive long wheelbase	S8	W12 long wheelbase	Basic RRP	Total RRP inc VAT
3FE	Electric slide-and-tilt sunroof. Includes position pre-selection, tinted glass insert, variable sunshield and convenience closing	●	●	S	S	●	S	£1,208.33	£1,450.00
3FR	Electric slide-and-tilt solar-panel sunroof. Includes position pre-selection and convenience closing. Uses the sun's energy to supply a constant flow of air to reduce the temperature inside a parked car	●	●	—	—	●	—	£1,575.00	£1,890.00
PPA	Panoramic sunroof. Includes rear vanity mirror. Not available on 3.0 TDI (204PS)	—	—	●	●	—	●	£1,362.50	£1,635.00
GZ2	Power door closure. Electrically-operated power doors with soft-close feature	●	●	●	●	●	S	£545.83	£655.00
4E7	Power-operated boot lid. Opens and closes the boot lid electrically. Opened via radio-operated remote car key, button in the driver's door or the soft-touch button in the boot-lid recess. Closed by pressing the button on the inside of the boot lid	●	S	●	S	S	S	£512.50	£615.00
4KS	Privacy glass. Dark tinted glass from B-pillar backwards	●	●	●	●	●	—	£375.00	£450.00
PDG	Twin-pane UV and heat-insulating glass. Please note that the reflective layer may impede the operation of portable GPS, GSM or road-toll devices. Only in combination with mobile telephone preparation – Low (9ZF) or mobile telephone preparation – High (9ZW). Not available in combination with privacy glass (4KS)	●	●	●	●	●	S	£425.00	£510.00
PDB	Twin-pane UV, heat-insulating glass and heated windscreen. Includes invisible heating element in windscreen. Operates automatically below +5°C when climate control is on auto. Please note that the reflective layer may impede the operation of portable GPS, GSM or road-toll devices. Only in combination with mobile telephone preparation – Low (9ZF) or mobile telephone preparation – High (9ZW). Not available in combination with privacy glass (4KS)	●	●	●	●	●	—	£766.67	£920.00
PDJ	Twin-pane UV, heat insulating privacy glass and heated windscreen. Includes invisible heating element in windscreen. Operates automatically below +5°C when climate control is on auto. Please note the reflective layer may impede the operation of portable GPS, GSM or road-toll devices. Only in combination with mobile preparation – Low (9ZF) or mobile preparation – High (9ZW)	●	●	●	●	●	—	£1,141.67	£1,370.00
1D9	Towing bracket – electrically folding. Electrically folding ball head operated via button in the luggage compartment, including trailer stabilisation via the Electronic Stability Programme. Not available in combination with panoramic sunroof. Includes single European 13-pin electrics socket and may require a 13- to 7-pin adaptor*. Please contact your Audi Centre for details. Not available on 3.0 TDI (204PS)	●	●	●	●	●	●	£979.17	£1,175.00
2Z7	Deletion of engine technology and quattro badges at rear	●	●	●	●	—	●	No charge	No charge
2Z0	Deletion of model designation, engine technology and quattro badges at rear	●	●	●	●	●	●	No charge	No charge

Options are subject to availability and may extend delivery.

— = Not available
● = Available
S = Standard

*Additional wiring is required for auxiliary equipment.

RRP – Recommended Retail Price.

VAT is calculated at 20% but this may alter to reflect any change in the applicable VAT rate.



Steering wheels

Our steering wheels are available in a range of textures and designs and can give you control of key vehicle features such as phone and stereo, as well as the automatic transmission.

Options are subject to availability and may extend delivery.

- = Not available
 ● = Available
 S = Standard

*In any of the Audi exclusive colours shown on page 40.

RRP – Recommended Retail Price.

VAT is calculated at 20% but this may alter to reflect any change in the applicable VAT rate.

Order Code		SE	SE Executive	SE long wheelbase	SE Executive long wheelbase	S8	W12 long wheelbase	Basic RRP	Total RRP inc VAT
2ZS	4-spoke leather multi-function steering wheel with gear-shift paddles. Only in combination with Audi lane assist (7Y2), Audi side and lane assist (PCH/7Y3) or Audi Assist package (PCN/7Y3)	S	S	S	S	●	S	No charge	No charge
1XX	3-spoke leather multi-function steering wheel with gear-shift paddles	●	●	●	●	S	●	£150.00	£180.00
1XT	Heated 3-spoke leather multi-function steering wheel with gear-shift paddles	●	●	●	●	–	●	£358.33	£430.00
		–	–	–	–	●	–	£208.33	£250.00
2ZD	Heated 4-spoke leather multi-function steering wheel with gear-shift paddles. Only in combination with Audi lane assist (7Y2), Audi side and lane assist (PCH/7Y3) or Audi Assist package (PCN/7Y3) on S8	●	●	●	●	●	●	£208.33	£250.00
6F9	4-spoke multi-function steering wheel with wood segments and gear-shift paddles. Available in Walnut brown only. Only in combination with Walnut brown inlays (SMG). Not available in combination with a heated steering wheel or Audi lane assist	●	●	●	●	●	–	£512.50	£615.00
YRB S3G	Audi exclusive controls package*. Includes leather-covered steering wheel and gear-shift gaiter	●	●	●	●	●	●	£741.67	£890.00
YRH S3G	Audi exclusive leather-covered steering wheel*	●	●	●	●	●	●	£554.17	£665.00

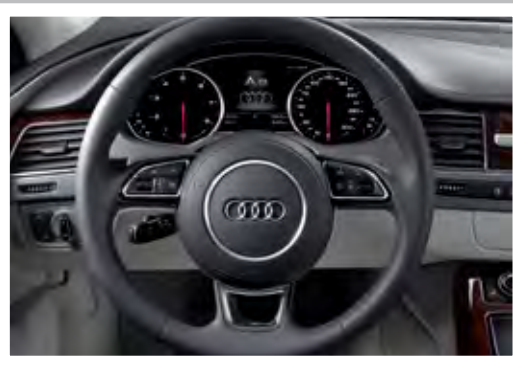

3-spoke leather multi-function steering wheel



4-spoke leather multi-function steering wheel

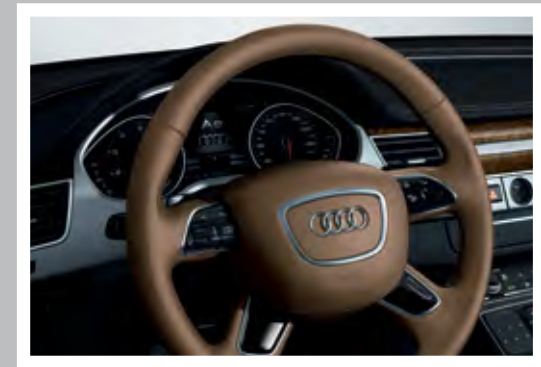

Audi exclusive 4-spoke leather multi-function steering wheel in Havana brown



Audi Complete

Audi Complete is simply a way to look after the servicing and maintenance costs for your Audi in a single package. You pay a one-off or monthly fee and we'll cover all your servicing, maintenance and tyres for the next three years, including your first MOT and a full 5-year warranty. It means you only have to pay for fuel, insurance and your Road Fund Licence. So you can be reassured that your car will be maintained by trained Audi Technicians, using genuine Audi parts.

*Retail customers only. Pricing based on 3 years/30,000 miles (whichever occurs sooner). All pricing is a 'starting from' price for the Audi A8 model range and therefore subject to change and mileage/model dependent

Service Plan

Choosing an Audi Service Plan provides an easy way to cover all your car's scheduled servicing with a one-off payment. It can take care of everything from fluid and filter changes to your full service, ensuring you retain a full Audi service history. There are no servicing bills to plan for and you'll continue to benefit from today's prices for the length of your agreement.

Options are subject to availability and may extend delivery.

- = Not available
 ● = Available
 S = Standard

RRP - Recommended Retail Price.

VAT is calculated at 20% but this may alter to reflect any change in the applicable VAT rate.

Order Code		A8	S8	W12 long wheelbase	Basic RRP	Total RRP inc VAT
AC1	Audi Complete - Service, Maintenance and 5-year warranty. Comprehensive care for your Audi covering all your servicing and maintenance for 3 years, as well as your first MOT and a full 5-year/90,000 mile warranty. Visit your local Audi Centre for further information or audi.co.uk/audicomplete for full details including terms and conditions	●	-	-	£63.33	£76.00*
		-	-	●	£69.17	£83.00*
		-	●	-	£74.17	£89.00*
AC2	Audi Complete - Service, Maintenance, Tyres and 5-year warranty. Comprehensive care for your Audi covering all your servicing, maintenance and tyres for 3 years, as well as your first MOT and a full 5-year/90,000 mile warranty. Visit your local Audi Centre for further information or audi.co.uk/audicomplete for full details including terms and conditions	●	-	-	£83.33	£100.00*
		-	-	●	£94.17	£113.00*
		-	●	-	£114.17	£137.00*

Order Code		A8	S8	W12 long wheelbase	Basic RRP	Total RRP inc VAT
-	Service Plan. Comprehensive service package, valid for 3 years or 60,000 miles (whichever occurs sooner) including parts and labour charges. Servicing is provided as defined in the Audi Service Schedules. Transferable between owners (within the period of original agreement). For full details of cover and exclusions, please speak to a member of staff at your Audi Centre	●	-	●	£250.00	£300.00

Warranty

All new Audi models now come with a choice of a three, four or five year warranty*. What's more, if you decide to sell your Audi before the warranty expires, it will be fully transferred to the new owner. So, whichever length of warranty you choose, you can forget about unexpected repair bills and enjoy several years of carefree driving.

Options are subject to availability and may extend delivery.

- = Not available
 ● = Available
 S = Standard

*Three year warranty consists of a two-year unlimited mileage warranty and a third year warranty with a 60,000 mile limitation. Four year warranty consists of two-years' unlimited mileage coverage, and two further years' coverage with a 75,000 mile limitation. Five year warranty consists of two-years' unlimited mileage coverage, and three further years' coverage with a 90,000 mile limitation.

**Only available prior to registration of your Audi A8. Please speak to your Audi Centre for full details.

RRP – Recommended Retail Price.

VAT is calculated at 20% but this may alter to reflect any change in the applicable VAT rate.

Order Code		A8	S8	W12 long wheelbase	Basic RRP	Total RRP inc VAT
-	Audi Warranty covering you for unlimited mileage in the first two years of ownership, and up to 60,000 miles in the third year. Transferable between owners**	S	S	S	No charge	No charge
EA6	Audi Warranty covering you for up to 4 years or 75,000 miles, whichever comes soonest. Cover includes a two-year unlimited mileage warranty, and up to 75,000 miles in the third and fourth years. Transferable between owners**	●	●	●	£862.50	£1,035.00
EA9	Audi Warranty covering you for up to 5 years or 90,000 miles, whichever comes soonest. Cover includes a two-year unlimited mileage warranty, and up to 90,000 miles in the third, fourth and fifth years. Transferable between owners**	●	●	●	£2,129.17	£2,555.00

Merchandise

From the enthusiast's motorsport collection to the sophisticated Audi collection, there's a wide variety of adults' and children's clothing, lifestyle accessories and collectables, all of which bear the Audi name.

Please speak to a member of our team at your local Audi Centre to see the full Audi collection and to place an order. A selection of Audi merchandise is also available to buy from audi.co.uk/merchandise.



Audi kids



Bags and leather goods



Clothing



Motorsports



Sport and travel



Model cars

A8 technical data

Engine	Petrol		Diesel		
	3.0 TFSI quattro	58 quattro	3.0 TDI	3.0 TDI quattro	4.2 TDI quattro
Transmission	8-speed tiptronic	8-speed tiptronic	8-speed tiptronic	8-speed tiptronic	8-speed tiptronic
Cylinder	6-cylinder	8-cylinder	6-cylinder	6-cylinder	8-cylinder
Displacement, cubic cm	2995	3993	2967	2967	4134
Max. power ¹ , PS at rpm	290/4850-6500	520/6000	204/3750-4500	250/4000-4500	350/4000
Max. torque, Nm at rpm	420/2500-4850	650/1700-5500	400/1250-3500	550/1500-3000	800/1750-2750
0-62mph acceleration, seconds	6.1	4.2	7.9	6.1	5.5
Top speed ² , mph	155*	155*	146	155*	155*
CO ₂ emissions ³ , g/km	204	235	158	169	195
Benefit in kind (BIK)%	31%	35%	25%	27%	33%
Fuel consumption ³ , mpg (l/100km) Urban	24.1 (11.7)	19.6 (14.4)	38.2 (7.4)	35.8 (7.9)	30.4 (9.3)
Fuel consumption ³ , mpg (l/100km) Extra Urban	39.8 (7.1)	37.2 (7.6)	54.3 (5.2)	50.4 (5.6)	44.8 (6.3)
Fuel consumption ³ , mpg (l/100km) Combined	32.1 (8.8)	28.0 (10.1)	47.1 (6.0)	44.1 (6.4)	38.2 (7.4)
ABI insurance group 1-50	43E	TBC	40E	43E	47E
Unladen weight ⁴ , kg	1830	1975	1795	1840	1995
Gross weight limit, kg	2520	2575	2505	2530	2660
Roof load limit/nose weight, kg	100/95	100/95	100/N/A	100/95	100/95
Max trailer load unbraked ⁵ , kg	750	750	N/A	750	750
Max trailer load with 12% gradient ⁵ , kg	2300	2300	N/A	2200	2300
Max trailer load with 8% gradient ⁵ , kg	2300	2300	N/A	2200	2300
Luggage compartment capacity, litres	510	510	510	510	510
Fuel tank capacity approx, litres	90	90	90	90	90

*Electronically limited

¹The given value was obtained in accordance with the specified measurement procedure (the respective current version of the Directive 80/1269/EEC).

²Regulated

³Fuel consumption and CO₂ emissions figures are obtained under standardised test conditions (Directive 93/116/EEC) using a representative model. This allows direct comparison between different models from different manufacturers, but may not represent the actual fuel consumption achieved in 'real world' driving conditions. More information is available at www.vca.gov.uk.

⁴Vehicle unladen weight without driver (calculated in accordance with the current version of Directive 80/1268/EEC). The fitting of additional equipment may increase the vehicle's unladen weight and drag coefficient, whereupon the potential carrying capacity and top speed will be correspondingly reduced.

⁵The engine's power output always goes down with increasing altitude. At 1,000m above sea level, and for every additional 1,000m, deduct 10% from the weight of the outfit (trailer load limit + gross weight of the towing vehicle).

A8 long wheelbase technical data

	Petrol			Diesel	
	4.0 TFSI quattro	6.3 W12 quattro	3.0 TDI	3.0 TDI quattro	4.2 TDI quattro
Engine	4.0 TFSI quattro	6.3 W12 quattro	3.0 TDI	3.0 TDI quattro	4.2 TDI quattro
Transmission	8-speed tiptronic	8-speed tiptronic	8-speed tiptronic	8-speed tiptronic	8-speed tiptronic
Cylinder	8-cylinder	12-cylinder	6-cylinder	6-cylinder	8-cylinder
Displacement, cubic cm	3993	6299	2967	2967	4134
Max. power ¹ , PS at rpm	420/5000	500/6200	204/3750-4500	250/4000-4500	350/4000
Max. torque, Nm at rpm	600/1500-4500	625/4750	400/1250-3500	550/1500-3000	800/1750-2750
0-62mph acceleration, seconds	4.7	4.7	8.0	6.2	5.6
Top speed ² , mph	155*	155*	146	155*	155*
CO ₂ emissions ³ , g/km	221	277	161	171	198
Benefit in kind (BIK)%	35%	35%	26%	28%	33%
Fuel consumption ³ , mpg (l/100km) Urban	21.6 (13.1)	17.0 (16.6)	37.7 (7.5)	35.8 (7.9)	30.1 (9.4)
Fuel consumption ³ , mpg (l/100km) Extra Urban	38.2 (7.4)	31.0 (9.1)	53.3 (5.3)	49.6 (5.7)	44.1 (6.4)
Fuel consumption ³ , mpg (l/100km) Combined	29.7 (9.5)	23.7 (11.9)	46.3 (6.1)	43.5 (6.5)	37.7 (7.5)
ABI insurance group 1-50	46E	50E	41E	44E	47E
Unladen weight ⁴ , kg	1945	2055	1845	1890	2045
Gross weight limit, kg	2595	2655	2505	2540	2670
Roof load limit/nose weight, kg	100/95	100/95	100/N/A	100/95	100/95
Max trailer load unbraked ⁵ , kg	750	750	N/A	750	750
Max trailer load with 12% gradient ⁵ , kg	2300	2300	N/A	2200	2300
Max trailer load with 8% gradient ⁵ , kg	2300	2300	N/A	2200	2300
Luggage compartment capacity, litres	510	510	510	510	510
Fuel tank capacity approx, litres	90	90	90	90	90

*Electronically limited

¹The given value was obtained in accordance with the specified measurement procedure (the respective current version of the Directive 80/1269/EEC).

²Regulated

³Fuel consumption and CO₂ emissions figures are obtained under standardised test conditions (Directive 93/116/EEC) using a representative model. This allows direct comparison between different models from different manufacturers, but may not represent the actual fuel consumption achieved in 'real world' driving conditions. More information is available at www.vca.gov.uk.

⁴Vehicle unladen weight without driver (calculated in accordance with the current version of Directive 80/1268/EEC). The fitting of additional equipment may increase the vehicle's unladen weight and drag coefficient, whereupon the potential carrying capacity and top speed will be correspondingly reduced.

⁵The engine's power output always goes down with increasing altitude. At 1,000m above sea level, and for every additional 1,000m, deduct 10% from the weight of the outfit (trailer load limit + gross weight of the towing vehicle).

A8 dimensions

The technical drawings opposite show the exact dimensions of the Audi A8, so you can check everything - from whether the car will fit in your garage to whether your luggage will fit in the boot.

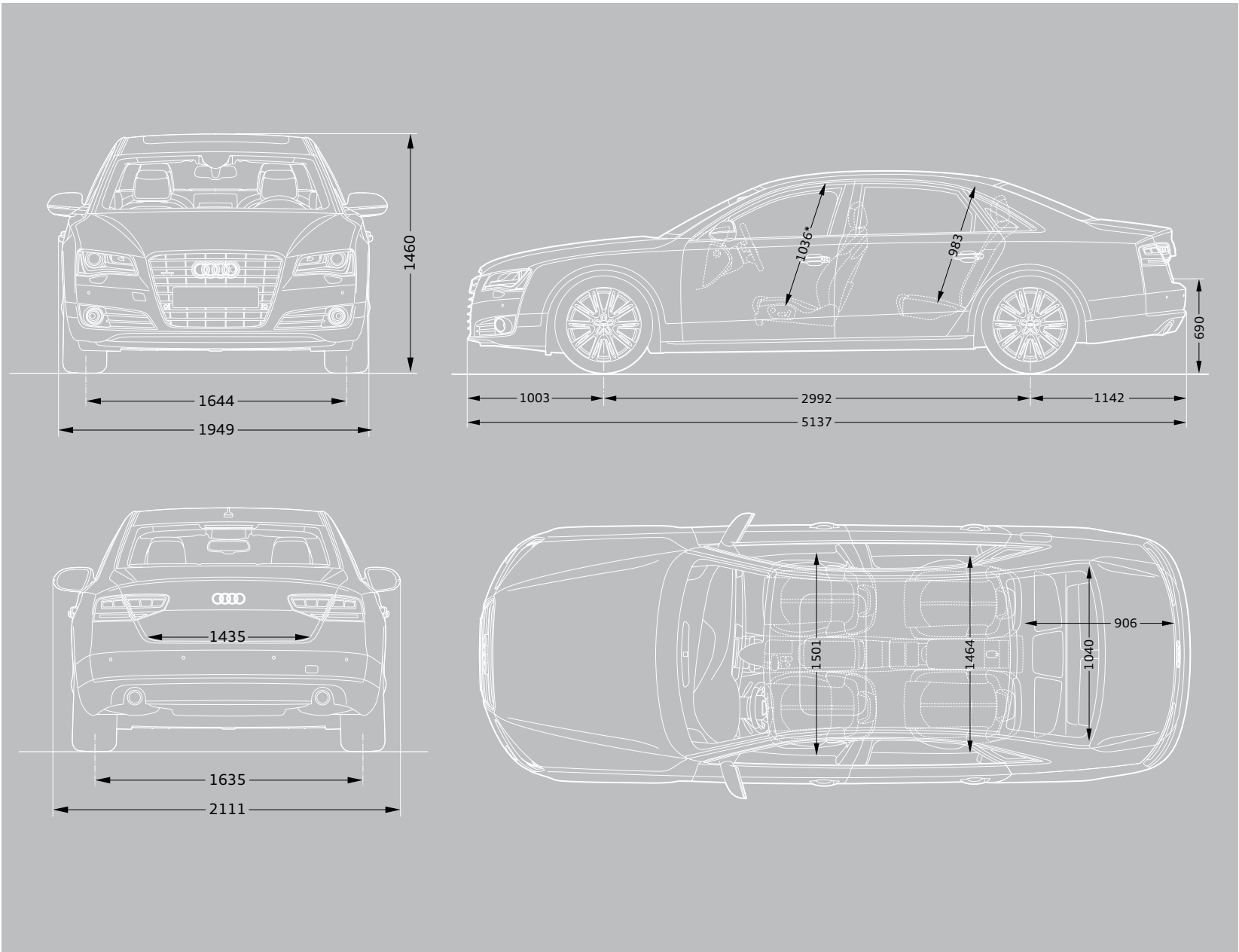

*Maximum headroom.

Dimensions in millimetres.

Turning circle approx 12.3 metres.

Dimensions were measured with vehicle at unladen weight, ground clearance measured with vehicle carrying its maximum load. Luggage compartment volume in litres: 500 (as measured by the VDA standard test method using 200 x 100 x 50mm blocks).

A8 long wheelbase dimensions

The technical drawings opposite show the exact dimensions of the Audi A8 long wheelbase, so you can check everything – from whether the car will fit in your garage to whether your luggage will fit in the boot.

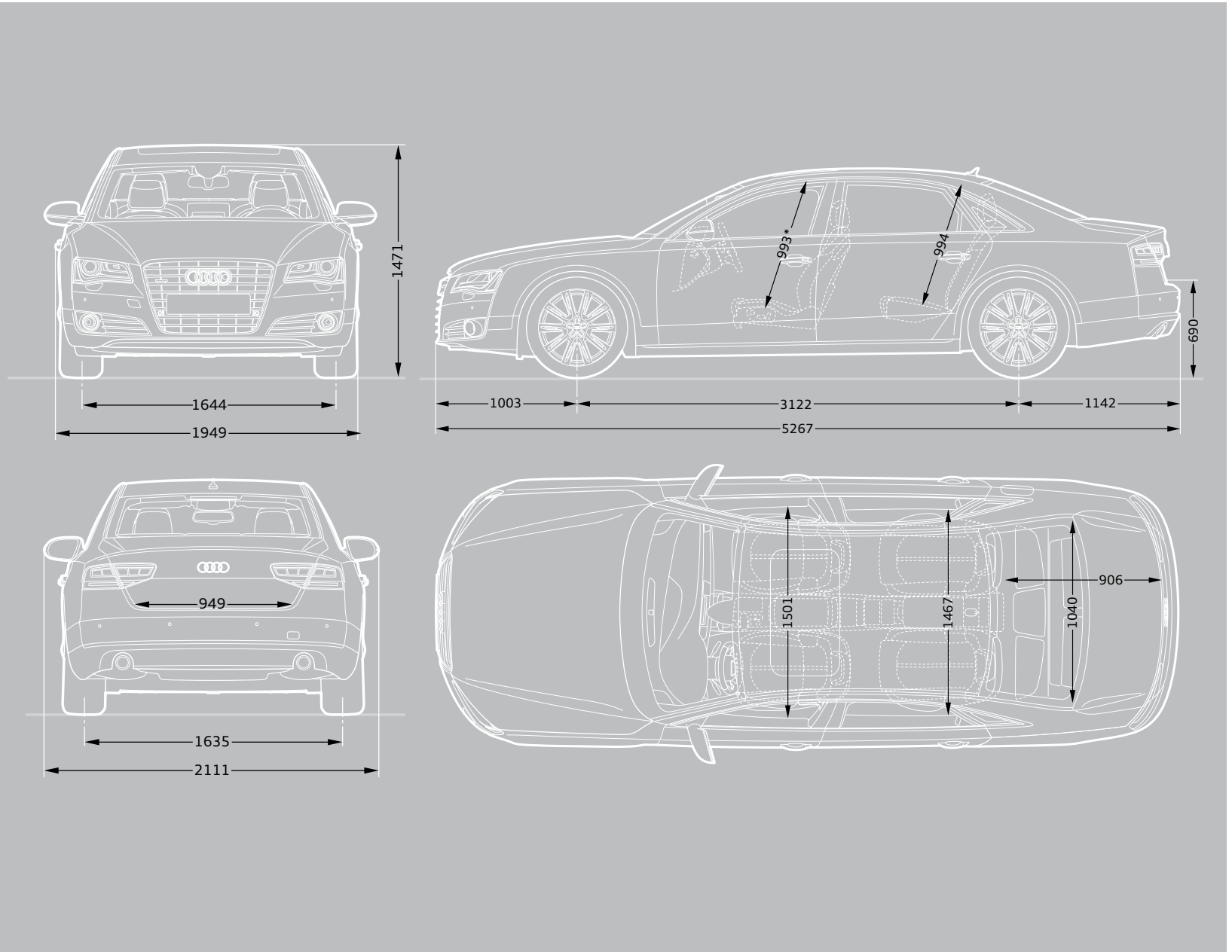

*Maximum headroom.

Dimensions in millimetres.

Turning circle approx 12.3 metres.

Dimensions were measured with vehicle at unladen weight, ground clearance measured with vehicle carrying its maximum load. Luggage compartment volume in litres: 500 (as measured by the VDA standard test method using 200 x 100 x 50mm blocks).

S8 dimensions

The technical drawings opposite show the exact dimensions of the Audi S8, so you can check everything – from whether the car will fit in your garage to whether your luggage will fit in the boot.

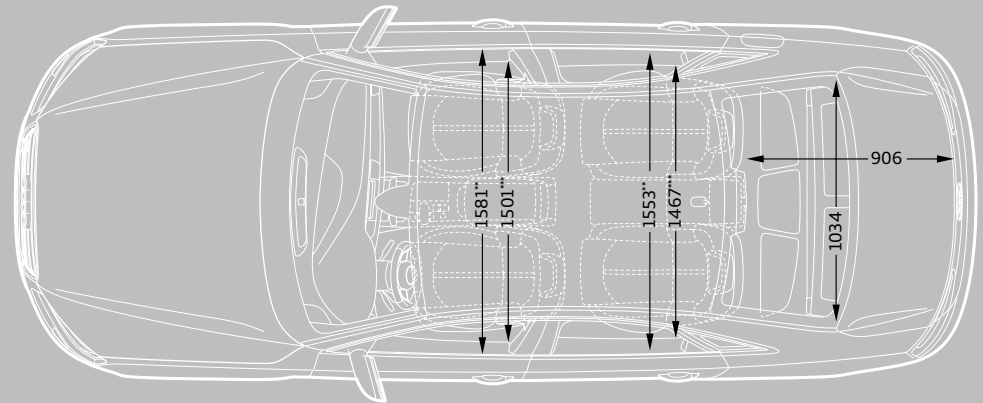
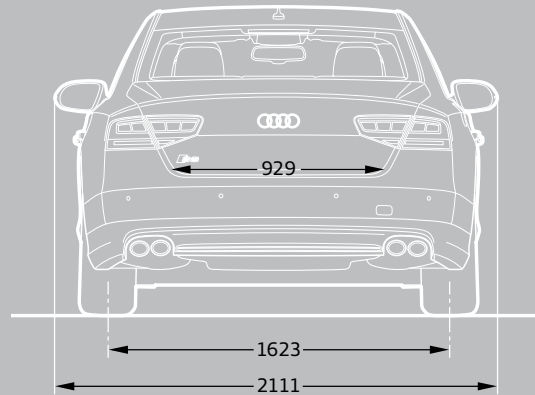
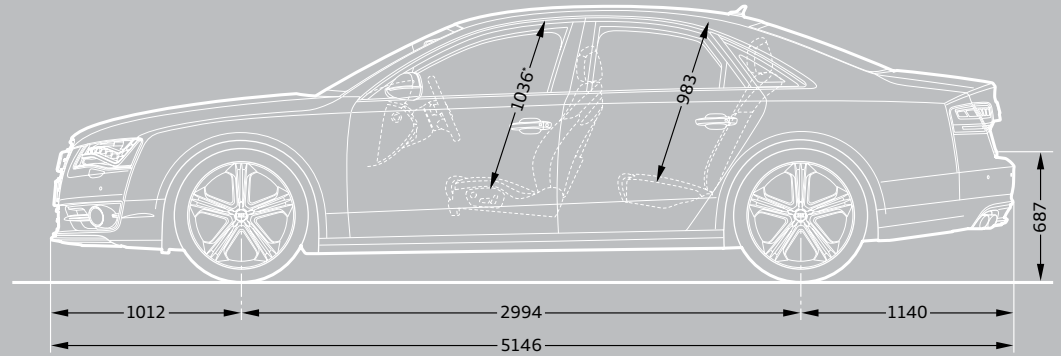
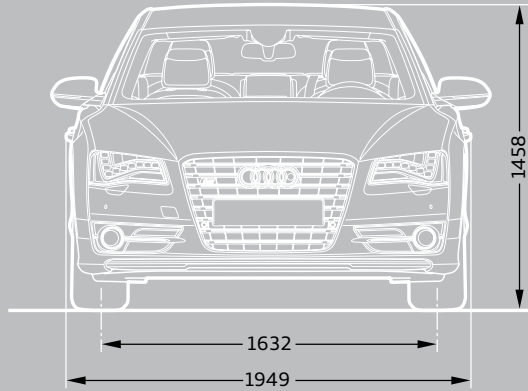

*Maximum headroom.

**Elbow room width.

***Shoulder room width.

Dimensions in millimetres.

Turning circle approx 12.3 metres.

Dimensions were measured with vehicle at unladen weight, ground clearance measured with vehicle carrying its maximum load. Luggage compartment volume in litres: 500 (as measured by the VDA standard test method using 200 x 100 x 50mm blocks).

Additional information

CO₂ data and information

CO₂ emissions-based Vehicle Excise Duty

Vehicle Excise Duty (Road Fund Licence) is based upon the amount of Carbon Dioxide (CO₂) a vehicle emits, measured in grams per kilometre (g/km). First year VED rates apply to the first year of ownership. Annual VED rates apply thereafter. The DVLA has created thirteen categories:

Petrol and Diesel engines	First year	Annual rate (second year onwards)
A – up to 100g/km	£0.00	£0.00
B – 101 to 110g/km	£0.00	£20.00
C – 111 to 120g/km	£0.00	£30.00
D – 121 to 130g/km	£0.00	£100.00
E – 131 to 140g/km	£120.00	£120.00
F – 141 to 150g/km	£135.00	£135.00
G – 151 to 165g/km	£170.00	£170.00
H – 166 to 175g/km	£275.00	£195.00
I – 176 to 185g/km	£325.00	£215.00
J – 186 to 200g/km	£460.00	£250.00
K – 201 to 225g/km	£600.00	£270.00
L – 226 to 255g/km	£815.00	£460.00
M – over 255g/km	£1,030.00	£475.00

Vehicle Excise Duty (VED) rates correct at time of going to print, but these may alter to reflect any change in the applicable VED rate

Servicing tailored to your needs

Regular servicing is key to safeguarding your Audi's performance and a full Audi service history could help you preserve the future re-sale value. To make servicing easy, the Audi Service Schedules have been designed to work with your individual driving style and vehicle.

There are two schedules available and your Audi Centre will advise which schedule is most suited to your needs. The conventional fixed Audi Inspection Service Schedule has fixed intervals for the Oil-change and Inspection Service that are based on

time and distance, whichever comes first. With the Audi LongLife Service Schedule, sensors take account of driving style and conditions in which the vehicle is used to indicate when the Oil-change Service is required. Oil-change Service intervals are therefore variable and are conveniently indicated via the on-board service interval display.

Audi Complete

Your vehicle should be placed on the following service schedules dependent on your mileage per annum:

- ▶ Under 10,000 miles per annum – Fixed Inspection Service Schedule
- ▶ Over 10,000 miles per annum – LongLife Service Schedule

Fixed Inspection Service Schedule

	Vehicle usage:
Mileage	Less than 10,000 miles per annum
Type of journey	Mainly city/town centre driving. Short journeys
Conditions	Frequent cold starts. High engine loading – e.g. frequent hill climbs, vehicle fully loaded, towing
Driving style	Uneconomical – e.g. heavy acceleration, heavy braking, constant changes in speed, constant use of high revs, 'sporty' driving
	Service Intervals:
Oil-change Service	Fixed to every 9,000* miles/1 year
Inspection Service	Fixed to every 19,000* miles/2 years

Variable LongLife Service Schedule

	Vehicle usage:
Mileage	More than 10,000 miles per annum
Type of journey	Motorway and main road driving. Mainly longer distance journeys. Constant speeds
Conditions	Normal engine loading – e.g. with little or no towing, with little or no hill climbs. Normal vehicle loading
Driving style	Moderate acceleration, moderate braking, engine revs mainly below 3,000
	Service Intervals:
Oil-change Service	Variable to a maximum of every 19,000* miles/2 years
Inspection Service	Fixed to every 19,000* miles/2 years

*As indicated by the service interval display. Mileages are approximate as the Service Indicator system uses kilometres as its distance measurement.

Additional information

Welcome to Audi

By placing an order for your Audi, you're choosing to get behind the wheel of one of the most sophisticated cars on the road. And because we believe the service we offer should be just as advanced, we wanted to let you know exactly what you can expect from us, now and in the future.

We've agreed a set of standards with all our Centres, which governs the way we do business with you. It outlines the kind of service we promise to deliver for every customer, right down to filling each new Audi we sell with half a tank of fuel.

So whether you're interested in the date your car will arrive in the UK or the way we'll dispose of non-biodegradable materials after we service your Audi, you can have total confidence in us.

Audi Promise

Audi Centres

We guarantee that all of our Centres will be open as follows:

Sales: Monday to Friday 9am–6pm
Saturday 9am–5pm

Service: Monday to Friday 8am–6pm
Saturday 8.30am–1pm

Sunday opening is at local discretion.

New car delivery

Once we've confirmed a delivery date for your car, we'll keep you informed of progress. Subject to reasonable notice, we'll then deliver it to a place of your choice, whether that's your home or place of work. In the unlikely event of a delay, we'll provide a courtesy car to minimise inconvenience and keep you mobile.

The experts in Vorsprung durch Technik

Would you entrust your Audi to anyone who hasn't been regularly trained to Audi standards? Our network of Audi Approved Master Technicians have undergone an impressive 100,000 hours of training over a 10-year programme to ensure they have the latest technical expertise for maintaining and servicing your Audi. All of our Service Advisors undergo a specialist induction and training to ensure they are Audi professionals and able to talk to you about any issues you may have with your Audi vehicle. What's more, we have so much expertise and experience in looking after Audi vehicles that we are able to make a note of your mileage and the state of your vehicle as and when we see it and predict when certain key events may occur. As part of our commitment to you, we will notify you in plenty of time so you can make an appointment with us.

Your convenience comes first

At Audi you can choose from a range of convenient services that suit your needs. Why not book a 'service while you wait' appointment* and enjoy our complimentary refreshments while your car is with us? Or, if you need to be mobile, take advantage of one of our courtesy cars which we can even collect and deliver to you.* We guarantee we can service your Audi within 5 days without a courtesy car, or within 10 days if you need transport. We will also ensure your car is returned to you with a full valet.

Audi Genuine Parts

Would you put a part into your Audi that wasn't the same quality as the factory fitted original? You can rest assured that only Audi Genuine Parts will be used on your vehicle. What's more, Audi parts and labour come with a 2-year guarantee.** We stock a wide variety of parts, so we are well covered. However, if we don't have a part in stock at our Centre we have the back-up of parts at other Audi Centres, at our national warehouse and our factory and can usually source the relevant part very quickly.

We don't like surprises either

We believe strongly in transparency and there will be no hidden costs. For added peace of mind, we will give you a quotation over the phone for the work you have requested and email you the price confirmation. We'll consult you if any additional work on your car is needed when it is with us. We won't carry out any extra work without asking your permission first.

The Audi Stamp

Regular servicing is key to safeguarding your Audi's performance and a full Audi service history could help you preserve the future re-sale value of your car. Only the Audi Stamp will prove your approved Audi service history.

Getting better every time

We continually gather feedback from our Audi Trained Technicians, as well as our customers, to ensure our vehicles are running as they should. Whenever we see an Audi for a service, we connect it directly to our headquarters in Ingolstadt which enables us to check your car's software and make sure it's as up-to-date as possible. If the factory has released a software upgrade for your model, it can be applied immediately – improving anything from your car's efficiency to the precision of its parking system.

Environmental commitment

We promise to dispose of all non-biodegradable materials from your vehicle in a responsible manner.

*Subject to availability.

**Excludes wear and tear.

Pricing information

Pricing

Prices and specifications given are correct at the time of printing. Always check details with your Audi Centre, as Audi policies are continually developing. We reserve the right to change prices or specifications at any time.

All prices are subject to VAT, currently charged at 20% but this may alter to reflect any change in the applicable VAT rate.

Delivery charges and number plates are not included in the vehicle price.

Delivery charge	£471.66
Number plate	£20.00
VAT	£98.34
Total	£590.00

Audi Roadside Assistance

Your new car comes complete with complimentary roadside assistance and recovery across the UK provided by RAC Motoring Services. Also included is roadside assistance throughout Europe, managed by RAC Motoring Services.

For further information and terms and conditions please visit audi.co.uk

Audi Customer Care

Every new Audi benefits from the comprehensive Audi Customer Care Package, which comprises:

- ▶ A 3-year Audi warranty, which covers you for unlimited mileage in the first 2 years of ownership, with a full mechanical and electrical warranty which covers you for up to 60,000 miles in the 3rd year

- ▶ A 3-year paint warranty
- ▶ A 12-year anti-corrosion warranty
- ▶ 3 years' UK roadside assistance and recovery

You also have the option when ordering your new car of choosing a four-year or five-year Audi warranty. Speak to a member of the sales team for more information.

Audi Tax-Free Sales

If you are entitled to purchase a vehicle free of VAT, normally through Military or Diplomatic privilege, please contact your local Audi Centre for full details.

Should you have any difficulty obtaining the information you require, please call Freephone 0800 585878.

Audi Finance

Audi Finance specialise in providing funding solutions for Audi drivers. Whether your Audi is for private or business use, there are a range of funding options to choose from.

Below is the full range of finance products.

- ▶ Solutions – a Personal Contract Plan
- ▶ Hire purchase
- ▶ Lease purchase
- ▶ Finance lease
- ▶ Contract hire

With all products, you can choose a fixed-cost maintenance plan designed to help you budget accurately.

No matter what Audi model you choose, your local Audi Centre can provide you with a personalised quote which could fit your budget and motoring needs.

Audi Finance is a trading name of Volkswagen Financial Services (UK) Limited. An offer of finance depends on certain conditions. Available to people over 18 in the UK only.

Audi Insurance

We want you to start enjoying your new car from day one and thanks to Audi Insurance complimentary seven day cover, you can. Call free on 0800 316 7893 (lines are open Monday to Friday 8am - 9pm, and Saturday 9am - 5pm), provide a few details and a cover note will be sent to your Audi Centre. They will then tax your car and you can drive it away.

Audi Insurance is a trading name of Volkswagen Insurance Service (Great Britain) Limited, an appointed representative of Volkswagen Financial Services (UK) Limited, Brunswick Court, Yeomans Drive, Blakelands, Milton Keynes MK14 5LR. Registered in England number 2835230. Audi Insurance is sold, underwritten and administered by Allianz Insurance plc registered in England number 84638. Registered office 57 Ladymead, Guildford, Surrey GU1 1DB. Volkswagen Financial Services (UK) Limited and Allianz Insurance plc are authorised and regulated by the Financial Services Authority. Volkswagen Financial Services (UK) Limited and Allianz Insurance plc are not part of the same corporate group.

Audi UK

Customer Services
Selectapost 29
Sheffield
S97 3FG
0800 699888
audi.co.uk

Specifications and prices subject
to change without notice.

© Audi (UK)

Printed in the UK
Edition 7.1 06/12
2013 Model Year

