



**The new Audi RS 3 Sportback**

Pricing and Specification Guide

Valid from May 2012

# Personalising your Audi RS 3

This guide has been designed to help you tailor and price your Audi RS 3 quickly and logically. At the back, you will find information on CO2 emissions-based taxation and the other services offered by Audi, including Finance and Insurance. You can also configure your Audi RS 3 online at [audi.co.uk](http://audi.co.uk).

You might also like to consider Audi Complete: a simple way to take care of servicing and maintenance costs for your Audi in a single package. You pay a one-off or monthly fee and we'll cover all your servicing, maintenance and tyres for the next three years including your first MOT and a full 5-year warranty. It means you only have to pay for fuel, insurance and your Road Fund Licence. So you can be reassured that your car will be maintained by trained Audi Technicians, using genuine Audi parts.

**Audi Complete™**

## The Audi RS 3 Sportback

Engine	8
Transmission and brakes quattro®	9
	10

## Model details and prices

Standard model equipment	12
Model prices	14

## Colour and upholstery

Paint	16
Upholstery	18
Colour and trim guide	19
Inlays	22

## Options

Wheels and tyres	24
Audio and communication	26
Interior equipment	27
Seats	28
Exterior equipment	29
Safety and security	30
Audi Complete and warranty	32
Merchandise	33
Accessories	34

## Technical details

Technical data	35
Dimensions	36
Additional information	37
Pricing information	39





## Vorsprung durch Technik

Three words that express the very essence of Audi. Vorsprung durch Technik isn't a slogan. It's our way of seeing the world. It is the driving force behind our history of innovation that continues into the 21st century. Indeed, many technologies that Audi pioneered remain in our cars today. Some are milestones in the history of

the motorcar. From our beginnings in 1899, to the Auto Union team's Grand Prix successes in the 1930s and our more recent wins at Le Mans, we have always been at the forefront of the motor industry.

Vorsprung durch Technik makes us who we are. To see more of its influence, just read on.

## **The Audi RS 3 Sportback: built on our racing heritage**

In the world of Audi motorsport, there are few things more evocative than the letters RS. Over the years, our RS models have provided a showcase for some of our most advanced technologies and pioneering designs – and the Audi RS 3 Sportback is no different.

With its 5-cylinder 2.5-litre turbocharged engine and 7-speed S tronic® transmission, it's capable of 0-62mph in just 4.6 seconds and produces a remarkable 340PS of power. It also has the latest version of our quattro® all-wheel-drive system, delivering outstanding handling and performance in all conditions. And with features including 19-inch alloy wheels, RS exterior body styling and flared front wheel arches made from lightweight carbon-fibre reinforced plastic, the RS 3 has looks to match all the racing prowess that its name suggests.

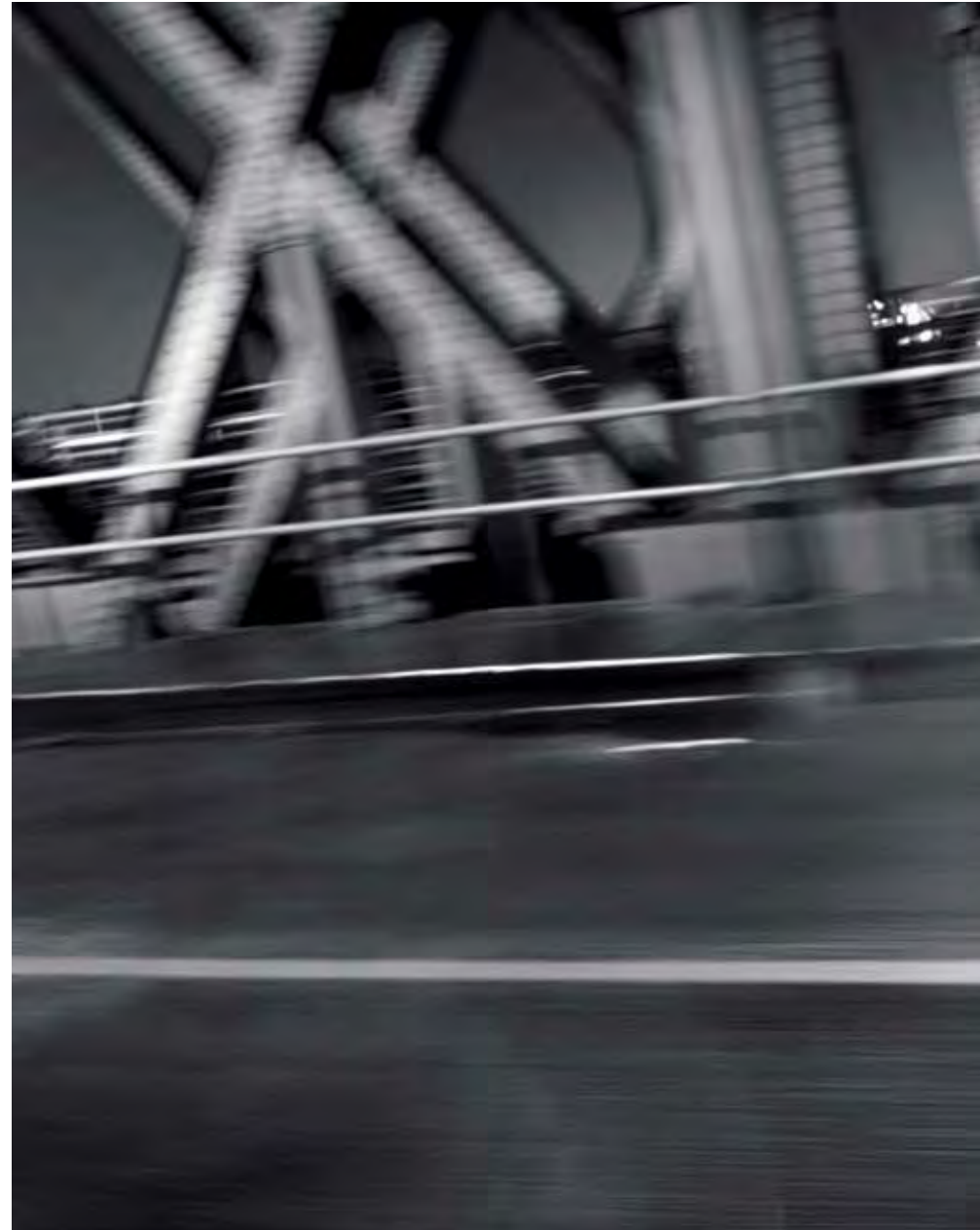



# Engine

## 2.5 TFSI® engine

The five-cylinder engine combines a turbocharger with FSI® direct petrol injection, confirming the status of the Audi RS 3 Sportback as a high-performance sports hatchback. The 2.5-litre TFSI® engine is ultra-compact. Just 49 centimetres in length, and weighing 183 kilograms, it's perfectly suited for transverse installation in the Audi RS 3 Sportback. The crankcase is made of vermicular-graphite cast iron and this high-tech material is both strong and lightweight. Perfectly placed reinforcements enhance the block's loading, while the cylinder head, pistons and connecting rods are also light yet extremely strong.





## Transmission and brakes

The Audi RS 3 Sportback offers a fast-shifting S tronic® transmission for smooth, efficient acceleration and a high-performance braking system to ensure this car stops as well as it goes.

### S tronic®

Driving is all about thinking ahead, which is just what the S tronic® dual-clutch transmission does. It works almost as two separate systems, one engaging the odd-numbered and the other the even-numbered gears. So when you're accelerating in second, it has third gear waiting for you. And once you make the switch, it's already thinking about fourth. With two clutches working together, you can change gears almost instantly while experiencing smooth, uninterrupted power.

### High-performance braking system

We created the high-performance braking system in the Audi RS 3 Sportback with safety and control in mind. It features four-piston brake callipers painted in black with the RS logo on the front axle, as well as ventilated brake discs (370mm in diameter) at the front, drilled and designed using composite materials. All these features help the system to provide excellent braking performance, even when the car is carrying a heavy load.



## quattro®

It's the technology that has given Audi the edge on the rally circuit ever since it was first introduced over 30 years ago – a technology that delivers ultimate control whilst enhancing the sporty characteristics which make the Audi RS 3 Sportback so thrilling to drive. It's called quattro® all-wheel-drive. The principle is simple: in the same way that four brakes ensure better deceleration, four driven wheels deliver better acceleration and road-holding, pushing or pulling the car as needed, for a driving experience that's both dynamic and safe.



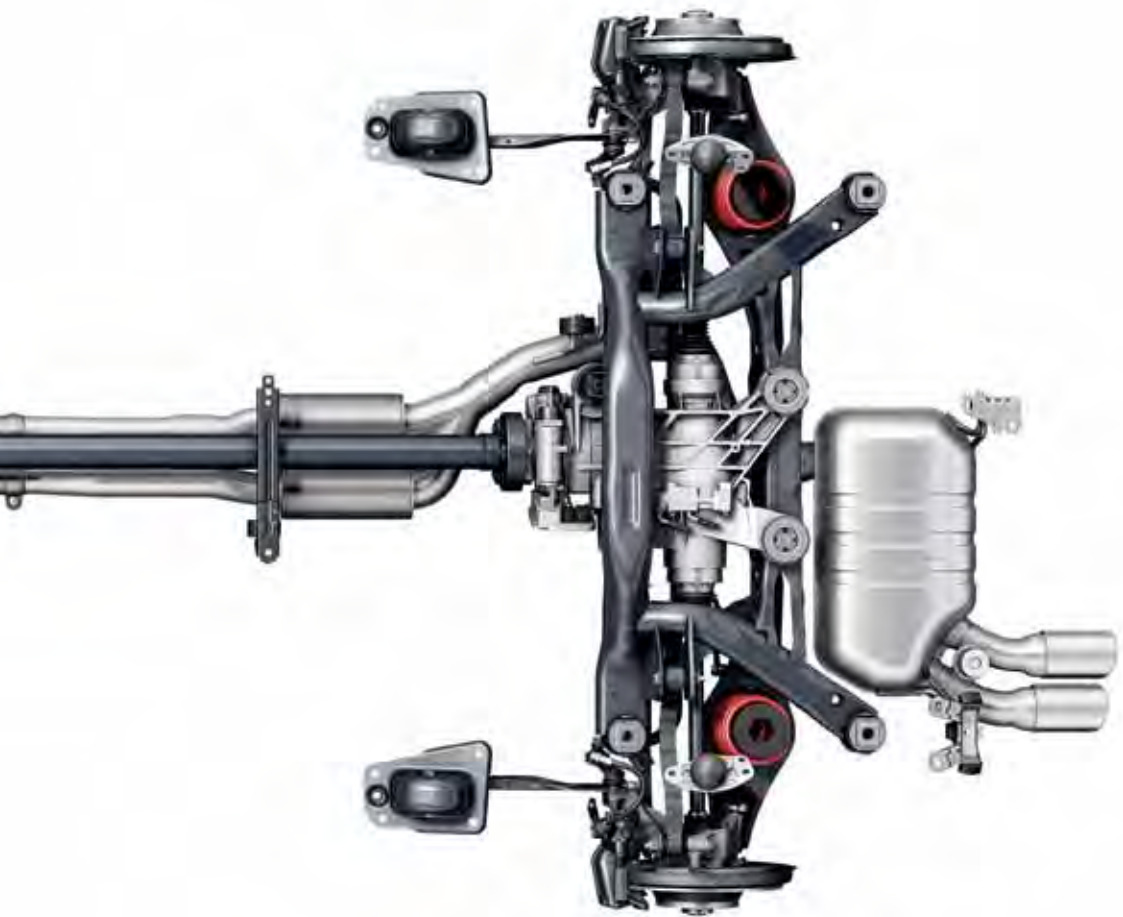

In the Audi RS 3 Sportback, asymmetric dynamic torque distribution continuously distributes drive power between the front and rear axles, depending on weather conditions, road surface and gradient. This leads to greater flexibility and an enhanced, sportier drive.

# Standard model equipment

The RS 3 Sportback has the following items of standard equipment

## Wheels, tyres and suspension

19" x 8J '5-arm Rotor' design, titanium finish alloy wheels with 235/35 tyres front, 225/35 tyres rear

High-performance brake system with brake callipers in high-gloss and RS emblem

RS Sports suspension

Locking wheel bolts

Tyre mobility system

7-speed S tronic® transmission with launch control system

## Seats

Black Fine Nappa leather upholstery with silver contrast stitching and RS 3 embossing

Front Sports seats, manually adjustable (optional RS 3 front bucket seats available)

Heated front seats

Seat belts – 3-point on all seats

Split-folding rear seats (1/3, 2/3 or all)

## Audio and communication

Satellite Navigation system – DVD-based.

Route planning and guidance using voice, pictogram and map. Includes AM/FM tuner with TP memo function. Single front-loading CD player with MP3 compatibility. Controlled using MMI operating logic and 6.5-inch colour monitor with bird's-eye map display. Two integrated MMC/SD card slots for playing MP3 files, European coverage navigation DVD and dynamic route guidance via TMC traffic information

**Audi Music Interface (AMI).** Universal connection for use with stereo audio sources, USB and MP3 devices including Apple iPod generation 4 onwards (iPod, iPod classic, iPod mini, iPod nano, iPod photo, iPod video, iPod touch). Provides intuitive control through the audio system, multi-function steering wheel and Driver's Information System (DIS). It also replicates the iPod display on the audio screen and DIS, including track titles. The interface provides charging function, dependent on device (CD changer can be ordered in lieu of AMI)

Mobile phone preparation – Bluetooth interface

## Safety and security

Audi backguard head restraints for front seats (adjustable)

Driver, front passenger and front side airbag system and Sideguard® airbags

Electronic Stability Programme (ESP), including ABS, EBD, ASR, EDL, with Sport setting

quattro all-wheel-drive

Acoustic parking system rear (only)

First aid kit with warning triangle

ISOFIX child-seat preparation for front passenger seat (with airbag disabling feature) and rear seats

Rear head restraints (adjustable)

Remote central locking

Servotronic speed-dependent power steering

Thatcham Category 1 alarm and immobiliser

Tool kit and car jack



19" x 8J '5-arm Rotor' design, titanium finish alloy wheels

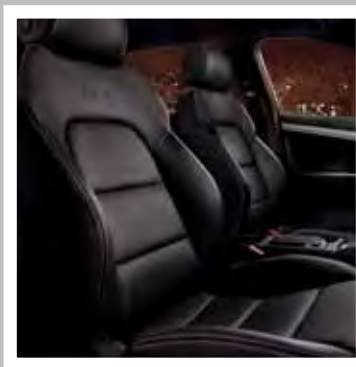

Front Sports seats in black Fine Nappa leather upholstery



Satellite Navigation system – DVD-based



Audi Music Interface

### Exterior equipment

**RS body styling** – RS design front bumper with widened front air intakes, flared front wheel arches, rear diffuser in high-gloss black and RS design rear roof spoiler

**RS 3 badging** front and rear

**Anthracite single-frame grille** with diamond-patterned styling

**Xenon Plus headlights** with automatic headlight adjustment, dynamic range and headlamp washers. Includes LED daytime-running lights

**RS twin elliptical exhausts** on the left-hand side

**Matt-aluminium look door mirror housings**

**Rear fog light**

**Electrically operated and heated door mirrors**

### Interior equipment

**RS Sports 3-spoke multi-function flat-bottomed perforated-leather steering wheel** with matt aluminium-look inserts, RS 3 logo and gear shift paddles

**Sport button on the centre console** – allows the driver to change the RS 3 Sportback's Sport settings by adjusting the throttle response and altering the exhaust note

**Piano Finish black inlays**

**RS instrument dials**

**Door sills with aluminium inlays and RS 3 logo**

**RS 3 logo on the gear knob**

**Perforated leather gear knob gaiter**

**Black cloth headlining**

**Driver's Information System**, monochrome with RS 3 menu. Displays boost pressure, oil temperature and includes a lap timer. Also includes AutoCheck system, radio frequency, two adjustable speed warning thresholds, outside temperature gauge and on-board computer with efficiency programme

**Dual-zone electronic climate control**

**Front centre armrest**

**Illuminated vanity mirrors**

**Aluminium-look pedals**

**Electric front and rear windows**

**Front and rear floor mats**, with silver piping

**Heat-insulating glass**

**Rear window blind** – manual

**Heated rear windscreen**

**Steering wheel** – adjustable for height and reach

**Washer fluid level indicator**

**Ashtray and cigarette lighter** in the centre console



Piano Finish black inlays

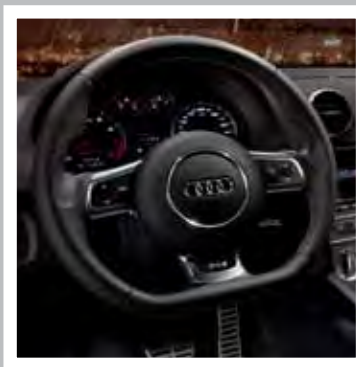

RS Sports 3-spoke multi-function flat-bottomed perforated-leather steering wheel

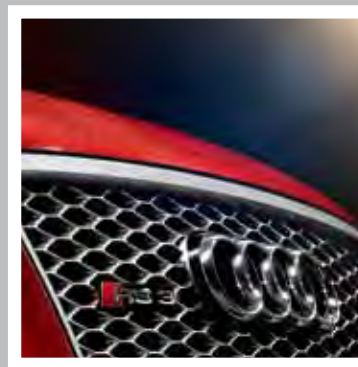

Anthracite single-frame grille with diamond-patterned styling



Xenon Plus headlights with LED daytime-running lights

## RS 3 Sportback

Engine	Power	Transmission	CO <sub>2</sub> g/km	Basic RRP	Total RRP inc VAT	Recommended OTR
2.5 TFSI quattro	340PS	7-speed S tronic	212	£32,254.17	£38,705.00	£39,950.00

**Please note:** The maximum power output figures are quoted in PS (or Pferdestärke, which is the metric equivalent of brake horsepower). To convert to brake horsepower, divide the PS figure by 1.0139.

**Recommended On-The-Road (OTR) retail prices include:** delivery charge, half a tank of fuel, number plates at £590.00 (inc. VAT), Road Fund Licence (see page 37 for details) and first registration fee at £55.00.

RRP – Recommended Retail Price. VAT is calculated at 20% but this may alter to reflect any change in the applicable VAT rate.

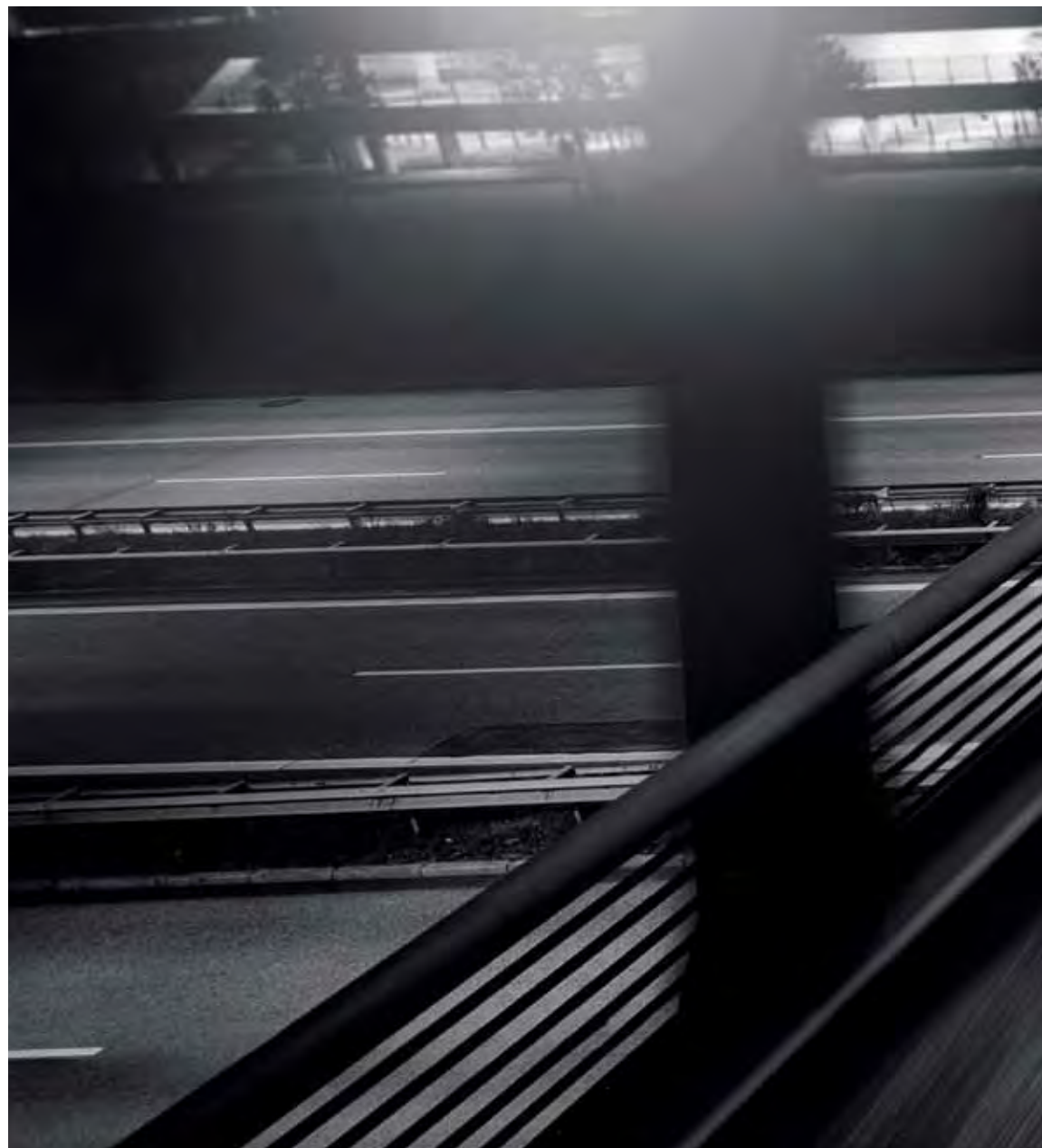



# Paint

You can select the standard Ibis white shown opposite or, for a different look, choose from the range of optional finishes.

## Standard colours



Ibis white – T9

## Optional colours

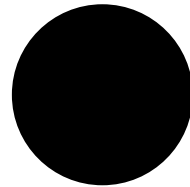

Phantom black, pearl effect – L8

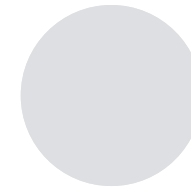

Suzuka grey, metallic – M1

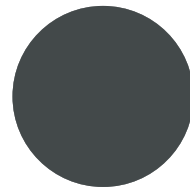

Daytona grey, pearl effect – 6Y

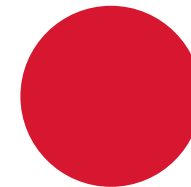

Misano red, pearl effect – N9

Options are subject to availability and may extend delivery.

All the colour swatches on this page are matched as accurately as possible to the actual paint colours used. However, due to print processes, Audi UK cannot guarantee that colours shown are 100% accurate.

Visit your local Audi Centre for a more accurate colour swatch.

RRP – Recommended Retail Price.

VAT is calculated at 20% but this may alter to reflect any change in the applicable VAT rate.

### Optional colours

**Basic RRP**  
£425.00

---

**Total RRP inc VAT**  
£510.00

# Paint

## Audi exclusive

Everyone has a favourite colour. No matter what yours is, Audi exclusive provides a range of unique colours that have been designed to set your car apart. Choose from the swatches here, or specify any other paint colour in the Audi range – whether it's Jet blue from the Audi R8 or Alpine white from the original Audi quattro. The choice is yours.

## Customised

If you have a particular colour in mind, we'll mix the exact metallic or pearl-effect shade you want.\*

\*Custom paint is subject to factory approval, and is available for metallic and pearl-effect water-based paints only. Three-colour process colours and two-tone schemes are not available.

†Visit your local Audi Centre for colour samples.

All the colour swatches on this page are matched as accurately as possible to the actual paint colours used. However, due to print processes, Audi UK cannot guarantee that colours shown are 100% accurate.

Visit your local Audi Centre for a more accurate colour swatch.

RRP – Recommended Retail Price.

VAT is calculated at 20% but this may alter to reflect any change in the applicable VAT rate.

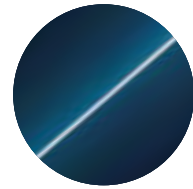

Palace blue, pearl effect

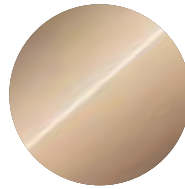

Sand beige, pearl effect

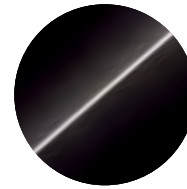

Saddle brown, pearl effect

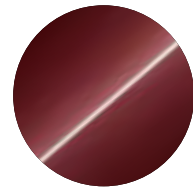

Classic red, pearl effect

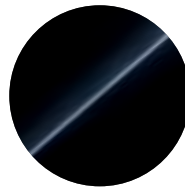

Mamba black, metallic

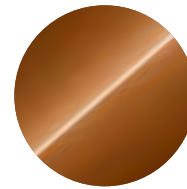

Ipanema brown, metallic



Any colour in the Audi range



100 Audi exclusive colours to choose from†

<b>Audi exclusive</b>
<b>Basic RRP</b> £1,445.83
<b>Total RRP inc VAT</b> £1,735.00



Customised paint

<b>Customised</b>
<b>Basic RRP</b> £2,041.67
<b>Total RRP inc VAT</b> £2,450.00



# Upholstery

## RS 3 Sportback

The RS 3 comes with luxurious Fine Nappa leather, detailed with elegant silver stitching and RS 3 embossing.

Fine Nappa leather

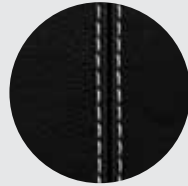

Black with silver stitching and RS 3 embossing

Options are subject to availability and may extend delivery.

- = Not available
- = Available
- S = Standard

All leather upholstery choices include seats, head restraints and front centre armrest (if fitted) in leather.

RRP – Recommended Retail Price.

VAT is calculated at 20% but this may alter to reflect any change in the applicable VAT rate.

RS 3 Sportback	Basic RRP	Total RRP inc VAT
S	No charge	No charge

# Colour and trim guide

## Interior trim colours

Sports seats with RS 3 embossing (Standard)

Bucket seats with RS 3 embossing (PS4)

Order Code	Upholstery	Carpet	Dashboard (upper/lower)	Headlining	Fine Nappa leather
QH	Black with silver stitching	Black	Black/Black	Black	S

Order Code	Upholstery	Carpet	Dashboard (upper/lower)	Headlining	Fine Nappa leather
QH	Black with silver stitching	Black	Black/Black	Black	•

Options are subject to availability and may extend delivery.

- = Not available
- = Available
- S = Standard

# Upholstery

## Audi exclusive

With Audi exclusive, you can specify your seats in Fine Nappa leather or Fine Nappa leather/Alcantara, in an array of different colours shown to the right.

Select just one all-over shade for each seat, or customise each panel in two or more complementary colours from the distinctive Audi exclusive palette. You can even choose the colour of the decorative stitching – to match or contrast with your chosen upholstery – from this varied collection. Whatever combination you decide upon, we think you'll be extremely comfortable with the result.



Chestnut brown



Jet grey



Alabaster white

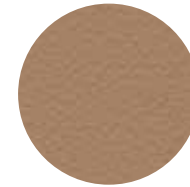

Sand beige

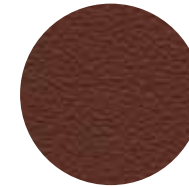

Saddle brown

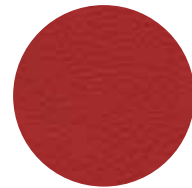

Crimson red



Magnolia white



Havanna brown

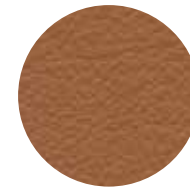

Cognac brown

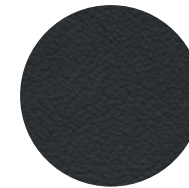

Night blue

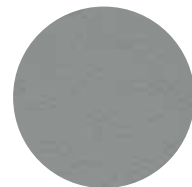

Cloudy grey

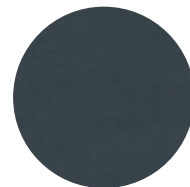

Smoky blue

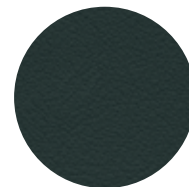

Iceland green



Powder beige

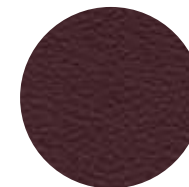

Classic red

## Also available:

**Alcantara colours:** available in all the Audi exclusive colours shown, except for Crimson red, Jet grey and Sand beige. Alcantara equivalents are Chilli red, Amethyst grey and Sesame beige respectively.

Please consult your Audi Centre for examples of Alcantara.

# Upholstery

## Audi exclusive

Order Code		RS 3 Sportback	Basic RRP	Total RRP inc VAT
PYA S3G	<b>Audi exclusive leather package 1 in Fine Nappa leather.</b> Includes leather-covered seat upholstery, front centre armrest, door trim inserts and floor mats with leather piping. Backrest covers and seat add-on parts come in the interior colour*	●	£1,658.33	£1,990.00
PYC S3G	<b>Audi exclusive leather package 1 in Fine Nappa leather/Alcantara.</b> Includes leather-covered seat-side trims, head restraints, front centre armrest and door trim inserts, Alcantara seat-centre sections and floor mats with leather piping. Backrest covers and seat add-on parts come in the interior trim colour*	●	£1,658.33	£1,990.00
YSI S3G	<b>Audi exclusive extended Fine Nappa leather package.</b> Includes knee pads and door handles in exclusive leather*	●	£675.00	£810.00
YTA S3G	<b>Audi exclusive inlays</b> for door trim and gear-shift gate surround	●	£650.00	£780.00
YRB S3G	<b>Audi exclusive leather control elements.</b> Includes steering wheel, handbrake grip and gear-shift in exclusive leather	●	£512.50	£615.00
YRH S3G	<b>Audi exclusive leather steering wheel rim</b>	●	£304.17	£365.00
YTZ S3G	<b>Audi exclusive RS 3 floor mats</b>	●	£375.00	£450.00
YUC S3G	<b>Audi exclusive suede control elements.</b> Includes steering wheel, handbrake grip and gear-shift in suede	●	£512.50	£615.00

Options are subject to availability and may extend delivery.

- = Not available
- = Available
- S = Standard

\*Leather, stitching and piping (where applicable) colours can be specified in a variety of colours from the Audi exclusive range.

RRP – Recommended Retail Price.

VAT is calculated at 20% but this may alter to reflect any change in the applicable VAT rate.



Audi exclusive design package in Black Fine Nappa leather with quilted diamond design and red stitching (please see page 28 for details)

# Inlays

Inlays are the all-important finishing touch that add flair and interest to your car's interior.

Order Code		RS 3 Sportback	Basic RRP	Total RRP inc VAT
<b>5TL</b>	<b>Piano Finish, black</b>	S	No charge	No charge
<b>SMD</b>	<b>Aluminium Race design</b>	●	£83.33	£100.00
<b>YTF</b>	<b>Audi exclusive inlays in body colour</b>	●	£1,125.00	£1,350.00

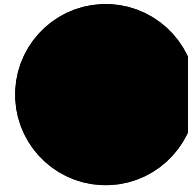

Piano Finish, black – 5TL

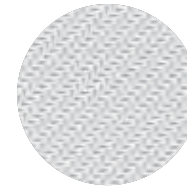

Aluminium Race design – SMD

Options are subject to availability and may extend delivery.

- = Not available
- = Available
- S = Standard

RRP – Recommended Retail Price.

VAT is calculated at 20% but this may alter to reflect any change in the applicable VAT rate.



# Wheels and tyres

Choose a set of specially-selected alloy wheels to enhance the way your car looks.



19" x 8J '5-arm Rotor' design alloy wheels finished in titanium – C55



19" x 8J '5-arm Rotor' design alloy wheels finished in high gloss – C2T



19" x 8J '5-arm Rotor' design alloy wheels finished in black with a red rim – C1I

Options are subject to availability and may extend delivery.

- = Not available
- = Available
- S = Standard

RRP – Recommended Retail Price.

VAT is calculated at 20% but this may alter to reflect any change in the applicable VAT rate.

Order Code		RS 3 Sportback	Basic RRP	Total RRP inc VAT
C55	19" x 8J '5-arm Rotor' design alloy wheels finished in titanium with 235/35 tyres front and 225/35 tyres rear	S	No charge	No charge
F74	19" x 8.5J '5-arm Rotor' design alloy wheels finished in titanium with 255/30 tyres front and 225/35 tyres rear	•	£916.67	£1,100.00
C2T	19" x 8J '5-arm Rotor' design alloy wheels finished in high gloss with 235/35 tyres front and 225/35 tyres rear	•	No charge	No charge
F78	19" x 8.5J '5-arm Rotor' design alloy wheels finished in high gloss with 255/30 tyres front and 225/35 tyres rear	•	£916.67	£1,100.00
C1I	19" x 8J '5-arm Rotor' design alloy wheels finished in black with a red rim with 235/35 tyres front and 225/35 tyres rear	•	£145.83	£175.00
F75	19" x 8.5J '5-arm Rotor' design alloy wheels finished in black with a red rim with 255/30 tyres front and 225/35 tyres rear	•	£1,062.50	£1,275.00





# Audio and communication

Stay in touch using our communication functions, and give each journey its own soundtrack with our advanced audio equipment.

Order Code		RS 3 Sportback	Basic RRP	Total RRP inc VAT
<b>7A2 UFO</b>	<b>CD changer.</b> For six CDs with MP3 CD compatibility. Located in glovebox and controllable via centre console controls or multi-function steering wheel. Will replace Audi Music Interface when ordered	●	£270.83	£325.00
<b>8RY</b>	<b>BOSE® premium sound system.</b> 8 high-performance loudspeakers, 6-channel amplifier, total output of 195 Watts with specially tuned acoustics	●	£375.00	£450.00
<b>9ZU</b>	<b>Mobile telephone preparation – Low with Bluetooth and voice control.</b> Provides handsfree connection via Bluetooth using mobile phone aerial. Alternatively, it can use a cradle with charging facility for optimal reception via external aerial. Located in front centre armrest. Cradle available at extra cost – please contact your Audi Centre for phone compatibility	●	£120.83	£145.00

Options are subject to availability and may extend delivery.

- = Not available
- = Available
- S = Standard

RRP – Recommended Retail Price.

VAT is calculated at 20% but this may alter to reflect any change in the applicable VAT rate.



BOSE® premium sound system



Mobile telephone preparation – Low with Bluetooth and voice control



CD changer

# Interior equipment

Specify every detail of your car's interior with this range of options.

Options are subject to availability and may extend delivery.

\*HomeLink® is a registered trademark of Johnson Controls. For information on compatibility, visit [www.homelink.com](http://www.homelink.com)

- = Not available  
• = Available  
S = Standard

RRP - Recommended Retail Price.

VAT is calculated at 20% but this may alter to reflect any change in the applicable VAT rate.

Order Code		RS 3 Sportback	Basic RRP	Total RRP inc VAT
8T2	<b>Cruise control.</b> For holding any speed above 25mph	•	£183.33	£220.00
PZA	<b>Through-load facility.</b> Includes removable ski bag for transporting long objects and rear centre armrest with cup holder	•	£150.00	£180.00
PKB	<b>Luggage package.</b> Comprising combi-net for fixing into luggage compartment and 12V socket in boot	•	£45.83	£55.00
QE1	<b>Storage package.</b> Comprising storage nets on front-seat backrests, storage compartment under driver's seat, map compartment in glovebox, net on side of centre console and bag hooks in luggage compartment. Under seat storage deleted when ordered with electric seats. Storage package cannot be ordered in conjunction with bucket seats (PS4)	•	£75.00	£90.00
6SJ	<b>Reversible load floor mat.</b> Luggage compartment floor mat can be reversed to provide a rubber mat which extends to protect rear bumper	•	£41.67	£50.00
QQ4	<b>Interior light package.</b> Includes illuminated door openers, storage compartment, footwell lighting and active door reflectors	•	£75.00	£90.00
3Y3	<b>Rear window and side window blinds - manual</b>	•	£70.83	£85.00
VC1	<b>Garage door opener (HomeLink®)*</b> Programmable radio-operated remote control for up to 3 compatible doors/gates. Control buttons integrated in the roof module at the front	•	£150.00	£180.00
9JA	<b>Non-smoking package.</b> Replaces ashtray and cigarette lighter with 12V socket and centre storage compartment	•	No charge	No charge



Cruise control



Luggage package



Through-load facility

# Seats

Choose from a variety of different seat options so you can maintain the right driving posture at all times.

Options are subject to availability and may extend delivery.

- = Not available  
 ● = Available  
 S = Standard

RRP – Recommended Retail Price.

VAT is calculated at 20% but this may alter to reflect any change in the applicable VAT rate.

Order Code		RS 3 Sportback	Basic RRP	Total RRP inc VAT
3PE	<b>Electric driver's seat.</b> Includes adjustment for height, forwards and backwards position and backrest angle. Only in combination with through-load system and electric lumbar support	●	£262.50	£315.00
3L5	<b>Electric front seats.</b> Includes adjustment for height, forwards and backwards position and backrest angle. Only in combination with through-load system and electric lumbar support	●	£458.33	£550.00
7P1	<b>Electric lumbar support.</b> For front seats with horizontal and vertical adjustment	●	£162.50	£195.00
4A4	<b>Heated front and rear seats.</b> Individually controlled variable temperature adjustment	●	£162.50	£195.00
PS4	<b>Bucket seats (front) in black Fine Nappa leather with RS 3 embossing with manual adjustment.</b> Includes through-load facility without ski-bag. Only in combination with first-aid kit. Not available in combination with electric lumbar support or storage package. Please note that this option deletes front side airbags and front seat ISOFIX preparation for front passenger seat	●	£1,704.17	£2,045.00
PYO S3G YRB	<b>Audi Exclusive Design package in Black Fine Nappa leather with quilted diamond design and red stitching.</b> Also includes exclusive leather control elements (YRB). Only in combination with bucket seats (PS4)	●	£2,412.50	£2,895.00
PYI S3G	<b>Audi Exclusive Design package Fine Nappa leather with quilted diamond design.</b> In a choice of leather and stitching colours from the Audi range. Only in combination with bucket seats (PS4)	●	£2,412.50	£2,895.00
YSZ S3G	<b>Audi exclusive backrest cover painted in body colour.</b> Only in combination with bucket seats (PS4)	●	£1,791.67	£2,150.00



Front Sports seats in black Fine Nappa leather upholstery (Standard)



Bucket seats (front) in black Fine Nappa leather with RS 3 embossing

# Exterior equipment

Make sure your RS 3 Sportback looks exactly as you want it to by selecting some of our striking exterior options.

Order Code		RS 3 Sportback	Basic RRP	Total RRP inc VAT
3S2	<b>Black roof rails.</b> Not available with matt aluminium styling package	●	£191.67	£230.00
VW1	<b>Privacy glass.</b> Dark tinted glass from B-pillar backwards	●	£275.00	£330.00
PQA	<b>Black styling package.</b> Front radiator grille, grille frame and tailpipes finished in highly-polished black. Top edge of rear diffuser finished in black	●	£329.17	£395.00
4ZL	<b>Matt aluminium styling package.</b> Includes a matt aluminium finish to the following elements: front spoiler lip, front diffuser and front air intake edges, door handle trim, sides of the rear roof spoiler and the top edge of the rear diffuser. Not available with matt aluminium roof rails	●	£566.67	£680.00
2Z0	<b>Deletion of model and technology designation at rear</b>	●	No charge	No charge

Options are subject to availability and may extend delivery.

- = Not available
- = Available
- S = Standard

RRP – Recommended Retail Price.

VAT is calculated at 20% but this may alter to reflect any change in the applicable VAT rate.



Matt aluminium styling package

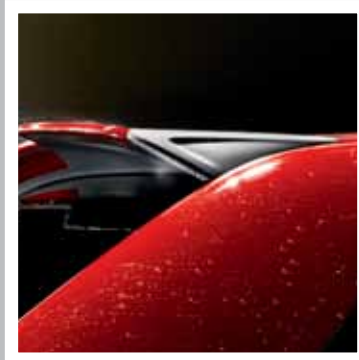

Matt aluminium styling package

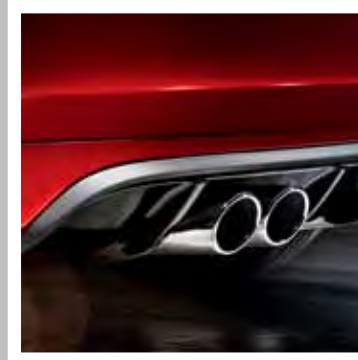

Matt aluminium styling package

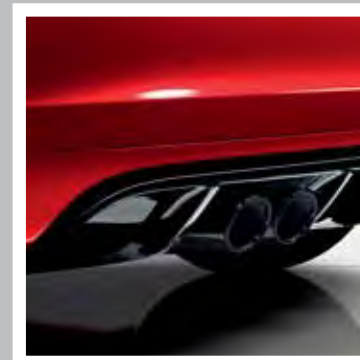

Black styling package

# Safety and security

Intelligent technology designed to give you better all-round awareness and safety on the road.

Order Code		RS 3 Sportback	Basic RRP	Total RRP inc VAT
4X4	<b>Rear side airbags.</b> Situated in side of rear seats. Only in combination with through-load facility	●	£254.17	£305.00
PU7/6XJ	<b>Light and rain sensor pack.</b> Includes auto-dimming rear-view mirror and door mirrors, automatic headlight activation, automatic windscreen wipers, coming home/leaving home function and sun band for windscreen	●	£275.00	£330.00
6XE	<b>Door mirrors – electrically adjustable, folding and heated</b>	●	£104.17	£125.00
8N7	<b>High-beam assist.</b> Automatically adjusts headlights from high-beam to dipped-beam when another vehicle is approaching. Only in combination with light and rain sensor pack	●	£83.33	£100.00
8Q5	<b>Adaptive headlights.</b> Swivelling headlights for improved illumination of a winding road	●	£245.83	£295.00

Options are subject to availability and may extend delivery.

- = Not available
- = Available
- S = Standard

RRP – Recommended Retail Price.

VAT is calculated at 20% but this may alter to reflect any change in the applicable VAT rate.





# Audi Complete

Audi Complete is simply a way to look after the servicing and maintenance costs for your Audi in a single package. You pay a one-off or monthly fee and we'll cover all your servicing, maintenance and tyres for the next three years including your first MOT and a full 5-year warranty. It means you only have to pay for fuel, insurance and your Road Fund Licence. So you can be reassured that your car will be maintained by trained Audi Technicians, using genuine Audi parts.

\*Retail customers only. Pricing based on 3 years/30,000 miles (whichever occurs sooner). All pricing is a 'starting from' price for the Audi RS 3 model range and is therefore subject to change and mileage/model dependent.

## Warranty

Options are subject to availability and may extend delivery.

- = Not available  
• = Available  
S = Standard

\*\*Only available prior to registration of your Audi RS 3. Please speak to your Audi Centre for full details.

RRP - Recommended Retail Price.

VAT is calculated at 20% but this may alter to reflect any change in the applicable VAT rate.

Order Code			RS 3 Sportback	Basic RRP	Total RRP inc VAT
AC1	<b>Audi Complete – Service, Maintenance and 5-year warranty.</b> Comprehensive care for your Audi covering all your servicing and maintenance for 3 years, as well as your first MOT and a full 5-year/90,000 mile warranty. Visit your local Audi Centre for further information or <a href="http://audi.co.uk/audicomplete">audi.co.uk/audicomplete</a> for full details including terms and conditions	Monthly Direct Debit	●	£30.00	£36.00*
AC2	<b>Audi Complete – Service, Maintenance, Tyres and 5-year warranty.</b> Comprehensive care for your Audi covering all your servicing, maintenance and tyres for 3 years, as well as your first MOT and a full 5-year/90,000 mile warranty. Visit your local Audi Centre for further information or <a href="http://audi.co.uk/audicomplete">audi.co.uk/audicomplete</a> for full details including terms and conditions	Monthly Direct Debit	●	£53.33	£64.00*

Order Code			RS 3 Sportback	Basic RRP	Total RRP inc VAT
EA6	<b>Audi Warranty,</b> covering you for up to 4 years or 75,000 miles, whichever comes soonest. Cover includes a two-year unlimited mileage warranty, and up to 75,000 miles in the third and fourth years. Transferable between owners**		●	£204.17	£245.00
EA9	<b>Audi Warranty,</b> covering you for up to 5 years or 90,000 miles, whichever comes soonest. Cover includes a two-year unlimited mileage warranty, and up to 90,000 miles in the third, fourth and fifth years. Transferable between owners**		●	£454.17	£545.00

# Merchandise

From the enthusiasts' motorsport collection to the sophisticated Audi collection, there's a wide variety of adults' and children's clothing, lifestyle accessories and collectables, all of which bear the Audi name.

Please speak to a member of our team at your local Audi Centre to see the full Audi collection and to place an order. A selection of Audi merchandise is also available to buy from [audi.co.uk/merchandise](http://audi.co.uk/merchandise).



Audi kids



Bags and leather goods



Clothing



Motorsport



Sport and travel



Model cars



# Accessories

Choosing an Audi isn't just a matter of deciding on the model you want; it's about creating a car that suits your needs perfectly. And that's why we've developed a whole range of accessories to enhance your RS 3 Sportback, enabling you to customise it down to the last detail. Like your Audi, all these accessories are developed to the highest possible standards. And they're all available exclusively from Audi. To find out more, just visit [audi.co.uk/accessories](http://audi.co.uk/accessories) or contact your local Audi Centre.

## Warranty

All of the accessories available on the RS 3 Sportback are covered by a three-year warranty\* if they are ordered and included in the purchase price of the car at date of delivery. Any accessories ordered and installed after delivery include a two-year warranty.\*

\*Excluding Road Angel products.

Audi Accessories warranty terms and conditions can be found at [audi.co.uk](http://audi.co.uk)



Sport and design

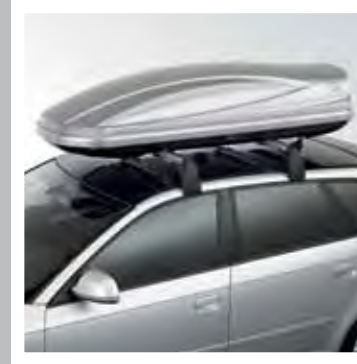

Transport and touring

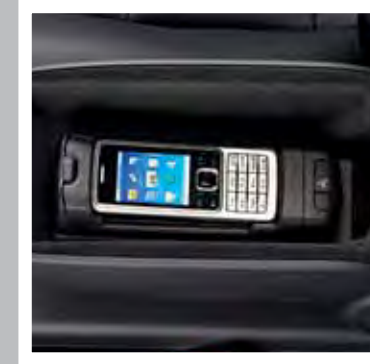

Entertainment and communication



Comfort and protection

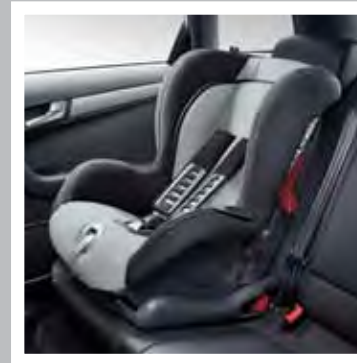

Family



Safety and security

# RS 3 Sportback technical data

Engine	2.5 TFSI quattro
Transmission	7-speed S tronic
Cylinder	5-cylinder
Displacement, cubic cm (valves per cylinder)	2480 (4)
Max. power <sup>1</sup> , PS at rpm	340/5400-6500
Max. torque, Nm at rpm	450/1600-5300
0-62mph acceleration, seconds	4.6
Top speed <sup>2</sup> , mph	155*
CO <sub>2</sub> emissions <sup>3</sup> , g/km	212
Benefit in kind (BIK)%	33%
Fuel consumption <sup>3</sup> , mpg (l/100km) Urban	21.6 (13.1)
Fuel consumption <sup>3</sup> , mpg (l/100km) Extra Urban	41.5 (6.8)
Fuel consumption <sup>3</sup> , mpg (l/100km) Combined	31.0 (9.1)
ABI insurance group 1-50 <sup>4</sup>	42 E
Unladen weight <sup>4</sup> , kg	1575
Gross weight limit, kg	2135
Roof load limit/nose weight, kg	75
Luggage compartment capacity, rear seats upright, litres	302
Luggage compartment capacity, rear seats folded, litres	1032
Fuel tank capacity approx, litres	60

\*Electronically limited.

<sup>4</sup>Highest insurance group rating shown. Please visit [www.thatcham.org/abigrouprating](http://www.thatcham.org/abigrouprating) for details.

**Please note:** The maximum power output figures are quoted in PS (or Pferdestärke, which is the metric equivalent of brake horsepower). To convert to brake horsepower, divide the PS figure by 1.0139.

<sup>1</sup>The given value was obtained in accordance with the specified measurement procedure (the respective current version of the Directive 80/1269/EEC).

<sup>2</sup>Top speed is achieved in top gear.

<sup>3</sup>Fuel consumption and CO<sub>2</sub> emissions figures are obtained under standardised test conditions (Directive 93/116/EEC) using a representative model. This allows direct comparison between different models from different manufacturers, but may not represent the actual fuel consumption achieved in 'real world' driving conditions. More information is available at [www.vca.gov.uk](http://www.vca.gov.uk).

<sup>4</sup>Vehicle's unladen weight without driver (calculated in accordance with the current version of Directive 80/1268/EEC). The fitting of additional equipment may increase the vehicle's unladen weight and drag coefficient, whereupon the potential carrying capacity and top speed will be correspondingly reduced.



# RS 3 Sportback dimensions

The technical drawings opposite show the exact dimensions of the Audi RS 3 Sportback, so you can check everything – from whether the car will fit in your garage to whether your luggage will fit in the boot.

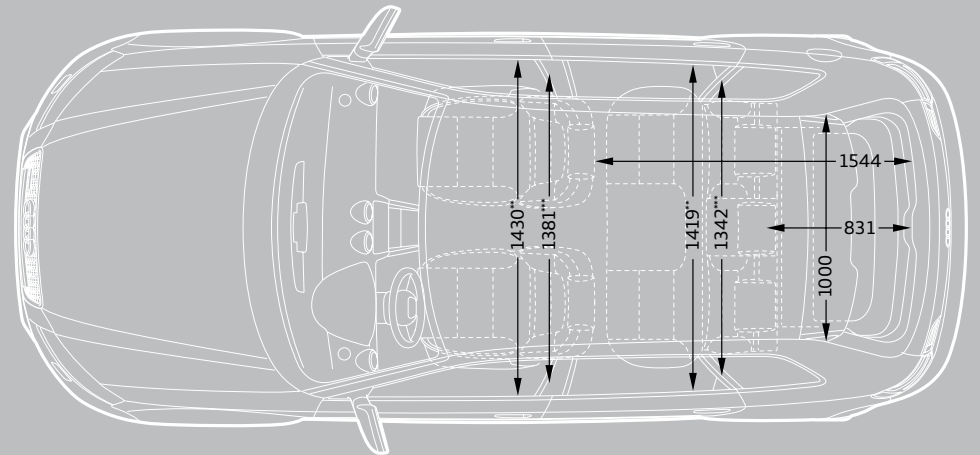
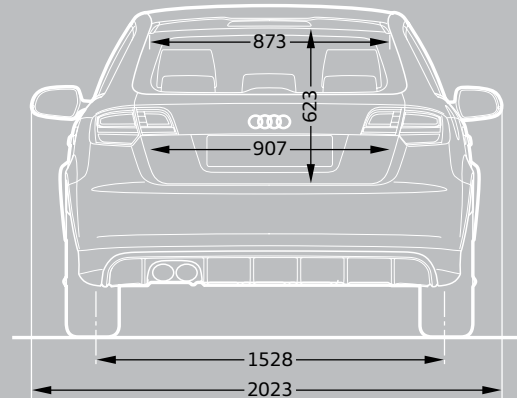
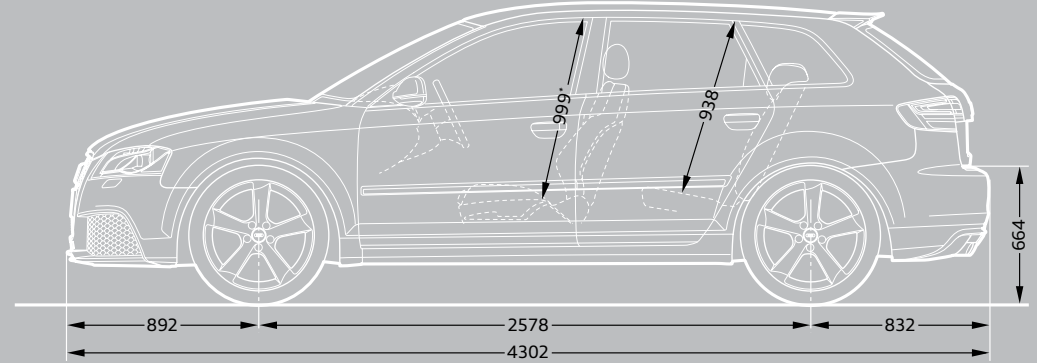
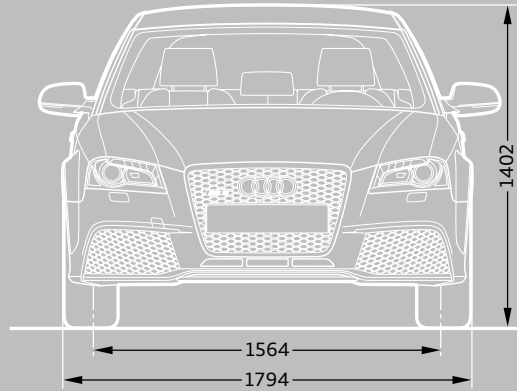

Dimensions were measured with vehicle at unladen weight.

Turning circle approx 10.7m.

Dimensions in millimetres.

\*Maximum headroom.

\*\*Elbow room width.

\*\*\*Shoulder room width.

# Additional information

## CO<sub>2</sub> data and information

### CO<sub>2</sub> emissions-based Vehicle Excise Duty

Vehicle Excise Duty (Road Fund Licence) is based upon the amount of Carbon Dioxide (CO<sub>2</sub>) a vehicle emits, measured in grams per kilometre (g/km). First year VED rates apply to the first year of ownership. Annual VED rates apply thereafter. The DVLA has created thirteen categories:

Petrol and Diesel engines	First year	Annual rate (second year onwards)
A – up to 100g/km	£0.00	£0.00
B – 101 to 110g/km	£0.00	£20.00
C – 111 to 120g/km	£0.00	£30.00
D – 121 to 130g/km	£0.00	£100.00
E – 131 to 140g/km	£120.00	£120.00
F – 141 to 150g/km	£135.00	£135.00
G – 151 to 165g/km	£170.00	£170.00
H – 166 to 175g/km	£275.00	£195.00
I – 176 to 185g/km	£325.00	£215.00
J – 186 to 200g/km	£460.00	£250.00
K – 201 to 225g/km	£600.00	£270.00
L – 226 to 255g/km	£815.00	£460.00
M – over 255g/km	£1,030.00	£475.00

Vehicle Excise Duty (VED) rates correct at time of going to print, but these may alter to reflect any change in the applicable VED rate

### Servicing tailored to your needs

Regular servicing is key to safeguarding your Audi's performance and a full Audi service history could help you preserve the future re-sale value. To make servicing easy, the Audi Service Schedules have been designed to work with your individual driving style and vehicle.

There are two schedules available and your Audi Centre will advise which schedule is most suited to your needs. The conventional fixed Audi Inspection Service schedule has fixed intervals for the Oil-change and Inspection Service that are based on time and distance, whichever comes first.

With the Audi LongLife Service schedule, sensors take account of driving style and conditions in which the vehicle is used to indicate when the Oil-change Service is required. Oil-change Service intervals are therefore variable and are conveniently indicated via the on-board service interval display.

### Audi Complete

When selecting the option of Audi Complete your vehicle should be placed on the following service schedules dependent on your mileage per annum:

- ▶ Under 10,000 miles per annum – Fixed Inspection Service Schedule
- ▶ Over 10,000 miles per annum – LongLife Service Schedule

Fixed Inspection Service Schedule		Variable LongLife Service Schedule	
	Vehicle usage:		Vehicle usage:
Mileage	Less than 10,000 miles per annum	Mileage	More than 10,000 miles per annum
Type of journey	Mainly city/town centre driving. Short journeys	Type of journey	Motorway and main road driving. Mainly longer distance journeys. Constant speeds
Conditions	Frequent cold starts. High engine loading – e.g. frequent hill climbs, vehicle fully loaded, towing	Conditions	Normal engine loading – e.g. with little or no towing, with little or no hill climbs. Normal vehicle loading
Driving style	Uneconomical – e.g. heavy acceleration, heavy braking, constant changes in speed, constant use of high revs, 'sporty' driving	Driving style	Moderate acceleration, moderate braking, engine revs mainly below 3,000
	Service Intervals:		Service Intervals:
Oil-change Service	Fixed to every 9,000* miles/1 year	Oil-change Service	Variable to a maximum of every 19,000* miles/2 years
Inspection Service	Fixed to every 19,000* miles/2 years	Inspection Service	Fixed to every 19,000* miles/2 years

\*As indicated by the service interval display. Mileages are approximate as the Service Indicator system uses kilometres as its distance measurement.

# Additional information

## Welcome to Audi

By placing an order for your Audi, you're choosing to get behind the wheel of one of the most sophisticated cars on the road. And because we believe the service we offer should be just as advanced, we wanted to let you know exactly what you can expect from us, now and in the future.

We've agreed a set of standards with all our Centres, which governs the way we do business with you. It outlines the kind of service we promise to deliver for every customer, right down to filling each new Audi we sell with half a tank of fuel.

So whether you're interested in the date your car will arrive in the UK or the way we'll dispose of non-biodegradable materials after we service your Audi, you can have total confidence in us.

## Audi Promise

### Audi Centres

We guarantee that all of our Centres will be open as follows:

Sales: Monday to Friday 9am–6pm  
Saturday 9am–5pm

Service: Monday to Friday 8am–6pm  
Saturday 8.30am–1pm

Sunday opening is at local discretion.

### New car delivery

Once we've confirmed a delivery date for your car, we'll keep you informed of progress. Subject to reasonable notice, we'll then deliver it to a place of your choice, whether that's your home or place of work. In the unlikely event of a delay, we'll provide a courtesy car to minimise inconvenience and keep you mobile.

### The experts in Vorsprung durch Technik

Would you entrust your Audi to anyone who hasn't been regularly trained to Audi standards? Our network of Audi Approved Master Technicians have undergone an impressive 100,000 hours of training over a 10-year programme to ensure they have the latest technical expertise for maintaining and servicing your Audi. All of our Service Advisors undergo a specialist induction and training to ensure they are Audi professionals and able to talk to you about any issues you may have with your Audi vehicle. What's more, we have so much expertise and experience in looking after Audi vehicles that we are able to make a note of your mileage and the state of your vehicle as and when we see it and predict when certain key events may occur. As part of our commitment to you, we will notify you in plenty of time so you can make an appointment with us.

### Your convenience comes first

At Audi you can choose from a range of convenient services that suit your needs. Why not book a 'service while you wait' appointment\* and enjoy our complimentary refreshments while your car is with us? Or, if you need to be mobile, take advantage of one of our courtesy cars which we can even collect and deliver to you.\* We guarantee we can service your Audi within 5 days without a courtesy car, or within 10 days if you need transport. We will also ensure your car is returned to you with a full valet.

### Audi Genuine Parts

Would you put a part into your Audi that wasn't the same quality as the factory fitted original? You can rest assured that only Audi Genuine Parts will be used on your vehicle. What's more, Audi parts and labour come with a 2-year guarantee.\*\* We stock a wide variety of parts, so we are well covered. However, if we don't have a part in stock at our Centre we have the back-up of parts at other Audi Centres, at our national warehouse and our factory and can usually source the relevant part very quickly.

### We don't like surprises either

We believe strongly in transparency and there will be no hidden costs. For added peace of mind, we will give you a quotation over the phone for the work you have requested and email you the price confirmation. We'll consult you if any additional work on your car is needed when it is with us. We won't carry out any extra work without asking your permission first.

### The Audi Stamp

Regular servicing is key to safeguarding your Audi's performance and a full Audi service history could help you preserve the future re-sale value of your car. Only the Audi Stamp will prove your approved Audi service history.

### Getting better every time

We continually gather feedback from our Audi Trained Technicians, as well as our customers, to ensure our vehicles are running as they should. Whenever we see an Audi for a service, we connect it directly to our headquarters in Ingolstadt which enables us to check your car's software and make sure it's as up-to-date as possible. If the factory has released a software upgrade for your model, it can be applied immediately – improving anything from your car's efficiency to the precision of its parking system.

### Environmental commitment

We promise to dispose of all non-biodegradable materials from your vehicle in a responsible manner.

\*Subject to availability.

\*\*Excludes wear and tear.

# Pricing information

## Pricing

Prices and specifications given are correct at the time of printing. Always check details with your Audi Centre, as Audi policies are continually developing. We reserve the right to change prices or specifications at any time.

All prices are subject to VAT, currently charged at 20% but this may alter to reflect any change in the applicable VAT rate.

Delivery charges and number plates are not included in the vehicle price.

Delivery charge	£471.66
Number plate	£20.00
VAT	£98.34
Total	£590.00

## Audi Roadside Assistance

Your new car comes complete with 3 years' complimentary roadside assistance and recovery across the UK provided by RAC Motoring Services. Also included is roadside assistance throughout Europe, managed by RAC Motoring Services.

For further information and terms and conditions please visit [audi.co.uk](http://audi.co.uk)

## Audi Customer Care

Every new Audi benefits from the comprehensive Audi Customer Care Package, which comprises:

- ▶ A 3-year Audi warranty, which covers you for unlimited mileage in the first 2 years of ownership, with a full mechanical and electrical warranty which covers you for up to 60,000 miles in the 3rd year

- ▶ A 3-year paint warranty
- ▶ A 12-year anti-corrosion warranty
- ▶ 3 years' UK roadside assistance and recovery

You also have the option when ordering your new car of choosing a four-year or five-year Audi warranty. Speak to a member of the sales team for more information.

## Audi Tax-Free Sales

If you are entitled to purchase a vehicle free of VAT, normally through Military or Diplomatic privilege, please contact your local Audi Centre for full details.

Should you have any difficulty obtaining the information you require, please call Freephone 0800 585878.

## Audi Finance

Audi Finance specialise in providing funding solutions for Audi drivers. Whether your Audi is for private or business use, there are a range of funding options to choose from.

Below is the full range of finance products.

- ▶ Solutions – a Personal Contract Plan
- ▶ Hire purchase
- ▶ Lease purchase
- ▶ Finance lease
- ▶ Contract hire

With all products, you can choose a fixed-cost maintenance plan designed to help you budget accurately.

No matter what Audi model you choose, your local Audi Centre can provide you with a personalised quote which could fit your budget and motoring needs.

Audi Finance is a trading name of Volkswagen Financial Services (UK) Limited. An offer of finance depends on certain conditions. Available to people over 18 in the UK only.

## Audi Insurance

We want you to start enjoying your new car from day one and thanks to Audi Insurance complimentary seven day cover, you can. Call free on 0800 316 7893 (lines are open Monday to Friday 8am - 9pm, and Saturday 9am - 5pm), provide a few details and a cover note will be sent to your Audi Centre. They will then tax your car and you can drive it away.

Audi Insurance is a trading name of Volkswagen Insurance Service (Great Britain) Limited, an appointed representative of Volkswagen Financial Services (UK) Limited, Brunswick Court, Yeomans Drive, Blakelands, Milton Keynes MK14 5LR. Registered in England number 2835230. Audi Insurance is sold, underwritten and administered by Allianz Insurance plc registered in England number 84638. Registered office 57 Ladymead, Guildford, Surrey GU1 1DB. Volkswagen Financial Services (UK) Limited and Allianz Insurance plc are authorised and regulated by the Financial Services Authority. Volkswagen Financial Services (UK) Limited and Allianz Insurance plc are not part of the same corporate group.

**Audi UK**

Customer Services  
Selectapost 29  
Sheffield  
S97 3FG  
0800 699888  
audi.co.uk

Specifications and prices subject  
to change without notice.

© Audi (UK)

Printed in the UK  
Edition 3.1 05/12  
2013 model year

Images are for illustrative purposes only.

