



The Audi A1 range

Pricing and Specification Guide
Valid from August 2013

Personalising your Audi A1

This guide has been designed to help you tailor and price your Audi A1 quickly and logically. At the back, you will find information on CO2 emissions-based taxation and the other services offered by Audi, including Finance and Insurance. You can also configure your Audi A1 online at audi.co.uk.

Audi Vision

To accompany this printed guide, we've created Audi Vision – an intuitive app that lets you find out even more about the Audi A1. Compatible with Apple and Android phones and tablets, Audi Vision gives you exclusive access to images, information and video content – all of which is designed to help you explore and understand the options available with this model.

You'll see the Audi Vision logo printed next to the page number on pages throughout this guide and wherever you do, you'll be able to view additional content on that page.



The Audi A1

Engines	12
Transmission	13
Efficiency	14
Technology	16

Model details and prices

SE model equipment	20
Sport model equipment	22
S line model equipment	24
A1 Editions: S line Style Edition	26
A1 Editions: Black Edition	28
Model prices	30

Audi exclusive

Colour and upholstery

Paint	34
Roof contrast line	38
Contrast roof	40
Upholstery	42
Media Style package	50
Colour and trim guide	52
Interior styling	54

Options

Wheels, tyres and suspension	60
Packages	64
Audio and communication	66
Interior equipment	68
Exterior equipment	70
Safety and security	72
Steering wheels	74

Looking after your Audi

Audi Complete and Service Plan	76
Warranty	79
Accessories	80
Merchandise	81
Audi Difference	82

Technical details

Technical data	83
Dimensions	86
Pricing and Additional information	88





Vorsprung durch Technik

Three words that express the very essence of Audi. Vorsprung durch Technik isn't a slogan. It's our way of seeing the world. It is the driving force behind our history of innovation that continues into the 21st century. Indeed, many technologies that Audi pioneered remain in our cars today. Some are milestones in the history of the motorcar.

From our beginnings in 1899, to the Auto Union team's Grand Prix successes in the 1930s and our more recent wins at Le Mans, we have always been at the forefront of the motor industry.

Vorsprung durch Technik makes us who we are. To see more of its influence, just read on.





The Audi A1 – a big idea condensed

Sometimes it's the smallest things that contain the biggest ideas: the humble paper clip, the tungsten filament, the pocket army knife. The Audi A1 is no exception. This car is a distillation of all the great technologies which came before it – many of which appear in the flagship A8.

Featuring TDI® and FSI® engines born and bred on the racetrack and cutting edge technologies such as Start-Stop and S tronic®, this is amongst our most efficient cars.









A1 interior story

We've introduced a number of finishing touches to the Audi A1 interior to make your driving experience both comfortable and unique. You'll find an impressive attention to detail in everything from the 6.5" manually retractable TFT colour display screen to the optional luxurious leather seating, which means that every journey you make will be a personal one.

Engines

Petrol

FSI® direct-injection technology is a unique Audi innovation that was originally developed for the Le Mans 24-hour endurance race to deliver more power and torque, as well as enhanced fuel efficiency. Precisely the right amount of fuel and air are injected into the combustion chambers, enabling the engine to ‘breathe’ more easily. It results in reduced heat loss and increased output, with around a 15% reduction in fuel consumption and significantly lower exhaust emissions. We’ve also developed TFSI® with turbocharging – giving cars an extra injection of power.

Diesel

We introduced TDI® to the roads in 1989, and since then, we’ve continuously refined it, including developing common-rail technology. Under this system, a series of piezo injectors use electrical charge to precisely control the amount of fuel injected into the engine. As well as reducing noise, this allows combustion to happen at a lower temperature, with less oxygen, which lowers emissions.





Transmission

S tronic®

Driving is all about thinking ahead, which is just what the S tronic® dual-clutch transmission does. It works almost as two separate systems, one engaging the odd-numbered and the other the even-numbered gears. So when you're accelerating in second, it has third gear waiting for you. And once you make the switch, it's already thinking about fourth. With two clutches working together, you can change gears almost instantly while experiencing smooth, uninterrupted power. S tronic® is available on 1.4 TFSI models.

Efficiency

At Audi, doing less is something we're trying to do more of. We're working to use less fuel, release less CO₂ and waste less energy. It's why we've incorporated a number of more efficient technologies into the Audi A1.

TDI® and FSI®

Inside the engine of the A1, you'll find the same advanced fuel-injection technology that's driven us to win after win at Le Mans. With TDI® and FSI®, fuel is injected directly into the engine's chambers so that combustion is timed right down to the millisecond. As a result, waste is minimised and you get the most from every last drop of fuel.

Automatic Start-Stop function

In traffic, your car still uses fuel and releases CO₂, even when it's stationary. The automatic Start-Stop function is a smart new technology that counteracts this problem by being able to switch off the engine when your A1 comes to a standstill. As soon as you touch the clutch (or brake pedal on S tronic® models), the car restarts. By only using the engine when it's needed, it helps to save fuel and reduce emissions – especially in heavy urban traffic.





Audi cylinder-on-demand

Dynamic performance does not necessarily equate to higher consumption – as the 1.4 TFSI (140PS) cylinder-on-demand engine proves. Using advanced cylinder-on-demand technology to automatically shut down two of the four cylinders when the engine is operating at lower loads, particularly when cruising on the motorway or in city traffic, you benefit from the efficiency and low emissions of a comparable diesel engine. Out on the open road meanwhile, the instantaneous power of TFSI®, combining turbocharging with petrol direct injection, is ready and waiting.

Recuperation

When a vehicle brakes, the discs convert the kinetic energy into thermal energy, which is wasted as it cannot be used. With a recuperation system, like the one in the Audi A1, the kinetic energy is converted into useful electrical energy. The way it works is simple. While the car is coasting or braking, the alternator voltage is raised above the level of the basic electrical system, which enables the alternator to generate electrical energy and store it temporarily in the battery. When the vehicle accelerates, this energy is used to relieve the load on the alternator, resulting in a fuel saving of up to 3%.

Technology

Concert radio

A technologically-advanced car needs a sound system to match – one designed to enhance the thrilling experience of every drive. The standard Concert radio incorporates an MP3-compatible CD player, AUX-IN socket, SD memory card reader and a 6.5" retractable display. Six high-performance speakers complete with two 'tweeters' work together to produce a sound to enliven any journey.

BOSE® surround sound system

The A1's exterior is a perfect example of modern design. This is complemented inside, where you'll find state-of-the-art technology throughout the cabin. Options include a BOSE® surround sound system with 14 high-performance speakers and a sub-woofer. The speaker housings are enhanced with bevelled edges. Thanks to a 10-channel amplifier, the speakers deliver 465 watts of rich and clear sound, creating a rewarding listening experience. For more information, please see page 66.

LED technology

Xenon Plus headlights are available on all trim levels of the Audi A1. With Xenon Plus headlights you'll benefit from LED daytime-running lights, which provide a distinctive look with a unique, flowing design. Special reflectors focus the light emitted by each diode to create a powerful, uniform beam. And this technology also features in the rear lights, creating a striking design that is unmistakably Audi. For more information, please see page 64 and 70.

Technology package

The Audi A1 keeps many of its most impressive technologies concealed beneath sculptured bodywork and high-class interior finishing. The optional technology package with HDD-based Satellite Navigation system, for example, gives you intuitive control of your car's communication, information, navigation and entertainment functions. The MMI eight-way joystick lets you navigate maps quickly and easily in both 2D and 3D, while you can also use the Audi Music Interface to connect your iPod or the Bluetooth interface to stream music wirelessly from your mobile phone. There's plenty of room to store your favourites too, as 20GB of the hard drive can be used to store up to 8,000 songs. For more information, please see page 64.

Mobile telephone preparation – High with Audi connect

If you choose the technology package, you can also specify mobile telephone preparation – High, with Audi connect. Setting standards in this class of car, it lets you keep completely up to date with online information services and turns your A1 into a Wi-Fi hotspot. So when you take a trip, you won't just be able to check the weather before you leave, you'll also have access to the latest forecast throughout your journey. Audi traffic information online gives you real-time forecasts of the traffic along your chosen route, and will re-direct you if a quicker way is available. Thanks to Wi-Fi connectivity, your passengers can access the internet in the car, so they can check emails and browse the web using a laptop, tablet or smartphone. And finding your destination is easier too, as navigation through Google Earth and Google Street View makes it possible to identify real-life details and search for local landmarks and other points of interest. For more information please see page 67.









SE model equipment

All A1 models have the following items of standard equipment

Engine

Automatic Start-Stop function* for greater fuel and CO₂ efficiency. Comprising:

- Recuperation for optimal energy utilisation
- Energy saving tips feature in the Driver's Information System: including gearshift indicator (if Driver's Information System is fitted)

Wheels, tyres and suspension

15" x 6.5J '7-arm' design alloy wheels with 205/55 R15 tyres

Locking wheel bolts

Dynamic suspension with McPherson front axle and twist-beam rear suspension

Tyre repair kit

Audio and communication

6.5" display screen – manually retractable

AUX-IN socket

Concert radio/single CD player with MP3 file compatibility, 6 speakers in front and rear and 2 tweeters

SD memory card reader

Seats

Driver and front passenger seats with manual height, forwards and backwards adjustment

3 rear seats (Sportback only)

Easy-entry front seats (3-door only)

Split folding rear seats

Zeitgeist cloth upholstery

Interior equipment

3-spoke Sports steering wheel

Steering wheel adjustable for height and reach

Air vent sleeves in matt black

Electric front and rear windows (Sportback only)

Electric front windows (3-door only)

Heat-insulating glass windscreen and side windows

Front floor mats

Heated rear windscreen

Illuminated glovebox

Manual air conditioning

Non-smoking package

Contrasting colour panels on doors, door armrest and centre console (see page 52)



15" x 6.5J '7-arm' design alloy wheels



Body-coloured door mirrors with integrated indicators



Air vent sleeves in matt black



Split folding rear seats

Exterior equipment

Body-coloured door mirrors with integrated indicators

Electrically-operated and heated door mirrors.
Includes heated windscreen washer nozzles

Safety and security

Driver, front passenger, front side and head airbag system

Front passenger airbag deactivation switch

ISOFIX child seat preparation for rear seats

Electronic Stability Programme (ESP), including ABS, EBD, ASR and EDL

First aid kit

Halogen headlights

Rear fog light

Rear head restraints (adjustable) on all seats

Seat belts – 3-point on all seats

Seat belt reminder for all seats

Seat belt height adjustment for front seats

Thatcham Category 1 alarm and immobiliser

Remote central locking with 2 foldaway keys

Tool kit and car jack

Warning triangle



Image shows the A1 SE model with optional Glacier white, metallic paint (2Y) and Xenon light package (WB6)

Sport model equipment

In addition to SE model equipment

Basic RRP
£1,533.33

Total RRP inc VAT
£1,840.00

Wheels, tyres and suspension

16" x 7J '10-spoke' design alloy wheels with 215/45 R16 tyres

Sports suspension with stiffer spring and damper settings. Dynamic (SE) suspension is available in lieu of Sports suspension at no charge

Audio and communication

Mobile telephone preparation – Bluetooth interface. Provides handsfree connection via Bluetooth using mobile phone aerial (depending on compatibility of mobile phone)

Voice control of key telephone and radio functions

Seats

Front Sports seats

Manually adjustable lumbar support in front seats

Tornado cloth upholstery

Exterior equipment

Front fog lights

Polished tailpipe(s)

Interior equipment

3-spoke leather Sports multi-function steering wheel with aluminium inlay (with gear-shift paddles for S tronic transmissions)

Driver's Information System (DIS) –

3.5" monochrome display in the dashboard binnacle. The DIS shows the radio frequency/station or track title, telephone control menu and other display information from the infotainment system such as navigation (if fitted). Also includes an on-board trip computer with short and long-term trip memory, outside temperature display, digital speedometer, door or boot open warning and efficiency program

Washer fluid level indicator

Air vent sleeves in high gloss black

Aluminium trim for control switches, glove compartment, door handles and door sills

Leather handbrake grip and Sports gear knob with aluminium trim



16" x 7J '10-spoke' design alloy wheels



Front fog lights



3-spoke leather Sports multi-function steering wheel



Air vent sleeves in high gloss black



Image shows the A1 Sportback Sport model with optional Samoa orange, metallic paint, (J0) and contrast roof (6H4) in Daytona grey, pearl effect paint (6Y) and 17" '5-V-spoke' design bi-colour alloy wheels (CP3)

S line model equipment

In addition to Sport model equipment

Basic RRP
£1,287.50

Total RRP inc VAT
£1,545.00

Wheels, tyres and suspension

17" x 7.5J '5-twin-spoke' design alloy wheels with 215/40 R17 tyres
S line Sports suspension

Seats

Black Sprint cloth/leather upholstery with embossed S line logo in front seats

Exterior equipment

S line badges on front wings

S line body styling – comprises radiator grille in high gloss black, front sports bumper, side skirts and rear bumper with diffuser

S line roof spoiler

Interior equipment

3-spoke leather Sports multi-function steering wheel with aluminium inlay, S line badging and perforated leather trim (with gear-shift paddles for S tronic transmissions)

Black cloth headlining

Door sill trims with aluminium inlays and S line lettering

LED interior light package. Includes illuminated door handles, footwell lighting, illuminated vanity mirrors, illuminated glovebox, front reading lights and ambient lighting of the centre console. Also includes lighting for the luggage compartment

Centre console in mono.pur

Door armrests in mono.pur. Only available on 1.4 TFSI (185PS) S tronic



Door sill trims with aluminium inlays and S line lettering



Black Sprint cloth/leather upholstery



17" x 7.5J '5-twin-spoke' design alloy wheels



Image shows the A1 Sportback S line model with optional Daytona grey, pearl effect paint (6Y) and Xenon Plus headlights (PX4)

A1 Editions

In addition to S line model equipment

Basic RRP

£791.67

Total RRP inc VAT

£950.00

S line Style Edition

For a true style statement, choose the S line Style Edition. Available in four specially selected colours and boasting attractive specification including 17" bi-colour alloy wheels, Xenon Plus headlights and air vent sleeves, the S line Style Edition provides sophisticated flair both inside and out.

Wheels, tyres and suspension

17" x 7.5J '5-V-spoke' design bi-colour alloy wheels with 215/40 R17 tyres

Paint

Metallic or pearl effect paint with roof contrast line (A1 3-door) or contrast roof (A1 Sportback) in Brilliant black, gloss

Available colours:

- Glacier white, metallic
- Ice silver, metallic
- Misano red, pearl effect
- Phantom black, pearl effect*

Exterior equipment

Black styling package. Radiator grille-frame in highly polished black, with radiator grille, number plate holder and fog light surrounds in matt black. Air inlet blade and diffuser insert in Platinum grey

Exterior mirrors in Brilliant black

Xenon Plus headlights. Includes LED daytime-running lights, rear LED lights, automatic headlight adjustment, dynamic range control and headlight washers

Interior equipment

Air vent sleeves in body colour (when combined with Glacier white, metallic or Misano red, pearl effect paint) or high gloss black (when combined with Ice silver, metallic or Phantom black, pearl effect paint)



Contrast roof and exterior mirrors in Brilliant black



Air vent sleeves in body colour



A1 Editions

In addition to S line model equipment

Basic RRP
£1,041.67

Total RRP inc VAT
£1,250.00

Black Edition

Introducing the A1 Black Edition. With unique titanium finish alloy wheels, black styling package and Xenon Plus headlights, the Black Edition combines sporty styling touches with desirable specification.

Wheels

18" x 7.5J '5-arm Rotor' design alloy wheels in titanium finish, with 225/35 R18 tyres

Exterior equipment

Xenon Plus headlights. Includes LED daytime-running lights, rear LED lights, automatic headlight adjustment, dynamic range control and headlight washers

Privacy glass. Dark tinted glass from B pillar backwards

Black styling package. Radiator grille-frame in highly polished black, with radiator grille, number plate holder and fog light surrounds in matt black. Air inlet blade and diffuser insert in Platinum grey

Interior equipment

Audi sound system. Includes 6-channel amplifier, 6 loudspeakers in front and rear, 2 'tweeters' in A-posts, centre speaker in dashboard and subwoofer. Total output of 180 watts

Electronic climate control. Automatically controls the air temperature, flow rate, distribution and air recirculation, including humidity sensor and defrost button for rapid defrosting of windscreen. Also includes light and rain sensors





Image shows the A1 Black Edition model with optional Phantom black, pearl effect paint (L8)

A1 SE

Engines	Power	Transmissions	CO ₂ g/km	Basic RRP	Total RRP inc VAT	Recommended OTR
1.2 TFSI	86PS	5-speed manual	118	£10,954.17	£13,145.00	£13,790.00
1.6 TDI	105PS	5-speed manual	99	£11,837.50	£14,205.00	£14,850.00

A1 Sport

Engines	Power	Transmissions	CO ₂ g/km	Basic RRP	Total RRP inc VAT	Recommended OTR
1.2 TFSI	86PS	5-speed manual	118	£12,487.50	£14,985.00	£15,630.00
1.4 TFSI	122PS	6-speed manual	124	£12,829.17	£15,395.00	£16,040.00
1.4 TFSI	122PS	7-speed S tronic	119	£14,037.50	£16,845.00	£17,490.00
1.4 TFSI*	140PS	6-speed manual	109	£13,537.50	£16,245.00	£16,890.00
1.4 TFSI*	140PS	7-speed S tronic	109	£14,745.83	£17,695.00	£18,340.00
1.6 TDI	105PS	5-speed manual	99	£13,370.83	£16,045.00	£16,690.00
2.0 TDI	143PS	6-speed manual	108	£14,725.00	£17,670.00	£18,315.00

A1 S line

Engines	Power	Transmissions	CO ₂ g/km	Basic RRP	Total RRP inc VAT	Recommended OTR
1.2 TFSI	86PS	5-speed manual	118	£13,775.00	£16,530.00	£17,175.00
1.4 TFSI	122PS	6-speed manual	124	£14,116.67	£16,940.00	£17,585.00
1.4 TFSI	122PS	7-speed S tronic	122	£15,325.00	£18,390.00	£19,035.00
1.4 TFSI*	140PS	6-speed manual	109	£14,825.00	£17,790.00	£18,435.00
1.4 TFSI*	140PS	7-speed S tronic	109	£16,033.33	£19,240.00	£19,885.00
1.4 TFSI	185PS	7-speed S tronic	139	£16,933.33	£20,320.00	£21,090.00
1.6 TDI	105PS	5-speed manual	99	£14,658.33	£17,590.00	£18,235.00
2.0 TDI	143PS	6-speed manual	108	£16,012.50	£19,215.00	£19,860.00

A1 S line Style Edition

Engines	Power	Transmissions	CO ₂ g/km	Basic RRP	Total RRP inc VAT	Recommended OTR
1.2 TFSI	86PS	6-speed manual	118	£14,566.67	£17,480.00	£18,125.00
1.4 TFSI	122PS	6-speed manual	124	£14,908.33	£17,890.00	£18,535.00
1.4 TFSI	122PS	7-speed S tronic	122	£16,116.67	£19,340.00	£19,985.00
1.6 TDI	105PS	6-speed manual	99	£15,450.00	£18,540.00	£19,185.00

A1 Black Edition

Engines	Power	Transmissions	CO ₂ g/km	Basic RRP	Total RRP inc VAT	Recommended OTR
1.4 TFSI*	140PS	6-speed manual	109	£15,866.67	£19,040.00	£19,685.00
1.4 TFSI*	140PS	7-speed S tronic	109	£17,075.00	£20,490.00	£21,135.00
1.4 TFSI	185PS	7-speed S tronic	139	£17,975.00	£21,570.00	£22,340.00
2.0 TDI	143PS	6-speed manual	108	£17,054.17	£20,465.00	£21,110.00

For engine and model availability, please speak to your Audi Centre.

*1.4 TFSI engine with Audi cylinder-on-demand technology.

Please note: The maximum power output figures are quoted in PS (or Pferdestärke, which is the metric equivalent of brake horsepower). To convert to brake horsepower, divide the PS figure by 1.0139.

Recommended On-The-Road (OTR) retail prices include: delivery charge, half a tank of fuel, number plates at £590.00 (inc. VAT), Road Fund Licence (which may vary depending on model/transmission – see page 89 for details) and first registration fee at £55.00. Vehicle Excise Duty correct at time of going to print, but this may alter to reflect any change in the applicable VED rate.

RRP – Recommended Retail Price. VAT is calculated at 20% but this may alter to reflect any change in the applicable VAT rate.

A1 Sportback SE

Engines	Power	Transmissions	CO ₂ g/km	Basic RRP	Total RRP inc VAT	Recommended OTR
1.2 TFSI	86PS	5-speed manual	118	£11,470.83	£13,765.00	£14,410.00
1.6 TDI	105PS	5-speed manual	99	£12,354.17	£14,825.00	£15,470.00

A1 Sportback Sport

Engines	Power	Transmissions	CO ₂ g/km	Basic RRP	Total RRP inc VAT	Recommended OTR
1.2 TFSI	86PS	5-speed manual	118	£13,004.17	£15,605.00	£16,250.00
1.4 TFSI	122PS	6-speed manual	126	£13,345.83	£16,015.00	£16,660.00
1.4 TFSI	122PS	7-speed S tronic	122	£14,554.17	£17,465.00	£18,110.00
1.4 TFSI*	140PS	7-speed S tronic	109	£15,262.50	£18,315.00	£18,960.00
1.6 TDI	105PS	5-speed manual	99	£13,887.50	£16,665.00	£17,310.00
2.0 TDI	143PS	6-speed manual	108	£15,241.67	£18,290.00	£18,935.00

A1 Sportback S line

Engines	Power	Transmissions	CO ₂ g/km	Basic RRP	Total RRP inc VAT	Recommended OTR
1.2 TFSI	86PS	5-speed manual	118	£14,291.67	£17,150.00	£17,795.00
1.4 TFSI	122PS	6-speed manual	126	£14,633.33	£17,560.00	£18,205.00
1.4 TFSI	122PS	7-speed S tronic	122	£15,841.67	£19,010.00	£19,655.00
1.4 TFSI*	140PS	7-speed S tronic	113	£16,550.00	£19,860.00	£20,505.00
1.4 TFSI	185PS	7-speed S tronic	139	£17,450.00	£20,940.00	£21,710.00
1.6 TDI	105PS	5-speed manual	99	£15,175.00	£18,210.00	£18,855.00
2.0 TDI	143PS	6-speed manual	108	£16,529.17	£19,835.00	£20,480.00

For engine and model availability, please speak to your Audi Centre.

*1.4 TFSI engine with Audi cylinder-on-demand technology.

Please note: The maximum power output figures are quoted in PS (or Pferdestärke, which is the metric equivalent of brake horsepower). To convert to brake horsepower, divide the PS figure by 1.0139.

Recommended On-The-Road (OTR) retail prices include: delivery charge, half a tank of fuel, number plates at £590.00 (inc. VAT), Road Fund Licence (which may vary depending on model/transmission – see page 89 for details) and first registration fee at £55.00. Vehicle Excise Duty correct at time of going to print, but this may alter to reflect any change in the applicable VED rate.

RRP – Recommended Retail Price. VAT is calculated at 20% but this may alter to reflect any change in the applicable VAT rate.

A1 Sportback S line Style Edition

Engines	Power	Transmissions	CO ₂ g/km	Basic RRP	Total RRP inc VAT	Recommended OTR
1.2 TFSI	86PS	6-speed manual	118	£15,083.33	£18,100.00	£18,745.00
1.4 TFSI	122PS	6-speed manual	126	£15,425.00	£18,510.00	£19,155.00
1.4 TFSI	122PS	7-speed S tronic	122	£16,633.33	£19,960.00	£20,605.00
1.6 TDI	105PS	6-speed manual	99	£15,966.67	£19,160.00	£19,805.00

A1 Sportback Black Edition

Engines	Power	Transmissions	CO ₂ g/km	Basic RRP	Total RRP inc VAT	Recommended OTR
1.4 TFSI*	140PS	7-speed S tronic	113	£17,591.67	£21,110.00	£21,755.00
1.4 TFSI	185PS	7-speed S tronic	139	£18,491.67	£22,190.00	£22,960.00
2.0 TDI	143PS	6-speed manual	108	£17,570.83	£21,085.00	£21,730.00



Audi exclusive

Every Audi is intrinsically exclusive. It's the breathtaking design, the exceptional engineering, the Vorsprung durch Technik. But for that special touch, you can specify your new A1 with options from Audi exclusive. It means that you'll be able to drive the car you've always imagined.

Both the exclusive and standard options can be found on the following pages.



Paint

We believe that every part of your car should have a personal touch. Which is why you can choose from a wide range of paint colours and finishes, from standard shades to metallic and pearl effects.

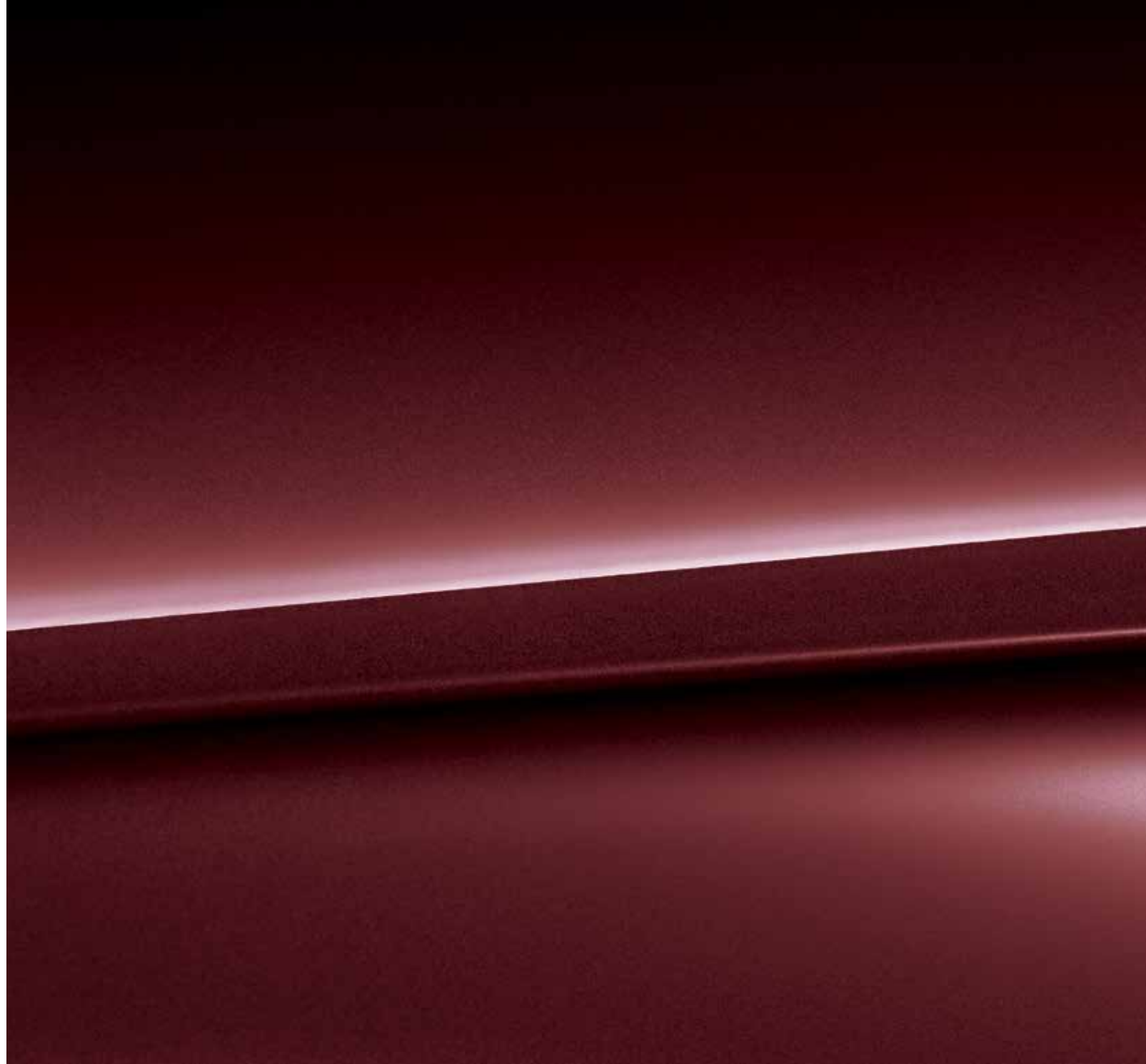

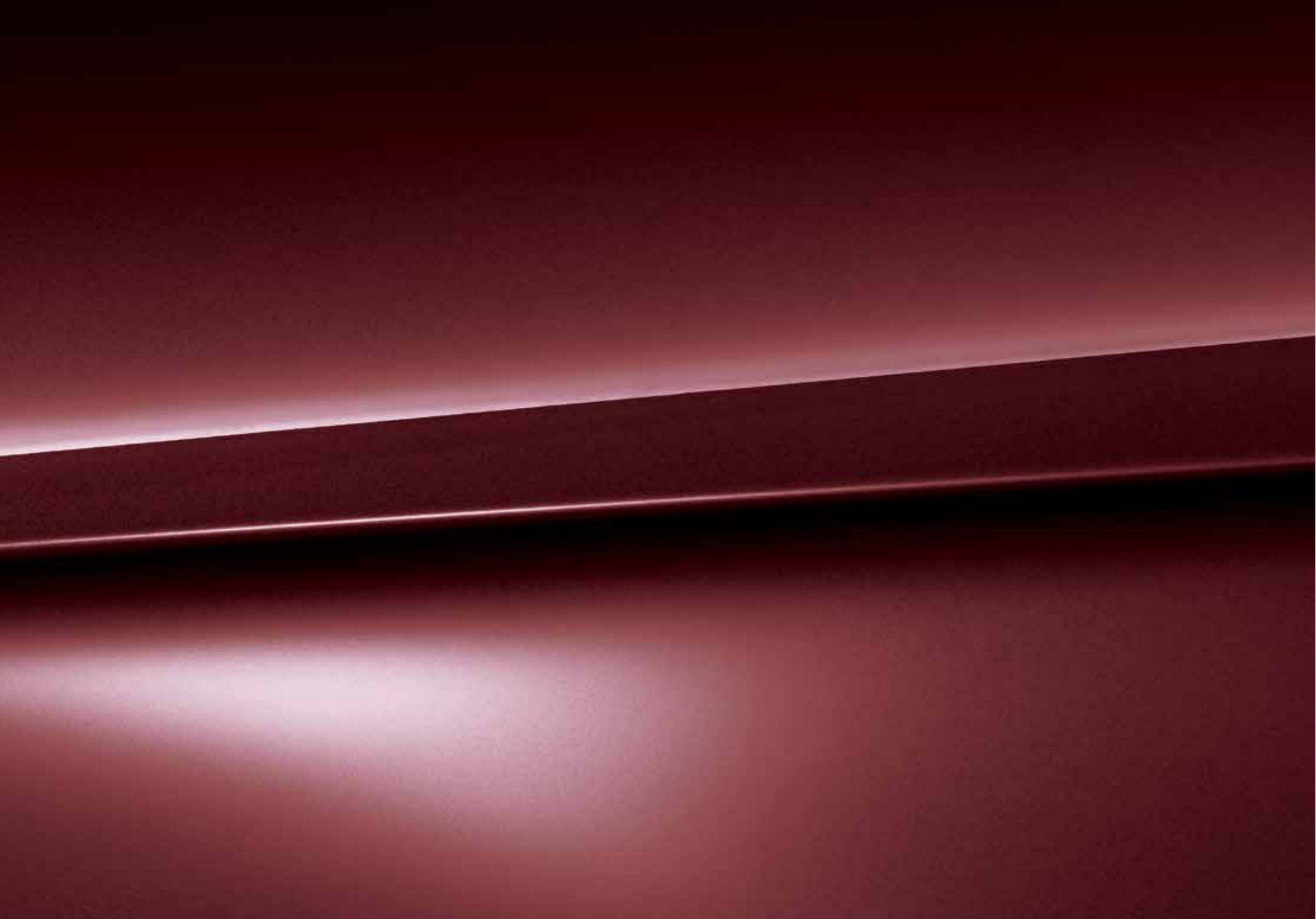

Paint

You can select one of the standard colours shown opposite or, for a different look, choose from the range of optional gloss, metallic or pearl effect finishes.

S line Style Edition models can be specified in in four colours, three of which feature the roof contrast line or contrast roof in Brilliant black – see page 26 for more details.

Standard colours

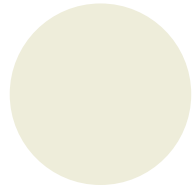

Amalfi white, gloss – Y5

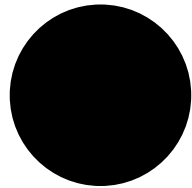

Brilliant black, gloss – A2

Optional colours

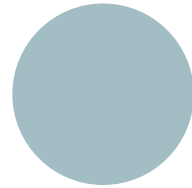

Cumulus blue, gloss – U4

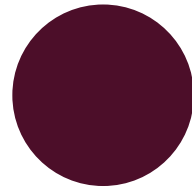

Shiraz red, metallic – 3A

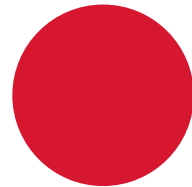

Misano red, pearl effect – N9

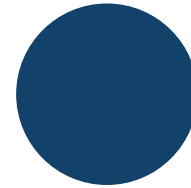

Scuba blue, metallic – S9

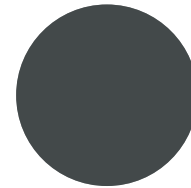

Daytona grey, pearl effect* – 6Y

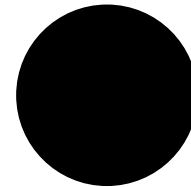

Phantom black, pearl effect – L8



Glacier white, metallic – 2Y

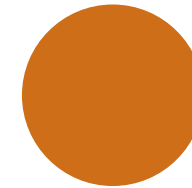

Samoa orange, metallic – J0

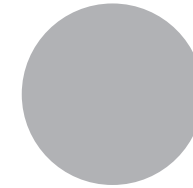

Ice silver, metallic – P5

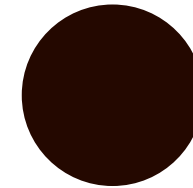

Teak brown, metallic – 4U

Options are subject to availability and may extend delivery.

All the colour swatches on this page are matched as accurately as possible to the actual paint colours used. However, due to print processes, Audi UK cannot guarantee that colours shown are 100% accurate.

Visit your local Audi Centre for a more accurate colour swatch.

*S line colour only.

RRP – Recommended Retail Price.

VAT is calculated at 20% but this may alter to reflect any change in the applicable VAT rate.

Cumulus blue optional colour

Basic RRP
£166.67

Total RRP inc VAT
£200.00

Other optional colours

Basic RRP
£283.33

Total RRP inc VAT
£340.00

Paint

Audi exclusive

Everyone has a favourite colour. No matter what yours is, Audi exclusive provides a range of unique colours that have been designed to set your car apart. Choose from the swatches here, or specify any other paint colour in the Audi range. Whether it's Sepang blue from the Audi R8 or Alpine white from the original Audi quattro, the choice is yours.

Customised paint

If you have a particular colour in mind, we'll mix the exact metallic or pearl-effect shade you want.*

*Customised paint is subject to factory approval, and is available for metallic and pearl-effect water-based paints only. Three-colour process colours and two-tone schemes are not available.

**Visit your local Audi Centre for colour samples.

All the colour swatches on this page are matched as accurately as possible to the actual paint colours used. However, due to print processes, Audi UK cannot guarantee that colours shown are 100% accurate.

Visit your local Audi Centre for a more accurate colour swatch.

RRP - Recommended Retail Price.

VAT is calculated at 20% but this may alter to reflect any change in the applicable VAT rate.

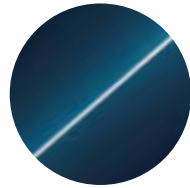

Palace blue, pearl effect

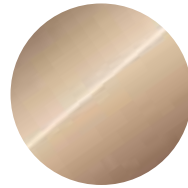

Sand beige, pearl effect

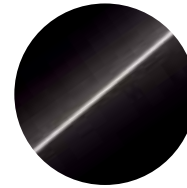

Saddle brown, pearl effect

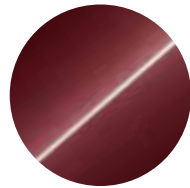

Classic red, pearl effect

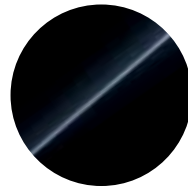

Mamba black, metallic

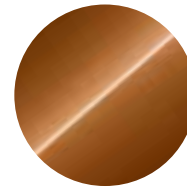

Ipanema brown, metallic



Any colour in the Audi range or 100 exclusive colours to choose from**



Customised paint

Audi exclusive

Basic RRP
£1,533.33

Total RRP inc VAT
£1,840.00

Customised*

Basic RRP
£1,950.00

Total RRP inc VAT
£2,340.00

Roof contrast line

Choose one of the optional roof contrast line colours opposite to complement your paint, enhancing the design of your A1.



Amalfi white, gloss - Y5

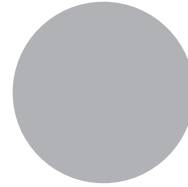

Ice silver, metallic - P5

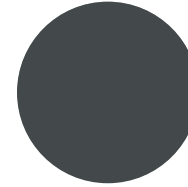

Daytona grey, pearl effect - 6Y

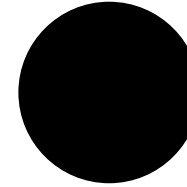

Brilliant black, gloss - A2

Roof contrast line

Basic RRP
£291.67

Total RRP inc VAT
£350.00



Roof contrast line only available on the A1 3-door.

Roof contrast line

Paint and roof contrast line combinations

To help you choose the exterior design of your A1, please use this guide which shows possible paint and roof contrast line combinations.

Order Code		Amalfi white, gloss (Y5)	Ice silver, metallic (P5)	Daytona grey, pearl effect (6Y)	Brilliant black, gloss (A2)
Y5	Amalfi white, gloss	—	●	●	●
A2	Brilliant black, gloss	—	—	—	—
U4	Cumulus blue, gloss	●	●	●	—
P5	Ice silver, metallic	—	—	—	●
S9	Scuba blue, metallic	●	●	●	—
3A	Shiraz red, metallic	●	●	●	●
4U	Teak brown, metallic	●	●	—	—
2Y	Glacier white, metallic	—	●	●	●
J0	Samoa orange, metallic	—	●	●	●
L8	Phantom black, pearl effect	—	●	●	—
6Y	Daytona grey, pearl effect	—	●	—	—
N9	Misano red, pearl effect	—	●	—	●

Options are subject to availability and may extend delivery.

- = Not available
- = Available
- S = Standard

Contrast roof

Choose one of the optional contrast roof colours opposite to complement your paint, enhancing the design of your A1 Sportback.

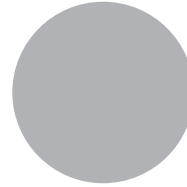

Ice silver, metallic - P5

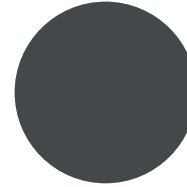

Daytona grey, pearl effect - 6Y

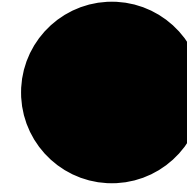

Brilliant black, gloss - A2

Contrast roof

Basic RRP

£333.33

Total RRP inc VAT

£400.00



Contrast roof only available on the A1 Sportback.

Contrast roof

Paint and contrast roof combinations

To help you choose the exterior design of your A1 Sportback, please use this guide which shows possible paint and contrast roof combinations.

Order Code		Ice silver, metallic (P5)	Daytona grey, pearl effect (6Y)	Brilliant black, gloss (A2)
Y5	Amalfi white, gloss	—	—	—
A2	Brilliant black, gloss	—	—	—
U4	Cumulus blue, gloss	●	●	●
P5	Ice silver, metallic	—	—	●
S9	Scuba blue, metallic	●	—	●
3A	Shiraz red, metallic	●	—	●
4U	Teak brown, metallic	●	—	—
2Y	Glacier white, metallic	●	●	●
J0	Samoa orange, metallic	—	●	●
L8	Phantom black, pearl effect	●	●	—
6Y	Daytona grey, pearl effect	●	—	●
N9	Misano red, pearl effect	●	●	●

Options are subject to availability and may extend delivery.

- = Not available
- = Available
- S = Standard

Upholstery

It's important to feel comfortable on the road. Just choose from our range of luxury upholstery materials and textures, including additional support and colour options, for complete relaxation while you drive.





Upholstery

A1 SE

Your chosen upholstery will be complemented with a contrasting centre console, door armrest and door panels including speaker housings. When black upholstery is chosen, these panels will be trimmed in black.

Air vent sleeves are also available to complement your upholstery colour – see page 56 for more details.

	SE	Sport	S line	S Line Style Edition	Black Edition	Basic RRP	Total RRP inc VAT
Zeitgeist cloth	S	-	-	-	-	No charge	No charge
Style cloth*	P	-	-	-	-	No charge	No charge
Milano leather*	P	-	-	-	-	£1,020.83	£1,225.00

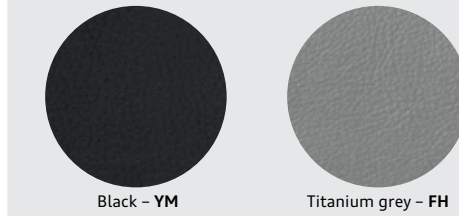
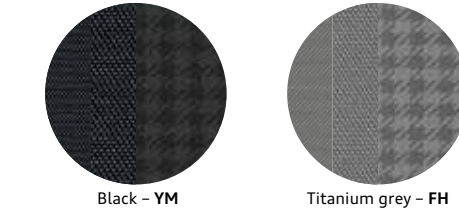
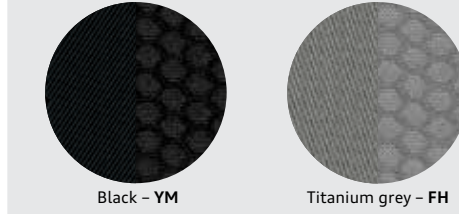

Options are subject to availability and may extend delivery.

*Only available in combination with Media Style package – see page 50 for further details.

- = Not available
- = Available
- S = Standard
- P = Available as part of a package – see page 50 for details

RRP – Recommended Retail Price.

VAT is calculated at 20% but this may alter to reflect any change in the applicable VAT rate.



Black Zeitgeist cloth – YM



Black/Titanium grey Tornado cloth – FK

Upholstery

A1 Sport

Choose your favourite upholstery from the swatches shown opposite to give your car's interior the look and feel you want.

All Sport model upholstery colours receive contrast colour seat stitching.

*Only available in combination with Media Style package – see page 50 for further details.







A1 S line/ A1 S line Style Edition/ A1 Black Edition

Options are subject to availability and may extend delivery.

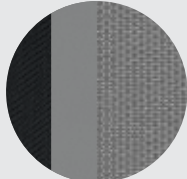
– = Not available
• = Available
S = Standard
P = Available as part of a package
– see page 50 for details

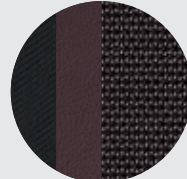
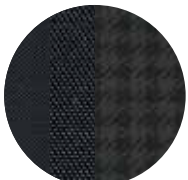
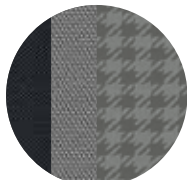
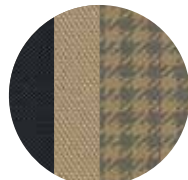
RRP – Recommended Retail Price.

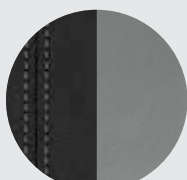
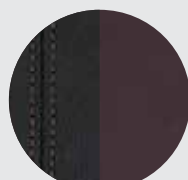
VAT is calculated at 20% but this may alter to reflect any change in the applicable VAT rate.

							SE	Sport	S line	S Line Style Edition	Black Edition	Basic RRP	Total RRP inc VAT	
Tornado cloth							–	S	–	–	–	No charge	No charge	
	Black – YS	Black/Titanium grey – FK	Black/Wasabi green – YP	Black/Garnet red – YV										
	Style cloth*							–	P	–	–	–	No charge	No charge
		Black/Black – YS	Black/Titanium grey – FK	Black/Velvet beige – YR	Black/Garnet red – YV									
Milano leather							–	•	–	–	–	£1,020.83	£1,225.00	
	Black/Black – YS	Black/Titanium grey – FK	Black/Garnet red – YV											
	Sprint cloth/ leather							–	–	S	S	S	No charge	No charge
Black – QF														
Silk Nappa leather							–	–	•	•	•	£541.67	£650.00	
	Black – QF													

Upholstery

Audi exclusive

With Audi exclusive, you can specify your seats in Fine Nappa leather in an array of different colours shown to the right.

Select just one all-over shade for each seat, or customise each panel in two or more complementary colours from the distinctive Audi exclusive palette. You can even choose the colour of the decorative stitching – to match or contrast with your chosen upholstery – from this varied collection. Whatever combination you decide upon, we think you'll be extremely comfortable with the result.



Chestnut brown



Jet grey



Alabaster white

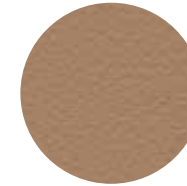

Sand beige

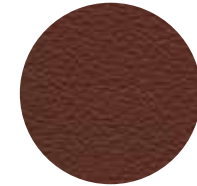

Saddle brown

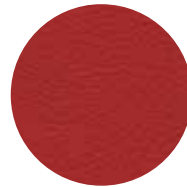

Crimson red



Magnolia white



Havana brown

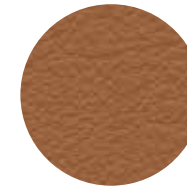

Cognac brown

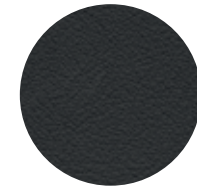

Night blue

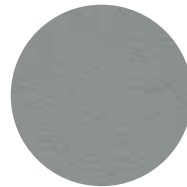

Cloudy grey

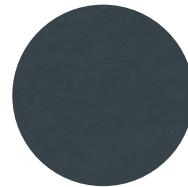

Smoky blue

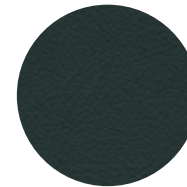

Iceland green

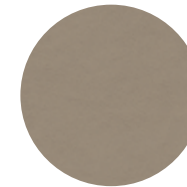

Powder beige



Classic red

Upholstery

Audi exclusive

Order Code		SE	Sport	S line	S Line Style Edition	Black Edition	Basic RRP	Total RRP inc VAT
PYA S3G	Audi exclusive leather package 1 in Fine Nappa leather. Includes leather-covered seat upholstery, door trim inserts and floor mats with leather piping. Backrest covers and seat add-on parts come in the interior trim colour*	-	•	-	-	-	£2,108.33	£2,530.00
		-	-	•	•	•	£1,691.67	£2,030.00
YSI 7HB S3G	Audi exclusive extended leather. Lower centre console and door armrests in Audi exclusive leather	-	•	•	•	•	£925.00	£1,110.00

Options are subject to availability and may extend delivery.

- = Not available
- = Available
- S = Standard

*Leather, stitching and piping (where applicable) can be specified in a variety of colours from the Audi exclusive range.

RRP – Recommended Retail Price.

VAT is calculated at 20% but this may alter to reflect any change in the applicable VAT rate.



Super Sports seats (Q4Q) with Audi exclusive leather package 1 in Fine Nappa leather (PYA), Audi exclusive extended leather (YSI/7HB) and Audi exclusive leather controls package (YRB) in Alabaster white leather with Crimson red stitching

Upholstery

Audi exclusive line

Audi exclusive is ultimately about choice – but if you'd rather leave some of the decisions in the capable hands of our designers, the expert team at quattro GmbH have compiled Audi exclusive line, combining some of the most popular elements of the exclusive range in one, beautifully coordinated package.

Options are subject to availability and may extend delivery.

- = Not available
 • = Available
 S = Standard

RRP – Recommended Retail Price.

VAT is calculated at 20% but this may alter to reflect any change in the applicable VAT rate.

Order Code		SE	Sport	S line	S Line Style Edition	Black Edition	Basic RRP	Total RRP inc VAT
WQK	Audi exclusive line. Only in conjunction with LED interior light package (QQ1)	-	•	-	-	-	£1,333.33	£1,600.00



Alabaster white/Jet grey (UG)

This package includes

- ▶ Sports seats with Jet grey Fine Nappa leather seat side sections. Seat centre section in Style cloth with Sports stripes in Alabaster white Alcantara and contrasting stitching in Alabaster white
- ▶ Black cloth headlining
- ▶ Air vents in high-gloss black
- ▶ Floor mats in black with piping in Jet grey
- ▶ Lower centre console in Jet grey mono.pur with contrasting stitching in Alabaster white
- ▶ Steering wheel rim and gear-lever gaiter come in interior trim colour with contrasting Alabaster white stitching





Media Style package

This package provides a distinctive look and feel for your car's cabin, enabling you to integrate the audio system with your digital music player and stay in touch using Bluetooth technology.

You can also upgrade to a leather interior and choose contrasting air vent sleeve colours – see page 56.

Order Code	SE	Sport	S line	S Line Style Edition	Black Edition	Basic RRP	Total RRP inc VAT
WMS 1XW	●	–	–	–	–	£1,137.50	£1,365.00
	–	●	–	–	–	£450.00	£540.00

Media Style package. Includes Audi Music Interface, Bluetooth interface, Driver's Information System, leather multi-function steering wheel and LED interior light package. Also includes Style cloth upholstery, air vent sleeves in high gloss black, white or contrasting colour to your interior. Centre console, door armrest, door panels and speaker housings in contrasting mono.pur. Also includes additional SD card reader and preparation for Satellite Navigation.* Not available in combination with connectivity package (PNV)

Options are subject to availability and may extend delivery.

- = Not available
- = Available
- S = Standard

*Navigation function and map data is available as a retrofit solution from Audi Genuine Accessories. Please contact your Audi Centre for full details.

RRP – Recommended Retail Price.

VAT is calculated at 20% but this may alter to reflect any change in the applicable VAT rate.



Media Style package with optional Milano leather (N5W) in Black/Garnet red (YV)



Colour and trim guide

Interior trim colours

A1 SE

To help you choose the right interior for your new Audi A1, please use this guide, showing the carpet, dashboard and headlining colours that have been matched to your chosen upholstery.

A1 Sport

A1 S line/ A1 S line Style Edition/ A1 Black Edition

Options are subject to availability and may extend delivery.

– = Not available
● = Available
S = Standard

Order Code	Seat centre section	Seat side section	Contrast stitching	Dashboard	Carpet	Centre console, armrest, map pocket, speaker grilles	Headlining	Media Style package		
								Zeitgeist cloth (NOL)	Style cloth (N2D)	Milano leather (N5W)
YM	Black	Black	—	Black	Black	Black	Titanium grey	●	●	●
FH	Titanium grey	Titanium grey	—	Black	Titanium grey	Titanium grey	Titanium grey	●	●	●

Order Code	Seat centre section	Seat side section	Contrast stitching	Dashboard	Carpet	Centre console, armrest, map pocket, speaker grilles	Headlining	Media Style package			
								Tornado cloth (N2T)	Milano leather (N5W)	Style cloth (N2D)	Milano leather (N5W)
YS	Black	Black	Grey	Black	Black	Black	Titanium grey	●	●	●	●
FK	Titanium grey	Black	Titanium grey	Black	Black	Titanium grey	Titanium grey	●	●	●	●
YP	Wasabi green	Black	Wasabi green	Black	Black	Wasabi green	Titanium grey	●	—	—	—
YV	Garnet red	Black	Garnet red	Black	Black	Garnet red	Titanium grey	●	●	●	●
YR	Velvet beige	Black	Velvet beige	Black	Black	Velvet beige	Titanium grey	—	—	●	—

Order Code	Seat centre section	Seat side section	Contrast stitching	Dashboard	Carpet	Centre console, armrest, map pocket, speaker grilles	Headlining	Media Style package	
								Sprint cloth/leather (N7V)	Silk Nappa leather (NOR)
QF	Black	Black	Dark silver	Black	Black	Black	Black	●	●



Tornado cloth, Black/Wasabi green (YP)

Interior styling

For a more individual finish you can choose from a range of colour air vent sleeves and interior elements, to help you personalise the interior of your A1.





Air vent sleeves

Choose an air vent sleeve to complement or contrast with your chosen interior colour.

Matt finish



Matt black - 5MA

High gloss finish



Black - 5MB



Titanium grey - 5MC



White - 5MJ

Metallic finish



Aluminium look - 5MD



Velvet beige - 5MQ



Garnet red - 5MR



Wasabi green - 5MN

Options are subject to availability and may extend delivery.

- = Not available
• = Available
S = Standard

RRP - Recommended Retail Price.

VAT is calculated at 20% but this may alter to reflect any change in the applicable VAT rate.

Air vent sleeves

Order Code		SE	Sport	S line	S Line Style Edition	Black Edition	Basic RRP	Total RRP inc VAT
5MA	Matt black	S	-	-	-	-	No charge	No charge
5MB	High gloss black	●	S	S	-	S	£83.33	£100.00
5MD	Aluminium look	-	●	●	-	●	£83.33	£100.00
-	High gloss colour contrast air vent sleeves. Available in 5 colours. See opposite page for colour availability. Please note that colour contrast air vent sleeves can be selected to complement corresponding interior colour or contrast with black upholstery	●	●	-	-	-	£83.33	£100.00
	In combination with Media Style package	S	S	-	-	-	No charge	No charge

Options are subject to availability and may extend delivery.

- = Not available
 ● = Available
 S = Standard

RRP – Recommended Retail Price.

VAT is calculated at 20% but this may alter to reflect any change in the applicable VAT rate.

Interior elements

Choose from these contrast interior elements to complement your exterior paint colour.



Amalfi white – YIF



Ice silver – YIG



Daytona grey – YIH



Misano red – YII



Glacier white – YIJ



Samoa orange – YIK

Options are subject to availability and may extend delivery.

– = Not available
• = Available
S = Standard

RRP – Recommended Retail Price.

VAT is calculated at 20% but this may alter to reflect any change in the applicable VAT rate.

Interior elements

Order Code	SE	Sport	S line	S Line Style Edition	Black Edition	Basic RRP	Total RRP inc VAT
-	●	●	-	-	-	£416.67	£500.00

Interior elements in contrast colour. Available in 5 colours. See opposite page for colour availability.*
 Please note that colour contrast interior elements can be selected to complement corresponding exterior paint colour. Rear-view mirror trim not available in combination with auto-dimming rear-view mirror. Not available in combination with high gloss colour contrast air vent sleeves, Media Style package, Audi exclusive line, Audi exclusive extended leather, Audi exclusive leather controls package, Audi exclusive black suede controls package or Audi exclusive leather-covered steering wheel rim

- = Not available
 ● = Available
 S = Standard

*Please note that the choice of exterior paint colours is restricted dependent on the colour contrast chosen. Please contact your Audi Centre for full details.

RRP – Recommended Retail Price.

VAT is calculated at 20% but this may alter to reflect any change in the applicable VAT rate.

Options

Every driver has different needs, which is why we have created some useful options to further enhance your car. For extra comfort, support, style or function, you can choose from a variety of additional features, tailoring everything from your infotainment and audio equipment to your wheels and lighting.





Wheels, tyres and suspension

Choose a set of specially-selected alloy wheels to subtly enhance the way your A1 looks.



15" x 6.5J '6-hole' design
bi-colour alloy wheels - C5L



16" x 7J '7-arm Dynamic'
design alloy wheels - CQ3



17" x 7.5J '5-arm' design
bi-colour alloy wheels - CP2



17" x 7.5J '5-V-spoke' design
bi-colour alloy wheels - CP3



17" x 7.5J '7-spoke'
design alloy wheels - C4F



18" x 7.5J '7-twin-spoke'
design alloy wheels - C6I

Wheels, tyres and suspension

Order Code		SE	Sport	S line	S line Style Edition	Black Edition	Basic RRP	Total RRP inc VAT
C5L	15" x 6.5J '6-hole' design bi-colour alloy wheels with 205/55 R15 tyres	●	—	—	—	—	£129.17	£155.00
CQ3	16" x 7J '7-arm Dynamic' design alloy wheels with 215/45 R16 tyres	—	●	—	—	—	£129.17	£155.00
CP2	17" x 7.5J '5-arm' design bi-colour alloy wheels with 215/40 R17 tyres	—	●	—	—	—	£383.33	£460.00
		—	—	—	●	—	No charge	No charge
CP3	17" x 7.5J '5-V-spoke' design bi-colour alloy wheels with 215/40 R17 tyres	—	●	—	S	—	£466.67	£560.00
C4F	17" X 7.5J '7-spoke' design alloy wheels with 215/40 R17 tyres	—	●	—	—	—	£383.33	£460.00
C6I	18" x 7.5J '7-twin-spoke' design alloy wheels with 225/35 R18 tyres	—	—	●	—	—	£341.67	£410.00
UCO	Dynamic suspension. Fine-tuned to deliver a more comfortable drive. Not available in combination with 18" x 7.5J '7-twin-spoke' design alloy wheels	S	●	●	●	—	No charge	No charge
PDA	Sports suspension with stiffer spring and damper settings	—	S	●	●	●	No charge	No charge

Options are subject to availability and may extend delivery.

— = Not available
● = Available
S = Standard

RRP – Recommended Retail Price.

VAT is calculated at 20% but this may alter to reflect any change in the applicable VAT rate.

Packages

Some items work well together, which is why we've created these special packages. They provide increased convenience and value by combining several of our most popular options.

Options are subject to availability and may extend delivery.

- = Not available
- = Available
- S = Standard

RRP - Recommended Retail Price.

VAT is calculated at 20% but this may alter to reflect any change in the applicable VAT rate.

Order Code		SE	Sport	S line	S line Style Edition	Black Edition	Basic RRP	Total RRP inc VAT
WBI	Comfort package. Acoustic parking system (rear only), cruise control, auto-dimming rear-view mirror and light and rain sensors	•	•	•	•	-	£504.17	£605.00
		-	-	-	-	•	£400.00	£480.00
	In combination with Xenon light package	•	•	-	-	-	£400.00	£480.00
PNQ	Technology package. Satellite Navigation system - HDD-based with Audi Music Interface. Route planning and guidance using voice, pictogram and 3D mapping. 7-digit postcode recognition. Includes AM/FM tuner with TP memo function. Single front-loading CD/DVD player with MP3 compatibility, suitable for audio and DVD playback. Third generation MMI system including high resolution (800x480) 6.5" colour TFT display, two SD card readers and 40GB hard drive, 20GB of which can be used to store up to 8,000 songs. HDD Navigation functionality includes advanced speech recognition, 3D and topographical mapping display and advanced 3D building display. Please note that luggage capacity is reduced with this option	-	•	•	•	•	£1,145.83	£1,375.00
	In combination with Media Style package	-	•	-	-	-	£1,020.83	£1,225.00
WB6	Xenon light package. Includes Xenon Plus headlights with headlight washers, LED interior light package and light and rain sensors. Not available on 1.4 TFSI (122PS) Sport S tronic 119g/km (3-door)	•	•	-	-	-	£912.50	£1,095.00
	In combination with Media Style package	•	•	-	-	-	£787.50	£945.00
WB6	Xenon light package. Includes Xenon Plus headlights, LED interior light package and light and rain sensors. Only available on 1.4 TFSI (122PS) Sport S tronic 119g/km (3-door)	-	•	-	-	-	£829.17	£995.00
	In combination with Media Style package	-	•	-	-	-	£704.17	£845.00



3-spoke leather Sports multi-function steering wheel



Satellite Navigation - HDD-based



Audio and communication

Stay in touch using our range of communication functions, and give each journey its own soundtrack with our advanced audio equipment.

You can also opt for the technology package, which combines some of the features shown here with the Satellite Navigation system – HDD-based. See page 64 for further details.

Options are subject to availability and may extend delivery.

- = Not available
- = Available
- S = Standard

*When combined with Technology package.

RRP – Recommended Retail Price.

VAT is calculated at 20% but this may alter to reflect any change in the applicable VAT rate.

Order Code		SE	Sport	S line	S line Style Edition	Black Edition	Basic RRP	Total RRP inc VAT
9Q7	Driver's Information System (DIS). 3.5" monochrome display in the dashboard binnacle. The DIS shows the radio frequency/station or track title, telephone control menu and other display information from the infotainment system such as navigation (if fitted). Also includes an on-board trip computer with short and long-term trip memory, outside temperature display, digital speedometer, door or boot open warning and efficiency program	•	S	S	S	S	£158.33	£190.00
9VD	Audi sound system. Includes 6-channel amplifier, 6 loudspeakers in front and rear, 2 tweeters in A-posts, centre speaker in dashboard and subwoofer. Total output of 180 watts	•	•	•	•	S	£212.50	£255.00
9VK	BOSE® surround sound system. 5.1 surround sound* with dynamic noise-compensation, 10-channel amplifier, 14 loudspeakers including centre speaker in the dashboard and 2 surround loudspeakers in the rear shelf. Total output of 465 watts. Speaker housings with bevelled edge plus lighting for door speakers. Only available in combination with LED interior light package. Not available on 1.4 TFSI (140PS) Sport 109g/km (Sportback). Please note that luggage capacity is reduced with this option	•	•	•	•	–	£575.00	£690.00
		–	–	–	–	•	£362.50	£435.00
PNU	Satellite Navigation system – SD card-based. Route planning and guidance using voice, pictogram and 2D mapping. 7-digit postcode recognition. Includes AM/FM tuner with TP memo function. Single front-loading CD player with MP3 compatibility. Third generation MMI system including high resolution (400x240) 6.5" colour TFT display and two SD card readers (one of which is used by the Navigation SD card). Navigation functionality includes advanced speech recognition. Also includes Audi Music Interface and Bluetooth interface with Bluetooth audio streaming. Only in combination with Driver's Information System and multi-function steering wheel. Not in combination with Connectivity package	•	–	–	–	–	£979.17	£1,175.00
		–	•	•	•	•	£729.17	£875.00
		•	•	–	–	–	£475.00	£570.00

In combination with Media Style package



BOSE® surround sound system

Audio and communication

Order Code		SE	Sport	S line	S line Style Edition	Black Edition	Basic RRP	Total RRP inc VAT
PNV	Connectivity package. Audi Music Interface, Bluetooth interface including voice control and Bluetooth audio streaming. Also includes additional SD card reader and preparation for Satellite Navigation.* Only in combination with Driver's Information System and multi-function steering wheel. Not in combination with Media Style package, technology package or Satellite Navigation – SD card-based	●	–	–	–	–	£504.17	£605.00
		–	●	●	●	●	£254.17	£305.00
9ZX	Mobile telephone preparation – Bluetooth interface. Provides handsfree connection via Bluetooth using mobile phone aerial. Please contact your Audi Centre for phone compatibility. Only in combination with Driver's Information System and multi-function steering wheel	●	S	S	S	S	£208.33	£250.00
9ZF 6E3	Mobile telephone preparation – Low with Bluetooth. Provides handsfree connection via Bluetooth using mobile phone aerial. Alternatively, it can use a cradle with charging facility for optimal reception via external aerial. Cradle available at extra cost – please contact your Audi Centre for phone compatibility. Includes front centre armrest. Only in combination with Driver's Information System and multi-function steering wheel	●	–	–	–	–	£458.33	£550.00
		–	●	●	●	●	£250.00	£300.00
9ZW	Mobile telephone preparation – High with Audi connect. Audi connect provides access to a number of innovative online services via an internal UMTS (3G) module. Audi connect online services include: navigation using Google Earth images and Google Street View, destination entry via Google Maps or myAudi, online point of interest search and information services such as weather forecasts and the latest world news. Audi connect also includes Audi traffic information online, which gives accurate real-time forecasts of the traffic situation along the chosen route. The traffic situation can be displayed on the navigation map or Google Earth image. Audi connect can also create a Wi-Fi hotspot in the car for convenient internet access using a mobile device (e.g. laptop or tablet). Many Audi connect features can be simply operated via MMI Navigation Plus, the multi-function steering wheel or the voice control system. Only in combination with Technology package (PNQ)	–	●	●	●	●	£291.67	£350.00
	Important connectivity information: An external data source is required to enable the Audi connect online services. One of the two following external data sources can be used: ¹ 1. A mobile telephone with Bluetooth SIM Access Profile ² 2. A separate SIM card which can be inserted in the included SIM card reader. When a separate SIM card is used, hands free phone calls are possible using the SIM card or by connecting a different mobile telephone via Bluetooth Hands Free Profile							
7A2	CD changer. For six CDs with MP3 compatibility	●	●	●	●	●	£270.83	£325.00

*Navigation function and map data is available as a retrofit solution from Audi Genuine Accessories. Please contact your Audi Centre for full details.

¹Online services are only available for mobile phone contracts or SIM cards which include a data option and only within the coverage of the mobile phone network; there may be additional costs for the use of these services (charges and billing correspond to the personal mobile phone contract or SIM card contract). Due to high data volumes, a mobile phone contract including an unlimited or high usage data plan is strongly recommended. The content and scope of the online based services offered may vary.

²To check the compatibility of your mobile phone and whether it has SIM Access Profile compatibility, please visit www.audi.co.uk/owners-area/phone-compatibility.html

Options are subject to availability and may extend delivery.

– = Not available
● = Available
S = Standard

RRP – Recommended Retail Price.

VAT is calculated at 20% but this may alter to reflect any change in the applicable VAT rate.

Interior equipment

Specify every detail of your car's interior with this wide range of options.

Order Code		SE	Sport	S line	S line Style Edition	Black Edition	Basic RRP	Total RRP inc VAT
4F2	Advanced key. Access and authorisation system which automatically exchanges data between key and vehicle, allowing the driver to keep the key in their pocket or bag at all times. To unlock and open, simply lift the driver or passenger door handle. To lock, press the button on the handle. Pressing the start/stop button integrated in the centre console starts and stops the engine	●	●	●	●	●	£325.00	£390.00
6Q5	Aluminium gear knob. Only on manual models	●	●	●	●	●	£108.33	£130.00
8T2	Cruise control. For holding any speed above 25mph. Also available as part of the Comfort package – see page 64 for details	●	●	●	●	●	£187.50	£225.00
9AK 8N6 4GP	Electronic climate control. Automatically controls the air temperature, flow rate, distribution and air recirculation, including humidity sensor and defrost button for rapid defrosting of windscreen. Also includes light and rain sensors	●	●	●	●	S	£275.00	£330.00
	In combination with Comfort package or Xenon light package	●	●	●	●	—	£170.83	£205.00
PE6	4-seat option. Includes only 2 rear seat belts and headrests for the rear seats. A1 Sportback only	●	●	●	●	●	No charge	No charge
Q4Q	Super Sports seats. With integrated headrests and shaped side bolsters giving increased lateral support. Easy-entry front seats with 2-way lumbar support. Manually adjustable height, forwards and backwards position, headrest and seat back angle. Only in combination with Silk Nappa leather (NOR) or Audi exclusive leather package 1 in Fine Nappa leather (PYA)	—	—	●	●	●	£500.00	£600.00
4A3	Heated front seats. Individually controlled variable temperature adjustment	●	●	●	●	●	£179.17	£215.00
QQ1	LED interior light package. Includes illuminated door handles, illuminated front door armrests, footwell lighting, illuminated vanity mirrors, illuminated glovebox, front reading lights and ambient lighting of the centre console. Also includes lighting for the luggage compartment	●	●	S	S	S	£125.00	£150.00
8N6 4GP	Light and rain sensors. Automatic headlight activation, automatic windscreen wipers, coming home/leaving home function and sun band for windscreen	●	●	●	●	S	£104.17	£125.00
4L6 8N6 4GP	Auto-dimming rear-view mirror. Includes light and rain sensors	●	●	●	●	—	£204.17	£245.00
	In combination with electronic climate control or Xenon light package	—	—	—	—	●	£100.00	£120.00
		●	●	●	●	—	£100.00	£120.00
8N7 4L6 4GP	High-beam assist. Automatically adjusts headlights from high-beam to dipped-beam when another vehicle is approaching. Includes auto-dimming rear-view mirror and light and rain sensors. Only in combination with Driver's Information System	●	●	●	●	—	£287.50	£345.00
	In combination with Comfort package	—	—	—	—	●	£183.33	£220.00
	In combination with Xenon light package	●	●	●	●	●	£83.33	£100.00
		●	●	—	—	—	£183.33	£220.00

Options are subject to availability and may extend delivery.

— = Not available
● = Available
S = Standard

RRP – Recommended Retail Price.

VAT is calculated at 20% but this may alter to reflect any change in the applicable VAT rate.

Interior equipment

Order Code		SE	Sport	S line	S line Style Edition	Black Edition	Basic RRP	Total RRP inc VAT
QE4	Luggage package. Comprising combi-net for fixing into luggage compartment, 12V socket, additional light within luggage compartment, bag hooks, tensioning strap and storage compartment under load floor	●	●	●	●	●	£79.17	£95.00
QE1	Storage package. Net on side of centre console and lockable glove compartment. Includes bag hooks on left and right in rear passenger compartment on A1 3-door. Also includes storage tray with 3 cupholders between rear passenger seats on A1 3-door and on A1 Sportback when ordered in combination with 4-seat option	●	●	●	●	●	£91.67	£110.00
QE5	Storage and luggage package	●	●	●	●	●	£170.83	£205.00
6NQ	Cloth headlining – Black. Only in combination with LED interior light package	●	●	S	S	S	£137.50	£165.00
6E3	Front centre armrest with storage compartment	●	●	●	●	●	£104.17	£125.00
0TD	Rear floor mats	●	●	●	●	●	£50.00	£60.00
9JD	Smoker's package. Includes ashtray and cigarette lighter. Replaces storage compartment and 12V socket	●	●	●	●	●	£16.67	£20.00

Options are subject to availability and may extend delivery.

- = Not available
- = Available
- S = Standard

RRP – Recommended Retail Price.

VAT is calculated at 20% but this may alter to reflect any change in the applicable VAT rate.



Electronic climate control



Heated front seats



Driver's Information System

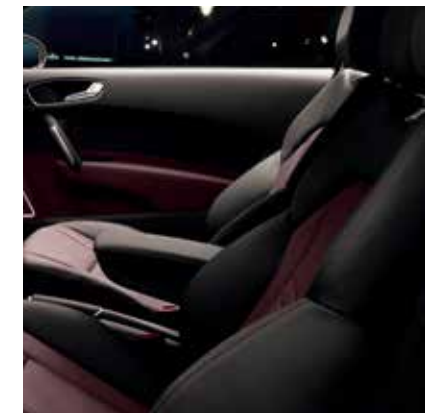

Front centre armrest

Exterior equipment

Make sure your car looks exactly as you want it to by selecting some of our striking options.

Options are subject to availability and may extend delivery.

- = Not available
- = Available
- S = Standard

RRP – Recommended Retail Price.

VAT is calculated at 20% but this may alter to reflect any change in the applicable VAT rate.

Order Code		SE	Sport	S line	S line Style Edition	Black Edition	Basic RRP	Total RRP inc VAT
PAF	Door mirrors – folding. Includes automatic kerb view function, which tilts the passenger mirror downwards towards the kerb when reverse gear is engaged	•	•	•	•	•	£104.17	£125.00
PX4	Xenon Plus headlights. Includes LED daytime-running lights, rear LED lights, automatic headlight adjustment, dynamic range control and headlight washers	-	-	•	S	S	£637.50	£765.00
3FB	Open sky panoramic sunroof. Comprising glass roof with electric slide-and-tilt control and sunshade at front and rear. Also includes convenience closing from outside via the central locking system. Only in combination with LED interior light package. Not available on 1.4 TFSI (122PS) Sport S tronic 119g/km (3-door) or 1.4 TFSI (140PS) Sport 109g/km (Sportback). Only available in combination with 4-seat option (PE6) on A1 Sportback	•	•	•	•	•	£579.17	£695.00
2Z0	Deletion of model and engine technology designation at rear	•	•	•	•	•	No charge	No charge
2Z7	Deletion of engine technology designation at rear	•	•	•	•	•	No charge	No charge
4ZM	Black styling package. Radiator grille-frame in highly polished black, with radiator grille, number plate holder and fog light surrounds in matt black. On S line models the air inlet blade and diffuser insert are in Platinum grey	•	•	•	S	S	£295.83	£355.00



Open sky panoramic sunroof

Exterior equipment

Order Code		SE	Sport	S line	S line Style Edition	Black Edition	Basic RRP	Total RRP inc VAT
4KF	Privacy glass. Dark tinted glass from B pillar backwards	●	●	●	●	S	£241.67	£290.00
1D7	Tow-bar preparation.* Please consult your local Audi Centre for full details on complete tow-bar fitting costs. Only in combination with luggage package. Not available on 1.4 TFSI (185PS) S tronic	●	●	●	●	●	£91.67	£110.00
YNE YNH CP2	Aerodynamic exterior styling package. Includes front spoiler, double-blade roof spoiler, side skirts, rear diffuser in gloss black, stainless steel tailpipe trims and 17" 'S-arm' design alloy wheels	-	●	-	-	-	£1,658.33	£1,990.00
YNH	Double-blade roof spoiler	-	●	-	-	-	£337.50	£405.00

Options are subject to availability and may extend delivery.

- = Not available
- = Available
- S = Standard

*Please note that when ordered in combination with the aerodynamic exterior styling package the rear diffuser is deleted.

RRP – Recommended Retail Price.

VAT is calculated at 20% but this may alter to reflect any change in the applicable VAT rate.



Double-blade roof spoiler



Aerodynamic exterior styling package – rear diffuser and stainless steel tailpipe trims

Safety and security

Intelligent technology designed to give you better all-round awareness and safety on the road.

Order Code		SE	Sport	S line	S line Style Edition	Black Edition	Basic RRP	Total RRP inc VAT
7X1	Acoustic parking system (rear only). Aids parking by acoustically indicating distances to obstacles. Also available as part of the Comfort package – see page 64 for details	●	●	●	●	●	£287.50	£345.00
7X4	Audi parking system plus (front and rear). Aids parking by acoustically and visually indicating distances to obstacles In combination with Comfort package	●	●	●	●	●	£495.83	£595.00
		●	●	●	●	●	£208.33	£250.00
8WB	Front fog lights	●	S	S	S	S	£116.67	£140.00
7K6	Tyre pressure loss indicator. A visual and acoustic warning when the system detects a potential loss of tyre pressure	●	●	●	●	●	£45.83	£55.00
UG4	Audi hill-hold assist. Prevents roll-back on hills for up to 5 seconds by maintaining brake force (standard with S tronic transmission)	●	●	●	●	●	£54.17	£65.00

Options are subject to availability and may extend delivery.

- = Not available
- = Available
- S = Standard

RRP – Recommended Retail Price.

VAT is calculated at 20% but this may alter to reflect any change in the applicable VAT rate.



Acoustic parking system – rear parking sensors



Front fog lights and Audi parking system plus – front parking sensors



Steering wheels

You can choose from a selection of advanced leather multi-function steering wheels, allowing you to control your audio system at the touch of a button.

Options are subject to availability and may extend delivery.

- = Not available
- = Available
- S = Standard

*Leather and stitching (where applicable) can be selected from any of the Audi exclusive colours shown on page 46.

RRP – Recommended Retail Price.

VAT is calculated at 20% but this may alter to reflect any change in the applicable VAT rate.

Order Code		SE	Sport	S line	S line Style Edition	Black Edition	Basic RRP	Total RRP inc VAT
2PV	3-spoke leather Sports steering wheel	•	-	-	-	-	£137.17	£165.00
1XW	3-spoke leather Sports multi-function steering wheel. Only in combination with Driver's Information System	•	S	S	S	S	£266.67	£320.00
YRB S3G	Audi exclusive leather controls package.* Includes leather-covered steering wheel rim, handbrake grip and gear-shift gaiter. Only available in conjunction with 3-spoke leather Sports multi-function steering wheel (1XW) or 3-spoke leather Sports steering wheel (2PV). Not available in combination with Audi exclusive leather-covered steering wheel rim (YRH) or Audi exclusive suede controls package (YUC)	•	•	•	•	•	£512.50	£615.00
YUC S3G	Audi exclusive black suede controls package.* Includes suede-covered steering wheel rim, handbrake grip and gear-shift gaiter. Please note that due to the nature of suede, in time signs of wear may appear. Not available in combination with Audi exclusive leather-covered steering wheel rim (YRH) or Audi exclusive leather controls package (YRB)	•	•	•	•	•	£512.50	£615.00
YRH S3G	Audi exclusive leather-covered steering wheel rim.* Only available in conjunction with 3-spoke leather Sports multi-function steering wheel (1XW) or 3-spoke leather Sports steering wheel (2PV). Not available in conjunction with Audi exclusive leather controls package (YRB) or Audi exclusive suede controls package (YUC)	•	•	•	•	•	£304.17	£365.00



Audi exclusive leather steering wheel rim (YRH) and Audi exclusive extended leather (YSI) in Alabaster white with Crimson red stitching



Audi exclusive leather controls package (YRB) and Audi exclusive extended leather (YSI) in Cognac brown with Magnolia white stitching



Looking after your Audi

When you've chosen your ideal model, it's reassuring to know that it will remain in safe hands. That's why we've created products to protect your Audi, from extended warranties to Audi Complete – our comprehensive service and maintenance package. And there's also a range of Audi accessories and merchandise to choose from, enabling you to further enhance and safeguard your car.





Audi Complete

Audi Complete is a way to look after the servicing and maintenance costs for your Audi in a single package. You pay a one-off or monthly fee and we'll cover all your servicing, maintenance and tyres for the next three years, including your first MOT. It means you only have to pay for fuel, insurance and your Road Fund Licence. So you can be reassured that your car will be maintained by trained Audi Technicians, using genuine Audi parts. You can also opt for our Service and Maintenance packages if you prefer.

Service Plan

Choosing an Audi Service Plan provides an easy way to cover all your car's scheduled servicing with a one-off payment. It can take care of everything from fluid and filter changes to your full service, ensuring you retain a full Audi service history. There are no servicing bills to plan for and you'll continue to benefit from today's prices for the length of your agreement.

**For further details on Service Schedules please see page 82.

Options are subject to availability and may extend delivery. A1 Service Plans are not available in the Channel Islands.

- = Not available
• = Available
S = Standard

RRP – Recommended Retail Price.

VAT is calculated at 20% but this may alter to reflect any change in the applicable VAT rate.

Order Code		A1	A1 Sportback	Basic RRP	Total RRP inc VAT
-	Audi Complete – Service and Maintenance. Comprehensive care for your Audi covering all your servicing and maintenance for 3 years, as well as your first MOT. Visit your local Audi Centre for further information or audi.co.uk/audicomplete for full details including terms and conditions	•	•	£17.50	£21.00*
-	Audi Complete – Service, Maintenance and Tyres. Comprehensive care for your Audi covering all your servicing, maintenance and tyres for 3 years, as well as your first MOT. Visit your local Audi Centre for further information or audi.co.uk/audicomplete for full details including terms and conditions	•	•	£23.33	£28.00*

*Retail customers only. Pricing based on 3 years/30,000 miles (whichever occurs sooner). All pricing is a 'starting from' price for the Audi A1 model range and is therefore subject to change and mileage/model dependent.

Order Code		A1	A1 Sportback	Basic RRP	Total RRP inc VAT
-	Audi Service Plan – LongLife Service Schedule.** Comprehensive package covering servicing costs for 5 years or 50,000 miles, whichever comes sooner. Your A1 should be placed on the LongLife Service Schedule if you drive over 10,000 miles per annum. Visit audi.co.uk or your local Audi Centre for full details, including terms, conditions and exclusions. For retail customers only	•	•	£208.33	£250.00
-	Audi Service Plan – Fixed Inspection Service Schedule.** Comprehensive package covering servicing costs for 5 years or 50,000 miles, whichever comes sooner. Your A1 should be placed on the Fixed Inspection Service Schedule if you drive under 10,000 miles per annum. Visit audi.co.uk or your local Audi Centre for full details, including terms and conditions. For retail customers only	•	•	£375.00	£450.00

Warranty

All new Audi models now come with a choice of a three, four or five-year warranty.* What's more, if you decide to sell your Audi before the warranty expires, it will be fully transferred to the new owner. So, whichever length of warranty you choose, you can forget about unexpected repair bills and enjoy several years of carefree driving.

*Three-year warranty consists of a two-year unlimited mileage warranty and a third-year warranty with a 60,000 mile limitation. Four-year warranty consists of two-year unlimited mileage coverage, and two further years' coverage with a 75,000 mile limitation. Five-year warranty consists of two-year unlimited mileage coverage, and three further years' coverage with a 90,000 mile limitation.

**Only available prior to registration of your Audi A1. Please contact your Audi Centre for full details.

Options are subject to availability and may extend delivery.

- = Not available
● = Available
S = Standard

RRP - Recommended Retail Price.

VAT is calculated at 20% but this may alter to reflect any change in the applicable VAT rate.

Order Code		A1	Basic RRP	Total RRP inc VAT
-	Audi Warranty , covering you for unlimited mileage in the first 2 years of ownership, and up to 60,000 miles in the third year. Transferable between owners**	S	No charge	No charge
EA6	Audi Warranty , covering you for up to 4 years or 75,000 miles, whichever comes soonest. Cover includes a 2-year unlimited mileage warranty, and up to 75,000 miles in the third and fourth years. Transferable between owners**	●	£195.83	£235.00
EA9	Audi Warranty , covering you for up to 5 years or 90,000 miles, whichever comes soonest. Cover includes a 2-year unlimited mileage warranty, and up to 90,000 miles in the third, fourth and fifth years. Transferable between owners**	●	£416.67	£500.00

Accessories

Choosing an Audi isn't just a matter of deciding on the model you want; it's about creating a car that suits your needs perfectly. And that's why we've developed a whole range of accessories to enhance your A1, enabling you to customise it down to the last detail. Like your Audi, all these accessories are developed to the highest possible standard and they're all available exclusively from Audi. To find out more, just visit your local Audi Centre.

Warranty

All of the accessories available on the A1 are covered by a three-year warranty* if they are ordered and included in the purchase price of the car at date of delivery. Any accessories ordered and installed after delivery include a two-year warranty.*

*Excluding Road Angel products.

Audi Accessories warranty terms and conditions can be found at audi.co.uk



Merchandise

From the enthusiasts' motorsport collection to the sophisticated Audi collection, there's a wide variety of adults' and children's clothing, lifestyle accessories and collectables, all of which bear the Audi name.

Please speak to a member of our team at your local Audi Centre to see the full Audi collection and to place an order. A selection of Audi merchandise is also available to buy from audi.co.uk/merchandise.



Audi Difference

The experts in Vorsprung durch Technik

Our Audi Approved Master Technicians have undergone an impressive 100,000 hours of training over a 10-year programme to ensure they have the latest technical expertise for maintaining and servicing your Audi. All our Service Advisors undergo a specialist induction and training to ensure they are Audi professionals and able to talk to you about any issues you may have with your Audi vehicle.

Servicing tailored to your needs

Regular servicing is key to safeguarding your Audi's performance and a full Audi service history could help you enhance the future re-sale value. To make servicing easy, the Audi Service Schedules have been designed to work with your individual driving style and vehicle.

We offer two different schedules: the fixed Inspection Service and the variable LongLife Service schedule. The conventional fixed Inspection Service schedule has fixed intervals for the Oil-change Service and Inspection Service, which are determined by time and distance.

With the variable LongLife Service schedule, the Inspection Service intervals are also fixed but the Oil-change Service intervals are variable. Sensors take account of driving style and conditions to determine when the Oil-change Service is required and the driver is informed via the on-board service interval display.

The choice of Service Schedule will depend on journey type and mileage as well as individual driving style and conditions. The table to the right can be used for guidance but your Audi Centre will help you to determine the most suitable Service schedule for you based on your individual circumstances and preferences.

Fixed Inspection Service Schedule

	Vehicle usage:
Mileage	Less than 10,000 miles per annum Mainly city/town centre driving. Short journeys.
	Service Intervals:
Oil-change Service	Fixed to every 9,000+ miles/1 year
Inspection Service	Fixed to every 19,000+ miles/2 years

Variable LongLife Service Schedule

	Vehicle usage:
Mileage	More than 10,000 miles per annum Motorway and main road driving. Mainly longer distance journeys. Constant speeds.
	Service Intervals:
Oil-change Service	Variable to a maximum of every 19,000+ miles/2 years
Inspection Service	Fixed to every 19,000+ miles/2 years

When a vehicle is frequently used in the following conditions, we recommend a Fixed Inspection Service Schedule, regardless of mileage:

Uneconomical driving styles, e.g. heavy acceleration and braking, constant use of high revs

High engine-loading conditions, e.g. frequent towing and hill climbs

*As indicated by the service interval display. Mileages are approximate as the Service Indicator system uses kilometres as its distance measurement.

Your convenience comes first

At Audi you can choose from a range of convenient services that suit your needs. Why not book a 'service while you wait' appointment* and enjoy our complimentary refreshments while your car is with us? Or, if you need to be mobile, take advantage of one of our courtesy cars which we can even deliver to you.* We guarantee we can service your Audi within 5 days without a courtesy car or within 10 days if you need transport. We will also ensure your car is returned to you with a full valet.

Audi Genuine Parts

You can rest assured that only Audi Genuine Parts will be used on your vehicle. What's more, Audi parts and labour come with a 2-year guarantee.**

No hidden costs

We believe strongly in transparency when it comes to our prices. For added peace of mind, we will give you a quotation over the phone for the work you have requested and email you the price confirmation. We'll consult you if any additional work on your car is needed when it is with us. We won't carry out any extra work without asking your permission first.

All part of the service

Whenever we see an Audi for a service, we connect it directly to our headquarters in Ingolstadt which enables us to check your car's software and make sure it's as up-to-date as possible. If the factory has released a software upgrade for your model, it can be applied immediately - improving anything from your car's efficiency to the precision of its parking system.

Audi Roadside Assistance

Your new car comes complete with 3 years' complimentary roadside assistance and recovery across the UK, provided by RAC Motoring Services. Also included is roadside assistance throughout Europe, managed by RAC Motoring Services.

For further information and terms and conditions please visit audi.co.uk.

* Subject to availability.

**Excludes wear and tear.



A1

technical data

Engine	Petrol							Diesel	
	1.2 TFSI	1.4 TFSI	1.4 TFSI Sport	1.4 TFSI S line	1.4 TFSI*	1.4 TFSI*	1.4 TFSI S line	1.6 TDI	2.0 TDI
Transmission	5-speed manual	6-speed manual	7-speed S tronic	7-speed S tronic	6-speed manual	7-speed S tronic	7-speed S tronic	5-speed manual	6-speed manual
Cylinder	4-cylinder	4-cylinder	4-cylinder	4-cylinder	4-cylinder	4-cylinder	4-cylinder	4-cylinder	4-cylinder
Displacement, cubic cm	1197	1390	1390	1390	1395	1395	1390	1598	1968
Max. power ¹ , PS at rpm	86/4800	122/5000	122/5000	122/5000	140/5000	140/5000	185/6200	105/4400	143/4200
Max. torque, Nm at rpm	160/1500-3500	200/1500-4000	200/1500-4000	200 /1500-4000	250/1500-3500	250/1500-3500	250/2000-4500	250/1500-2500	320/1750-2500
Top speed ² , mph	112	126	126	126	132	132	141	118	135
0-62mph acceleration, seconds	11.7	8.9	8.9	8.9	7.9	7.9	6.9	10.5	8.2
CO ₂ emissions ³ , g/km	118	124	119	122	109	109	139	99	108
Benefit in kind (BIK)%	15%	16%	15%	16%	13%	13%	19%	14%	16%
Fuel consumption ³ , mpg (l/100km) Urban	45.6 (6.2)	41.5 (6.8)	43.5 (6.5)	43.5 (6.5)	48.7 (5.8)	49.6 (5.7)	37.7 (7.5)	64.2 (4.4)	56.5 (5.0)
Fuel consumption ³ , mpg (l/100km) Extra Urban	64.2 (4.4)	64.2 (4.4)	64.2 (4.4)	61.4 (4.6)	68.9 (4.1)	68.9 (4.1)	55.4 (5.1)	83.1 (3.4)	78.5 (3.6)
Fuel consumption ³ , mpg (l/100km) Combined	55.4 (5.1)	53.3 (5.3)	54.3 (5.2)	53.3 (5.3)	60.1 (4.7)	60.1 (4.7)	47.9 (5.9)	74.3 (3.8)	68.9 (4.1)
ABI insurance group 1-50 ⁴	9 E	15 E	15 E	16 E	22 E	22 E	28 E	14 E	21 E
Unladen weight ⁴ , kg	1040	1100	1125	1125	1110	1120	1190	1140	1190
Gross weight limit, kg	1490	1550	1575	1575	1560	1570	1640	1590	1640
Roof load limit/nose weight, kg	75/50	75/50	75/50	75/50	75/50	75/50	75/50	75/50	75/50
Max trailer load unbraked ⁵ , kg	550	580	600	600	590	590	630	600	630
Max trailer load with 12% gradient ⁵ , kg	1000	1200	1200	1200	1200	1200	1200	1200	1200
Max trailer load with 8% gradient ⁵ , kg	1200	1200	1200	1200	1200	1200	1200	1200	1200
Luggage compartment capacity, rear seats upright, litres**	270	270	270	270	270	270	270	270	270
Luggage compartment capacity, rear seats folded, litres**	920	920	920	920	920	920	920	920	920
Fuel tank capacity approx, litres	45	45	45	45	45	45	45	45	45
Emission standard	EUS	EUS	EUS	EUS	EUS	EUS	EUS	EUS	EUS

*1.4 TFSI engine with Audi cylinder-on-demand technology.

**Please note that luggage capacity is reduced when a BOSE® surround sound system or Technology package is fitted.

⁴Highest insurance group rating shown. Group may be lower dependent on trim level. Please visit www.thatcham.org/abigrouprating for details.

Please note: The maximum power output figures are quoted in PS (or Pferdestärke, which is the metric equivalent of brake horsepower). To convert to brake horsepower, divide the PS figure by 1.0139.

⁵The given value was obtained in accordance with the specified measurement procedure (the respective current version of the Directive 80/1269/EEC).

²Top speed is achieved in top gear.

³Fuel consumption and CO₂ emissions figures are obtained under standardised test conditions (Directive 93/116/EEC) using a representative model. This allows direct comparison between different models from different manufacturers, but may not represent the actual fuel consumption achieved in 'real world' driving conditions. More information is available at www.vca.gov.uk.

⁴Vehicle's unladen weight without driver (calculated in accordance with the current version of Directive 80/1268/EEC). The fitting of additional equipment may increase the vehicle's unladen weight and drag coefficient, whereupon the potential carrying capacity and top speed will be correspondingly reduced.

⁵The engine's power output always goes down with increasing altitude. At 1,000m above sea level, and for every additional 1,000m, deduct 10% from the weight of the outfit (trailer load limit + gross weight of the towing vehicle).

A1 Sportback Petrol technical data

*1.4 TFSI engine with Audi cylinder-on-demand technology.

**Please note that luggage capacity is reduced when a BOSE® surround sound system or Technology package is fitted.

†Highest insurance group rating shown. Group may be lower dependent on trim level. Please visit www.thatcham.org/abigrouprating for details.

Please note: The maximum power output figures are quoted in PS (or Pferdestärke, which is the metric equivalent of brake horsepower). To convert to brake horsepower, divide the PS figure by 1.0139.

‡The given value was obtained in accordance with the specified measurement procedure (the respective current version of the Directive 80/1269/EEC).

§Top speed is achieved in top gear.

¶Fuel consumption and CO₂ emissions figures are obtained under standardised test conditions (Directive 93/116/EEC) using a representative model. This allows direct comparison between different models from different manufacturers, but may not represent the actual fuel consumption achieved in 'real world' driving conditions. More information is available at www.vca.gov.uk.

‡‡Vehicle's unladen weight without driver (calculated in accordance with the current version of Directive 80/1268/EEC). The fitting of additional equipment may increase the vehicle's unladen weight and drag coefficient, whereupon the potential carrying capacity and top speed will be correspondingly reduced.

‡‡‡The engine's power output always goes down with increasing altitude. At 1,000m above sea level, and for every additional 1,000m, deduct 10% from the weight of the outfit (trailer load limit + gross weight of the towing vehicle).

Engine	1.2 TFSI	1.4 TFSI	1.4 TFSI	1.4 TFSI Sport*	1.4 TFSI*	1.4 TFSI S line
Transmission	5-speed manual	6-speed manual	7-speed S tronic	7-speed S tronic	7-speed S tronic	7-speed S tronic
Cylinder	4-cylinder	4-cylinder	4-cylinder	4-cylinder	4-cylinder	4-cylinder
Displacement, cubic cm	1197	1390	1390	1395	1395	1390
Max. power [†] , PS at rpm	86/4800	122/5000	122/5000	140/5000	140/5000	185/6200
Max. torque, Nm at rpm	160/1500-3500	200/1500-4000	200 /1500-4000	250/1500-3500	250/1500-3500	250/2000-4500
Top speed [‡] , mph	112	126	126	132	132	141
0-62mph acceleration, seconds	11.9	9.0	9.0	8.0	8.0	7.0
CO ₂ emissions [¶] , g/km	118	126	122	109	113	139
Benefit in kind (BIK)%	15%	17%	16%	13%	14%	19%
Fuel consumption [¶] , mpg (l/100km) Urban	45.6 (6.2)	40.9 (6.9)	43.5 (6.5)	49.6 (5.7)	47.9 (5.9)	37.7 (7.5)
Fuel consumption [¶] , mpg (l/100km) Extra Urban	64.2 (4.4)	61.4 (4.6)	61.4 (4.6)	68.9 (4.1)	65.7 (4.3)	55.4 (5.1)
Fuel consumption [¶] , mpg (l/100km) Combined	55.4 (5.1)	52.3 (5.4)	53.3 (5.3)	60.1 (4.7)	57.6 (4.9)	47.9 (5.9)
ABI insurance group 1-50 [†]	9 E	16 E	16 E	22 E	22 E	29 E
Unladen weight ^{‡‡} , kg	1065	1125	1150	1145	1145	1215
Gross weight limit, kg	1555	1615	1640	1635	1635	1685
Roof load limit/nose weight, kg	75/50	75/50	75/50	75/50	75/50	75/50
Max trailer load unbraked [§] , kg	570	600	610	610	610	640
Max trailer load with 12% gradient [§] , kg	1000	1200	1200	1200	1200	1200
Max trailer load with 8% gradient [§] , kg	1200	1200	1200	1200	1200	1200
Luggage compartment capacity, rear seats upright, litres**	270	270	270	270	270	270
Luggage compartment capacity, rear seats folded, litres**	920	920	920	920	920	920
Fuel tank capacity approx, litres	45	45	45	45	45	45
Emission standard	EU5	EU5	EU5	EU5	EU5	EU5

A1 Sportback Diesel technical data

*Please note that luggage capacity is reduced when a BOSE® surround sound system or Technology package is fitted.

[†]Highest insurance group rating shown. Group may be lower dependent on trim level. Please visit www.thatcham.org/abigrouprating for details.

Please note: The maximum power output figures are quoted in PS (or Pferdestärke, which is the metric equivalent of brake horsepower). To convert to brake horsepower, divide the PS figure by 1.0139.

[‡]The given value was obtained in accordance with the specified measurement procedure (the respective current version of the Directive 80/1269/EEC).

[§]Top speed is achieved in top gear.

[¶]Fuel consumption and CO₂ emissions figures are obtained under standardised test conditions (Directive 93/116/EEC) using a representative model. This allows direct comparison between different models from different manufacturers, but may not represent the actual fuel consumption achieved in 'real world' driving conditions. More information is available at www.vca.gov.uk.

^{||}Vehicle's unladen weight without driver (calculated in accordance with the current version of Directive 80/1268/EEC). The fitting of additional equipment may increase the vehicle's unladen weight and drag coefficient, whereupon the potential carrying capacity and top speed will be correspondingly reduced.

^{|||}The engine's power output always goes down with increasing altitude. At 1,000m above sea level, and for every additional 1,000m, deduct 10% from the weight of the outfit (trailer load limit + gross weight of the towing vehicle).

Engine	1.6 TDI	2.0 TDI
Transmission	5-speed manual	6-speed manual
Cylinder	4-cylinder	4-cylinder
Displacement, cubic cm	1598	1968
Max. power [†] , PS at rpm	105/4400	143/4200
Max. torque, Nm at rpm	250/1500-2500	320/1750-2500
Top speed [‡] , mph	118	135
0-62mph acceleration, seconds	10.7	8.3
CO ₂ emissions [§] , g/km	99	108
Benefit in kind (BIK)%	14%	16%
Fuel consumption [¶] , mpg (l/100km) Urban	64.2 (4.4)	56.5 (5.0)
Fuel consumption [¶] , mpg (l/100km) Extra Urban	83.1 (3.4)	78.5 (3.6)
Fuel consumption [¶] , mpg (l/100km) Combined	74.3 (3.8)	68.9 (4.1)
ABI insurance group 1-50 ^{††}	15 E	22 E
Unladen weight , kg	1165	1215
Gross weight limit, kg	1655	1685
Roof load limit/nose weight, kg	75/50	75/50
Max trailer load unbraked ^{§§} , kg	620	640
Max trailer load with 12% gradient ^{§§} , kg	1200	1200
Max trailer load with 8% gradient ^{§§} , kg	1200	1200
Luggage compartment capacity, rear seats upright, litres*	270	270
Luggage compartment capacity, rear seats folded, litres*	920	920
Fuel tank capacity approx, litres	45	45
Emission standard	EU5	EU5



A1 dimensions

The technical drawings opposite show the exact dimensions of the A1, so you can check everything – from whether the car will fit in your garage to whether your luggage will fit in the boot.

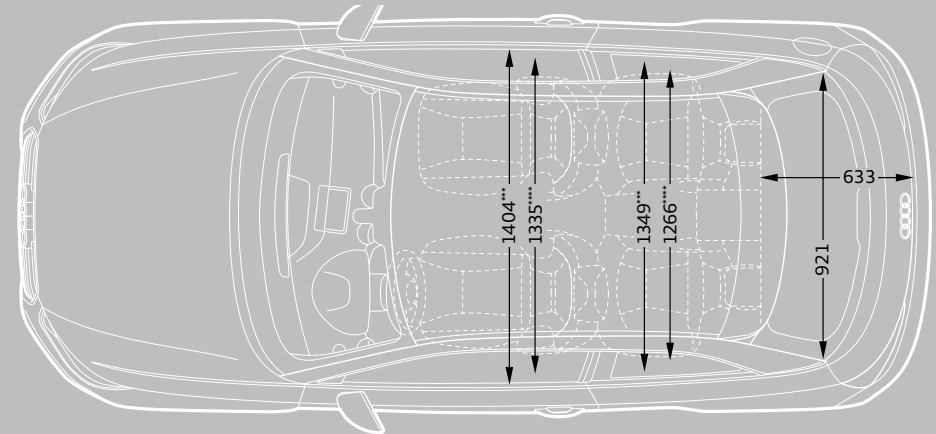
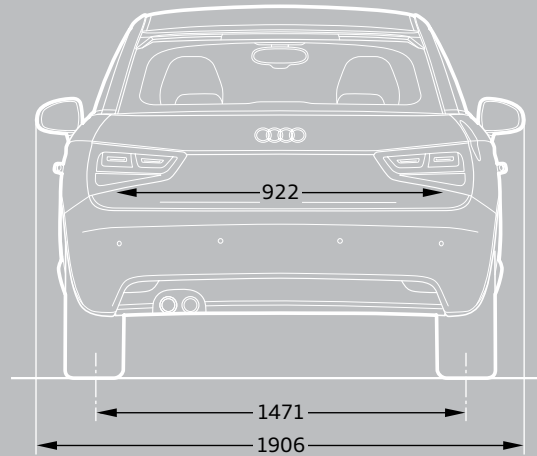
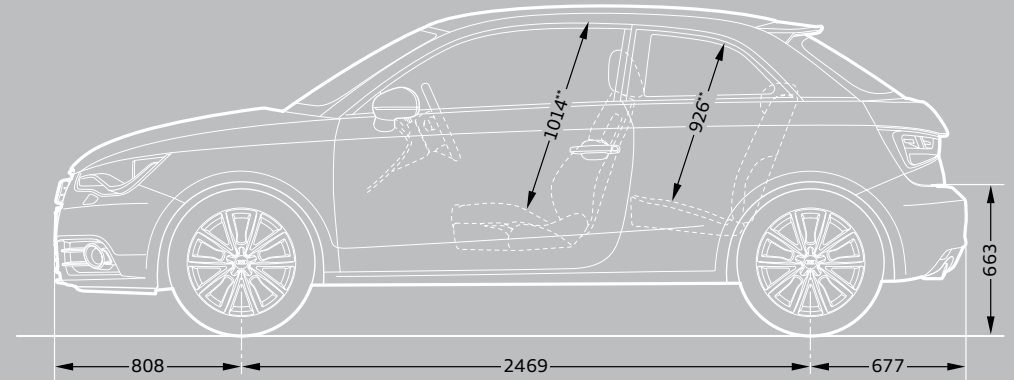
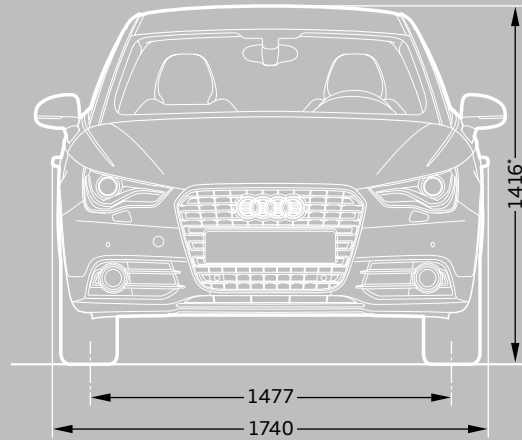

Dimensions were measured with vehicle at unladen weight.

Turning circle approx 10.7m.

Dimensions in millimetres.

*Including roof aerial, the vehicle height is 1,441mm

**Maximum headroom

***Elbow room width

****Shoulder room width

A1 Sportback dimensions

The technical drawings opposite show the exact dimensions of the A1 Sportback, so you can check everything – from whether the car will fit in your garage to whether your luggage will fit in the boot.

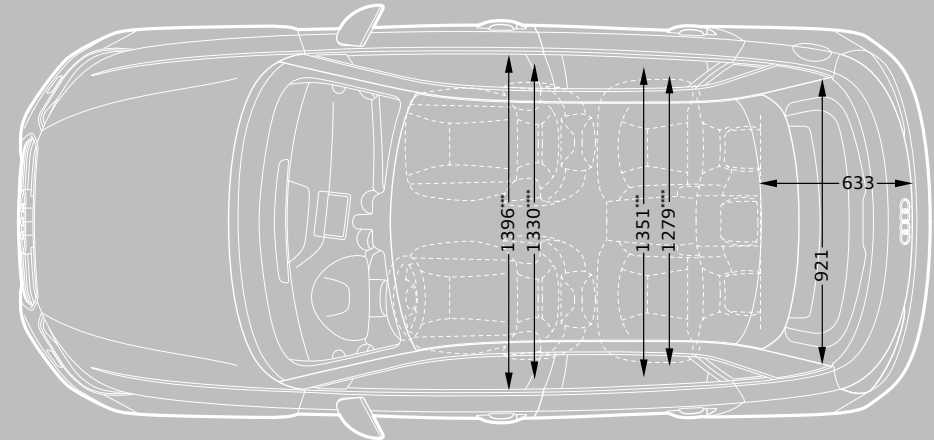
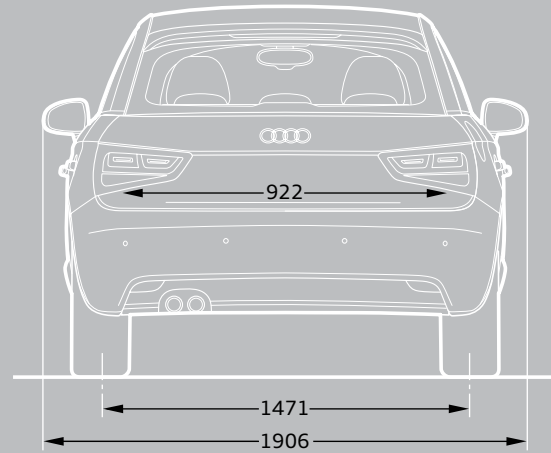
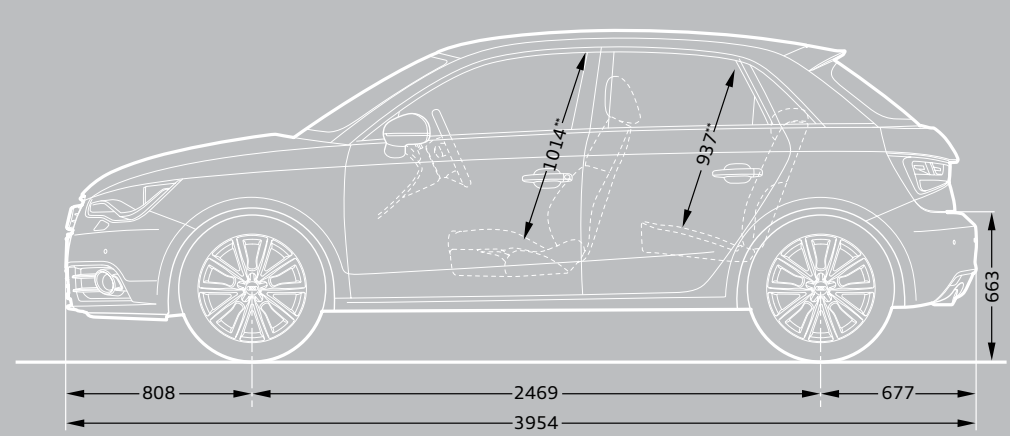
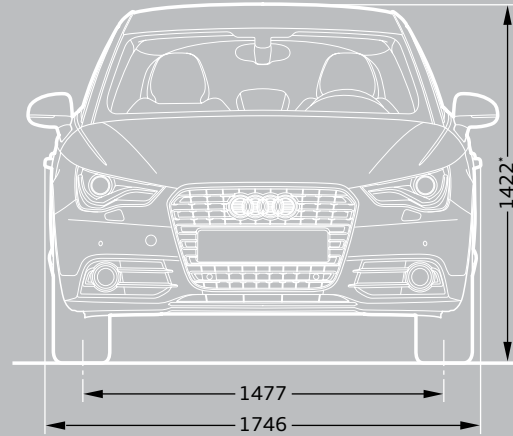

Dimensions were measured with vehicle at unladen weight.

Turning circle approx 10.7m.

Dimensions in millimetres.

*Including roof aerial, the vehicle height is 1,438mm

**Maximum headroom

***Elbow room width

****Shoulder room width

Pricing and Additional information

Welcome to Audi

By placing an order for your Audi, you're choosing to get behind the wheel of one of the most sophisticated cars on the road. And because we believe the service we offer should be just as advanced, we want to let you know exactly what you can expect from us, now and in the future.

We've agreed a set of standards with all our Centres which governs the way we do business with you. It outlines the kind of service we promise to deliver for every customer, right down to filling each new Audi we sell with half a tank of fuel.

So whether you're interested in the date your car will arrive in the UK or the way we'll dispose of non-biodegradable materials after we service your Audi, you can have total confidence in us.

Audi Promise

Audi Centres

We guarantee that all our Centres will be open as follows:

Sales: Monday to Friday 9am–6pm
Saturday 9am–5pm

Service: Monday to Friday 8am–6pm
Saturday 8.30am–1pm

Sunday opening is at local discretion.

New car delivery

Once we've confirmed a delivery date for your car, we'll keep you informed of progress. Subject to reasonable notice, we'll then deliver it to a place of your choice, whether that's your home or work. In the unlikely event of a delay, we'll provide a courtesy car to minimise inconvenience and keep you mobile.

Environmental commitment

We promise to dispose of all non-biodegradable materials from your vehicle in a responsible manner.

Pricing

Prices and specifications given are correct at the time of printing. Always check details with your Audi Centre as Audi policies are continually developing. We reserve the right to change prices or specifications at any time.

All prices are subject to VAT, currently charged at 20%, but this may alter to reflect any change in the applicable VAT rate.

Delivery charges and number plates are not included in the vehicle price.

Delivery charge	£471.66
Number plate	£20.00
VAT	£98.34
Total	£590.00

Audi Customer Care

Every new Audi benefits from the comprehensive Audi Customer Care Package, which comprises:

- ▶ A 3-year Audi warranty, which covers you for unlimited mileage in the first 2 years of ownership, with a full mechanical and electrical warranty which covers you for up to 60,000 miles in the 3rd year
- ▶ A 3-year paint warranty
- ▶ A 12-year anti-corrosion warranty
- ▶ 3 years' UK roadside assistance and recovery

You also have the option when ordering your new car of choosing a 4-year or 5-year Audi warranty. Speak to a member of the sales team for more information.

Audi tax-free sales

If you are entitled to purchase a vehicle free of VAT, normally through military or diplomatic privilege, please contact your local Audi Centre for full details.

Should you have any difficulty obtaining the information you require, please call 01908 548 356.

Audi Finance

Audi Finance specialises in providing funding solutions for Audi drivers. Whether your Audi is for private or business use, there is a range of funding options to choose from.

Below is the full range of finance products, which comprises:

- ▶ Solutions – a Personal Contract Plan
- ▶ Hire purchase
- ▶ Lease purchase
- ▶ Finance lease
- ▶ Contract hire

With all products, you can choose a fixed-cost maintenance plan designed to help you budget accurately.

No matter which Audi model you choose, your local Audi Centre can provide you with a personalised quote designed to fit your budget and motoring needs.

Audi Finance is a trading name of Volkswagen Financial Services (UK) Limited. An offer of finance depends on certain conditions. Available to people over 18 in the UK only.

Audi Insurance

We want you to start enjoying your new car from day one and thanks to Audi Insurance complimentary 7-day cover, you can. Call free on 0800 316 7893 (lines are open Monday to Friday 8am–9pm, and Saturday 9am–5pm), provide a few details and a cover note will be sent to your Audi Centre. They will then tax your car and you can drive it away.

Additional information

CO₂ data and information

CO₂ emissions-based Vehicle Excise Duty

Vehicle Excise Duty (Road Fund Licence) is based upon the amount of Carbon Dioxide (CO₂) a vehicle emits, measured in grams per kilometre (g/km). First year VED rates apply to the first year of ownership. Annual VED rates apply thereafter. The DVLA has created thirteen categories:

Petrol and Diesel engines	First year	Annual rate (second year onwards)
A – up to 100g/km	£0.00	£0.00
B – 101 to 110g/km	£0.00	£20.00
C – 111 to 120g/km	£0.00	£30.00
D – 121 to 130g/km	£0.00	£105.00
E – 131 to 140g/km	£125.00	£125.00
F – 141 to 150g/km	£140.00	£140.00
G – 151 to 165g/km	£175.00	£175.00
H – 166 to 175g/km	£285.00	£200.00
I – 176 to 185g/km	£335.00	£220.00
J – 186 to 200g/km	£475.00	£260.00
K – 201 to 225g/km	£620.00	£280.00
L – 226 to 255g/km	£840.00	£475.00
M – over 255g/km	£1,065.00	£490.00

Vehicle Excise Duty (VED) rates correct at time of going to print, but these may alter to reflect any change in the applicable VED rate.

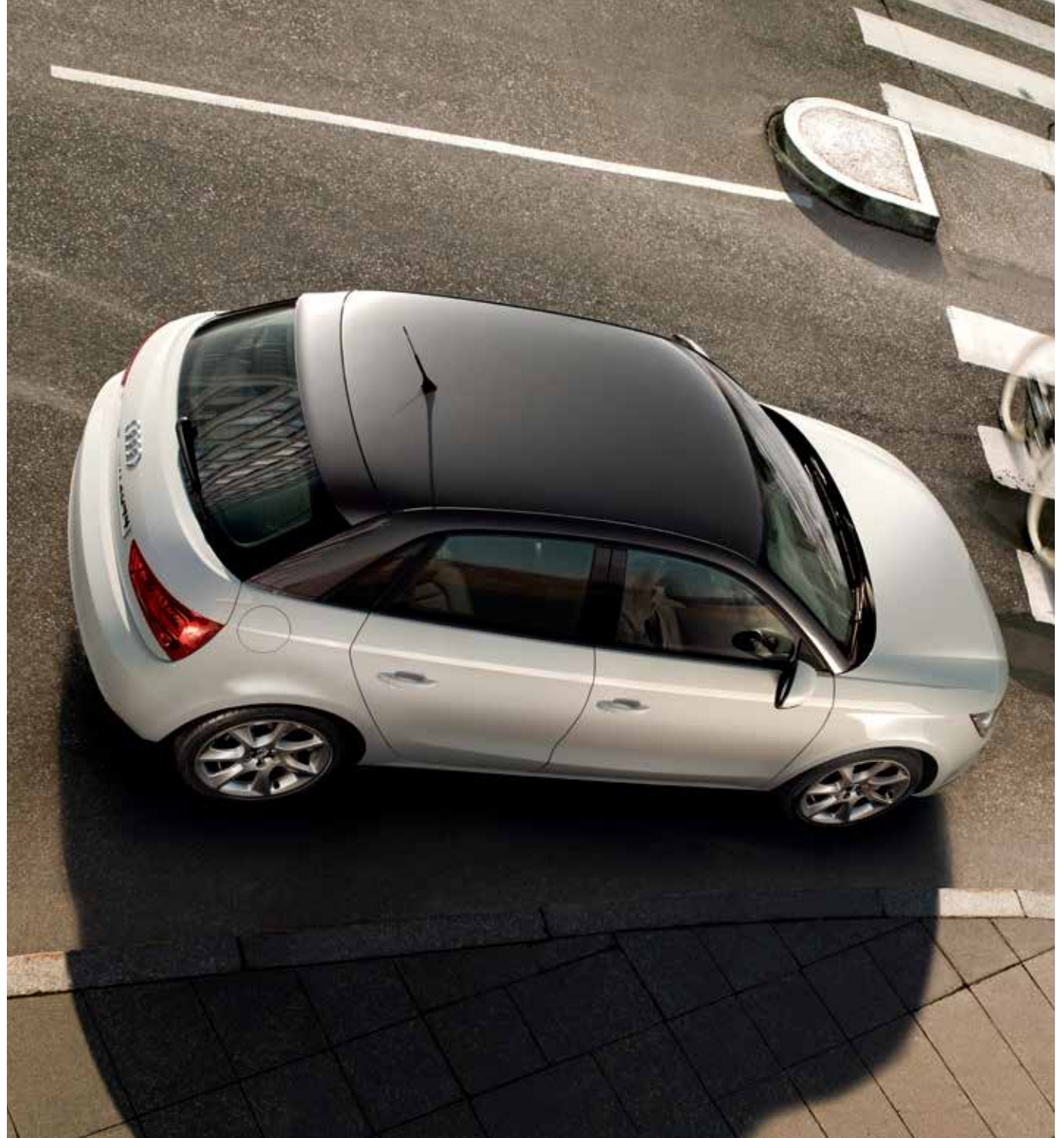

Audi UK

Customer Services
Selectapost 29
Sheffield
S97 3FG
0800 699888
audi.co.uk

Specifications and prices subject
to change without notice.

© Audi (UK)

Printed in the UK
Edition 4.0 08/13
2014 Model Year

Images are for illustrative purposes only. Models shown are left-hand drive.