



The Audi A5 and S5 Coupé
Pricing and Specification Guide
Valid from March 2013

Personalising your Audi A5 Coupé

This guide has been designed to help you tailor and price your Audi A5 Coupé quickly and logically. At the back, you will find information on CO2 emissions-based taxation and the other services offered by Audi, including Finance and Insurance. You can also configure your Audi A5 Coupé online at audi.co.uk.

The Audi A5 Coupé

Engines	12
Transmissions	13
Efficiency	14
quattro®	16

Model details and prices

SE model equipment	20
S line model equipment	22
Black Edition model equipment	24
S5 Coupé model equipment	26
S5 Coupé Black Edition model equipment	28
Model prices	30

Audi exclusive	32
-----------------------	----

Colour and upholstery

Paint	36
Upholstery and seats	36
Colour and trim guide	52

Inlays	56
---------------	----

Options

Wheels, tyres and suspension	60
Packages	66
Audio and communication	68
Interior equipment	70
Exterior equipment	72
Safety and security	73
Steering wheels	74

Looking after your Audi

Audi Complete and warranty	78
Accessories	79
Merchandise	80
Audi Difference	81

Technical details

Technical data	82
Dimensions	85
Pricing and Additional information	87





Vorsprung durch Technik

Three words that express the very essence of Audi. Vorsprung durch Technik isn't a slogan. It's our way of seeing the world. It is the driving force behind our history of innovation that continues into the 21st century. Indeed, many technologies that Audi pioneered remain in our cars today. Some are milestones in the history of the motorcar.

From our beginnings in 1899, to the Auto Union team's Grand Prix successes in the 1930s and our more recent wins at Le Mans, we have always been at the forefront of the motor industry.

Vorsprung durch Technik makes us who we are. To see more of its influence, just read on.





The Audi A5 Coupé – a combination of style and power

Exceptional design is something you'll find everywhere in the Audi A5 Coupé – from the beautiful lines of the exterior to the highly efficient fuel-injection technology within. An aerodynamic shape, muscular wheel arches and low-profile alloy wheels give this car a very special blend of style and performance, which is only emphasised by the choice of dynamic engines and transmissions available.

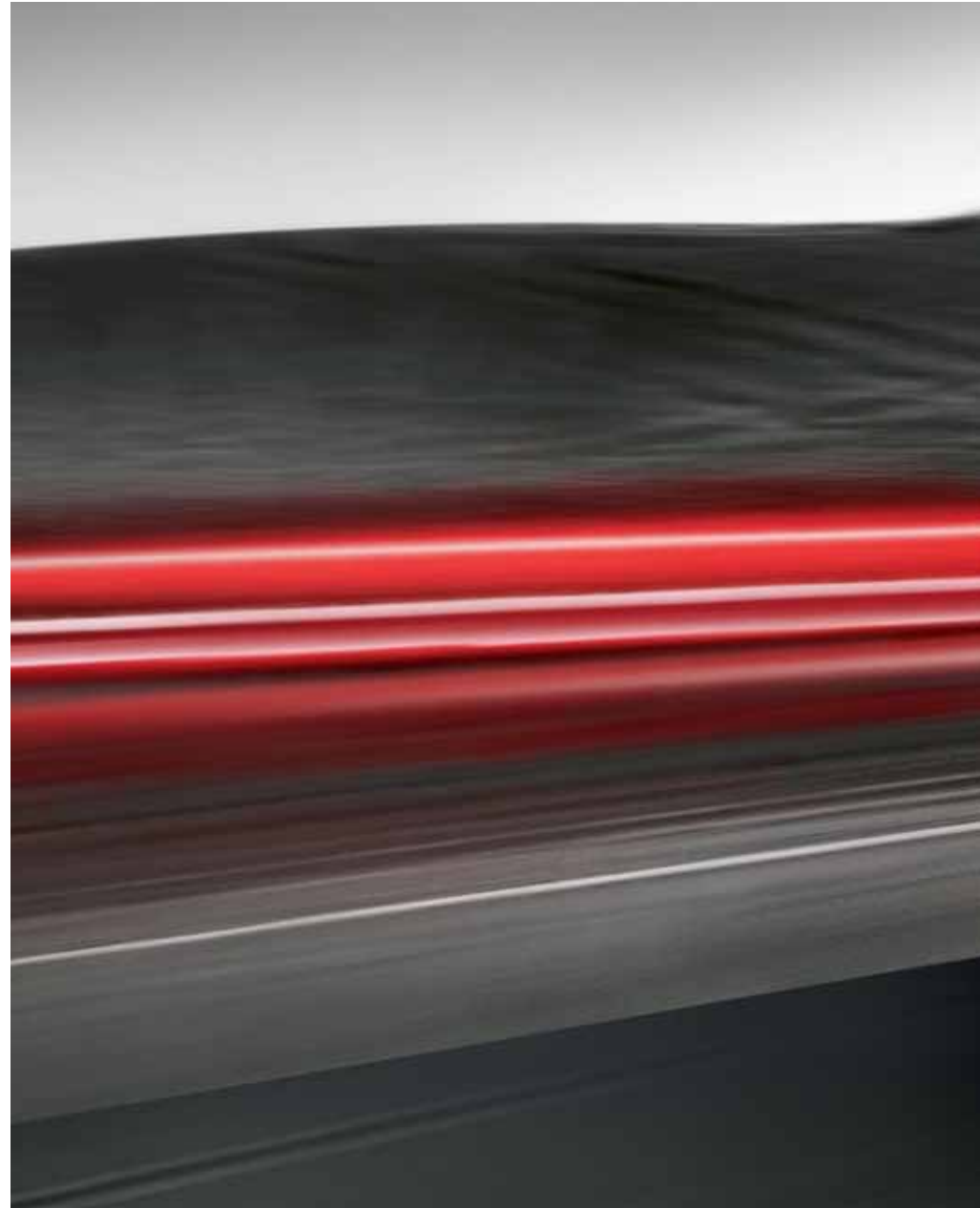







A5 Coupé interior story

We've introduced a number of finishing touches to the Audi A5 Coupé interior to make your driving experience both comfortable and unique. You'll find an impressive attention to detail in everything from the Driver's Information System with energy-saving tips, to the luxurious leather seating, which means that every journey you make will be a personal one.

Engines

Petrol

TFSI® direct-injection technology is a unique Audi innovation that includes supercharging, which combines FSI® technology with forced induction – giving cars an extra injection of power and torque. It also delivers enhanced fuel efficiency as precisely the right amount of fuel and air are injected into the combustion chambers, enabling the engine to ‘breathe’ more easily. It results in reduced heat loss and increased output, with around a 15% reduction in fuel consumption and significantly lower exhaust emissions.

Diesel

We introduced TDI® to the roads in 1989, and since then, we’ve continuously refined it, including developing common-rail technology. Under this system, a series of piezo injectors use electrical charge to precisely control the amount of fuel injected into the engine. As well as reducing noise, this allows combustion to happen at a lower temperature, with less oxygen, which lowers emissions.





Transmissions

multitronic®

Translating a driver's preferences and intentions into road performance, the multitronic® transmission system entertains no compromises – whether in terms of dynamism, convenience or economy. multitronic® automatic transmission is available on models without quattro® permanent all-wheel-drive.

A continuously variable transmission, multitronic® can transmit up to 400 Nm of torque and permits an exceptionally wide range of gear ratios. The result is smooth, powerful acceleration and a high level of driving comfort. And thanks to its lightweight design and a number of advanced electronic control systems that monitor gradient, road conditions and the way the driver is using the accelerator pedal, multitronic® also plays an instrumental role in reducing fuel consumption.

S tronic®

Driving is all about thinking ahead, which is just what the S tronic® dual-clutch transmission does. It works almost as two separate systems, one engaging the odd-numbered and the other the even-numbered gears. So when you're accelerating in second, it has third gear waiting for you. And once you make the switch, it's already thinking about fourth. With two clutches working together, you can change gears almost instantly while experiencing smooth, uninterrupted power.

Efficiency

At Audi, doing less is something we're trying to do more of. We're working to use less fuel, release less CO₂ and waste less energy. It's why we've incorporated a number of more efficient technologies into the Audi A5 Coupé.

Automatic Start-Stop function

In heavy traffic, your car still uses fuel and releases CO₂, even when it's stationary. The automatic Start-Stop function counteracts this problem by switching off the engine when your car comes to a standstill. As soon as you touch the clutch, the car restarts. In conjunction with TDI® and TFSI®, it helps save up to 0.4 litres of fuel every 100km.

TDI® and TFSI®

Inside the engine of the Audi A5 Coupé you'll find the same advanced fuel-injection technology that's driven us to win after win at Le Mans. With TDI® and TFSI®, fuel is injected directly into the engine's chambers so that combustion is timed right down to the millisecond. As a result, waste is minimised and you get the most from every last drop of fuel.





Recuperation

When a vehicle brakes, the discs convert the kinetic energy into thermal energy, which is wasted as it cannot be used. With a recuperation system like the one in the Audi A5 Coupé, the kinetic energy is converted into useful electrical energy. The way it works is simple. While the car is coasting or braking, the alternator voltage is raised above the level of the basic electrical system, which enables the alternator to generate electrical energy and store it temporarily in the battery. When the vehicle accelerates, this energy is used to relieve the load on the alternator, resulting in a fuel saving of up to 3%.

quattro®

It's the technology that has given Audi the edge on the rally circuit ever since it was first introduced over 30 years ago – a technology that delivers ultimate control whilst enhancing the sporty characteristics which make the Audi A5 Coupé so thrilling to drive. It's called quattro® permanent all-wheel-drive. The principle is simple: in the same way that four brakes ensure better deceleration, four permanently-driven wheels deliver better acceleration and road-holding, pushing or pulling the car as needed, for a driving experience that's both dynamic and safe.

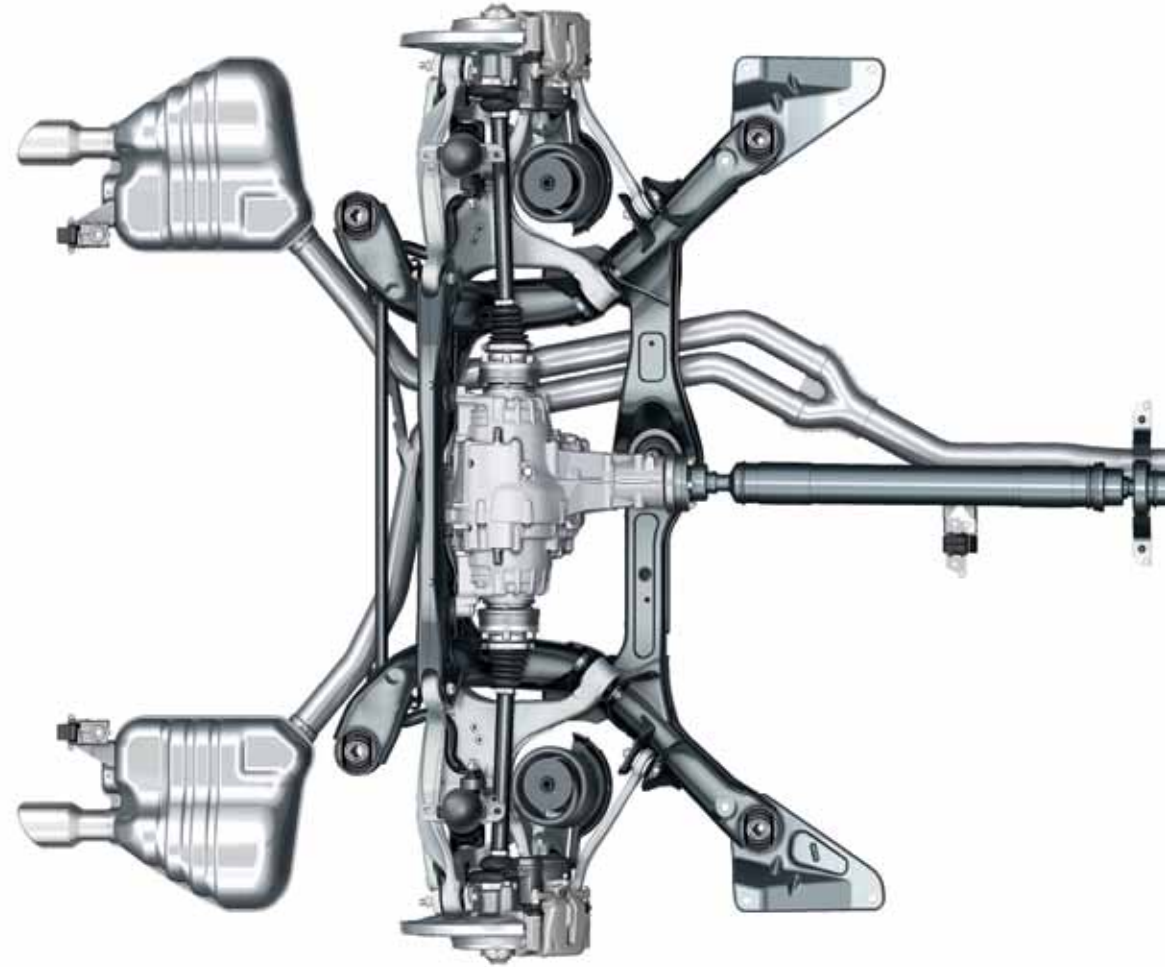

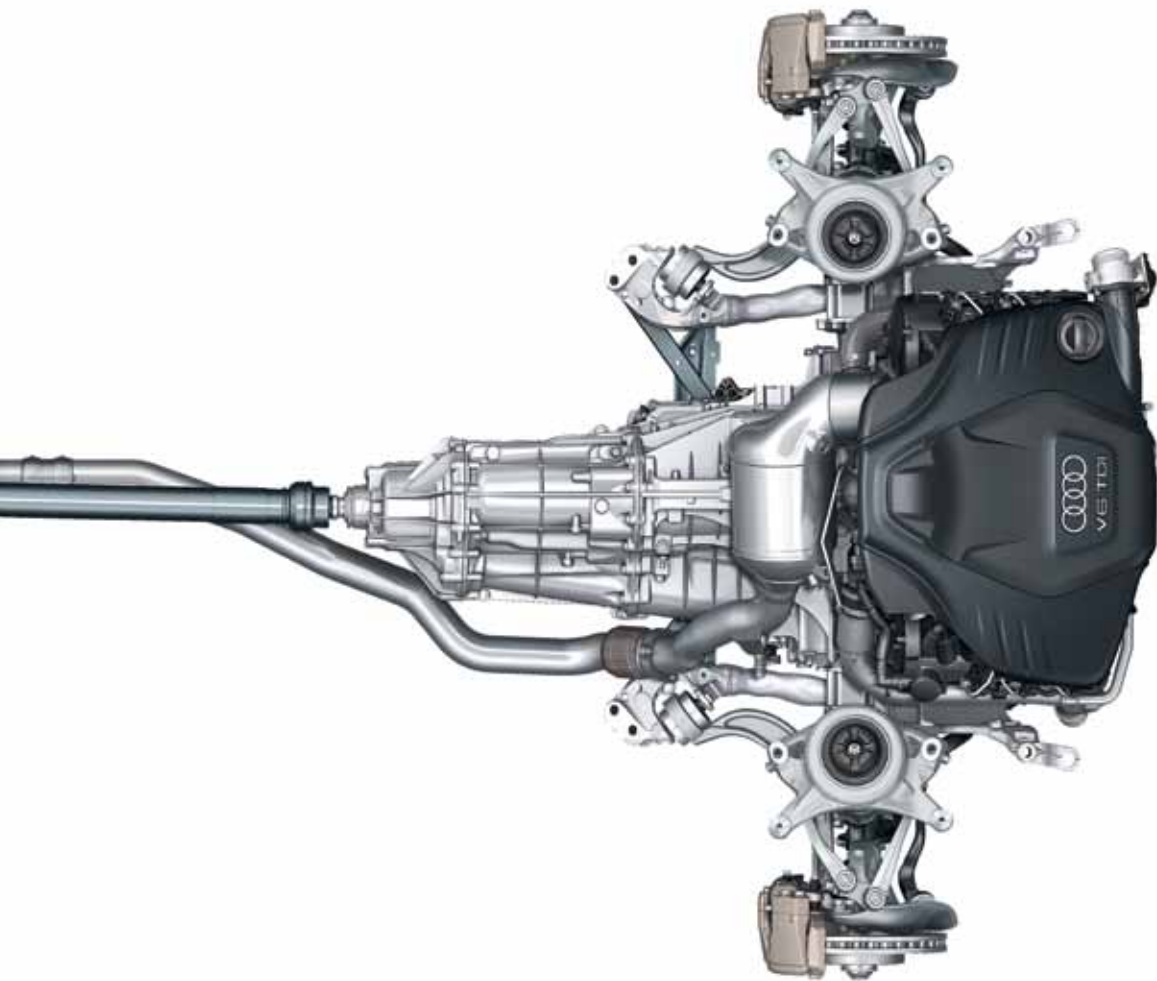

In the Audi A5 Coupé, asymmetric dynamic torque distribution continuously distributes drive power between the front and rear axles, depending on weather conditions, road surface and gradient. This leads to greater flexibility and an enhanced, sportier drive.

quattro® with Sports differential

The optional electronically regulated Sports differential distributes variable amounts of drive force to each rear wheel, ensuring outstanding acceleration performance in corners and stabilising the vehicle's response to load change. It also brings better direct steering characteristics and, as it requires less steering effort, more agile handling.





SE model equipment

All A5 Coupé models have the following items of standard equipment

Engine

Automatic Start-Stop function for greater fuel and CO₂ efficiency

Recuperation for optimal energy utilisation

Misfuelling inhibition for diesel engines

Diesel particulate filter (DPF) for diesel engines

Wheels, tyres and suspension

17" x 7.5J '5-arm' design alloy wheels with 225/50 R17 tyres. TDIe model features low rolling resistance tyres

Space-saver spare wheel (excluding 2.0 TDIe 163PS)

Tyre repair kit (2.0 TDIe 163PS only)

Audio and communication

Audi Concert radio which includes:

- Single CD drive and SDHC memory card reader which are both MP3, WMA and AAC compatible
- 6.5" colour centre display with MMI operating logic
- AUX-IN connection
- TP memo – automatically saves traffic news when driving

Audi sound system speaker package with 10 speakers including subwoofer (180 Watts)

Mobile phone preparation – Bluetooth interface

Safety and security

Electronic Stability Programme (ESP) including electronic limited-slip differential on front wheel-drive models

First-aid kit

Front and rear fog lights

Front and rear ISOFIX preparation with front passenger airbag de-activation switch

Full size airbags for driver and passenger

Front side airbags

Head-level side airbags front and rear

Halogen headlights with electric headlight range control and daytime-running lights

Light and rain sensor – automatically switches the dipped beam headlights and windscreen wipers on/off depending on the light and rain conditions. Also includes coming-home/leaving-home function which delays the deactivation of the front and rear lights after locking and automatically activates the lights when unlocking

Rear parking sensors – facilitate parking by acoustically indicating the distance to obstacles; measurement is by ultrasonic sensors integrated discreetly into the bumper

Rest recommendation system – analyses driving behaviour based on steering, pedals and gear lever movements. If the system detects a change in driving patterns it can, via audio and visual effects, notify the driver of the possible need to take a rest

Thatcham category 1 alarm and immobiliser

Toolkit and car jack (2.0 TDIe 163PS contains toolkit only)

Warning triangle

Interior equipment

3-spoke leather multi-function steering wheel (paddle shift for automatic models)

Cup holder in centre console

Driver's Information System (DIS) in colour with energy-saving tips and rest recommendations. Shows the radio station or track title, telephone control, menu and other display information from the infotainment system such as navigation (if fitted). Also includes an on-board trip computer with short and long-term trip memory, outside temperature display, digital speedometer and door or boot-open warning



Deluxe 3-zone climate control with separate air distribution and digital display for the driver and front passenger. System includes air-conditioning controls in rear centre console for passenger compartment

Electric front windows

Electromechanical parking brake includes parking brake function when stationary, drive off assistance with automatic release when pulling away and emergency braking assist, acting on all 4 wheels while driving

Electromechanical power steering

Front and rear floor mats

Front centre armrest including two 12V power sockets

Intelligent key

Interior chrome package

Reflex finish inlays Steel grey for grey or black interiors, Moor brown for beige interiors

Steering column adjustment for rake and reach

Exterior equipment

Auto-opening boot lid

Exterior mirrors – electrically operated and heated

Exhaust pipes – 4-cylinder models have two exhaust pipes on the left-hand side, 6-cylinder models have one exhaust pipe on either side

Exterior aluminium package

Front grille in high gloss black

Seats

Milano leather upholstery

Split-folding rear seat



Image shows the A5 Coupé SE model with optional Ice silver, metallic paint (P5) and adaptive headlights (PX1, 8Q5)

S line model equipment

In addition to SE model equipment

Basic RRP

£1,583.33

Total RRP inc VAT

£1,900.00

Wheels, tyres and suspension

18" x 8J '5-spoke' S line design alloy wheels with 245/40 R18 tyres

Sports suspension with stiffer spring settings and shock absorbers, 20mm lower than standard suspension (S line Sports suspension available at no charge)

Interior equipment

3-spoke S line multi-function steering wheel (paddle shift for automatic models)

Black headlining

Matt-brushed aluminium inlays

Perforated leather gear knob

S line sill plates

Seats

Front Sports seats with electric lumbar support

Fine Nappa Leather upholstery with S line embossing

Exterior equipment

Chrome rolled exhaust

Rear LED lights

S line exterior styling package

including:

- S line side skirts
- S line bumper
- S line rear diffuser
- S line badges on wings

Xenon Plus headlights with LED daytime running lights



18" x 8J '5-spoke' S line design alloy wheels



3-spoke S line multi-function steering wheel



Xenon Plus headlights



Rear LED lights



Black Edition model equipment

In addition to S line
model equipment

Basic RRP

£1,041.47

Total RRP inc VAT

£1,250.00*

Wheels, tyres and suspension

19" x 9J '5-arm Rotor' design titanium finish alloy wheels with 255/35 R19 tyres

Audio and communication

Audi Music Interface, connection for use with stereo audio sources, USB and MP3 devices including Apple iPod generation 4 onwards and Apple iPhone

Bang & Olufsen sound system, 14 high-performance speakers and two amplifiers which create 505 Watts of stunning surround sound, balanced to suit the specific acoustic properties of the car's interior

DAB digital radio, receives programmes from digital radio transmitters, in addition to the range of analogue stations, with better sound quality

Interior equipment

3-spoke flat-bottom multi-function steering wheel (paddle shift for automatic models)

Piano finish black inlays

Exterior equipment

Black styling package – radiator grille-frame in highly polished black, with radiator grille and number plate holder in matt black

Privacy glass – dark tinted from B pillar backwards



19" x 9J '5-arm Rotor' design titanium finish alloy wheels



Bang & Olufsen sound system



Piano finish black inlays



3-spoke flat-bottom multi-function steering wheel





S5 Coupé quattro model equipment – in addition to SE model equipment

Wheels, tyres and suspension

19" x 8.5J '5-parallel-spoke' design alloy wheels with 255/35 R19 tyres

'S' Sports suspension

Safety and security

'S' model enhanced braking system

Interior equipment

3-spoke 'S' Sports multi-function leather steering wheel with paddle shift and contrasting stitching

Aluminium scuff plates with S5 logo

Black headlining

Interior lighting package – includes front and rear footwell lighting, active door reflectors, illuminated vanity mirrors, rear reading lights, entrance lights and illuminated glove compartment, vents and internal door controls

Inlays in matt-brushed aluminium

'S' instrument dials

Seats

Fine Nappa leather upholstery

Leather door armrests

S5 Coupé Super Sports seats with electric adjustment and lumbar support

Exterior equipment

Aluminium-effect door mirror housings

Exhaust pipes – twin on left and right-hand side in chrome rolled finish

'S' radiator grille with S5 logo

Painted brake callipers with S5 logo

'S' body styling

Xenon headlights with LED daytime running lights and LED rear lamps



19" x 8.5J '5-parallel-spoke' design alloy wheels



'S' instrument dials





Black Edition

**S5 Coupé quattro
Black Edition
model equipment –
in addition to S5
model equipment**

Basic RRP
£1,041.47

Total RRP inc VAT
£1,250.00*

Wheels, tyres and suspension

19" x 9J '5-arm Rotor' design titanium finish alloy wheels with 255/35 R19 tyres

Audio and communication

Audi Music Interface – connection for use with stereo audio sources, USB and MP3 devices including Apple iPod generation 4 onwards and Apple iPhone

Bang & Olufsen sound system, 14 high-performance speakers and two amplifiers which create 505 Watts of stunning surround sound, balanced to suit the specific acoustic properties of the car's interior

DAB digital radio, receives programmes from digital radio transmitters, in addition to the range of analogue stations, with better sound quality

Interior equipment

3-spoke flat-bottom multi-function steering wheel (paddle shift for automatic models)

Piano finish black inlays

Exterior equipment

Black styling package – radiator grille-frame in highly polished black, with radiator grille and number plate holder in matt black

Privacy glass – dark tinted from B pillar backwards



19" x 9J '5-arm Rotor' design titanium finish alloy wheels



Bang & Olufsen sound system



A5 Coupé SE

Engines	Power	Transmissions	CO ₂ g/km	Basic RRP	Total RRP inc VAT	Recommended OTR
1.8 TFSI	170PS	6-speed manual	134	£23,250.00	£27,900.00	£28,665.00
1.8 TFSI	170PS	multitronic	134	£24,483.33	£29,380.00	£30,145.00
2.0 TFSI quattro	211PS	6-speed manual	159	£26,937.50	£32,325.00	£33,140.00
2.0 TFSI quattro	211PS	7-speed S tronic	159	£28,170.83	£33,805.00	£34,620.00
2.0 TDIe	163PS	6-speed manual	115	£25,250.00	£30,300.00	£30,945.00
2.0 TDI	177PS	6-speed manual	120	£25,250.00	£30,300.00	£30,945.00
2.0 TDI quattro	177PS	6-speed manual	134	£26,520.83	£31,825.00	£32,590.00
2.0 TDI	177PS	multitronic	123	£26,483.33	£31,780.00	£32,425.00
2.0 TDI quattro	177PS	7-speed S tronic	139	£27,754.17	£33,305.00	£34,070.00

A5 Coupé S line

Engines	Power	Transmissions	CO ₂ g/km	Basic RRP	Total RRP inc VAT	Recommended OTR
1.8 TFSI	170PS	6-speed manual	134	£24,833.33	£29,800.00	£30,565.00
1.8 TFSI	170PS	multitronic	134	£26,066.67	£31,280.00	£32,045.00
2.0 TFSI quattro	211PS	6-speed manual	159	£28,520.83	£34,225.00	£35,040.00
2.0 TFSI quattro	211PS	7-speed S tronic	159	£29,754.17	£35,705.00	£36,520.00
2.0 TDI	177PS	6-speed manual	120	£26,833.33	£32,200.00	£32,845.00
2.0 TDI quattro	177PS	6-speed manual	134	£28,104.17	£33,725.00	£34,490.00
2.0 TDI	177PS	multitronic	123	£28,066.67	£33,680.00	£34,325.00
2.0 TDI quattro	177PS	7-speed S tronic	139	£29,337.50	£35,205.00	£35,970.00
3.0 TDI	204PS	multitronic	129	£29,833.33	£35,800.00	£36,445.00
3.0 TDI quattro	245PS	7-speed S tronic	149	£32,650.00	£39,180.00	£39,960.00

A5 Coupé Black Edition

Engines	Power	Transmissions	CO ₂ g/km	Basic RRP	Total RRP inc VAT	Recommended OTR
1.8 TFSI	170PS	6-speed manual	134	£25,875.00	£31,050.00	£31,815.00
1.8 TFSI	170PS	multitronic	134	£27,108.33	£32,530.00	£33,295.00
2.0 TFSI quattro	211PS	6-speed manual	159	£29,562.50	£35,475.00	£36,290.00
2.0 TFSI quattro	211PS	7-speed S tronic	159	£30,795.83	£36,955.00	£37,770.00
2.0 TDI	177PS	6-speed manual	120	£27,875.00	£33,450.00	£34,095.00
2.0 TDI quattro	177PS	6-speed manual	134	£29,145.83	£34,975.00	£35,740.00
2.0 TDI	177PS	multitronic	123	£29,108.33	£34,930.00	£35,575.00
2.0 TDI quattro	177PS	7-speed S tronic	139	£30,379.17	£36,455.00	£37,220.00
3.0 TDI	204PS	multitronic	129	£30,875.00	£37,050.00	£37,695.00
3.0 TDI quattro	245PS	7-speed S tronic	149	£33,691.67	£40,430.00	£41,210.00

Please note: The maximum power output figures are quoted in PS (or Pferdestärke, which is the metric equivalent of brake horsepower). To convert to brake horsepower, divide the PS figure by 1.0139.

Recommended On-The-Road (OTR) retail prices include: delivery charge, half a tank of fuel, number plates at £590.00 (inc. VAT), Road Fund Licence (which may vary depending on model/transmission – see page 88 for details) and first registration fee at £55.00. Vehicle Excise Duty correct at time of going to print, but this may alter to reflect any change in the applicable VED rate.

RRP – Recommended Retail Price. VAT is calculated at 20% but this may alter to reflect any change in the applicable VAT rate.

S5 Coupé

Engine	Power	Transmission	CO ₂ g/km	Basic RRP	Total RRP inc VAT	Recommended OTR
3.0 TFSI	333PS	7-speed S tronic	190	£35,083.33	£42,100.00	£43,205.00

S5 Coupé Black Edition

Engine	Power	Transmission	CO ₂ g/km	Basic RRP	Total RRP inc VAT	Recommended OTR
3.0 TFSI	333PS	7-speed S tronic	190	£36,125.00	£43,350.00	£44,455.00

Please note: The maximum power output figures are quoted in PS (or Pferdestärke, which is the metric equivalent of brake horsepower). To convert to brake horsepower, divide the PS figure by 1.0139.

Recommended On-The-Road (OTR) retail prices include: delivery charge, half a tank of fuel, number plates at £590.00 (inc. VAT), Road Fund Licence (which may vary depending on model/transmission – see page 88 for details) and first registration fee at £55.00. Vehicle Excise Duty correct at time of going to print, but this may alter to reflect any change in the applicable VED rate.

RRP – Recommended Retail Price. VAT is calculated at 20% but this may alter to reflect any change in the applicable VAT rate.





Audi exclusive

Every Audi is intrinsically exclusive. It's the breathtaking design, the exceptional engineering, the Vorsprung durch Technik. But for that special touch you can specify your new A5 Coupé with options from Audi exclusive. Whether you want a unique, custom-mixed paint colour or seats in a combination of complementary shades, Audi exclusive will enable you to drive the car you've always imagined.

Both the exclusive and standard options can be found on the following pages.





Audi exclusive line

There are a number of ways to customise your car's interior with the Audi exclusive range. And if you'd like us to help you choose, we've put the most popular elements of the range together into one harmonious package – the Audi exclusive line.

With experience over more than 20 years, our expert designers understand which elements work well together. From high-quality Fine Nappa leather seats to Audi exclusive door sill trims, every detail has been chosen to truly enhance your drive.

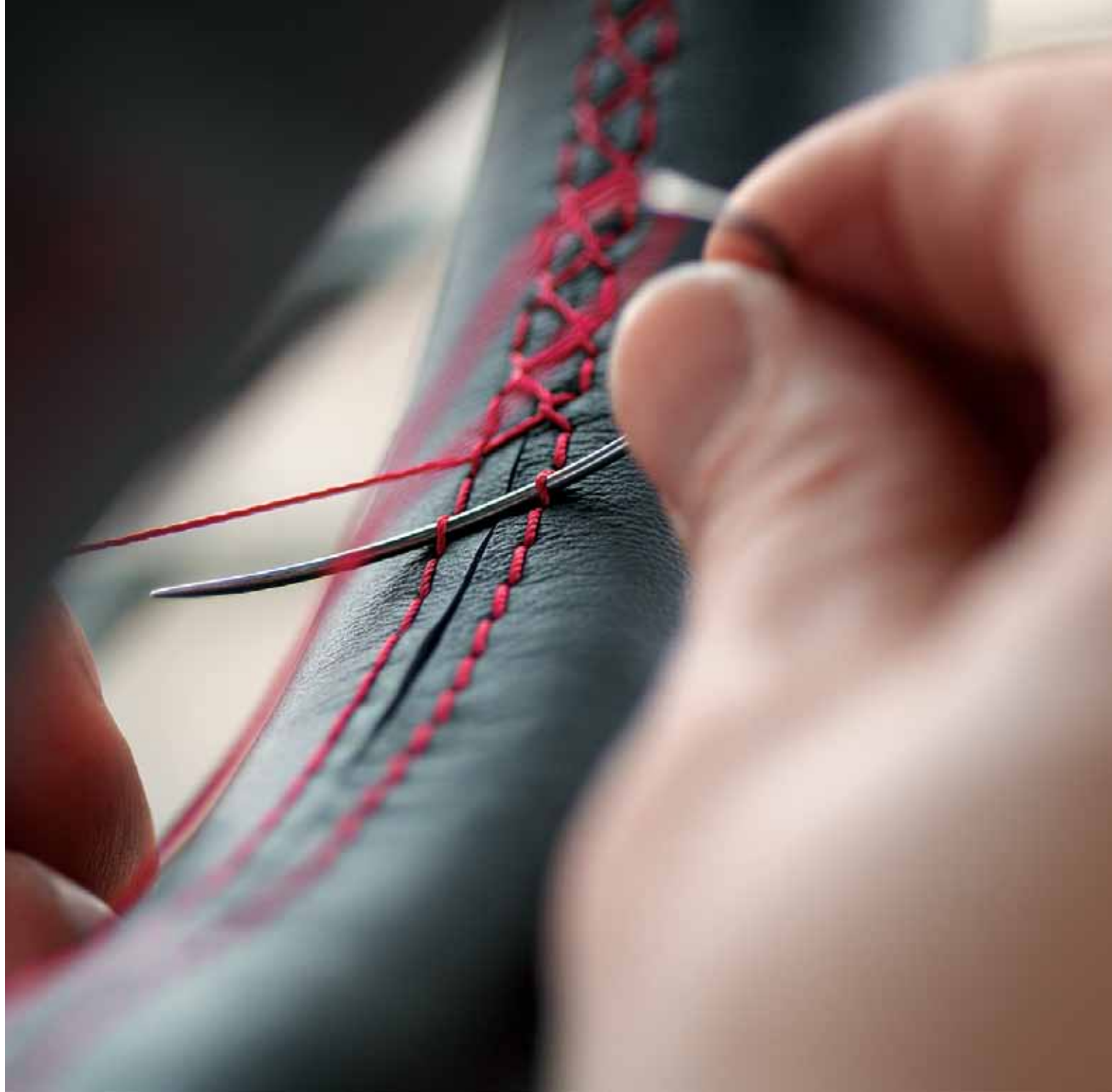

Paint choices

We believe that every part of your car should have a personal touch. Which is why you can choose from a wide range of paint colours and finishes, from standard shades to metallic and pearl effects. We can even mix a customised colour for you to create the perfect fit.

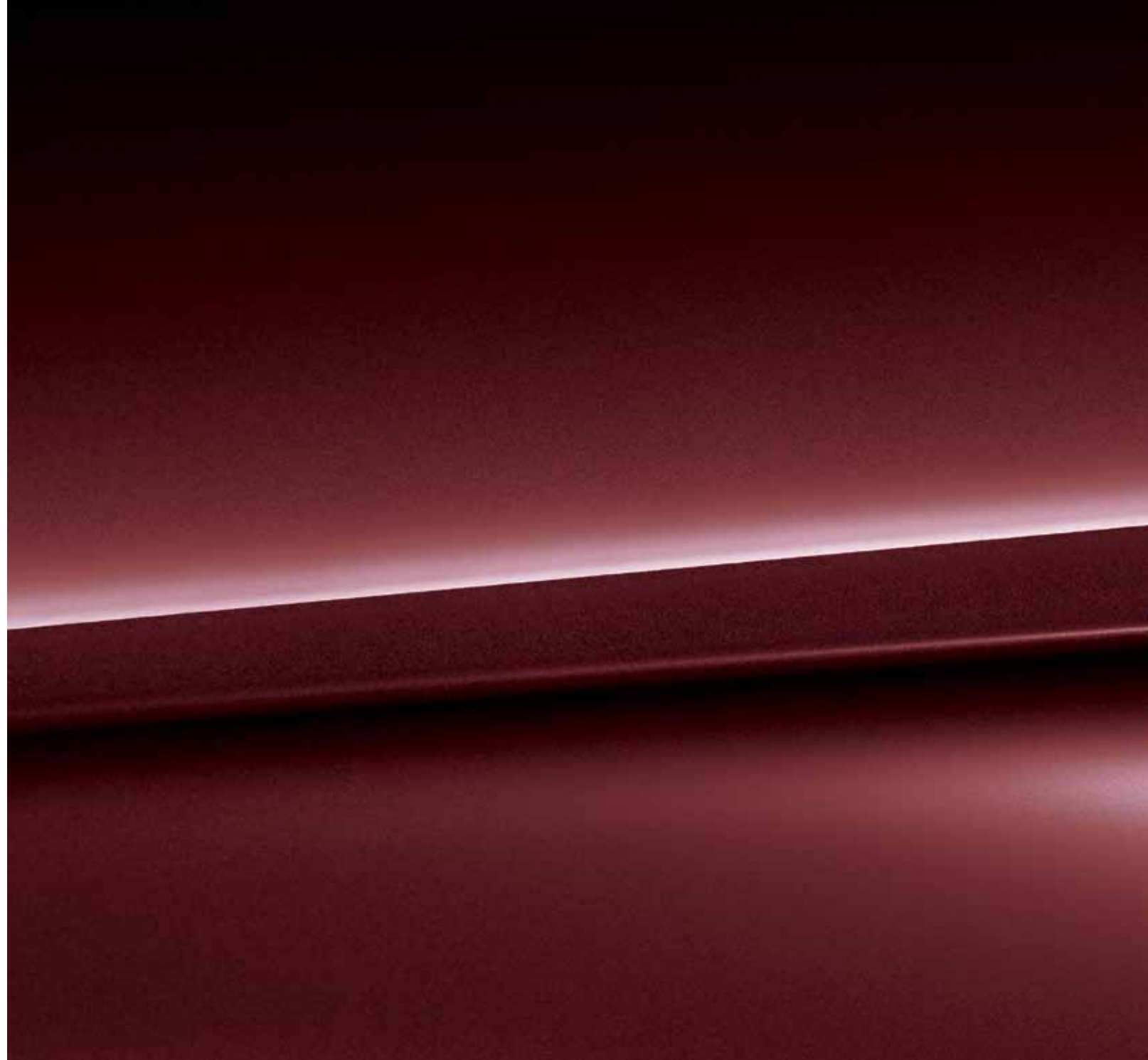

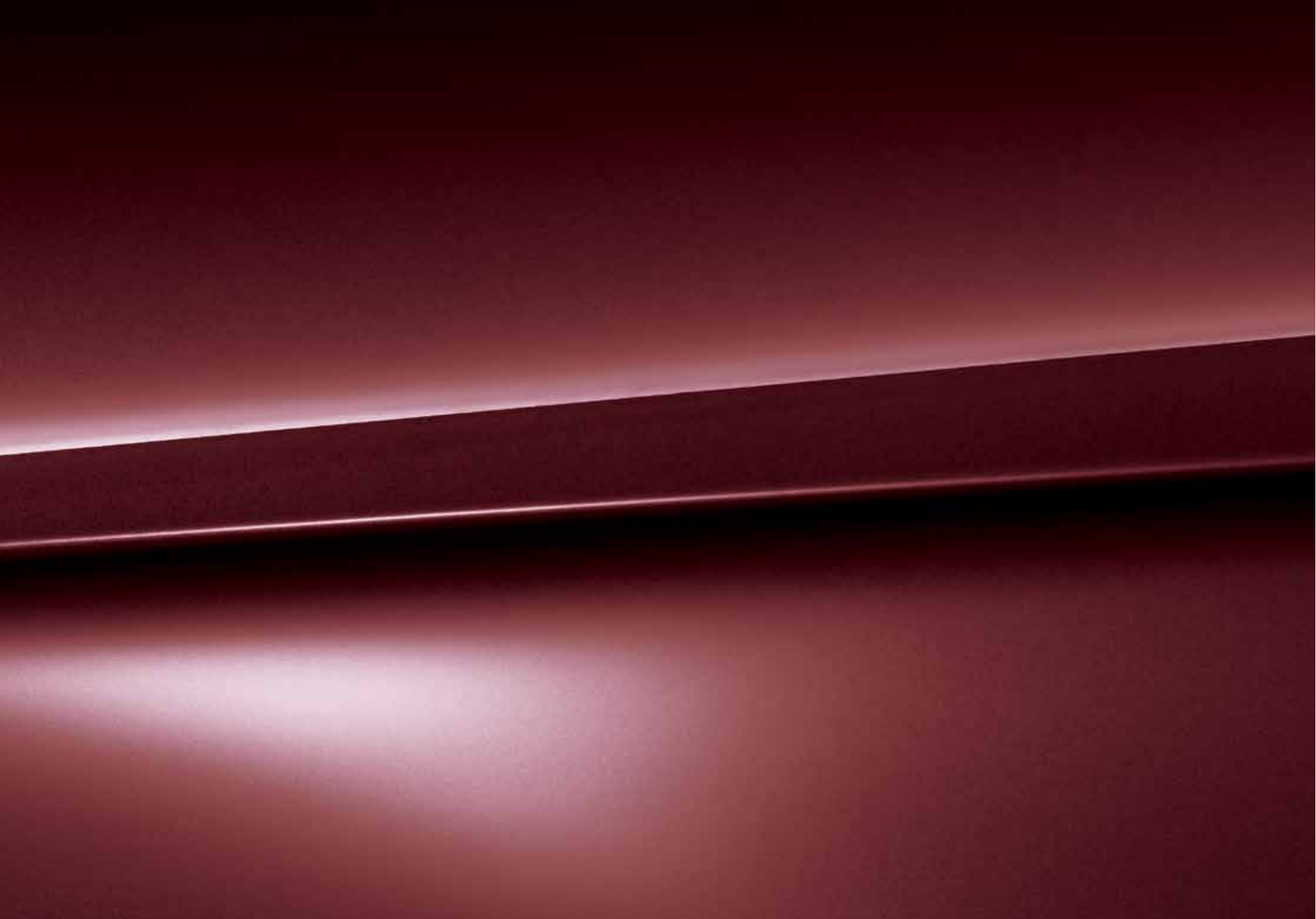

Paint

You can select one of the standard colours shown opposite or, for a different look, choose from a range of optional finishes.

Standard colours



Ibis white – T9

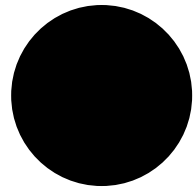

Brilliant black – A2

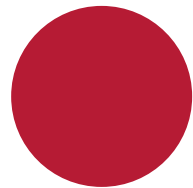

Brilliant red* – C8

Optional colours

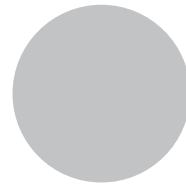

Ice silver, metallic – P5



Glacier white, metallic – 2Y

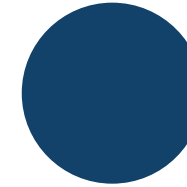

Scuba blue*, metallic – S9

S line colours

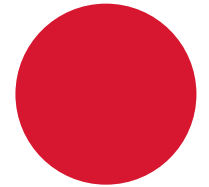

Misano red, pearl effect – N9

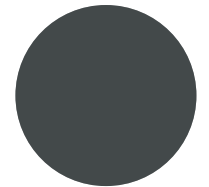

Daytona grey, pearl effect* – 6Y

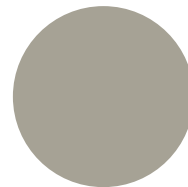

Cuvée silver*, metallic – 0D

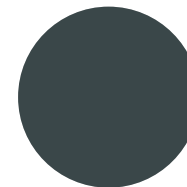

Monsoon grey, metallic – 0C

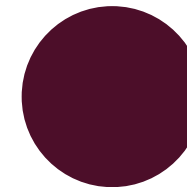

Shiraz red*, metallic – 3A

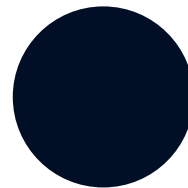

Moonlight blue, metallic – W1

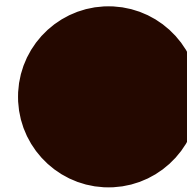

Teak brown, metallic* – 4U

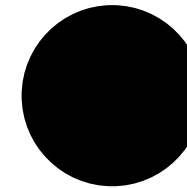

Lava grey, pearl effect – 1R

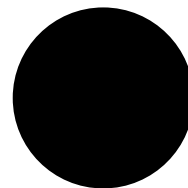

Phantom black, pearl effect – L8

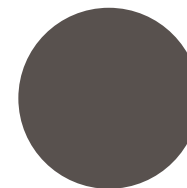

Dakota grey, metallic* – Y7

Options are subject to availability and may extend delivery.

All the colour swatches on this page are matched as accurately as possible to the actual paint colours used. However, due to print processes, Audi UK cannot guarantee that colours shown are 100% accurate.

Visit your local Audi Centre for a more accurate colour swatch.

*Not available on S5 Coupé

RRP – Recommended Retail Price.

VAT is calculated at 20% but this may alter to reflect any change in the applicable VAT rate.

Optional colours

Basic RRP

£512.50

Total RRP inc VAT

£615.00

S5 Coupé colours

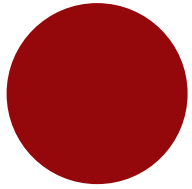

Volcano red, metallic - 1G

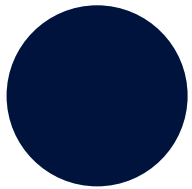

Estoril blue, crystal effect - K0

Estoril blue

Basic RRP
£720.83

Total RRP inc VAT
£865.00

Paint

Audi exclusive

Everyone has a favourite colour. No matter what yours is, Audi exclusive provides a range of unique colours that have been designed to set your car apart. Choose from the swatches here, or specify any other paint colour in the Audi range – whether it's Jet blue from the Audi R8 or Alpine white from the original Audi quattro. The choice is yours.

Customised

If you have a particular colour in mind, we'll mix the exact metallic or pearl-effect shade you want.**

*Not available on Standard models.

**Custom paint is subject to factory approval, and is available for metallic and pearl-effect water-based paints only. Three-colour process colours and two-tone schemes are not available.

†Visit your local Audi Centre for colour samples

All the colour swatches on this page are matched as accurately as possible to the actual paint colours used. However, due to print processes, Audi UK cannot guarantee that colours shown are 100% accurate.

Visit your local Audi Centre for a more accurate colour swatch.

RRP - Recommended Retail Price.

VAT is calculated at 20% but this may alter to reflect any change in the applicable VAT rate.

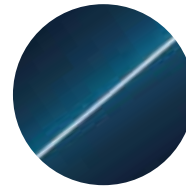

Palace blue, pearl effect

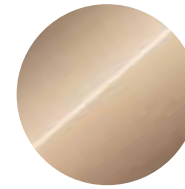

Sand beige, pearl effect

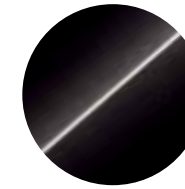

Saddle brown, pearl effect

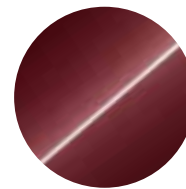

Classic red, pearl effect

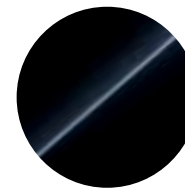

Mamba black, metallic

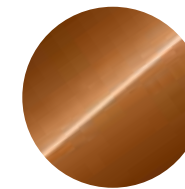

Ipanema brown, metallic



Any colour in the Audi range or 100 exclusive colours to choose from**



Customised paint

Audi exclusive*

Basic RRP
£1,762.50

Total RRP inc VAT
£2,115.00

Customised**

Basic RRP
£2,179.17

Total RRP inc VAT
£2,615.00

Upholstery

It's important to feel comfortable on the road. Just choose from our range of luxury upholstery materials and textures, including additional support and colour options, for complete relaxation while you drive.







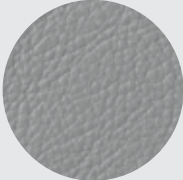

Upholstery and seats

Standard seats

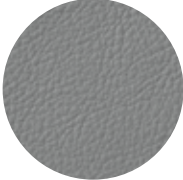
Choose your favourite upholstery from the swatches shown opposite to give your car's interior the look and feel you want.

	SE	S line	Black Edition	S5	S5 Black Edition	Basic RRP	Total RRP inc VAT
Milano leather  Black - FZ  Titanium grey - IE  Velvet beige - IF/ID	S	-	-	-	-	No charge	No charge
Fine Nappa leather*  Black - FZ  Titanium grey - IE  Chestnut brown - VR	•	-	-	-	-	£304.17	£365.00

Options are subject to availability and may extend delivery.

- = Not available
 • = Available
 S = Standard

All leather upholstery choices include seats, head restraints, door inserts and front centre armrest in leather.

*Includes leather door armrests (7HB).

Colour swatches have been matched as accurately as possible. However, they may not represent the true colour.

RRP - Recommended Retail Price.

VAT is calculated at 20% but this may alter to reflect any change in the applicable VAT rate.

Upholstery and seats

Standard seats

Front Standard seats with manual adjustment of seat height, forwards and backwards position, backrest angle and head restraint.

Order Code		SE	S line	Black Edition	S5	S5 Black Edition	Basic RRP	Total RRP inc VAT
4A3	Heated front seats with 3 stage heating control	●	–	–	–	–	£250.00	£300.00
4A4	Heated front and rear seats with 3 stage heating control. Not available on the 2.0 TDIe 163PS	●	–	–	–	–	£383.33	£460.00
7P1	Electric lumbar support for front seats with horizontal and vertical adjustment	●	–	–	–	–	£195.83	£235.00
PV1	Electrically-adjustable front seats. Includes adjustment for height, forwards and backwards position, backrest angle and lumbar support	●	–	–	–	–	£637.50	£765.00
PV3 6XL 4L6	Convenience package. Comprising electric front seats with memory function on driver's side and lumbar support. Also includes auto-dimming rear view mirror and folding and auto-dimming door mirrors with memory function and automatic kerb view function, which tilts the passenger mirror downwards towards the kerb when reverse gear is engaged	●	–	–	–	–	£1,191.67	£1,430.00

Options are subject to availability and may extend delivery.

- = Not available
- = Available
- S = Standard

RRP – Recommended Retail Price.

VAT is calculated at 20% but this may alter to reflect any change in the applicable VAT rate.



Standard seat

Upholstery and seats

Sports seats

Choose your favourite upholstery from the swatches shown opposite to give your car's interior the look and feel you want.

Options are subject to availability and may extend delivery.

- = Not available
• = Available
S = Standard











*Includes leather door armrests (7HB)

Colour swatches have been matched as accurately as possible. However, they may not represent the true colour.

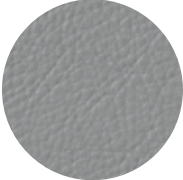
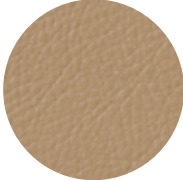
All leather upholstery choices include seats, head restraints, door inserts and front centre armrest in leather. Leather/Alcantara choices include head restraints, seat side bolsters and front centre armrest in leather with the seat centres and door inserts in Alcantara.

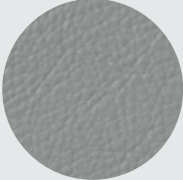
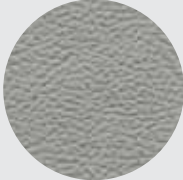
RRP - Recommended Retail Price.

VAT is calculated at 20% but this may alter to reflect any change in the applicable VAT rate.

						SE	S line	Black Edition	S5	S5 Black Edition	Basic RRP	Total RRP inc VAT
Leather/Alcantara						•	-	-	-	-	£341.67	£410.00
	Black - FZ	Titanium grey - IE	Lunar silver - IC									
Milano leather						•	-	-	-	-	£341.67	£410.00
	Black - FZ	Titanium grey - IE	Velvet beige - IF/ID									
Fine Nappa leather*						•	-	-	-	-	£645.83	£775.00
	Black - FZ	Titanium grey - IE	Lunar silver - IC	Velvet beige - IF/ID								
												
	Garnet red - IB	Chestnut brown - VR										

Upholstery and seats

Sports seats

Front Sports seats with prominent side bolsters for lateral support when cornering. Also features electric 4-way lumbar support and manual seat adjustment with extendable high support.

Order Code		SE	S line	Black Edition	S5	S5 Black Edition	Basic RRP	Total RRP inc VAT
4A3	Heated front seats with 3 stage heating control	●	–	–	–	–	£250.00	£300.00
4A4	Heated front and rear seats with 3 stage heating control. Not available on the 2.0 TDIe 163PS	●	–	–	–	–	£383.33	£460.00
PV1	Electrically-adjustable front seats. Includes adjustment for height, forwards and backwards position, backrest angle and lumbar support	●	–	–	–	–	£637.50	£765.00
PV3 6XL 4L6	Convenience package. Comprising electric front seats with memory function on driver's side and lumbar support. Also includes auto-dimming rear view mirror, and folding and auto-dimming door mirrors with memory function and automatic kerb view function, which tilts the passenger mirror downwards towards the kerb when reverse gear is engaged	●	–	–	–	–	£1,191.67	£1,430.00

Options are subject to availability and may extend delivery.

- = Not available
- = Available
- S = Standard

RRP – Recommended Retail Price.

VAT is calculated at 20% but this may alter to reflect any change in the applicable VAT rate.



Sports seat (PS1) with electrical adjustment (PV1)

Upholstery and seats

Climate comfort seats*

Choose your favourite upholstery from the swatches shown opposite to give your car's interior the look and feel you want.

	SE	S line	Black Edition	S5	S5 Black Edition	Basic RRP	Total RRP inc VAT
Milano leather	•					£2,254.17	£2,705.00
Black - FZ							
Titanium grey - IE							
Velvet beige - IF/ID							
Chestnut brown - VR							

Options are subject to availability and may extend delivery.

- = Not available
- = Available
- S = Standard

*Climate comfort seats are not available on the 2.0 TDIe 163PS.

All leather upholstery choices include seats, head restraints, door inserts and front centre armrest (if fitted) in leather.

Colour swatches have been matched as accurately as possible. However, they may not represent the true colour.

RRP - Recommended Retail Price.

VAT is calculated at 20% but this may alter to reflect any change in the applicable VAT rate.

Upholstery and seats

Climate comfort seats

Front Climate comfort seats with perforated leather on the actively ventilated and heated areas of the front seats, and on the non-ventilated areas of the rear seats.

Also includes:

- electrical adjustment for height, forwards and backwards position, backrest angle and lumbar support
- memory function for driver's seat
- folding and auto-dimming door mirrors with memory function and auto-dimming rear-view mirror
- rear bench with integral storage tray

Options are subject to availability and may extend delivery.

- = Not available
- = Available
- S = Standard

RRP – Recommended Retail Price.

VAT is calculated at 20% but this may alter to reflect any change in the applicable VAT rate.

Order Code	SE	S line	Black Edition	S5	S5 Black Edition	Basic RRP	Total RRP inc VAT
4A4 Heated front and rear seats with 3 stage heating control. Not available on the 2.0 TDIe 163PS	•					£150.00	£180.00





Climate comfort seat (PS8)

Upholstery and seats

S line Sports seats

Choose your favourite upholstery from the swatches shown opposite to give your car's interior the look and feel you want.

	SE	S line	Black Edition	S5	S5 Black Edition	Basic RRP	Total RRP inc VAT
Leather/Alcantara*  Black with grey stitching – QZ	–	•	•	–	–	No charge	No charge
Fine Nappa leather*  Black – QE	–	S	S	–	–	No charge	No charge

Options are subject to availability and may extend delivery.

- = Not available
- = Available
- S = Standard

All leather upholstery choices include seats, head restraints, door inserts and front centre armrest (if fitted) in leather.

*Includes leather door armrests (7HB)

Colour swatches have been matched as accurately as possible. However, they may not represent the true colour.

RRP – Recommended Retail Price.

VAT is calculated at 20% but this may alter to reflect any change in the applicable VAT rate.

Upholstery and seats

S line Sports seats

Front Sports seats with S line embossing and prominent side bolsters for lateral support when cornering. Also features electric 4-way lumbar support and manual seat cushion angle adjustment with extendable thigh support.

Order Code		SE	S line	Black Edition	S5	S5 Black Edition	Basic RRP	Total RRP inc VAT
4A3	Heated front seats with 3 stage heating control	-	●	●	-	-	£250.00	£300.00
4A4	Heated front and rear seats with 3 stage heating control	-	●	●	-	-	£383.33	£460.00
PV1	Electrically-adjustable front seats. Includes adjustment for height, forwards and backwards position, backrest angle and lumbar support	-	●	●	-	-	£379.17	£455.00
PV3 6XL 4L6	Convenience package. Comprising electric front seats with memory function on driver's side and lumbar support. Also includes auto-dimming rear view mirror, and folding and auto-dimming door mirrors with memory function and automatic kerb view function, which tilts the passenger mirror downwards towards the kerb when reverse gear is engaged	-	●	●	-	-	£933.33	£1,120.00

Options are subject to availability and may extend delivery.

- = Not available
- = Available
- S = Standard

RRP – Recommended Retail Price.

VAT is calculated at 20% but this may alter to reflect any change in the applicable VAT rate.



S line Sports seats

Upholstery and seats

S5 Super Sports seats

Choose your favourite upholstery from the swatches shown opposite to give your car's interior the look and feel you want.

Fine Nappa leather



Black/Black - ZM/SX

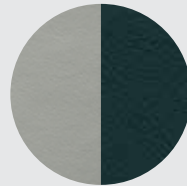

Lunar silver/Black - SU/SY



Magma red/Black - FA/SZ

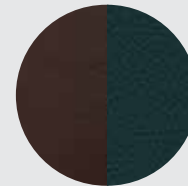

Chestnut brown/Black - SV/WY

SE	S line	Black Edition	S5	S5 Black Edition	Basic RRP	Total RRP inc VAT
I	I	I	S	S	No charge	No charge

Options are subject to availability and may extend delivery.

- = Not available
- = Available
- S = Standard

Colour swatches have been matched as accurately as possible. However, they may not represent the true colour.

RRP - Recommended Retail Price.

VAT is calculated at 20% but this may alter to reflect any change in the applicable VAT rate.

Upholstery and seats

S5 Super Sports seats

S5 Super Sports seats with integral head restraints, electrical adjustment of seat height, forwards and backwards position, backrest and seat angle. Also includes electric 4-way lumbar support, extendable thigh supports and rear bench with integral centre storage tray.

Options are subject to availability and may extend delivery.

- = Not available
- = Available
- S = Standard

RRP – Recommended Retail Price.

VAT is calculated at 20% but this may alter to reflect any change in the applicable VAT rate.

Order Code		SE	S line	Black Edition	S5	S5 Black Edition	Basic RRP	Total RRP inc VAT
4A3	Heated front seats with 3 stage heating control	-	-	-	•	•	£250.00	£300.00
4A4	Heated front and rear seats with 3 stage heating control	-	-	-	•	•	£383.33	£460.00
PV3 6XL 4L6	Convenience package. Comprising electric front seats with memory function on driver's side and lumbar support. Also includes folding and auto-dimming door mirrors with memory function and automatic kerb view function, which tilts the passenger mirror downwards towards the kerb when reverse gear is engaged plus auto-dimming rear-view mirror	-	-	-	•	•	£512.50	£615.00



S5 Super Sports seat

Colour and trim guide

Interior trim colours

Standard seats

To help you choose the right interior for your new A5 Coupé, please use this guide, showing the carpet, dashboard and headlining colours that have been matched to your chosen upholstery. Please note that the inlay colour may change dependent on the interior colours you select, please see page 58 for details.

Sports seats (PS1)

Order Code	Upholstery	Carpet	Dashboard (upper/lower)	Headlining	Milano leather (N5W)	Fine Nappa leather (N3Q)*
FZ	Black	Black	Black/Black	Silver	●	●
IE	Titanium grey	Grey	Grey/Grey	Silver	●	●
IF	Velvet beige	Brown	Brown/Brown	Beige	●	—
ID	Velvet beige	Black	Black/Black	Beige	●	—
VR	Chestnut brown	Black	Black/Black	Silver	—	●

Order Code	Upholstery	Carpet	Dashboard (upper/lower)	Headlining	Leather/Alcantara (N7U)	Milano leather (N5W)	Fine Nappa leather (N3Q)*
FZ	Black	Black	Black/Black	Silver	●	●	●
IE	Titanium grey	Grey	Grey/Grey	Silver	●	●	●
IC	Lunar silver	Black	Black/Black	Silver	●	—	●
IF	Velvet beige	Brown	Brown/Brown	Beige	—	●	●
ID	Velvet beige	Black	Black/Black	Beige	—	●	●
IB	Garnet red	Black	Black/Black	Silver	—	—	●
VR	Chestnut brown	Black	Black/Black	Silver	—	—	●

Options are subject to availability and may extend delivery.

— = Not available
● = Available

*Includes leather door armrests (7HB)

RRP – Recommended Retail Price.

VAT is calculated at 20% but this may alter to reflect any change in the applicable VAT rate.

Colour and trim guide

Interior trim colours

Climate comfort seats (PS8)

Order Code	Upholstery	Carpet	Dashboard (upper/lower)	Headlining	Milano leather (N5W)
FZ	Black	Black	Black/Black	Black	●
IE	Titanium grey	Grey	Grey/Grey	Silver	●
IF	Velvet beige	Brown	Brown/Brown	Beige	●
ID	Velvet beige	Black	Black/Black	Beige	●
VR	Chestnut brown	Black	Black/Black	Silver	●

S line Sports seats

Order Code	Upholstery	Carpet	Dashboard (upper/lower)	Headlining	Leather/Alcantara (N7K)	Fine Nappa leather (N2R)*
QE	Black (with black stitching)	Black	Black/Black	Black	—	●
QZ	Black (with grey stitching)	Black	Black/Black	Black	●	—

S5 Super Sports seats

Options are subject to availability and may extend delivery.

- = Not available
- = Available

*Includes leather door armrests (7HB)

RRP – Recommended Retail Price.

VAT is calculated at 20% but this may alter to reflect any change in the applicable VAT rate.

Order Code	Upholstery	Carpet	Dashboard	Headlining	Fine Nappa leather (N3M)*
ZM or SX	Black/Black	Black	Black	Black or Silver	●
FA or SZ	Magma red/Black	Black	Black	Black or Silver	●
SU or SY	Lunar silver/Black	Black	Black	Black or Silver	●
SV or WY	Chestnut brown/Black	Black	Black	Black or Silver	●

Upholstery

Audi exclusive

With Audi exclusive, you can specify your seats in Valcona leather or a leather/Alcantara combination, in an array of different colours shown to the right.

Select just one all-over shade for each seat, or customise each panel in two or more complementary colours from the distinctive Audi exclusive palette. You can even choose the colour of the decorative stitching – to match or contrast with your chosen upholstery – from this varied collection. Whatever combination you decide upon, we think you'll be extremely comfortable with the result.

Options are subject to availability and may extend delivery.

- = Not available
• = Available

*Leather and stitching (where applicable) can be specified in a variety of colours from the Audi exclusive range.

RRP – Recommended Retail Price.

VAT is calculated at 20% but this may alter to reflect any change in the applicable VAT rate.

Order Code		SE	S line	Black Edition	S5	S5 Black Edition	Basic RRP	Total RRP inc VAT
PYB S3G	Audi exclusive leather package 1 in Valcona leather. Includes leather-covered seat upholstery, door trim inserts and front centre armrest. Backrest covers and seat add-on parts come in the interior trim colour*. Only in combination with Sports seats (PS1)	•	•	•	•	•	£2,458.33	£2,950.00
PYC S3G	Audi exclusive leather package 1 in Valcona leather/Alcantara. Includes leather-covered seat-side trims, head restraints, front centre armrest and Alcantara door trim inserts and seat-centre sections. Backrest covers and seat add-on parts come in the interior trim colour*. Only in combination with Sports seats (PS1)	•	•	•	-	-	£2,458.33	£2,950.00
PYE S3G	Audi exclusive leather package 2 in Valcona leather. Includes all the contents of leather package 1 (PYB/S3G) plus: leather-covered seat backrest covers, door armrests and handles. Seat-side trims and add-on parts are colour-coordinated. Only in combination with electric seats (PV1) or convenience package (PV3)	•	•	•	-	-	£3,291.67	£3,950.00



Chestnut brown



Jet grey



Alabaster white

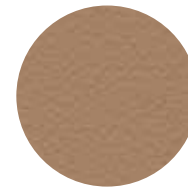

Sand beige

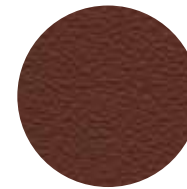

Saddle brown

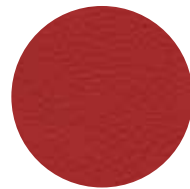

Crimson red



Magnolia white

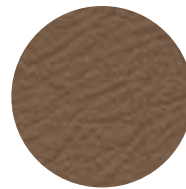

Havana brown

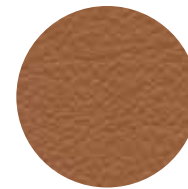

Cognac brown

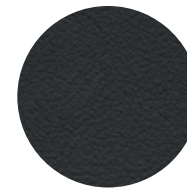

Night blue

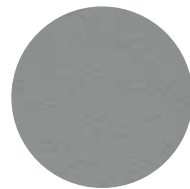

Cloudy grey

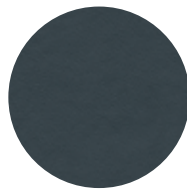

Smoky blue

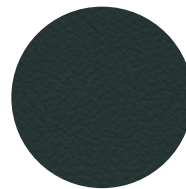

Iceland green



Powder beige

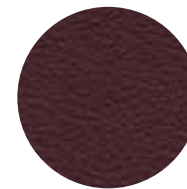

Classic red

Also available:

Alcantara colours: available in all the Audi exclusive colours shown, except for Crimson red, Jet grey and Sand beige. Alcantara equivalents are Chilli red, Amethyst grey, and Sesame beige respectively.

Please consult your Audi Centre for examples of Alcantara and carpet colours.

Upholstery

Audi exclusive line

Audi exclusive is ultimately about choice – but if you'd rather leave some of the decisions in the capable hands of our designers, the expert team at quattro GmbH have compiled Audi exclusive line, combining some of the most popular elements of the exclusive range in one, beautifully coordinated package.

Options are subject to availability and may extend delivery.

– = Not available
• = Available
S = Standard

*When ordered in combination with S line or Black Edition, Audi exclusive removes all S line interior badging.

**When ordered in combination with S line, the S line embossing on the seats is removed.

*Please note that when Audi exclusive line (PQL) is ordered in combination with Black Edition, the standard 3-spoke flat-bottomed leather steering wheel is replaced with a 3-spoke leather steering wheel (1XW/1XX).

RRP – Recommended Retail Price.

VAT is calculated at 20% but this may alter to reflect any change in the applicable VAT rate.

Order Code		SE	S line	Black Edition	S5	S5 Black Edition	Basic RRP	Total RRP inc VAT
WQK	Audi exclusive line	•					£2,250.00	£2,700.00
PQL	Audi exclusive line*		•	•			£708.33	£850.00



Cloudy grey – UH



Cognac brown – QX



Alabaster white – UA

This package includes

- ▶ Sports seats in two-tone Fine Nappa leather upholstery; black seat-side sections with coloured stitching and seat-centre sections in Cloudy grey, Cognac brown or Alabaster white**
- ▶ Door panels in Fine Nappa leather to match seat-centre section
- ▶ Black dashboard and carpets
- ▶ Black cloth headlining
- ▶ Audi exclusive door sill trims
- ▶ For SE and S line, Matt-brushed aluminium inlays. For Black Edition, Piano finish black inlays
- ▶ Floor mats in black with coloured piping (to match seat-centre section)
- ▶ 3-spoke leather steering wheel (S tronic with gear-shift paddles)*
- ▶ Steering wheel rim and gear-lever gaiter with coloured stitching in matching colour to seat-centre section

Inlays

Attention to detail can make a big impact. From contemporary black Piano finish to a brown walnut, our selection of inlays make the perfect finishing touch to your car's interior.





Inlays

Inlays are the all-important finishing touch that add flair and interest to your car's interior.

Order Code		SE	S line	Black Edition	S5	S5 Black Edition	Basic RRP	Total RRP inc VAT
5MA	Reflex finish, Steel grey or Moor brown*	S	-	-	-	-	No charge	No charge
5TG	Matt-brushed aluminium	-	S	-	S	-	No charge	No charge
5TL	Piano finish, black	-	●	S	-	S	No charge	No charge
5MU	Aluminium trigon	●	-	-	-	-	£129.17	£155.00
5MK	Carbon atlas	-	-	-	●	-	£212.50	£255.00
5MG	Walnut, brown	●	-	-	-	-	£275.00	£330.00
7TL	Fine grain ash, natural brown	●	-	-	-	-	£275.00	£330.00
5TZ	Fine grain birch wood, grey	-	●	-	●	-	£275.00	£330.00
5MZ	Stainless steel mesh (centre console comes in Piano finish, black)	-	-	-	●	-	£304.17	£365.00
5MT	Beaufort oak	●	-	-	-	-	£375.00	£450.00

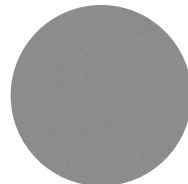

Reflex finish,
Steel grey - **5MA**



Reflex finish,
Moor brown - **5MA**

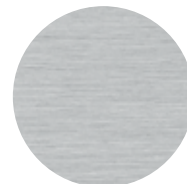

Matt-brushed aluminium - **5TG**

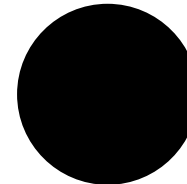

Piano finish, black - **5TL**

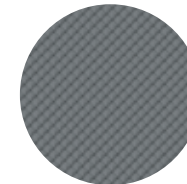

Aluminium Trigon - **5MU**



Carbon atlas - **5MK**



Walnut, brown - **5MG**



Fine grain ash,
natural brown - **7TL**



Fine grain birch wood,
grey - **5TZ**

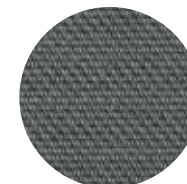

Stainless steel mesh
(centre console comes in
Piano finish, black) - **5MZ**

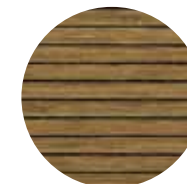

Beaufort oak - **5MT**

Options are subject to availability and may extend delivery.

- = Not available
● = Available
S = Standard

*Inlay colour dependent on interior colour, grey and black interiors will have Reflex finish Steel grey inlays. Beige interiors will have Reflex finish Moor brown inlays.

RRP - Recommended Retail Price.

VAT is calculated at 20% but this may alter to reflect any change in the applicable VAT rate.

Inlays

Audi exclusive

Audi exclusive has sourced a range of materials which you can select for your inlays, from Sepia oak to Fine grain myrtle.

Order Code		SE	S line	Black Edition	S5	S5 Black Edition	Basic RRP	Total RRP inc VAT
YTA S3G	Audi exclusive inlays (cannot be combined with the inlays shown on page 58)	•	•		•		£791.67	£950.00



Fine grain ash, nougat



Fine grain myrtle, nutmeg



Oak, sepia

Options are subject to availability and may extend delivery.

- = Not available
- = Available
- S = Standard

RRP – Recommended Retail Price.

VAT is calculated at 20% but this may alter to reflect any change in the applicable VAT rate.

Options

Every driver has different needs, which is why we have created some useful options to further enhance your car. For extra comfort, support, style or function, you can choose from a variety of additional features, tailoring everything from your infotainment and audio equipment to your wheels and lighting.





Wheels, tyres and suspension

Choose a set of specially-selected alloy wheels to subtly enhance the way your car looks and drives. And you can also specify Audi drive select, which allows you to change suspension and steering settings according to your driving style.



18" x 8.5J '5-double-spoke' design
alloy wheels - PQG



18" x 8.5J '15-spoke Star' design
alloy wheels - PRR



18" x 8.5J '5 V-spoke' design
alloy wheels - PRM



19" x 8.5J '10-spoke' design
alloy wheels - PRK



19" x 8.5J '5-spoke Y' design
alloy wheels - PRV



19" x 9J '20-spoke' design, 2-piece
alloy wheels - PQS



19" x 9J '5-segment-spoke' design
alloy wheels - PQ6



20" x 9J '7-arm double-spoke' design
alloy wheels - PQF

Wheels, tyres and suspension

Order Code		SE	S line	Black Edition	S5	S5 Black Edition	Basic RRP	Total RRP inc VAT
PQG	18" x 8.5J '5-double-spoke' design alloy wheels with 245/40 R18 tyres*	-	●	-	-	-	No charge	No charge
		●	-	-	-	-	£1,041.67	£1,250.00
PRR	18" x 8.5J '15-spoke Star' design alloy wheels with 245/40 R18 Y tyres*	●	-	-	-	-	£554.17	£665.00
PRM	18" x 8.5J '5 V-spoke' design alloy wheels with 245/40 R18 tyres*	●	-	-	-	-	£554.17	£665.00
PRK	19" x 8.5J '10-spoke' design alloy wheels with 255/35 R19 tyres*	●	-	-	-	-	£1,125.00	£1,350.00
PRV	19" x 8.5J '5-spoke Y' design alloy wheels with 255/35 R19 Y tyres*	●	-	-	-	-	£1,108.33	£1,330.00
PQS	19" x 9J '20-spoke' design, 2-piece alloy wheels with 255/35 R19 Y tyres*	●	-	-	-	-	£1,191.67	£1,430.00
		-	●	-	-	-	£383.33	£460.00
PQ6	19" x 9J '5-segment-spoke' design alloy wheels with 255/35 R19 tyres*	-	●	-	-	-	£500.00	£600.00
		-	-	●	-	●	No charge	No charge
		-	-	-	●	-	£383.33	£460.00
PQF	20" x 9J '7-arm double-spoke' design alloy wheels with 265/30 R20 tyres*	-	●	-	-	-	£1,058.33	£1,270.00
		-	-	●	-	●	£458.33	£550.00
		-	-	-	●	-	£937.50	£1,125.00

Options are subject to availability and may extend delivery.

- = Not available
● = Available
S = Standard

*Not available on the 2.0 TDIe 163PS.

RRP - Recommended Retail Price.

VAT is calculated at 20% but this may alter to reflect any change in the applicable VAT rate.

Wheels, tyres and suspension

Order Code		SE	S line	Black Edition	S5	S5 Black Edition	Basic RRP	Total RRP inc VAT
1BE	Sports suspension – with stiffer spring settings and shock absorbers	●	S	S	–	–	£262.50	£315.00
1BV	S line Sports suspension – lowered by 30mm with more firmly tuned springs and dampers for more direct contact with the road	–	●	●	–	–	No charge	No charge
2H1	Audi drive select – changes your car's handling and responses at the touch of a button to suit the way you want to drive. There are five modes: comfort, dynamic, auto, individual and efficient. Please note that you can only choose the 'individual' mode and customise your settings if you also have Satellite Navigation installed. When operating in efficiency mode, the engine and gear shift programmes are altered to optimise fuel consumption. The air conditioning system is also configured to allow for optimum energy use	●	●	●	●	●	£183.33	£220.00
1N8	Dynamic steering – with this new technology, driving is significantly more agile under everyday conditions, while directional stability and precision are increased at high speeds and in demanding driving situations. Must be combined with Audi drive select (2H1)	●	●	●	●	●	£312.50	£375.00
1BL	Damper control – formed on the basis of lowered Sports suspension, the optional damper control system fine-tunes suspension settings according to road conditions and driver needs. Must be combined with Audi drive select (2H1). Not available on the 2.0 TDIe 163PS	●	–	–	–	–	£566.67	£680.00
		–	●	●	●	●	£250.00	£300.00
GH2	Audi quattro Sports differential Must be combined with Audi drive select (2H1). Only available on 3.0 TDI 245PS and 3.0 TFSI quattro models	–	●	●	●	●	£516.67	£620.00

Options are subject to availability and may extend delivery.

– = Not available
● = Available
S = Standard

RRP – Recommended Retail Price.

VAT is calculated at 20% but this may alter to reflect any change in the applicable VAT rate.



Packages

Some items work well together, which is why we've created these special packages. They provide increased convenience and value by combining several of our most popular options.

Options are subject to availability and may extend delivery.

- = Not available
- = Available
- S = Standard

RRP – Recommended Retail Price.

VAT is calculated at 20% but this may alter to reflect any change in the applicable VAT rate.

Order Code		SE	S line	Black Edition	S5	S5 Black Edition	Basic RRP	Total RRP inc VAT
WB3 QV3	<p>Sound package Featuring Bang & Olufsen sound system and DAB digital radio</p> <p>Bang & Olufsen sound system. Designed specifically for the Audi A5, features 14 high-performance speakers and two amplifiers which create 505 Watts of stunning surround sound, balanced to suit the specific acoustic properties of the car's interior</p> <p>DAB digital radio. Receives programmes from digital radio transmitters, in addition to the range of analogue stations, with better sound quality</p>	•	•	S	•	S	£500.00	£600.00
WB6	<p>Technology package Featuring MMI Navigation system – HDD-based with Audi Music Interface and Audi parking system plus</p> <p>MMI Navigation system plus. Hard disk navigation with topographical map displays, places of interest and town models in 3D, with high-resolution 7" colour TFT display. The system offers three alternative routes, with the ability to scroll along the selected route and manoeuvre within the map. Uses 7-digit postcode recognition. Includes split-screen mode for route information, dynamic route guidance (TMC), intersection zoom function, motorway exits and lane recommendations in Driver's Information System (DIS). When combined with Mobile telephone preparation – High with Audi connect (9ZW), the system uses Google Earth images for navigation. Includes 2 SD card readers, single CD/DVD player and 40GB hard drive, Jukebox (20GB) for storing and managing music files in WMA and MP3 format. Includes European navigation data (where digitised)</p> <p>Audi Music Interface. Connection for use with stereo audio sources, USB and MP3 devices including Apple iPod generation 4 onwards and Apple iPhone</p> <p>Audi parking system plus. Acoustic and visual park assist system for the front and rear</p>	•	•	-	•	-	£1,412.50	£1,695.00
		-	-	•	-	•	£1,200.00	£1,440.00



MMI 3G – High, part of Satellite Navigation system – HDD-based

Packages

Order Code	SE	S line	Black Edition	S5	S5 Black Edition	Basic RRP	Total RRP inc VAT
PCB WB6	●	●	—	●	—	£1,933.33	£2,320.00
	—	—	●	—	●	£1,720.83	£2,065.00

Technology Package – Advanced

Includes all the features of Technology package as well as:

Adaptive cruise control with braking guard. Intelligent automatic speed and distance control system. Works at speeds from 19-155mph*, using radar sensors to measure and maintain required distance to vehicle ahead by braking and accelerating. Four programs (distance 1 to distance 4) set via steering column controls of the cruise control system. Includes Audi braking guard – a system which triggers a visual and acoustic alarm when it detects the risk of a rear end collision with the vehicle in front. At speeds below 19mph the system can initiate partial braking or full deceleration if a potential impact is detected, or if it is not possible to completely prevent a collision, the system will focus on reducing the speed at which the vehicles collide

Audi active lane assist. Helps the driver to stay in lane with gentle steering impulses for greater safety and convenience, particularly on motorways and country roads. The system informs the driver if the car is drifting out of its lane unintentionally

Options are subject to availability and may extend delivery.

- = Not available
- = Available
- S = Standard

*Where the law permits.

RRP – Recommended Retail Price.

VAT is calculated at 20% but this may alter to reflect any change in the applicable VAT rate.



Audio and communication

Stay in touch using our range of communication functions, and give each journey its own soundtrack with our advanced audio equipment.

Order Code		SE	S line	Black Edition	S5	S5 Black Edition	Basic RRP	Total RRP inc VAT
8UM	Symphony radio. AM/FM twin tuner with TP memo function. Front-loading 6-CD changer with MP3 compatibility and active front and rear speakers. Includes colour centre console screen, SD memory-card reader and AUX-IN socket. Cannot be combined with Technology Packages	•	•	•	•	•	£233.33	£280.00
QV3	DAB digital radio. Integrated into MMI, receives digitally-transmitted radio stations in addition to the range of analogue stations. Displays music track, artist and radio program. Reception dependent on local digital network. Automatic switch from DAB to FM reception if the network signal is not strong enough	•	•	S	•	S	£254.17	£305.00
9VK	Bang & Olufsen sound system. Designed specifically for the Audi A5 Coupe, featuring 14 high-performance speakers and two amplifiers which create 505 Watts of stunning sound, balanced to suit the specific acoustic properties of the car's interior. The system constantly and automatically adapts the sound characteristics to the vehicle's speed and background noise providing the highest level quality. The reproduction of 5.1 surround sound is possible in conjunction with Technology package (WB6)	•	•	S	•	S	£445.83	£535.00

Options are subject to availability and may extend delivery.

- = Not available
- = Available
- S = Standard

RRP - Recommended Retail Price.

VAT is calculated at 20% but this may alter to reflect any change in the applicable VAT rate.



Symphony radio



Bang & Olufsen sound system

Audio and communication

Options are subject to availability and may extend delivery.

- = Not available
• = Available
S = Standard

¹To check the compatibility of your mobile phone and whether it has SIM Access Profile compatibility, please visit www.audi.co.uk/owners-area/phone-compatibility.html

²Please note that when a data SIM card is inserted into the SIM card reader, Bluetooth handsfree connectivity is disabled as the SIM card takes priority over the Bluetooth connection.

³Online services are only available for mobile phone contracts including a data option and only within the coverage of the mobile phone network; there may be additional costs for the use of these services (charges and billing correspond to the personal mobile phone contract). Due to high data volumes, a mobile phone contract including an unlimited data plan is strongly recommended. The content and scope of the online-based services offered may vary.

RRP – Recommended Retail Price.

VAT is calculated at 20% but this may alter to reflect any change in the applicable VAT rate.

Order Code		SE	S line	Black Edition	S5	S5 Black Edition	Basic RRP	Total RRP inc VAT
PT5	Mobile telephone preparation – Low with Bluetooth and voice control. Provides handsfree connection via Bluetooth using mobile phone aerial. Alternatively, it can use a cradle with charging facility for optimal reception via external aerial. Located in front centre armrest. Cradle available at extra cost – please contact your Audi Centre for phone compatibility	•	•	•	–	–	£145.83	£175.00
9ZW	Mobile telephone preparation – High with Audi connect. A mobile phone can be connected to the internal UMTS (3G) module via Bluetooth (provided the mobile telephone has SIM Access Profile ¹), or alternatively through the additional SIM card reader. ² It is possible to transfer phone book entries to the car and manage call lists. Audi connect features include: navigation using Google Earth images and Google Street View, destination entry via Google Maps or myAudi, online point of interest search and information services such as weather forecasts and the latest world news. Audi connect also includes Audi traffic information online, which gives accurate real-time forecasts of the traffic situation along the chosen route. The traffic situation can be displayed on the navigation map or Google Earth image. Audi connect can also create a Wi-Fi hotspot in the car for convenient internet access using a mobile device (e.g. laptop or tablet). ³ Many Audi connect features can be simply operated via MMI Navigation Plus, the multi-function steering wheel or the voice control system. Only in combination with Technology package (WB6)	•	•	•	•	•	£291.67	£350.00
UF7	Audi Music Interface (AMI). Universal connection for use with stereo audio sources, USB and MP3 devices including Apple iPod generation 4 onwards (iPod, iPod classic, iPod mini, iPod nano, iPod photo, iPod video, iPod Touch). Provides intuitive control through the audio system and multi-function steering wheel (where fitted). It also replicates the iPod display on the audio screen and DIS, including track titles. The interface provides charging function (dependent on device). Includes 2 cables to connect your iPod or USB MP3 device	•	•	S	•	S	£212.50	£255.00
7D1	CD changer and DVD player. 6-CD changer located in the glove box and single CD/DVD slot in centre console. Only in combination with Technology package (WB6)	•	•	•	•	•	£254.17	£305.00
QU7	Digital TV reception. Reception of digital (DVB-T) uncoded television stations (MPEG-2 standard), TV picture, teletext and Electronic Programme Guide (EPG). Facility to connect 2 external AV sources via adaptor cables (available from Audi Genuine Accessories). Please note: TV reception depends on local digital network availability. No AV or TV video output when driving (audio output available when driving). Only in combination with Technology package (WB6)	•	•	–	•	–	£687.50	£825.00
QU6	Digital TV Reception and DAB digital radio reception. Reception of digital (DVB-T) uncoded television stations (MPEG-2 standard), TV picture, teletext and Electronic Programme Guide (EPG). Facility to connect 2 external AV sources via adaptor cables (available from Audi Genuine Accessories). Please note: TV reception depends on local digital network availability. No AV or TV video output when driving (audio output available when driving). Only in combination with Technology package (WB6)	•	•	–	•	–	£941.66	£1,130.00
		–	–	•	–	•	£687.50	£825.00
	In combination with sound package	•	•	–	•	–	£687.50	£825.00

Interior equipment

Specify every detail of your car's interior with this range of exclusive options.

Options are subject to availability and may extend delivery.

- = Not available
- = Available
- S = Standard

*HomeLink® is a registered trademark of Johnson Controls. For information on compatibility, visit www.homelink.com.

RRP – Recommended Retail Price.

VAT is calculated at 20% but this may alter to reflect any change in the applicable VAT rate.

Order Code		SE	S line	Black Edition	S5	S5 Black Edition	Basic RRP	Total RRP inc VAT
4F2	Advanced key. Access and authorisation system which automatically exchanges data between key and vehicle, allowing the driver to keep the key in their pocket or bag at all times. To unlock and open, simply lift the exterior door handle. To lock, press the button on the handle. Pressing the start/stop button integrated in the centre console starts and stops the engine	•	•	•	•	•	£391.67	£470.00
8T1	Cruise control. For holding any speed above 25mph	•	•	•	•	•	£187.50	£225.00
4L6	Auto-dimming rear-view mirror. Includes acoustic windscreen	•	•	•	•	•	£187.50	£225.00
8T4	Adaptive cruise control (ACC) with braking guard. Intelligent automatic speed and distance control system. Works at speeds from 19-155mph (where the law permits), using radar sensors to measure and maintain required distance to vehicle ahead by braking and accelerating. Four programs (distance 1 to distance 4) set via steering column controls of the cruise control system. Includes Audi braking guard – a system which triggers a visual and acoustic alarm when it detects the risk of a rear end collision with the vehicle in front. At speeds below 19mph the system can initiate partial braking or full deceleration if a potential impact is detected, or if it is not possible to completely prevent a collision, the system will focus on reducing the speed at which the vehicles collide	•	•	•	•	•	£937.50	£1,125.00
VC1	Garage door opener (Homelink®*). Programmable radio-operated remote control for compatible doors/gates. Control buttons integrated in the front roof module	•	•	•	•	•	£150.00	£180.00
QQ1	Interior light package. Includes front and rear footwell lighting, active door reflectors, illuminated vanity mirrors, rear reading lights, entrance lights and illuminated glove compartment, vents and internal door controls	•	•	•	S	S	£125.00	£150.00



Advanced key



Adaptive cruise control

Interior equipment

Options are subject to availability and may extend delivery.

- = Not available
- = Available
- S = Standard

*The stitching and leather piping (where applicable) can be selected from any of the Audi exclusive colours shown on page 54. The carpet colour can also be selected from any of the Audi exclusive colours shown on page 54.

RRP – Recommended Retail Price.

VAT is calculated at 20% but this may alter to reflect any change in the applicable VAT rate.

Order Code		SE	S line	Black Edition	S5	S5 Black Edition	Basic RRP	Total RRP inc VAT
PKH QE1	Storage package. Comprising storage nets on front-seat backrests, storage compartment under the front seats (if memory function is fitted, only under the front-passenger seat), drinks holder in the rear centre armrest and a lockable glove compartment. Also includes tie-down straps and 12V socket in the boot	•	•	•	•	•	£150.00	£180.00
3X2	Through-load facility. Includes removable ski bag for transporting long objects. Not available on the 2.0 TDIe 163PS	•	•	•	S	S	£137.50	£165.00
6NQ	Cloth headlining – black. Only in combination with interior colours black (FZ) or Velvet beige (ID)	•	S	S	S	S	£170.83	£205.00
7HB	Leather armrests	•	S	S	S	S	£170.83	£205.00
3Y2	Rear window blind. Electric. Not available on the 2.0 TDIe 163PS	•	•	•	•	•	£191.67	£230.00
YSR S3G	Audi exclusive floor mats with leather piping.* Includes 4 floor mats for front and rear (cannot be combined with option YSQ/S3G – Audi exclusive carpets)	•	•	•	•	•	£375.00	£450.00
YSQ S3G	Audi exclusive carpets.* Includes 4 Audi exclusive floor mats with leather piping (cannot be combined with option YSR/S3G – Audi exclusive floor mats)	•	•	•	•	•	£812.50	£975.00
6Q6	Audi exclusive aluminum gear knob. Manual gearboxes only. Not available in combination with interior code IE	•	•	•	-	-	£125.00	£150.00



Through-load facility with removable ski bag



Storage package

Exterior equipment

Make sure your car looks exactly as you want it to by selecting some of our striking options.

Order Code		SE	S line	Black Edition	S5	S5 Black Edition	Basic RRP	Total RRP inc VAT
8N7	High-beam assist. Automatically adjusts headlights from high-beam to dipped-beam when another vehicle is approaching. Only in combination with auto-dimming rear-view mirror (4L6)	●	●	●	●	●	£91.67	£110.00
8Q5	Adaptive lights. Swivelling headlights for improved illumination of winding roads	—	●	●	●	●	£275.00	£330.00
PX1 8Q5	Adaptive headlights. Swivelling headlights for improved illumination of a winding road. Includes Xenon Plus headlights with LED daytime-running lights, headlight washers and LED rear lamps	●	—	—	—	—	£941.67	£1,130.00
4ZM	Black styling package. Radiator grille-frame in highly-polished black, with radiator grille and number plate holder in matt black	●	●	S	●	S	£304.17	£365.00
2Z7	Deletion of engine technology designation at rear	●	●	●	—	—	No charge	No charge
2Z0	Deletion of model and engine technology designation at rear	●	●	●	—	—	No charge	No charge
6XE	Door mirrors – heated and electrically folding. Includes automatic kerb view function, which tilts the passenger mirror downwards towards the kerb when reverse gear is engaged	●	●	●	●	●	£150.00	£180.00
6XK 4L6	Door mirrors – electrically folding and auto-dimming. Includes auto-dimming rear-view mirror and automatic kerb function, which tilts the passenger mirror downwards towards the kerb when reverse gear is engaged	●	●	●	●	●	£404.17	£485.00
3FC	Electric tilt panoramic glass sun roof. Not available on the 2.0 TDIe 163PS	●	●	●	●	●	£725.00	£870.00
VW1	Privacy glass. Dark tinted glass from B pillar backwards	●	●	S	●	S	£275.00	£330.00
1D2	Towing equipment – removable. Includes single European 13-pin electrics socket and may require a 13- to 7-pin adaptor. Please consult your Audi Centre for details.* Not available on the 2.0 TDIe 163PS	●	●	●	—	—	£554.17	£665.00

Options are subject to availability and may extend delivery.

— = Not available
● = Available
S = Standard

*Additional wiring is required for auxiliary equipment.

RRP – Recommended Retail Price.

VAT is calculated at 20% but this may alter to reflect any change in the applicable VAT rate.

Safety and security

Intelligent technology designed to give you better all-round awareness and safety on the road.

Options are subject to availability and may extend delivery.

- = Not available
 • = Available
 S = Standard

RRP – Recommended Retail Price.

VAT is calculated at 20% but this may alter to reflect any change in the applicable VAT rate.

Order Code		SE	S line	Black Edition	S5	S5 Black Edition	Basic RRP	Total RRP inc VAT
7X4	Audi parking system plus. Aids parking by acoustically and visually indicating distances to obstacles	•	•	•	•	•	£270.83	£325.00
7X8	Audi parking system advanced. Aids parking by acoustically and visually indicating distances to obstacles with guiding lines. Measured by sensors and reversing camera. Only in combination with Technology package	•	•	•	•	•	£283.33	£340.00
UH2	Audi hill-hold assist. Uses either ESP or electromechanical parking brake to hold the vehicle stationary. Not available on the 2.0 TDIe 163PS	•	•	•	•	•	£54.17	£65.00
7Y4	Audi Active lane assist. Uses a discreet camera mounted at the top of the windscreen to monitor the road ahead. Assists the driver to stay in lane with gentle steering impulses. Informs driver if car is drifting out of lane unintentionally above 37mph. Choice of two settings: early steering intervention with continuous steering impulses to centre vehicle in lane, or late steering intervention, which alerts driver that vehicle is potentially crossing lanes and applies corrective steering prompt. Not available in combination with Audi side assist (7Y1) on the 2.0 TDIe 163PS	•	•	•	•	•	£308.33	£370.00
7Y1	Audi side assist. Aids the driver when changing lane. Audi side assist monitors the area behind the car using radar sensors located discreetly in the rear bumper, informing the driver with a visual warning signal in the door mirror if there is a vehicle in their blind spot or approaching quickly from behind. The system is activated using a button in the driver's door. Not available in combination with Audi lane assist (7Y4) on the 2.0 TDIe 163PS	•	•	•	•	•	£366.67	£440.00
7K6	Tyre pressure loss indicator. A visual and acoustic warning when the system detects a potential loss of tyre pressure	•	•	•	•	•	£62.50	£75.00

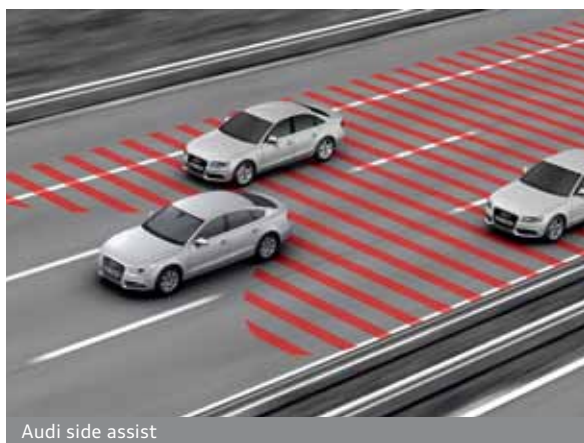

Audi side assist

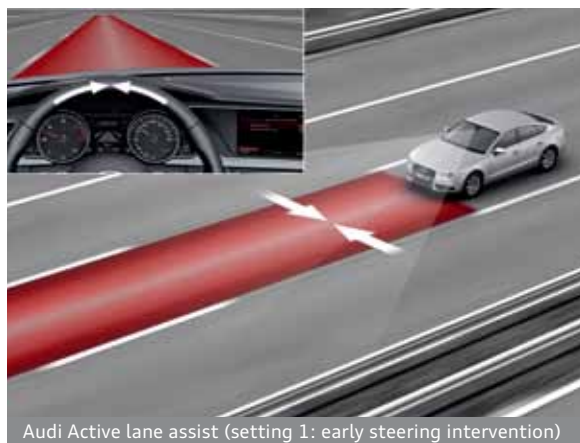

Audi Active lane assist (setting 1: early steering intervention)

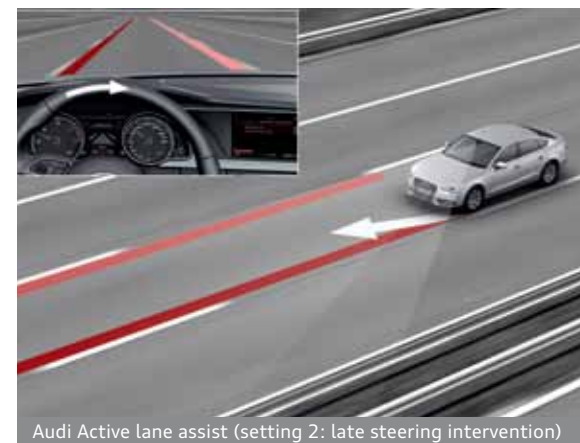

Audi Active lane assist (setting 2: late steering intervention)

Steering wheels

You can choose from a selection of advanced leather multi-function steering wheels, allowing you to control your audio system at the touch of a button.

Options are subject to availability and may extend delivery.

- = Not available
- = Available
- S = Standard

*The leather and stitching (where applicable) can be selected from any of the exclusive colours shown on page 54.

*Not in combination with Audi Exclusive Line (PQL)

RRP – Recommended Retail Price.

VAT is calculated at 20% but this may alter to reflect any change in the applicable VAT rate.

Order Code		SE	S line	Black Edition	S5	S5 Black Edition	Basic RRP	Total RRP inc VAT
2PF	3-spoke leather multi-function flat-bottomed steering wheel. Manual models only*	-	•	S	-	-	£83.33	£100.00
2PK	3-spoke leather multi-function flat-bottomed steering wheel with gear-shift paddles. Automatic models only*	-	•	S	•	S	£83.33	£100.00
YRH S3G	Audi exclusive leather-covered steering wheel*	-	•	•	•	•	£375.00	£450.00
YRB S3G	Audi exclusive controls pack. Includes leather-covered steering wheel and gear-shift gaiter*	•	•	•	•	•	£625.00	£750.00





Looking after your Audi

When you've chosen your ideal model, it's reassuring to know that it will remain in safe hands. That's why we've created products to protect your Audi, from extended warranties to Audi Complete – our comprehensive service and maintenance package. And there's also a range of Audi accessories and merchandise to choose from, enabling you to further enhance and safeguard your car.





Audi Complete

Audi Complete is simply a way to look after the servicing and maintenance costs for your Audi in a single package. You pay a one-off or monthly fee and we'll cover all your servicing, maintenance and tyres for the next three years including your first MOT. It means you only have to pay for fuel, insurance and your Road Fund Licence. So you can be reassured that your car will be maintained by trained Audi Technicians, using genuine Audi parts.

*Retail customers only. Pricing based on 3 years/30,000 miles (whichever occurs sooner). All pricing is a 'starting from' price for the Audi A5 Coupé model range and is therefore subject to change and mileage/model dependent.

Warranty

Options are subject to availability and may extend delivery.

- = Not available
• = Available
S = Standard

**Only available prior to registration of your A5. Please speak to your Audi Centre for full details.

RRP – Recommended Retail Price.

VAT is calculated at 20% but this may alter to reflect any change in the applicable VAT rate.

Order Code		A5	S5	Basic RRP	Total RRP inc VAT
-	Audi Complete – Service and Maintenance. Comprehensive care for your Audi covering all your servicing and maintenance for 3 years, as well as your first MOT. Visit your local Audi Centre for further details or audi.co.uk/audicomplete for full details including terms and conditions	•	-	£20.83	£25.00*
		-	•	£32.50	£39.00*
-	Audi Complete – Service, Maintenance and Tyres. Comprehensive care for your Audi covering all your servicing, maintenance and tyres for 3 years, as well as your first MOT. Visit your local Audi Centre for further details or audi.co.uk/audicomplete for full details including terms and conditions	•	-	£29.17	£35.00*
		-	•	£64.17	£77.00*

Order Code		A5	S5	Basic RRP	Total RRP inc VAT
-	Audi Warranty, covering you for unlimited mileage in the first two years of ownership, and up to 60,000 miles in the third year. Transferable between owners**	S	S	No charge	No charge
EA6	Audi Warranty, covering you for up to 4 years or 75,000 miles, whichever comes soonest. Cover includes a two-year unlimited mileage warranty, and up to 75,000 miles in the third and fourth years. Transferable between owners**	•	•	£445.83	£535.00
EA9	Audi Warranty, covering you for up to 5 years or 90,000 miles, whichever comes soonest. Cover includes a two-year unlimited mileage warranty, and up to 90,000 miles in the third, fourth and fifth years. Transferable between owners**	•	•	£1,045.83	£1,255.00

Accessories

Choosing an Audi isn't just a matter of deciding on the model you want; it's about creating a car that suits your needs perfectly. And that's why we've developed a whole range of accessories to enhance your A5 Coupé, enabling you to customise it down to the last detail. Like your Audi, all these accessories are developed to the highest possible standards. They're all available exclusively from Audi.

To find out more, just visit audi.co.uk/accessories or contact your local Audi Centre.

Warranty

All of the accessories available for the A5 Coupé are covered by a three-year warranty* if they are ordered and included in the purchase price of the car at date of delivery. Any accessories ordered and installed after delivery include a two-year warranty.*

*Excluding Road Angel products.
Audi Accessories warranty terms and conditions can be found at audi.co.uk



Merchandise

From the enthusiasts' motorsport collection to the sophisticated Audi collection, there's a wide variety of adults' and children's clothing, lifestyle accessories and collectables, all of which bear the Audi name.

Please speak to a member of our team at your local Audi Centre to see the full Audi collection and to place an order. A selection of Audi merchandise is also available to buy from audi.co.uk/merchandise



Audi Difference

The experts in Vorsprung durch Technik

Our Audi Approved Master Technicians have undergone an impressive 100,000 hours of training over a 10-year programme to ensure they have the latest technical expertise for maintaining and servicing your Audi. All our Service Advisors undergo a specialist induction and training to ensure they are Audi professionals and able to talk to you about any issues you may have with your Audi vehicle.

Servicing tailored to your needs

Regular servicing is key to safeguarding your Audi's performance and a full Audi service history could help you enhance the future re-sale value. To make servicing easy, the Audi Service Schedules have been designed to work with your individual driving style and vehicle.

We offer two different schedules: the fixed Inspection Service and the variable LongLife Service schedule. The conventional fixed Inspection Service schedule has fixed intervals for the Oil-change Service and Inspection Service, which are determined by time and distance.

With the variable LongLife Service schedule, the Inspection Service intervals are also fixed but the Oil-change Service intervals are variable. Sensors take account of driving style and conditions to determine when the Oil-change Service is required and the driver is informed via the on-board service interval display.

The choice of Service Schedule will depend on journey type and mileage as well as individual driving style and conditions. The table to the right can be used for guidance but your Audi Centre will help you to determine the most suitable Service schedule for you based on your individual circumstances and preferences.

Fixed Inspection Service Schedule

	Vehicle usage:
Mileage	Less than 10,000 miles per annum Mainly city/town centre driving. Short journeys.
	Service Intervals:
Oil-change Service	Fixed to every 9,000+ miles/1 year
Inspection Service	Fixed to every 19,000+ miles/2 years

Variable LongLife Service Schedule

	Vehicle usage:
Mileage	More than 10,000 miles per annum Motorway and main road driving. Mainly longer distance journeys. Constant speeds.
	Service Intervals:
Oil-change Service	Variable to a maximum of every 19,000+ miles/2 years
Inspection Service	Fixed to every 19,000+ miles/2 years

When a vehicle is frequently used in the following conditions, we recommend the vehicle is on a Fixed Inspection Service Schedule, regardless of mileage:

Uneconomical driving styles, i.e. heavy acceleration and braking, constant use of high revs
High engine loading conditions, i.e. frequent towing and hill climbs

*As indicated by the service interval display. Mileages are approximate as the Service Indicator system uses kilometres as its distance measurement.

Your convenience comes first

At Audi you can choose from a range of convenient services that suit your needs. Why not book a 'service while you wait' appointment* and enjoy our complimentary refreshments while your car is with us? Or, if you need to be mobile, take advantage of one of our courtesy cars which we can even collect and deliver to you.* We guarantee we can service your Audi within 5 days without a courtesy car, or within 10 days if you need transport. We will also ensure your car is returned to you with a full valet.

Audi Genuine Parts

You can rest assured that only Audi Genuine Parts will be used on your vehicle. What's more, Audi parts and labour come with a 2-year guarantee.**

No hidden costs

We believe strongly in transparency when it comes to our prices. For added peace of mind, we will give you a quotation over the phone for the work you have requested and email you the price confirmation. We'll consult you if any additional work on your car is needed when it is with us. We won't carry out any extra work without asking your permission first.

All part of the service

Whenever we see an Audi for a service, we connect it directly to our headquarters in Ingolstadt which enables us to check your car's software and make sure it's as up-to-date as possible. If the factory has released a software upgrade for your model, it can be applied immediately - improving anything from your car's efficiency to the precision of its parking system.

Audi Roadside Assistance

Your new car comes complete with 3 years' complimentary roadside assistance and recovery across the UK provided by RAC Motoring Services. Also included is roadside assistance throughout Europe, managed by RAC Motoring Services.

For further information and terms and conditions please visit audi.co.uk

* Subject to availability

**Excludes wear and tear.



A5 Coupé Petrol technical data

Engine	1.8 TFSI	1.8 TFSI	2.0 TFSI quattro	2.0 TFSI quattro
Transmission	6-speed manual	8-speed multitronic	6-speed manual	7-speed S tronic
Cylinder	4-cylinder	4-cylinder	4-cylinder	4-cylinder
Displacement, cubic cm (valves per cylinder)	1798	1798	1984	1984
Max. power, ¹ PS	170	170	211	211
Max. torque, Nm at rpm	320/1400-3700	320/1400-3700	350/1500-4200	350/1500-4200
Top speed, mph	143	142	153	152
0-62mph acceleration, seconds	7.9	8.2	6.4	6.5
CO ₂ emissions, ² g/km	134	134	159	159
Benefit in kind (BIK)%	17%	17%	22%	22%
Fuel consumption ² , mpg (l/100km) Urban	38.2 (7.4)	40.9 (6.9)	31.7 (8.9)	32.1 (8.8)
Fuel consumption ² , mpg (l/100km) Extra Urban	58.9 (4.8)	55.4 (5.1)	50.4 (5.6)	48.7 (5.8)
Fuel consumption ² , mpg (l/100km) Combined	49.6 (5.7)	48.7 (5.8)	41.5 (6.8)	40.4 (7.0)
ABI insurance group ⁴ 1-50	27E	27E	33E	33E
Unladen weight, ³ kg	1425	1455	1510	1550
Gross weight limit, kg	1925	1955	2010	2050
Roof load limit/nose weight, kg	75/80	75/80	75/80	75/80
Max trailer load unbraked ⁵ , kg	750	750	750	750
Max trailer load with 12% gradient ⁵ , kg	1500	1300	1700	1700
Max trailer load with 8% gradient ⁵ , kg	1700	1500	1900	1900
Luggage compartment capacity, rear seats upright, litres	455	455	455	455
Luggage compartment capacity, rear seats folded, litres	829	829	829	829
Fuel tank capacity approx, litres	63	63	61	61

⁴Highest insurance group rating shown. Group may be lower dependent on trim level. Please visit www.thatcham.org/abigrouprating for details.

¹The given value was obtained in accordance with the specified measurement procedure (the respective current version of the Directive 80/1269/EEC).

²Fuel consumption and CO₂ emissions figures are obtained under standardised test conditions (Directive 93/116/EEC) using a representative model. This allows direct comparison between different models from different manufacturers, but may not represent the actual fuel consumption achieved in 'real world' driving conditions. More information is available at www.vca.gov.uk.

³Vehicle's unladen weight without driver (calculated in accordance with the current version of Directive 80/1268/EEC). The fitting of additional equipment may increase the vehicle's unladen weight and drag coefficient, whereupon the potential carrying capacity and top speed will be correspondingly reduced.

⁴The engine's power output always goes down with increasing altitude. At 1,000m above sea level, and for every additional 1,000m, deduct 10% from the weight of the outfit (trailer load limit + gross weight of the towing vehicle).

Please note: The maximum power output figures are quoted in PS (or Pferdestärke, which is the metric equivalent of brake horsepower). To convert to brake horsepower, divide the PS figure by 1.0139.

A5 Coupé Diesel technical data

Engine	2.0 TDIe	2.0 TDI	2.0 TDI	2.0 TDI quattro	2.0 TDI quattro	3.0 TDI	3.0 TDI quattro
Transmission	6-speed manual	6-speed manual	multitronic	6-speed manual	7-speed S tronic	multitronic	7-speed S tronic
Cylinder	4-cylinder	4-cylinder	4-cylinder	4-cylinder	4-cylinder	6-cylinder	6-cylinder
Displacement, cubic cm (valves per cylinder)	1968	1968	1968	1968	1968	2967	2967
Max. power, ¹ PS	163	177	177	177	177	204	245
Max. torque, Nm at rpm	380/1750-2500	380/1750-2500	380/1750-2500	380/1750 - 2500	380/1750 - 2500	400/1250-3500	500/1400-3250
Top speed, mph	140	143	140	142	140	146	155 ⁺
0-62mph acceleration, seconds	8.4	8.2	7.8	7.8	7.8	7.1	5.8
CO ₂ emissions, ² g/km	115	120	123	134	139	129	149
Benefit in kind (BIK)%	17%	18%	18%	20%	21%	19%	23%
Fuel consumption ² , mpg (l/100km) Urban	52.3 (5.4)	51.4 (5.5)	51.4 (5.5)	46.3 (6.1)	44.1 (6.4)	51.4 (5.5)	41.5 (6.8)
Fuel consumption ² , mpg (l/100km) Extra Urban	74.3 (3.8)	68.9 (4.1)	65.7 (4.3)	62.8 (4.5)	60.1 (4.7)	61.4 (4.6)	55.4 (5.1)
Fuel consumption ² , mpg (l/100km) Combined	64.2 (4.4)	61.4 (4.6)	60.1 (4.7)	55.4 (5.1)	53.3 (5.3)	57.6 (4.9)	49.6 (5.7)
ABI insurance group* 1-50	28E	29E	29E	29E	29E	30E	35E
Unladen weight, ³ kg	1475	1470	1495	1535	1575	1565	1640
Gross weight limit, kg	1975	1970	1995	2035	2075	2065	2140
Roof load limit/nose weight, kg	75/80	75/80	75/80	75/80	75/80	75/80	75/80
Max trailer load unbraked, ⁴ kg	750	750	750	750	750	750	750
Max trailer load with 12% gradient, ⁴ kg	1300	1600	1700	1600	1700	1700	1900
Max trailer load with 8% gradient, ⁴ kg	1500	1800	1900	1800	1900	1900	2100
Luggage compartment capacity, rear seats upright, litres	455	455	455	455	455	455	455
Luggage compartment capacity, rear seats folded, litres	829	829	829	829	829	829	829
Fuel tank capacity approx, litres	63	63	63	61	61	63	61

*Highest insurance group rating shown. Group may be lower dependent on trim level. Please visit www.thatcham.org/abigrouprating for details.

⁺Electronically limited.

¹The given value was obtained in accordance with the specified measurement procedure (the respective current version of the Directive 80/1269/EEC).

²Fuel consumption and CO₂ emissions figures are obtained under standardised test conditions (Directive 93/116/EEC) using a representative model. This allows direct comparison between different models from different manufacturers, but may not represent the actual fuel consumption achieved in 'real world' driving conditions. More information is available at www.vca.gov.uk.

³Vehicle's unladen weight without driver (calculated in accordance with the current version of Directive 80/1268/EEC). The fitting of additional equipment may increase the vehicle's unladen weight and drag coefficient, whereupon the potential carrying capacity and top speed will be correspondingly reduced.

⁴The engine's power output always goes down with increasing altitude. At 1,000m above sea level, and for every additional 1,000m, deduct 10% from the weight of the outfit (trailer load limit + gross weight of the towing vehicle).

Please note: The maximum power output figures are quoted in PS (or Pferdestärke, which is the metric equivalent of brake horsepower). To convert to brake horsepower, divide the PS figure by 1.0139.

S5 Coupé technical data

*Highest insurance group rating shown. Group may be lower dependent on trim level. Please visit www.thatcham.org/abigroupratings for details.

†Electronically limited.

¹The given value was obtained in accordance with the specified measurement procedure (the respective current version of the Directive 80/1269/EEC).

²Regulated.

³Fuel consumption and CO₂ emissions figures are obtained under standardised test conditions (Directive 93/116/EEC) using a representative model. This allows direct comparison between different models from different manufacturers, but may not represent the actual fuel consumption achieved in 'real world' driving conditions. More information is available at www.vca.gov.uk.

⁴Vehicle's unladen weight without driver (calculated in accordance with the current version of Directive 80/1268/EEC). The fitting of additional equipment may increase the vehicle's unladen weight and drag coefficient, whereupon the potential carrying capacity and top speed will be correspondingly reduced.

⁵The engine's power output always goes down with increasing altitude. At 1,000m above sea level, and for every additional 1,000m, deduct 10% from the weight output (trailer load unit + gross weight of the towing vehicle).

Please note: The maximum power output figures are quoted in PS (or Pferdestärke, which is the metric equivalent of brake horsepower). To convert to brake horsepower, divide the PS figure by 1.0139.

Engine	S5 Coupé quattro
Transmission	7-speed S tronic
Cylinder	V6
Displacement, cubic cm (valves per cylinder)	2995
Max. power ¹ , PS	333
Max. torque, Nm at rpm	440/2900-5300
Top speed ² , mph	155 [†]
0-62mph acceleration, seconds	4.9
CO ₂ emissions ³ , g/km	190
Benefit in kind (BIK)%	29%
Fuel consumption ³ , mpg (l/100km) Urban	26.4 (10.7)
Fuel consumption ³ , mpg (l/100km) Extra Urban	42.8 (6.6)
Fuel consumption ³ , mpg (l/100km) Combined	34.9 (8.1)
ABI insurance group 1-50*	41E
Unladen weight, ⁴ kg	1675
Gross weight limit, kg	2175
Roof load/nose weight, kg	75/80
Max trailer load unbraked, ⁵ kg	750
Max trailer load with 12% gradient, ⁵ kg	1900
Max trailer load with 8% gradient, ⁵ kg	2100
Luggage compartment capacity, rear seats upright, litres	455
Luggage compartment capacity, rear seats folded, litres	829
Fuel tank capacity approx, litres	61



A5 Coupé dimensions

The technical drawings opposite show the exact dimensions of the Audi A5 Coupé, so you can check everything – from whether the car will fit in your garage to whether your luggage will fit in the boot.

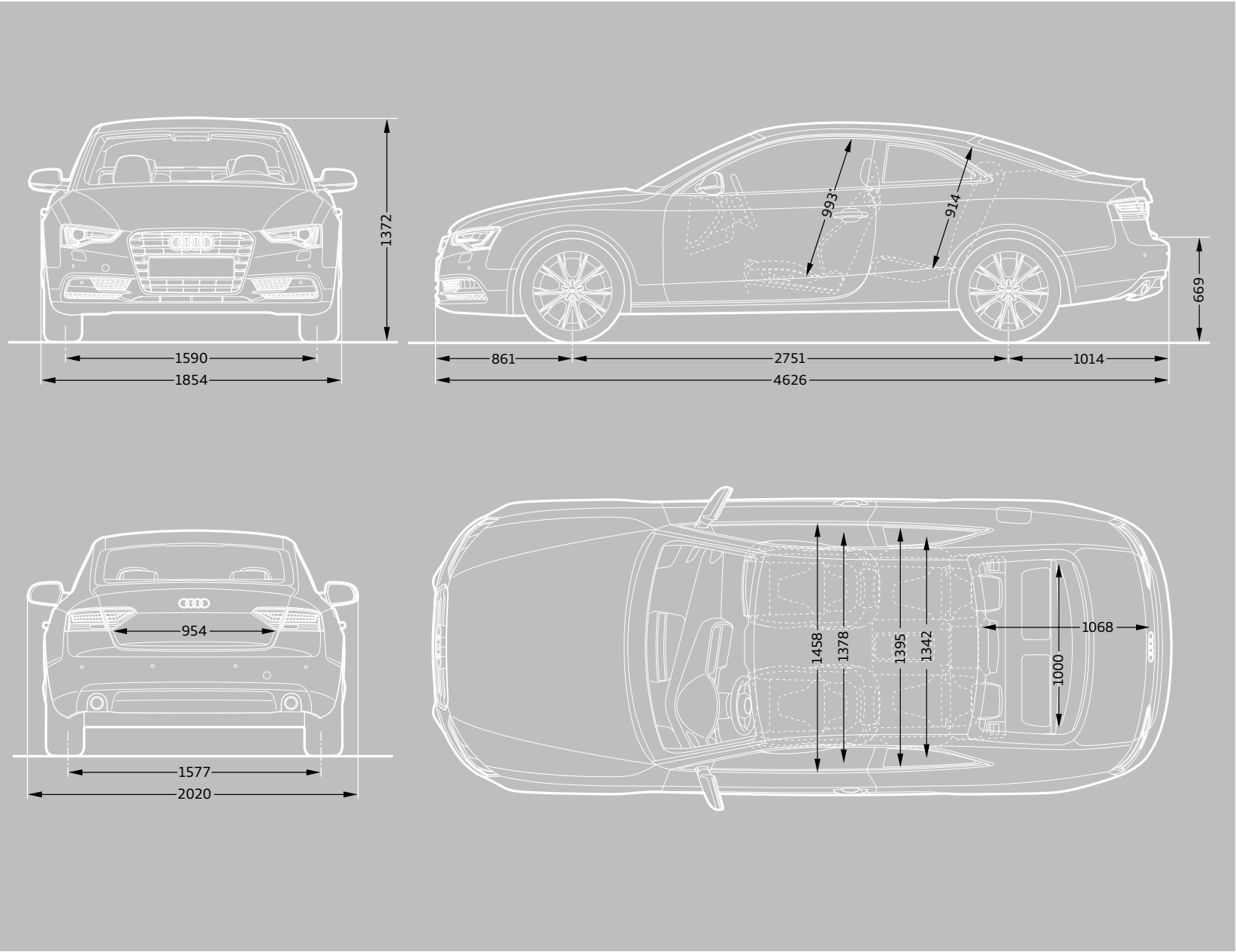

*Maximum headroom.
Dimensions in millimetres.

Dimensions were measured with vehicle at unladen weight. Luggage compartment volume in litres: 455/829 (measured by the VDA standard test method using 200 x 100 x 50mm blocks; second value: with rear seat folded down). Turning circle approx 11.4m.

S5 Coupé quattro dimensions

The technical drawings opposite show the exact dimensions of the Audi S5 Coupé quattro, so you can check everything – from whether the car will fit in your garage to whether your luggage will fit in the boot.

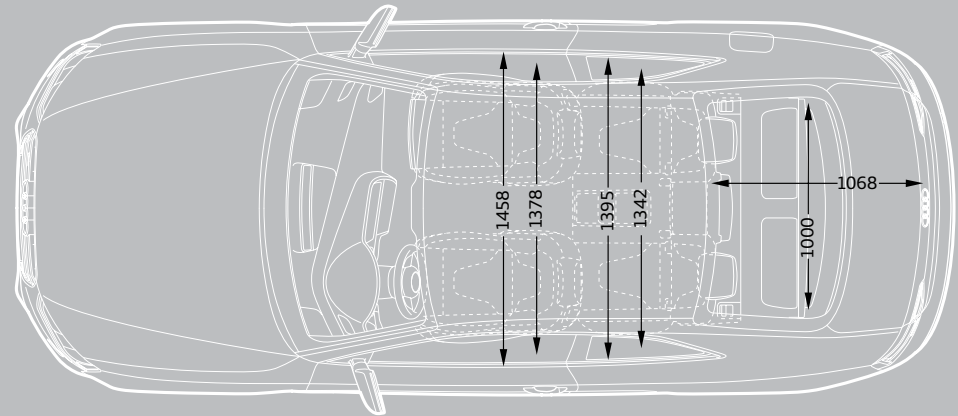
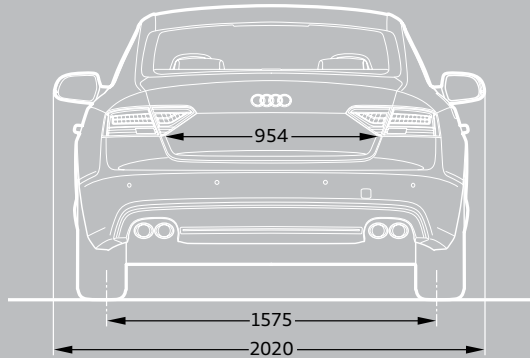
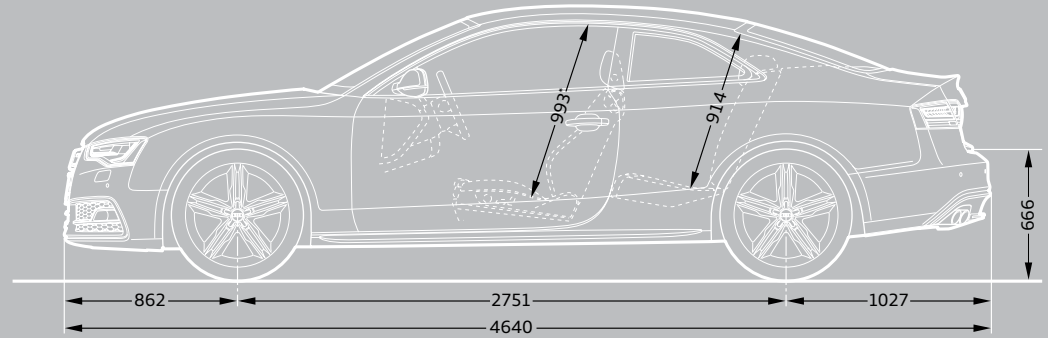
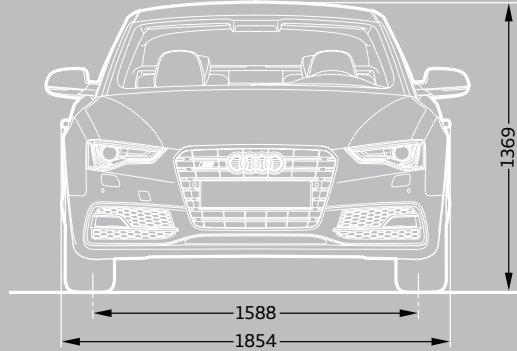

*Maximum headroom.
Dimensions in millimetres.

Dimensions were measured with vehicle at unladen weight. Luggage compartment volume in litres: 455/829 (measured by the VDA standard test method using 200 x 100 x 50mm blocks; second value: with rear seat folded down). Turning circle approx 11.4m.

Pricing and Additional information

Welcome to Audi

By placing an order for your Audi, you're choosing to get behind the wheel of one of the most sophisticated cars on the road. And because we believe the service we offer should be just as advanced, we wanted to let you know exactly what you can expect from us, now and in the future.

We've agreed a set of standards with all our Centres, which governs the way we do business with you. It outlines the kind of service we promise to deliver for every customer, right down to filling each new Audi we sell with half a tank of fuel.

So whether you're interested in the date your car will arrive in the UK or the way we'll dispose of non-biodegradable materials after we service your Audi, you can have total confidence in us.

Audi Promise

Audi Centres

We guarantee that all our Centres will be open as follows:

Sales: Monday to Friday 9am–6pm
Saturday 9am–5pm

Service: Monday to Friday 8am–6pm
Saturday 8.30am–1pm

Sunday opening is at local discretion.

New car delivery

Once we've confirmed a delivery date for your car, we'll keep you informed of progress. Subject to reasonable notice, we'll then deliver it to a place of your choice, whether that's your home or work. In the unlikely event of a delay, we'll provide a courtesy car to minimise inconvenience and keep you mobile..

Environmental commitment

We promise to dispose of all non-biodegradable materials from your vehicle in a responsible manner.

*Subject to availability.

**Excludes wear and tear.

Pricing

Prices and specifications given are correct at the time of printing. Always check details with your Audi Centre, as Audi policies are continually developing. We reserve the right to change prices or specifications at any time.

All prices are subject to VAT, currently charged at 20% but this may alter to reflect any change in the applicable VAT rate.

Delivery charges and number plates are not included in the vehicle price.

Delivery charge	£471.66
Number plate	£20.00
VAT	£98.34
Total	£590.00

Audi Insurance is a trading name of Volkswagen Insurance Service (Great Britain) Limited, an appointed representative of Volkswagen Financial Services (UK) Limited, Brunswick Court, Yeomans Drive, Blakelands, Milton Keynes MK14 5LR. Registered in England number 2835230. Audi Insurance is sold, underwritten and administered by Allianz Insurance plc registered in England number 84638. Registered office 57 Ladymead, Guildford, Surrey GU1 1DB. Volkswagen Financial Services (UK) Limited and Allianz Insurance plc are authorised and regulated by the Financial Services Authority. Volkswagen Financial Services (UK) Limited and Allianz Insurance plc are not part of the same corporate group.

Audi Customer Care

Every new Audi benefits from the comprehensive Audi Customer Care Package, which comprises:

- ▶ A 3-year Audi warranty, which covers you for unlimited mileage in the first 2 years of ownership, with a full mechanical and electrical warranty which covers you for up to 60,000 miles in the 3rd year
- ▶ A 3-year paint warranty
- ▶ A 12-year anti-corrosion warranty
- ▶ 3 years' UK roadside assistance and recovery

You also have the option when ordering your new car of choosing a 4-year or 5-year Audi warranty. Speak to a member of the sales team for more information.

Audi Tax-Free Sales

If you are entitled to purchase a vehicle free of VAT, normally through Military or Diplomatic privilege, please contact your local Audi Centre for full details.

Should you have any difficulty obtaining the information you require, please call Freephone 0800 585878.

Audi Finance

Audi Finance specialise in providing funding solutions for Audi drivers. Whether your Audi is for private or business use, there are a range of funding options to choose from.

Below is the full range of finance products.

- ▶ Solutions – a Personal Contract Plan
- ▶ Hire purchase
- ▶ Lease purchase
- ▶ Finance lease
- ▶ Contract hire

With all products, you can choose a fixed-cost maintenance plan designed to help you budget accurately.

No matter what Audi model you choose, your local Audi Centre can provide you with a personalised quote which could fit your budget and motoring needs.

Audi Finance is a trading name of Volkswagen Financial Services (UK) Limited. An offer of finance depends on certain conditions. Available to people over 18 in the UK only.

Audi Insurance

We want you to start enjoying your new car from day one and thanks to Audi Insurance complimentary seven day cover, you can. Call free on 0800 316 7893 (lines are open Monday to Friday 8am - 9pm, and Saturday 9am - 5pm), provide a few details and a cover note will be sent to your Audi Centre. They will then tax your car and you can drive it away.

Additional information

CO₂ data and information

CO₂ emissions-based Vehicle Excise Duty

Vehicle Excise Duty (Road Fund Licence) is based upon the amount of Carbon Dioxide (CO₂) a vehicle emits, measured in grams per kilometre (g/km). First year VED rates apply to the first year of ownership. Annual VED rates apply thereafter. The DVLA has created thirteen categories:

Petrol and Diesel engines	First year	Annual rate (second year onwards)
A – up to 100g/km	£0.00	£0.00
B – 101 to 110g/km	£0.00	£20.00
C – 111 to 120g/km	£0.00	£30.00
D – 121 to 130g/km	£0.00	£100.00
E – 131 to 140g/km	£120.00	£120.00
F – 141 to 150g/km	£135.00	£135.00
G – 151 to 165g/km	£170.00	£170.00
H – 166 to 175g/km	£275.00	£195.00
I – 176 to 185g/km	£325.00	£215.00
J – 186 to 200g/km	£460.00	£250.00
K – 201 to 225g/km	£600.00	£270.00
L – 226 to 255g/km	£815.00	£460.00
M – over 255g/km	£1,030.00	£475.00

Vehicle Excise Duty (VED) rates correct at time of going to print, but these may alter to reflect any change in the applicable VED rate





Audi UK

Customer Services
Selectapost 29
Sheffield
S97 3FG
0800 699888
audi.co.uk

Specifications and prices subject
to change without notice.

© Audi UK

Printed in the UK
Edition 1.3 03/13
2013 model year

Images are for illustrative purposes only.

