



**The new Audi A6 allroad**

Pricing and Specification Guide

Valid from May 2013



# Personalising your Audi A6 allroad

This guide has been designed to help you tailor and price your Audi A6 allroad quickly and logically. At the back, you will find information on CO2 emissions-based taxation and the other services offered by Audi, including Finance and Insurance. You can also configure your Audi A6 allroad online at [audi.co.uk](http://audi.co.uk).

## Audi Vision

To accompany this printed guide, we've created Audi Vision – an intuitive app that lets you find out even more about the Audi A6 allroad. Compatible with Apple and Android phones and tablets, Audi Vision gives you exclusive access to images, information and video content – all of which is designed to help you explore and understand the options available with this model.

You'll see the Audi Vision logo printed next to the page number on pages throughout this guide and wherever you do, you'll be able to view additional content on that page.



## The Audi A6 allroad

Engine	12
Transmissions	13
Efficiency	14
quattro®	16

## Model details and prices

Standard model equipment	20
Model prices	24

<b>Audi exclusive</b>	26
-----------------------	----

## Colour and upholstery

Paint	28
Upholstery	32
Colour and trim guide	38

<b>Inlays</b>	42
---------------	----

## Options

Wheels and tyres	46
Packages	50
Audio and communication	52
Interior equipment	56
Exterior equipment	58
Safety and security	60
Steering wheels	64

## Looking after your Audi

Audi Complete and Warranty	66
Accessories	69
Merchandise	70
Audi Difference	71

## Technical details

Technical data	72
Dimensions	73
Pricing and Additional information	74







## Vorsprung durch Technik

Three words that express the very essence of Audi. Vorsprung durch Technik isn't a slogan. It's our way of seeing the world. It is the driving force behind our history of innovation that continues into the 21st century. Indeed, many technologies that Audi pioneered remain in our cars today. Some are milestones in the history

of the motorcar. From our beginnings in 1899, to the Auto Union team's Grand Prix successes in the 1930s and our more recent wins at Le Mans, we have always been at the forefront of the motor industry.

Vorsprung durch Technik makes us who we are. To see more of its influence, just read on.









## The Audi A6 allroad

It's all in the name. The Audi A6 allroad is fit for all terrains – rugged or flat, town or country – thanks partly to the extraordinary road-holding of quattro® permanent all-wheel-drive. In the same way that our hands adjust to whatever we're holding, quattro® continuously adapts to suit the terrain. So it maintains the car's traction and stability, keeping you in control on the road – and, of course, off it.

Inside, you'll find luxurious Milano leather upholstery and Satellite Navigation as standard. Not to mention Adaptive air suspension and Cruise control, providing an exceptionally smooth ride on any surface. And with options including Adaptive bi-Xenon or All-LED headlights and Bang & Olufsen Advanced Sound System, you'll enjoy your drive wherever your journey may take you.













## **A6 allroad interior story**

We've introduced a number of finishing touches to the Audi A6 allroad interior to make your driving experience both comfortable and unique. You'll find an impressive attention to detail in everything from the luxurious leather seating to our optional customised stitching, which means that every journey you make will be a personal one.

# Engine

## Diesel

We introduced TDI® to the roads in 1989, and since then, we've continuously refined it, including developing common-rail technology. Under this system, a series of piezo injectors use electrical charge to precisely control the amount of fuel injected into the engine. As well as reducing noise, this allows combustion to happen at a lower temperature, with less oxygen, which lowers emissions. The recently introduced bi-turbo diesel engine is our most powerful 6-cylinder diesel engine to date, capable of 313PS and an impressive combined mpg of 44.1.







## Transmissions

### **S tronic®**

Driving is all about thinking ahead, which is just what the S tronic® dual-clutch transmission does. It works almost as two separate systems, one engaging the odd-numbered and the other the even-numbered gears. So when you're accelerating in second, it has third gear waiting for you. And once you make the switch, it's already thinking about fourth. With two clutches working together, you can change gears almost instantly while experiencing smooth, uninterrupted power.

### **tiptronic**

The 8-speed tiptronic transmission system is a form of automatic transmission available on Audi models with quattro® permanent all-wheel-drive. The technology converts high-torque engine power into both sporty performance and operating convenience, with crisp, fast gear changes, reduced weight and an optimised gear-shift strategy. More spontaneous gear changes are a particular benefit, especially when downshifting. Both in the 'D' (Drive) and 'S' (Sport) programme, the advanced electronics used in tiptronic respond efficiently to every driver input, helping to prevent unwanted upshifts when cornering.

## Efficiency

At Audi, doing less is something we're trying to do more of. We're working to use less fuel, release less CO<sub>2</sub> and waste less energy. It's why we've incorporated a number of more efficient technologies into the Audi A6 allroad.

### Recuperation

When a vehicle brakes, the discs convert the kinetic energy into thermal energy, which is wasted as it cannot be used. With a recuperation system, like the one in the Audi A6 allroad, the kinetic energy is converted into useful electrical energy. The way it works is simple. While the car is coasting or braking, the alternator voltage is raised above the level of the basic electrical system, which enables the alternator to generate electrical energy and store it temporarily in the battery. When the vehicle accelerates, this energy is used to relieve the load on the alternator, resulting in a fuel saving of up to 3%.

### Automatic Start-Stop function

In heavy traffic, your car still uses fuel and releases CO<sub>2</sub>, even when it's stationary. The automatic Start-Stop function counteracts this problem by switching off the engine when your car comes to a standstill. As soon as you touch the clutch, the car restarts. In conjunction with TDI® and TFSI®, it helps save up to 0.4 litres of fuel every 100km.







### **Lightweight construction**

From the earliest stages of its design, we looked for ways to save energy in the Audi A6 allroad. It's why every component has been optimised for greater agility, improved efficiency and more driving pleasure. In fact, thanks to its hybrid aluminium construction, this advanced model is now approximately 15% lighter than a conventional steel vehicle.

### **Efficiency programmes**

The Driver's Information System in the Audi A6 allroad comes as standard with an innovative efficiency programme, which offers advice on improving fuel economy as you drive. Also, via the standard Audi drive select system, you can choose a new efficiency setting which aids you in driving even more economically. For more details, see page 20.

### **Aerodynamics**

A car's shape can have a big impact on its efficiency. It's why we've worked to make the Audi A6 allroad as aerodynamic as possible, including technology such as adaptive air suspension that responds to changes in speed. It means that the Audi A6 allroad becomes more aerodynamic at high speeds, while still offering good ground clearance in off-road situations.

## quattro®

It's the technology that has given Audi the edge on the rally circuit ever since it was first introduced over 30 years ago – a technology that delivers ultimate control whilst enhancing the sporty characteristics which make the A6 allroad so thrilling to drive. It's called quattro® permanent all-wheel-drive. The principle is simple: in the same way that four brakes ensure better deceleration, four permanently-driven wheels deliver better acceleration and road-holding, pushing or pulling the car as needed, for a driving experience that's both dynamic and safe.

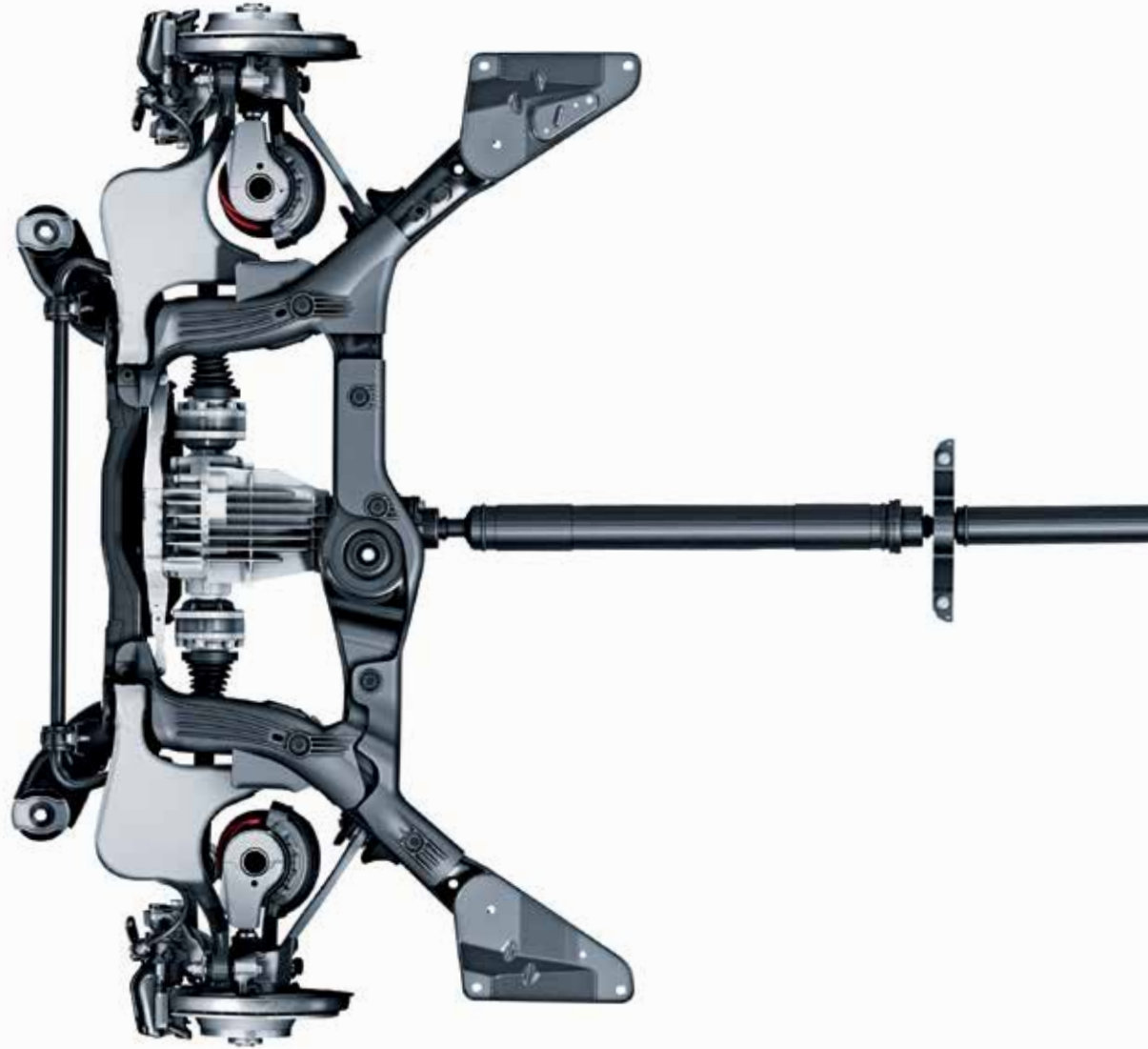

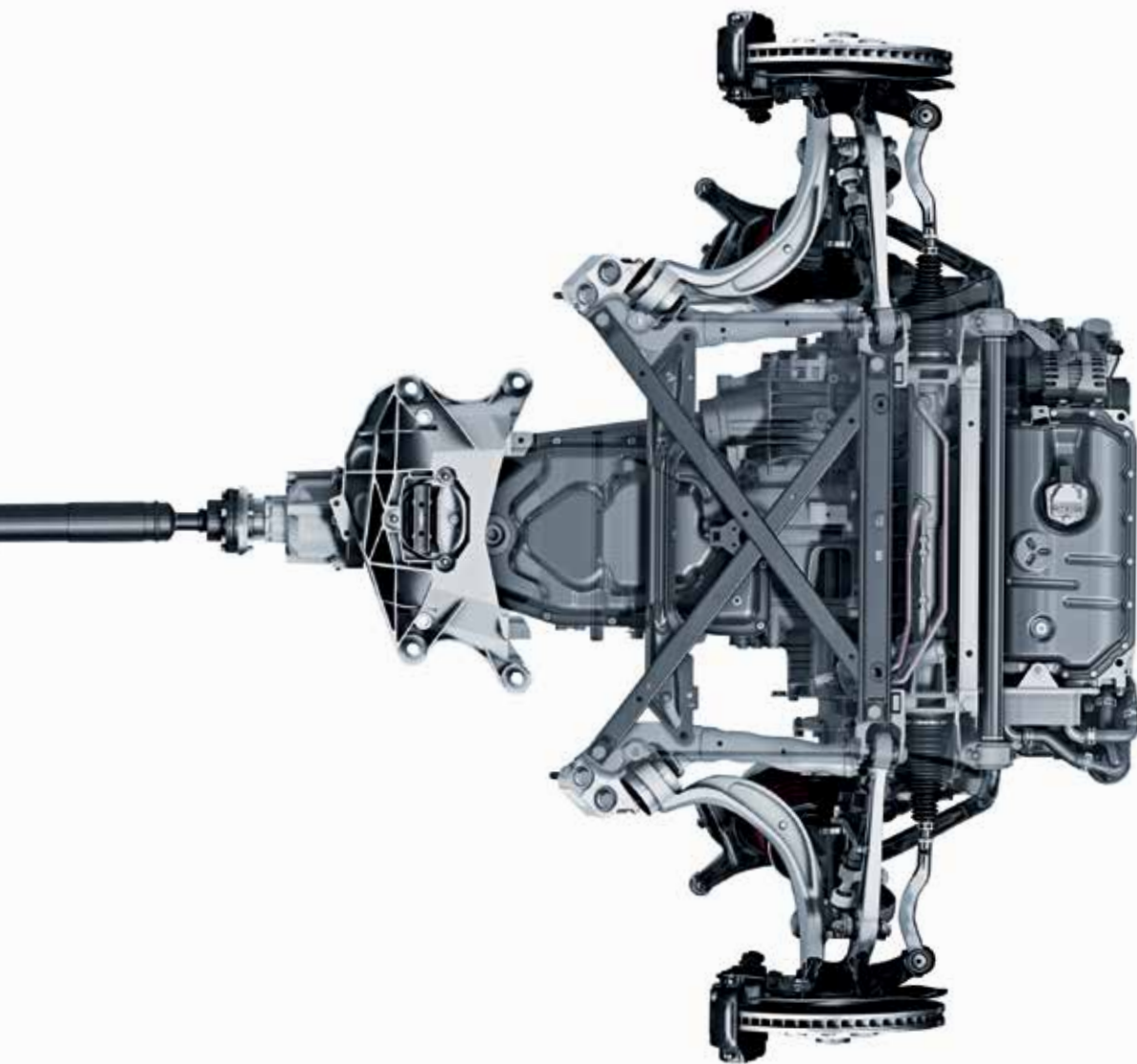

In the Audi A6 allroad, asymmetric dynamic torque distribution continuously distributes drive power between the front and rear axles, depending on weather conditions, road surface and gradient. This leads to greater flexibility and an enhanced, sportier drive. It means that the Audi A6 allroad can 'read' the road, sensing changes in the surface beneath the wheels and adjusting their grip accordingly. So when conditions get a little more demanding – in particular, when you go off-road – quattro® adapts, putting all the force of the Audi A6 allroad's engine precisely where it's needed to handle the change in terrain.

### **quattro® with Sports differential**

The optional electronically regulated Sports differential distributes variable amounts of drive force to each rear wheel, ensuring outstanding acceleration performance in corners and stabilising the vehicle's response to load change. It also brings better direct steering characteristics and, as it requires less steering effort, more agile handling.











# Standard model equipment

All A6 allroad models have the following items of standard equipment

## Engine and transmission

Start-Stop system with energy recuperation

## Wheels, tyres and suspension

18" x 8J '5-arm' design alloy wheels with 235/55 R18 tyres

## Electromechanical parking brake

Adaptive air suspension – the driver can choose between automatic suspension and three further suspension settings which are accessed via the MMI: Comfort, Dynamic and Lift. There is also a trailer and jack mode, and specifically for the A6 allroad there is an off-road setting

Audi drive select – with four pre-configured modes (Comfort, Auto, Dynamic and Efficiency), and a further Individual mode allowing the driver to electronically adjust the engine, transmission and steering. The new efficiency mode influences the shift programme, electromechanical power steering, engine, cruise control, and, where fitted, deluxe automatic air conditioner, adaptive air suspension and quattro® with Sports differential

## Collapsible spare wheel

## Anti-theft wheel bolts

Tool kit and car jack

## Safety and security

Driver's Information System (DIS) – monochrome display in the direct field of view of the driver. The DIS shows the radio frequency/station or the song title, outside temperature, trip computer, gear-shift display, telephone menu and a rest recommendation feature which visually and acoustically alerts the driver to take a break when getting tired

Cruise control – maintains any speed above 18mph, provided the engine power output and engine braking effect permit it; operated via separate steering column stalk. The set speed is displayed in the Driver's Information System

Light and rain sensor – automatically switches the dipped beam or windscreen wipers on/off depending on the light and rain conditions; includes delayed deactivation/automatic activation of the rear lights and number plate lights when parking or opening the vehicle

Hill-hold assist – holds the vehicle stationary for unlimited periods after stopping on upward and downward slopes

Audi parking system plus – acoustic and visual park assist system for the front and rear with Multi-Media Interface (MMI) screen display; measurement is by ultrasonic sensors concealed in the bumpers

Tyre pressure monitoring display – provides a visual and acoustic warning of loss in pressure in one or more tyres; defective tyre is displayed in the Driver's Information System

## Electronic Stability Control (ESC)

## First aid kit with warning triangle

Front airbags with front passenger deactivation – also includes side head airbags

## Seat belt monitoring

Anti-theft alarm – with tow-away protection via angle of inclination sensors (can be switched off), including interior monitoring system which can be switched off; alarm for monitoring doors, bonnet and tailgate, independent of vehicle electrical system

Keyless go – conveniently allows the engine to be started by simply pressing the start-stop button in the centre console. The key just needs to be carried



3-spoke leather trimmed multi-function steering wheel with paddles



Aluminium door sill trims with allroad logo



Dual-zone electronic climate control



18" x 8J '5-arm' design alloy wheels



## Seats

### Split-folding rear seat backs

**Standard seats in Milano leather upholstery** – including seat covers, head restraints and front centre armrest. The leather is hard-wearing and durable. Includes manual adjustment for seat height, length, backrest angle, head restraint, belt height and steering wheel reach and height

**ISOFIX child seat mounting** – for front passenger (with airbag deactivation) and outer rear seats

## Audio and communication

### MMI Radio Plus including:

- MMI control panel operating the MMI display (6.5" retractable colour display)
- 2 SDHC memory card readers (up to 32GB) and single CD player that supports MP3, WMA and AAC
- TP memo – automatically saves traffic news when driving

**DAB digital radio reception** – receives programmes from digital radio transmitters in addition to the range of analogue stations with better sound quality. With the DAB twin tuner, a second DAB tuner permanently searches for alternative reception frequencies of the set station, and the station list is updated at the same time. Please note – reception depends on local digital network availability. When in combination with MMI Navigation Plus (PNQ/WB4/WB7) it is also capable of receiving DAB+ and DMB audio signals

### MMI Navigation (SD card) including:

- 6.5" retractable MMI colour display with high quality map display including 7-digit postcode recognition
- Voice control using whole words
- Dynamic route guidance
- Additional display in the Driver's Information System

### Audi sound system

- 6-channel amplifier
- 180-watt amplifying capacity
- 10 loudspeakers including subwoofer

### AUX-IN socket

**Mobile telephone preparation – Bluetooth interface** – Bluetooth-compatible mobile phones can be connected to the vehicle via the interface, allowing handsfree calls via the microphone

## Interior equipment

**Dual-zone electronic climate control** – automatic air conditioning which electronically regulates the air temperature, air flow rate and distribution for the driver and front passenger sides

### 3-spoke leather trimmed multi-function steering wheel with paddles

**Auto-dimming rear-view mirror** – uses a photocell to recognise when the headlights behind are too bright and dims automatically

**Front centre armrest** – for driver and front passenger, movable and with adjustable angle

### Cloth headlining

### Luggage compartment system comprising:

- Rail luggage fixing system
- Dirt-resistant tray
- Double cargo floor
- Lashing points, side restraining straps and bag hooks

### Storage package comprising:

- 2 x drinks holders in the rear centre armrest
- 2 x 12-Volt sockets in the rear
- Luggage net

### Inlays in aluminium delta

### Aluminium door sill trims with allroad logo

### Front and rear floor mats in black velour

## Exterior equipment

**Exterior mirrors** – electrically adjustable and heated

### Halogen headlights with headlight washer system

### Body-coloured door mirrors

### Aluminium optic package comprising:

- Aluminium roof rails
- Window capping strips in aluminium
- Door handles with aluminium-look trim

### Body-coloured roof spoiler

**Tow bar bracket preparation** – the set of parts for retrofitting is available from Audi Accessories (see page 69) or available as an option (see page 58)

**Power-operated boot lid** – opening via the remote control key, and when ordered in combination with the Advanced key (4F2) the boot lid will also close remotely. Opening and closing is also possible using the button in the driver's door panel or the soft touch button on the tailgate. Includes a programmable tailgate opening angle and electrically operated luggage area cover. When the boot lid is opened the luggage cover is automatically drawn back along its rails and then returns when the boot lid is closed





Image shows the A6 allroad model with optional Moonlight blue, metallic paint (W1), All-LED headlights including high-beam assist (PX2) and Adaptive cruise control with Stop&Go function including pre-sense front (PCG)





## A6 allroad

Engines	Power	Transmissions	CO <sub>2</sub> g/km	Basic RRP	Total RRP inc VAT	Recommended OTR
3.0 TDI quattro	204PS	7-speed S tronic	159	£35,820.83	£42,985.00	£43,805.00
3.0 TDI quattro	245PS	7-speed S tronic	165	£37,104.17	£44,525.00	£45,345.00
3.0 BiTDI quattro	313PS	8-speed tiptronic	176	£40,937.50	£49,125.00	£50,105.00

**Please note:** The maximum power output figures are quoted in PS (or Pferdestärke, which is the metric equivalent of brake horsepower). To convert to brake horsepower, divide the PS figure by 1.0139.

**Recommended On-The-Road (OTR) retail prices include:** delivery charge, half a tank of fuel, number plates at £590.00 (inc. VAT), Road Fund Licence (which may vary depending on model/transmission – see page 75 for details) and first registration fee at £55.00. Vehicle Excise Duty correct at time of going to print, but this may alter to reflect any change in the applicable VED rate.

RRP – Recommended Retail Price. VAT is calculated at 20% but this may alter to reflect any change in the applicable VAT rate.







Front Sports seats (PS1). Audi exclusive leather equipment and trim package 2 in Valcona leather (PYR) in Havanna brown/Alabaster white. Audi exclusive inlay (YTA) in Tamo ash natural dark brown. Audi exclusive controls package (YRB) in Havanna brown. Audi exclusive seat belts (YTO) in Alabaster white.



## Audi exclusive

Every Audi is intrinsically exclusive. It's the breathtaking design, the exceptional engineering, the Vorsprung durch Technik. But for that special touch you can specify your new A6 allroad with options from Audi exclusive. Whether you want a unique, custom-mixed paint colour or seats in a combination of complementary shades, Audi exclusive will enable you to drive the car you've always imagined.

Both the exclusive and standard options can be found on the following pages.



# Paint

We believe that every part of your car should have a personal touch – which is why you can choose from a wide range of paint colours and finishes, from standard shades to metallic and pearl effects. We can even mix a customised colour for you to create the perfect fit.

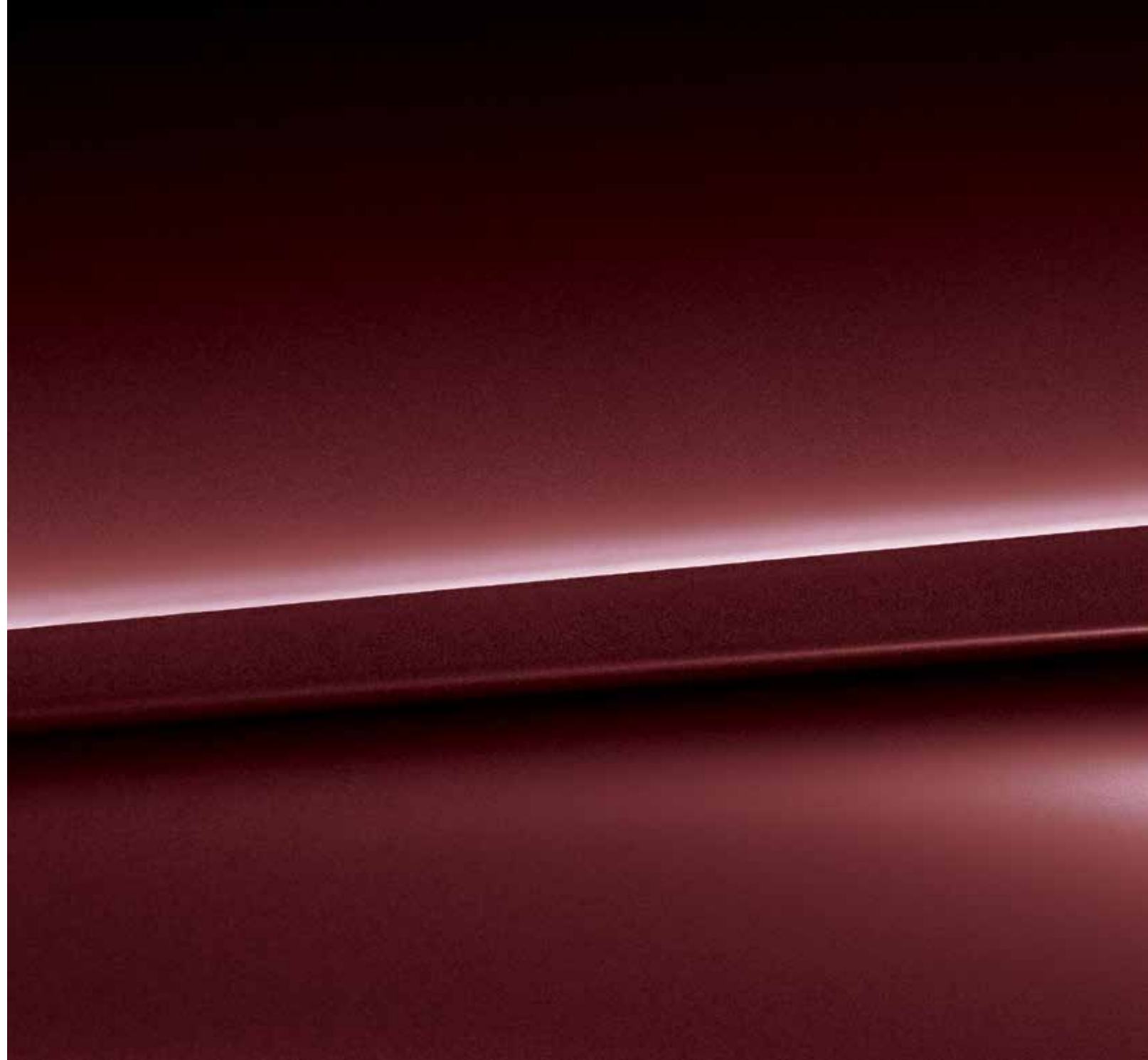

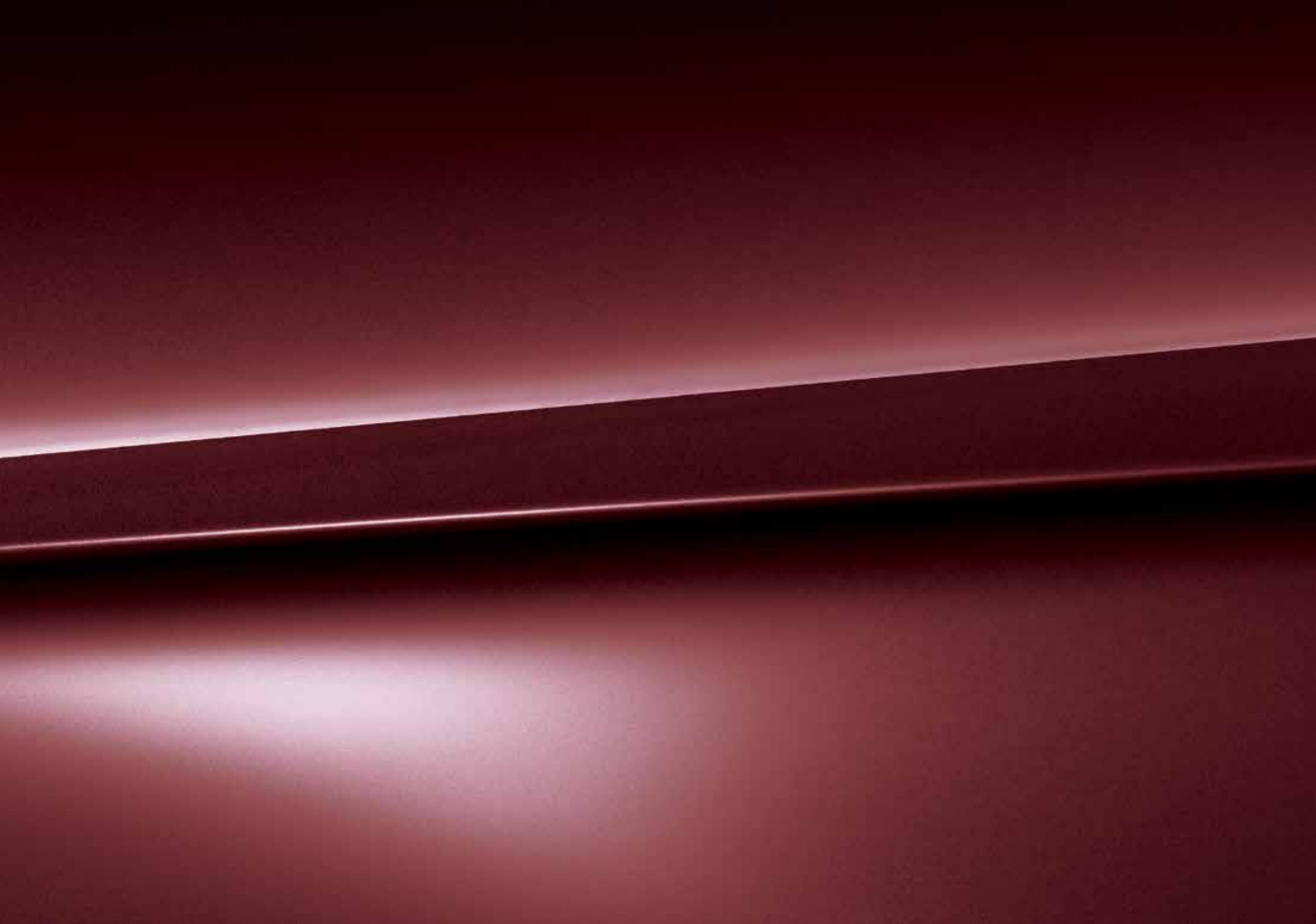



# Paint

## Standard and optional colours

You can select one of the standard colours shown opposite or, for a different look, choose from a range of optional finishes.

Options are subject to availability and may extend delivery.

All the colour swatches on this page are matched as accurately as possible to the actual paint colours used. However, due to print processes, Audi UK cannot guarantee that colours shown are 100% accurate.

Visit your local Audi Centre for a more accurate colour swatch.

Please note all exterior colours come with Anthracite metallic contrast bumpers however, Ice silver and Dakota grey come with Soul black contrast bumpers.

\*These colours are not available in combination with full paint finish.

RRP – Recommended Retail Price.

VAT is calculated at 20% but this may alter to reflect any change in the applicable VAT rate.

### Standard colours



Ibis white – T9\*

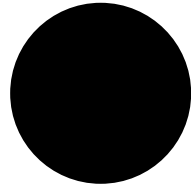

Brilliant black – A2\*

### Optional colours

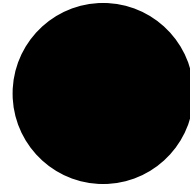

Phantom black, pearl effect – L8

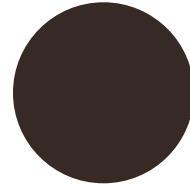

Java brown, metallic – 0Y

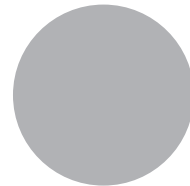

Ice silver, metallic – P5

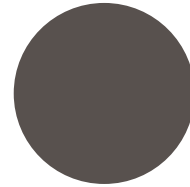

Dakota grey, metallic – Y7

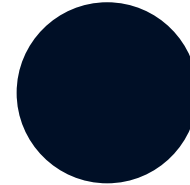

Moonlight blue, metallic – W1

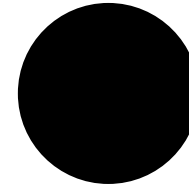

Havannah black, metallic – 4J

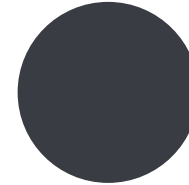

Oolong grey, metallic – 4N

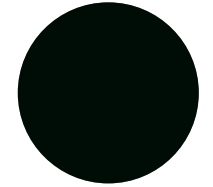

Deep green, pearl effect – 3W



Glacier white, metallic – 2Y

### Optional colours

**Basic RRP**

£545.83

**Total RRP inc VAT**

£655.00

# Paint

## Audi exclusive

Everyone has a favourite colour. No matter what yours is, Audi exclusive provides a range of unique colours that have been designed to set your car apart. Choose from the swatches here, or specify any other paint colour in the Audi range – whether it's Sepang blue from the Audi R8 or Alpine white from the original Audi quattro. The choice is yours.

## Customised

If you have a particular colour in mind, we'll mix the exact metallic or pearl-effect shade you want.\*

Options are subject to availability and may extend delivery.

Audi exclusive paints are not available in combination with full paint finish.

\*Customised paint is subject to factory approval, and is available for metallic and pearl-effect water-based paints only. Three-colour process colours and two-tone schemes are not available.

\*\*Visit your local Audi Centre for colour samples.

All the colour swatches on this page are matched as accurately as possible to the actual paint colours used. However, due to print processes, Audi UK cannot guarantee that colours shown are 100% accurate.

Visit your local Audi Centre for a more accurate colour swatch.

RRP – Recommended Retail Price.

VAT is calculated at 20% but this may alter to reflect any change in the applicable VAT rate.

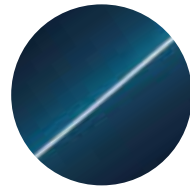

Palace blue, pearl effect

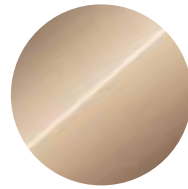

Sand beige, pearl effect

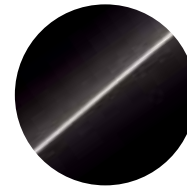

Saddle brown, pearl effect

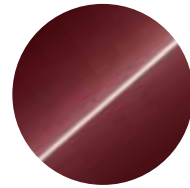

Classic red, pearl effect

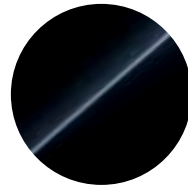

Mamba black, metallic

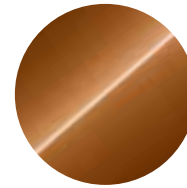

Ipanema brown, metallic



Any colour in the Audi range or 100 exclusive colours to choose from\*\*



Customised paint

### Audi exclusive

**Basic RRP**  
£1,795.83

---

**Total RRP inc VAT**  
£2,155.00

### Customised\*

**Basic RRP**  
£2,212.50

---

**Total RRP inc VAT**  
£2,655.00

## Upholstery

It's important to feel comfortable on the road. Just choose from our range of luxury upholstery materials and textures, including additional support and colour options, for complete relaxation while you drive.







# Upholstery

## Standard seats

Standard seats are manually adjustable for head restraint height or clearance, belt height, backrest angle, seat height and forwards and backwards seat position. To further enhance your comfort you can also add electric lumbar support and seat heating.

Choose your favourite upholstery from the swatches shown opposite to give your car's interior the look and feel you want.

Options are subject to availability and may extend delivery.

- = Available
- = Not available
- S = Standard

All leather upholstery choices include seats, head restraints, door inserts and front centre armrest in leather.

RRP – Recommended Retail Price.

VAT is calculated at 20% but this may alter to reflect any change in the applicable VAT rate.

Milano leather  
– NSW

 <p>Black – FZ</p>	A6 allroad	Basic RRP	Total RRP inc VAT
	S	No charge	No charge

**Milano leather.** Seat covers, head restraints and front centre armrest in Milano leather, which is fully penetrated with dye and lacquered for excellent surface protection. The leather is extremely hard-wearing and durable, tanned without using chromium and gives a high-quality impression with its fine-grained surface

Valcona leather  
– NSW

 <p>Black – FZ</p>	A6 allroad	Basic RRP	Total RRP inc VAT
	•	£416.67	£500.00

**Valcona leather.** Seat covers, head restraints, door trims and front centre armrest in Valcona leather, a high-quality material which contributes to the elegance of the interior. A lacquered surface allows the material to breathe whilst the non-grained surface underlines the luxury of the A6 allroad. Valcona leather is tanned without using chromium, dyed and uses non-fading colour pigments

# Upholstery

## Comfort seats – PS8

Comfort seats offer a multitude of electrical or pneumatic adjustment options with memory function for both front seats and exterior mirrors.

Electrically adjustable:

- Backrest angle, seat height, seat rake, forward and backward position and thigh support

Manually adjustable:

- Head restraint height/clearance and belt height

Pneumatically adjustable:

- Lumbar support, backrest side sections and seat-side sections

Choose your favourite upholstery from the swatches shown opposite to give your car's interior the look and feel you want.

Options are subject to availability and may extend delivery.

\*Valcona leather (N5D) is only available in combination with seat ventilation (4D3/4DB), seat heating (4A3/4A4) and Deluxe 4-zone climate control (9AQ).

- = Not available
- = Available
- S = Standard

RRP – Recommended Retail Price.

VAT is calculated at 20% but this may alter to reflect any change in the applicable VAT rate.

Milano leather  
– N5W

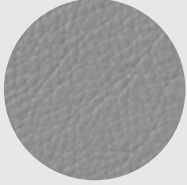
					
Black – FZ	Titanium grey – VZ	Velvet beige – XE			
			•	£1,420.83	£1,705.00

**Milano leather.** Seat covers, head restraints and front centre armrest in Milano leather, which is fully penetrated with dye and lacquered for excellent surface protection. The leather is extremely hard-wearing and durable, tanned without using chromium and gives a high-quality impression with its fine, grained surface

Valcona leather\*  
– N5D

					
Black – FZ	Titanium grey – VZ	Velvet beige – XE	Santos brown – VY		
				•	£1,837.50
					£2,205.00





**Valcona leather.** Seat covers, head restraints, door trims and front centre armrest in Valcona leather, a high-quality material which contributes to the elegance of the interior. A lacquered surface allows the material to breathe whilst the non-grained surface underlines the luxury of the A6 allroad. Valcona leather is tanned without using chromium, dyed and uses non-fading colour pigments\*



# Upholstery

## Front Sports seats – PS1

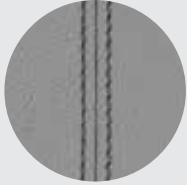
Front Sports seats include 4-way electric lumbar support and manual height adjustment.

				A6 allroad	Basic RRP	Total RRP inc VAT
Milano leather – N5W		Black – VV		•	£554.17	£665.00
Leather/Alcantara – N7U		Black – FZ*		•	£554.17	£665.00
Valcona leather – N5D		Black – VV				
		Titanium grey – VU				
		Velvet beige – VW				
		Santos brown – VT		•	£970.83	£1,165.00

Options are subject to availability and may extend delivery.

- = Available
- = Not available
- S = Standard

\*Leather/Alcantara (N7U) is only available in combination with seat heating (4A3/4A4).

All leather upholstery choices include seats, head restraints, door inserts and front centre armrest in leather.

RRP – Recommended Retail Price.

VAT is calculated at 20% but this may alter to reflect any change in the applicable VAT rate.

# Seats

Choose from a variety of different seat options so you can maintain the correct driving posture at all times.

Order Code		A6 allroad	Basic RRP	Total RRP inc VAT
4A3	<b>Heated front seats.</b> Individually controlled variable temperature adjustment. Only available in combination with lumbar support (7P1)	●	£250.00	£300.00
4A4	<b>Heated front and rear seats.</b> Individually controlled variable temperature adjustment. Only available in combination with deluxe 4-zone climate control (9AQ) and lumbar support (7P1)	●	£366.67	£440.00
7P1	<b>Electric lumbar support.</b> For front seats with horizontal and vertical adjustment	●	£245.83	£295.00
PV3	<b>Electric front seats with driver's seat memory.</b> Includes adjustment for height, forwards and backwards position, backrest angle and lumbar support. Also includes memory for door mirrors and electrically adjusted steering column, if fitted. Only available in combination with memory mirrors (6XF/6XG/6XL/6XM)	●	£766.67	£920.00
4D3	<b>Seat ventilation for front seats.</b> 3 different intensities of cool air drawn through the seat for active ventilation of the seat-centre section and thigh support. To allow for the seat ventilation, the leather of the seat front is perforated. Only available in combination with electric seats (PV3/PS8), seat heating (4A3/4A4) and deluxe 4-zone climate control (9AQ). When ordered in combination with comfort seats (PS8) this must be ordered with Valcona leather (N5D) and deluxe 4-zone climate control (9AQ). Not available in combination with front sports seats (PS1)	●	£700.00	£840.00
4D8	<b>Massage and seat ventilation for front seats.</b> Massage function with 5 different programmes (wave, pulse, stretch, lumbar, shoulders) and four levels of intensity for massaging the muscles with the help of 10 pneumatic cushions. Ventilation with 3 different intensities of cool air drawn through the seat for active ventilation of the seat-centre section and thigh support. To allow for the seat ventilation, the leather of the seat front is perforated. Only available in combination with comfort seats (PS8), Valcona leather (N5D), deluxe 4-zone climate control (9AQ), seat heating (4A3/4A4) and memory mirrors (6XF/6XG/6XL/6XM)	●	£1,385.33	£1,630.00

Options are subject to availability and may extend delivery.

- = Available
- = Not available
- S = Standard

RRP – Recommended Retail Price.

VAT is calculated at 20% but this may alter to reflect any change in the applicable VAT rate.

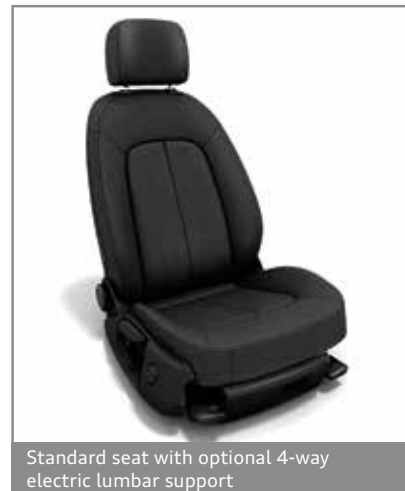

# Colour and trim guide

## Interior trim colours

### Standard seats

To help you choose the right interior for your new Audi A6 allroad, please use this guide, showing the carpet, dashboard and headlining colours that have been matched to your chosen upholstery.

### Comfort seats – PS8

### Sports seats – PS1

Options are subject to availability and may extend delivery.

- = Available
- = Not available
- S = Standard

\*Please note that floor mats (OTX) are not standard – they are a no-cost option, see page 57 for more information. If these are not chosen, the front and rear floor mats for all interior trims will be black velour

Order Code	Upholstery (seat centre/seat bolster/stitching)	Carpet	Floor mats (OTX)*	Dashboard (upper/lower)	Headlining	Milano leather (N5W)	Valcona leather (N5D)
<b>FZ</b>	Black/Black/Black	Black	Black/Brown	Black/Black	Lunar silver	●	●

Order Code	Upholstery (seat centre/seat bolster/stitching)	Carpet	Floor mats (OTX)*	Dashboard (upper/lower)	Headlining	Milano leather (N5W)	Valcona leather (N5D)
<b>FZ</b>	Black/Black/Black	Black	Black/Brown	Black/Black	Lunar silver	●	●
<b>VY</b>	Santos brown/Santos brown/Black	Black	Black/Brown	Black/Black	Lunar silver	–	●
<b>VZ</b>	Titanium grey/Titanium grey/Black	Black	Black/Grey	Black/Black	Lunar silver	●	●
<b>XE</b>	Velvet beige/Velvet beige/Black	Black	Black/Beige	Black/Black	Silk beige	●	●

Order Code	Upholstery (seat centre/seat bolster/stitching)	Carpet	Floor mats (OTX)*	Dashboard (upper/lower)	Headlining	Milano leather (N5W)	Leather/Alcantara (N7U)	Valcona leather (N5D)
<b>FZ</b>	Black/Black/Black	Black	Black/Brown	Black/Black	Lunar silver	–	●	–
<b>VV</b>	Black/Black/Santos brown	Black	Black/Brown	Black/Black	Lunar silver	●	–	●
<b>VT</b>	Santos brown/Santos brown/Anthracite	Black	Black/Brown	Black/Black	Lunar silver	–	–	●
<b>VU</b>	Titanium grey/Titanium grey/Graphite grey	Black	Black/Grey	Black/Black	Lunar silver	–	–	●
<b>VW</b>	Velvet beige/Velvet beige/Graphite grey	Black	Black/Beige	Black/Black	Silk beige	–	–	●





# Upholstery

## Audi exclusive

With Audi exclusive, you can specify your seats in Fine Nappa leather, leather/Alcantara or Valcona leather, from an array of different colours shown to the right.

Select just one all-over shade for each seat, or customise each panel in two or more complementary colours from the distinctive Audi exclusive palette. You can even choose the colour of the decorative stitching – to match or contrast with your chosen upholstery – from this varied collection. Whatever combination you decide upon, we think you'll be extremely comfortable with the result.



Chestnut brown



Jet grey



Alabaster white

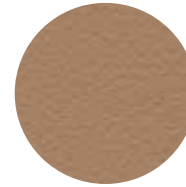

Sand beige

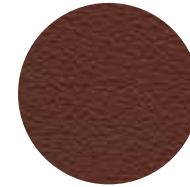

Saddle brown

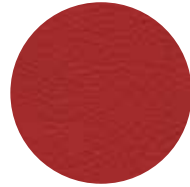

Crimson red



Magnolia white



Havanna brown

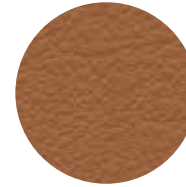

Cognac brown

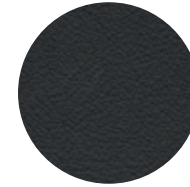

Night blue



Cloudy grey

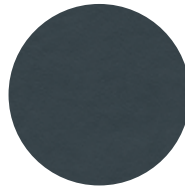

Smoky blue

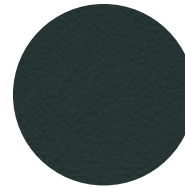

Iceland green



Powder beige

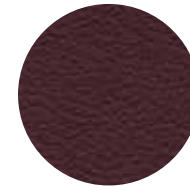

Classic red

### Also available:

**Alcantara colours:** available in all the Audi exclusive colours shown, except for Crimson red and Sand beige. Alcantara equivalents are Chilli red and Sesame beige respectively.

Please consult your Audi Centre for examples of Alcantara and carpet colours.

# Upholstery and equipment

## Audi exclusive

Order Code		A6 allroad	Basic RRP	Total RRP inc VAT
PYB S3G	<b>Audi exclusive leather package 1 in Valcona leather.*</b> Includes seat upholstery, door trim inserts, head restraints, centre armrest and lower centre console. Only available in combination with 4-way lumbar support (7P1)	●	£4,166.67	£5,000.00
PYC S3G	<b>Audi exclusive leather package 1 in Valcona leather/Alcantara.*</b> Includes seat upholstery, head restraints, centre armrest and lower centre console in Valcona leather. Seat centre section and door trim inserts in Alcantara. Only available in combination with Sports seats (PS1)	●	£4,166.67	£5,000.00
PYR S3G	<b>Audi exclusive leather package 2 in Valcona leather.*</b> Includes all the contents of leather package 1 plus leather-covered seat backrest covers, door armrests and handles. Seat-side trims and add-on parts are colour coordinated	●	£7,225.00	£8,670.00
YTO S3G	<b>Audi exclusive seat belts</b>	●	£1,375.00	£1,650.00
YSQ S3G	<b>Audi exclusive carpets.*</b> Includes front and rear floor mats	●	£1,750.00	£2,100.00
YRB S3G	<b>Audi exclusive controls package.*</b> Includes steering wheel rim and selector lever in leather. Not available in combination with Audi exclusive leather steering wheel rim (YRH)	●	£695.83	£835.00
6Q3	<b>Gear selector lever with wood segments.</b> Only available in combination with Walnut dark brown inlays (SMG)	●	£95.83	£115.00
6F9	<b>Steering wheel in wood segments.</b> Not available in combination with Audi exclusive inlays or Audi lane assist. Only available in combination with leather covered multi-function steering wheel in 4-spoke design with paddles (Z2S) and Walnut brown inlays (SMG)	●	£508.33	£610.00
YTD S3G	<b>Audi exclusive selector lever with wood segment.</b> Selector lever knob customised with Audi exclusive woods (excluding Tamo ash dark brown). Only available in combination with Audi exclusive inlays (YTA - excluding Tamo ash dark brown)	●	£279.17	£335.00
YRI S3G	<b>Audi exclusive part-wood part-leather steering wheel.</b> Only available in combination with leather covered multi-function steering wheel in 4-spoke design with paddles (Z2S), and Audi exclusive inlays (YTA - excluding Tamo ash dark brown)	●	£908.33	£1,090.00
YRH S3G	<b>Audi exclusive steering wheel.</b> Not available in combination with Audi exclusive controls pack (YRB)	●	£454.17	£545.00

Options are subject to availability and may extend delivery.

- = Available
- = Not available
- S = Standard

\*Leather and stitching colours (where applicable) can be specified in a variety of colours from the Audi exclusive range.

RRP – Recommended Retail Price.

VAT is calculated at 20% but this may alter to reflect any change in the applicable VAT rate.



## Inlays

Attention to detail can make a big impact. From contemporary Piano black finish to a Walnut brown, our selection of inlays offers the perfect finishing touch to your car's interior.





# Inlays

Inlays are the all-important finishing touch that add flair and interest to your car's interior.

Order Code		A6 allroad	Basic RRP	Total RRP inc VAT
7TH	Aluminium delta	S	No charge	No charge
5MG	Walnut, dark brown	●	£287.50	£345.00
5MT	Oakwood, beaufort	●	£583.33	£700.00
7TL	Fine grain ash, natural brown	●	£287.50	£345.00
5TL	Piano finish, black	●	£583.33	£700.00
5TB	Aluminium, beaufort black	●	£1,291.67	£1,550.00

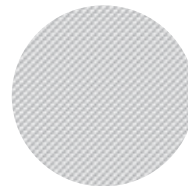

Aluminium delta - 7TH



Walnut, dark brown - 5MG

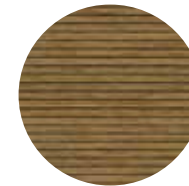

Oakwood, beaufort - 5MT



Fine grain ash, natural brown - 7TL

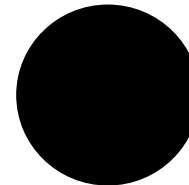

Piano finish, black - 5TL



Aluminium, beaufort black - 5TB

Options are subject to availability and may extend delivery.

- = Available
- = Not available
- S = Standard

RRP - Recommended Retail Price.

VAT is calculated at 20% but this may alter to reflect any change in the applicable VAT rate.



# Inlays

## Audi exclusive

Audi exclusive has sourced a wide range of materials from which you can select for your inlays, from Oak sepia to Fine grain myrtle.

Order Code		A6 allroad	Basic RRP	Total RRP inc VAT
YTA S3G	Audi exclusive inlays (cannot be combined with the inlays shown on page 44)	●	£1,083.33	£1,300.00



Tamo ash, natural dark brown



Modrone wood, gold

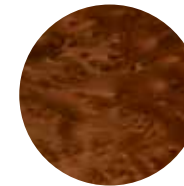

Vavona wood, bronze



Fine grain ash, nougat



Fine grain myrtle, nutmeg



Oak, sepia

Options are subject to availability and may extend delivery.

- = Available
- = Not available
- S = Standard

RRP – Recommended Retail Price.

VAT is calculated at 20% but this may alter to reflect any change in the applicable VAT rate.

## Options

Every driver has different needs, which is why we have created some useful options to further enhance your car. For extra comfort, support, style or function, you can choose from a variety of additional features, tailoring everything from your infotainment and audio equipment to your wheels and lighting.







# Wheels and tyres

Choose a set of specially selected alloy wheels to subtly enhance the way your car looks and drives.

Order Code		A6 allroad	Basic RRP	Total RRP inc VAT
<b>C1Q</b>	<b>18" x 8J '5-arm' design alloy wheels with 235/55 R18 tyres</b>	S	No charge	No charge
<b>PRK</b>	<b>19" x 8.5J '10-spoke' design alloy wheels with 255/45 R19 tyres</b>	●	£1,066.67	£1,280.00
<b>PRP</b>	<b>20" x 8.5J '5-parallel-spoke' design alloy wheels with 255/40 R20 tyres</b>	●	£2,037.50	£2,445.00
<b>GH2</b>	<b>quattro with Sports differential.</b> The electronically regulated Sports differential distributes variable amounts of driving force to each rear wheel, ensuring outstanding acceleration performance in corners and stabilising the vehicle's response to load change. It also ensures better direct steering characteristics and, thanks to less steering effort, more agile handling. Please note this is not available on the 3.0 TDI 204PS	●	£916.67	£1,100.00
<b>1N8</b>	<b>Dynamic steering.</b> Improves comfort and handling by dynamically regulating steering according to the driving situation. With this technology, driving is significantly more agile under everyday conditions, while directional stability and precision are increased at high speeds and in demanding driving situations	●	£1,000.00	£1,200.00



18" x 8J '5-arm' design alloy wheels with 235/55 R18 tyres – C1Q



19" x 8.5J '10-spoke' design alloy wheels with 245/45 R19 tyres – PRK



20" x 8.5J '5-parallel-spoke' design alloy wheels with 255/40 R20 tyres – PRP

Options are subject to availability and may extend delivery.

● = Available  
 – = Not available  
 S = Standard

RRP – Recommended Retail Price.

VAT is calculated at 20% but this may alter to reflect any change in the applicable VAT rate.



# Packages

Some items work well together, which is why we've created these special packages. They provide increased convenience and value by combining several of our most popular options.

Order Code	A6 allroad	Basic RRP	Total RRP inc VAT
<b>WB4</b> <b>Technology package</b> Featuring MMI Navigation Plus with MMI Touch, colour Driver's Information System (DIS), mobile telephone preparation – High with Audi connect and Audi Music Interface <b>MMI Navigation Plus (PNQ)</b> – includes HDD-based Navigation with topographical map display, places of interest and town models in 3D. Destinations can be entered via the speech dialogue system or MMI Touch, including 7-digit postcode recognition. Also includes DVD player and 2 SDHC memory card readers <b>Driver's Information System (DIS) with 7" colour display (9Q8)</b> – high-resolution TFT colour 7" display in direct field of view of the driver. Shows information from driver assistance systems, media in use, telephone menu, gear, outside temperature and other display content of the MMI such as night vision assistant (if optionally selected) <b>Mobile telephone preparation – High with Audi connect (9ZW)</b> – Audi connect provides access to a number of innovative online services via an internal UMTS (3G) module. Audi connect online services include: navigation using Google Earth images and Google Street View, destination entry via Google Maps or myAudi, online point of interest search and information services such as weather forecasts and the latest world news. Audi connect can also create a Wi-Fi hotspot in the car for convenient internet access using a mobile device (e.g. laptop or tablet). Please see page 54 for a full description of this option including functionality and compatibility details <b>Audi Music Interface (UF7)</b> – a universal connection for use with stereo audio sources, USB and MP3 devices For more details please see pages 52, 54 and 55	●	£1,250.00	£1,500.00
<b>WB7</b> <b>Technology package advanced</b> Includes all the features of technology package (WB4) as well as Audi adaptive cruise control and the Audi pre-sense plus safety package (PCN) which, in a situation where a collision is inevitable, allows full brake application to avoid or lessen the impact of the collision <b>Audi adaptive cruise control with Stop&amp;Go function including pre-sense front (PCG)</b> – automatic distance regulation, using radar sensors to maintain the required distance between vehicles by braking and accelerating. Works at speeds between 0 and 155mph** <b>Audi side assist including pre-sense rear (PCH)</b> – aids the driver when changing lane. The system monitors the area behind your car, using radar sensors located discreetly in the rear bumper, informing the driver with a visual warning signal in the door mirror if there is a vehicle in their blind spot or approaching quickly from behind <b>Audi active lane assist (PCB)</b> – helps the driver to stay in lane with gentle steering impulses for greater safety and convenience <b>Exterior mirrors (6XE)</b> – heated, electrically adjustable and electrically folding Only available in combination with Xenon or all-LED lights (PXB/PX2) For more details please see pages 58 and 61	●	£2,708.33	£3,250.00

Options are subject to availability and may extend delivery.

- = Not available
- = Available
- S = Standard

RRP – Recommended Retail Price.

\*\*Where the law permits.

VAT is calculated at 20% but this may alter to reflect any change in the applicable VAT rate.



# Packages



MMI Navigation Plus with Google Maps – part of the Technology package



MMI Navigation Plus with MMI Touch – part of the Technology package



Audi adaptive cruise control with Stop&Go function – part of the Technology package advanced

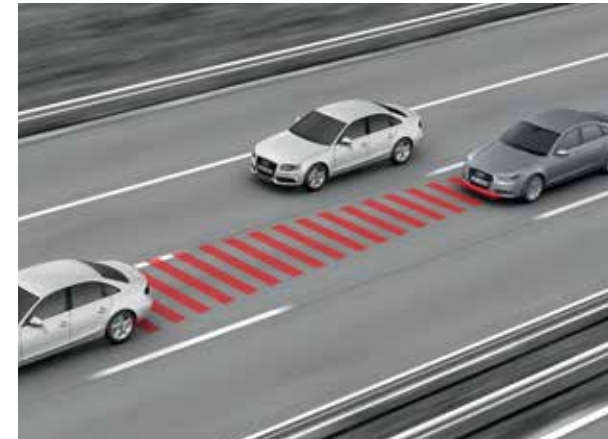

Audi adaptive cruise control with Stop&Go function – part of the Technology package advanced

RRP – Recommended Retail Price.

VAT is calculated at 20% but this may alter to reflect any change in the applicable VAT rate.

# Audio and communication

Stay in touch using our range of communication functions, and give each journey its own soundtrack with our advanced audio equipment.

Order Code		A6 allroad	Basic RRP	Total RRP inc VAT
UF7	<b>Audi Music Interface.</b> Universal connection for use with stereo audio sources, USB and MP3 devices including Apple iPod generation 4 onwards (iPod, iPod classic, iPod mini, iPod nano, iPod photo, iPod video, iPod touch). Provides intuitive control through the audio system and multi-function steering wheel. It also replicates the iPod display on the MMI audio screen and DIS, including track titles. The interface provides charging function (dependent on device). Includes 2 cables to connect your iPod or USB MP3 player device. Please note that this option will replace the standard AUX-IN socket. Also available as part of the technology package (WB4/WB7)	●	£216.67	£260.00
9Q8	<b>Driver's Information System (DIS) with 7" colour display.</b> High-resolution TFT colour 7" display in direct field of view of the driver. Shows information from driver assistance systems, media in use, telephone menu, gear, outside temperature and other display content of the MMI such as night vision assistant (if optionally selected). Also available as part of the technology package (WB4/WB7)	●	£166.67	£200.00
7A2	<b>CD changer in the glove compartment.</b> For 6 CDs, MP3 and WMA-compatible, shock-resistant, easily accessible and each CD can be loaded and changed individually. Also supports UDF file system (Windows Vista). Music files with digital rights management (DRM) cannot be played. Not available with DVD/CD changer (6G0)	●	£366.67	£440.00
6G0	<b>DVD/CD changer in glove compartment.</b> For 6 DVDs or CDs, supports audio CDs, video DVDs and MP3, WMA, AAC, MPEG4 and playlists as well as UDF file system (Windows Vista); supports up to 4,000 tracks per medium; shock-resistant and easily accessible in the glove compartment; DVDs and CDs can be changed individually; fast forward and rewind, random playback possible. Music files with digital rights management (DRM) cannot be played. Only available in combination with MMI Navigation Plus (PNQ/WB4/WB7)	●	£566.67	£680.00

Options are subject to availability and may extend delivery.

- = Not available
- = Available
- S = Standard

RRP – Recommended Retail Price.

VAT is calculated at 20% but this may alter to reflect any change in the applicable VAT rate.

# Audio and communication

Order Code	A6 allroad	Basic RRP	Total RRP inc VAT
<b>QU6</b>	●	£725.00	£870.00
<b>9WQ</b>	●	£875.00	£1,050.00

**Digital TV reception.** Reception of digital (DVB-T) uncoded television stations (MPEG-2 standard), TV picture and Electronic Programme Guide (EPG). Facility to connect 2 external AV sources via adaptor cables (available from Audi Accessories). Please note: TV reception depends on local digital network availability. No AV or TV video output when driving (audio output available when driving). Only available in combination with MMI Navigation Plus (PNQ/WB4/WB7)

**Audi Entertainment Mobile.** Includes two 9-inch screens\* supplied by Audi Genuine Accessories which can be easily fitted and includes the ability to connect modern storage devices using a Bluetooth interface, CD/DVD-drive, SD-card slot, USB-interface and AV-IN/OUT. Includes a carry case for player and accessories, remote control, table-top stand, battery for 2.5 hours of external player time, charging lead, headphones, operating instructions and a bonus DVD. The back of each front seat are fitted with mountings and wiring, and the system can also be used outside the car with the rechargeable battery

Options are subject to availability and may extend delivery.

\*Screens must be ordered by your local Audi Centre via Audi Genuine Accessories.

- = Not available
- = Available
- S = Standard

RRP – Recommended Retail Price.

VAT is calculated at 20% but this may alter to reflect any change in the applicable VAT rate.





# Audio and communication

Order Code	A6 allroad	Basic RRP	Total RRP inc VAT
<b>BOSE® surround sound</b> - 14 speakers including centre speaker in the dashboard and subwoofer in the spare wheel well - 12-channel amplifier with a total output of over 600 watts - Acoustics specially tuned to the interior - Surround sound reproduction 5.1 (in combination with MMI Navigation Plus) and stereo recordings (CD, radio, MP3) - AudioPilot for noise-compensating volume adjustment - Powerful, precise bass reproduction	●	£833.33	£1,000.00
<b>Bang &amp; Olufsen Advanced Sound System</b> - 15 speakers including subwoofer and centre speaker, each with its own amplifier channel for genuine 5.1 surround sound - 10-channel DSP full-digital amplifier with a total output of over 1,200 watts, fully digitised and highly efficient 5-channel ICEPower amplifier for woofers and subwoofer - When switched on, two acoustic lenses extend from the dashboard for excellent sound rendition and perspective from all seats - Polished aluminium speaker covers - Acoustics specially tuned to the interior through the targeted use of tweeters, mid-range speakers and woofers - Speakers in encapsulated housings isolate music and telephone conversations within the vehicle for privacy, e.g. when making phone calls in handsfree mode - Automatic adjustment of volume to the driving situation Only available in combination with MMI Navigation Plus (PNQ/WB4/WB7). Please note that this option will reduce the boot space	●	£5,250.00	£6,300.00
<b>Mobile telephone preparation – Low with Bluetooth and voice control.</b> Provides handsfree connection via Bluetooth using a mobile phone aerial. Operation via MMI, the multi-function leather steering wheel or the speech dialogue system. Alternatively, it can use a cradle with charging facility for optimal reception via the external aerial, located in the front centre armrest. Cradle available at extra cost – please contact your Audi Centre for phone compatibility	●	£145.83	£175.00
<b>Mobile telephone preparation – High with Audi connect.</b> Audi connect provides access to a number of innovative online services via an internal UMTS (3G) module. Audi connect online services include: navigation using Google Earth images and Google Street View, destination entry via Google Maps or myAudi, online point of interest search and information services such as weather forecasts and the latest world news. Audi connect also includes Audi traffic information online, which gives accurate real-time forecasts of the traffic situation along the chosen route. The traffic situation can be displayed on the navigation map or Google Earth image. Audi connect can also create a Wi-Fi hotspot in the car for convenient internet access using a mobile device (e.g. laptop or tablet). Many Audi connect features can be simply operated via MMI, the multi-function steering wheel or the voice control system. Only available in combination with MMI Navigation Plus (PNQ/WB4/WB7)	●	£291.67	£350.00

Options are subject to availability and may extend delivery.

– = Not available  
 ● = Available  
 S = Standard

RRP – Recommended Retail Price.

<sup>1</sup>Online services are only available for mobile phone contracts or SIM cards which include a data option and only within the coverage of the mobile phone network; there may be additional costs for the use of these services (charges and billing correspond to the personal mobile phone contract or SIM card contract). Due to high data volumes, a mobile phone contract including an unlimited or high usage data plan is strongly recommended. The content and scope of the online based services offered may vary.

<sup>2</sup>To check the compatibility of your mobile phone and whether it has SIM Access Profile compatibility, please visit [www.audi.co.uk/owners-area/phone-compatibility.html](http://www.audi.co.uk/owners-area/phone-compatibility.html).

VAT is calculated at 20% but this may alter to reflect any change in the applicable VAT rate.

# Audio and communication

Order Code	A6 allroad	Basic RRP	Total RRP inc VAT
<p><b>PNQ</b></p> <p><b>MMI Navigation Plus including MMI Touch.</b> Hard disk navigation with topographical map display, places of interest and town models in 3D. Destinations can be entered via the speech dialogue system or MMI Touch, including 7-digit postcode recognition. The system offers three alternative routes, with the ability to scroll along the selected route and manoeuvre within the map. Includes 8" display with split-screen mode for route information, dynamic route guidance (TMC), intersection zoom function, motorway exits and lane recommendations in Driver's Information System (DIS). Incorporates MPEG4-compatible DVD player and two SDHC memory card readers (for cards of up to 32GB). Also includes vehicle support based on navigation data including: adaptation of transmission, lights and adaptive cruise control with Stop&amp;Go function (depending on options fitted). This system is still available even when navigation is deactivated. Also available as part of the technology package (WB4/WB7)</p>	●	£979.17	£1,175.00
<p><b>KS1</b></p> <p><b>Head-up display.</b> An optical system of mirrors projects driving-related information directly into the driver's field of vision. To prevent ghost images, a special windscreen with a wedge-shaped film is fitted. This film measures approximately 26 x 9cm in size, and the driver perceives the display to be 2 to 2.5m beyond the windscreen. The display has many benefits:</p> <ul style="list-style-type: none"> <li>- Helps to increase safety, convenience and driving pleasure</li> <li>- Straightforward operation via MMI</li> <li>- Display is height-adjustable, adjusts to ambient brightness</li> <li>- High resolution of up to 480 x 240 pixels</li> <li>- The following are displayed (depending on chosen option):             <ul style="list-style-type: none"> <li>- Road speed</li> <li>- Navigation instructions</li> <li>- Adaptive cruise control status, distance from vehicle ahead and set speed</li> <li>- Warning messages</li> <li>- Infotainment lists</li> <li>- Speed limit display</li> </ul> </li> </ul>	●	£1,033.33	£1,240.00

Options are subject to availability and may extend delivery.

- = Not available  
 ● = Available  
 S = Standard

RRP – Recommended Retail Price.

VAT is calculated at 20% but this may alter to reflect any change in the applicable VAT rate.



Bang & Olufsen Advanced Sound System



MMI Navigation Plus including MMI Touch



Head-up display

# Interior equipment

Specify every detail of your car's interior with this range of exclusive options.

Order Code	A6 allroad	Basic RRP	Total RRP inc VAT
<b>9AQ</b>	●	£516.67	£620.00
<p><b>Deluxe 4-zone automatic air conditioning.</b> Includes front control panel with digital display as well as separate temperature control for the driver and front passenger sides. There are additional controls with digital display in the rear with separately adjustable temperature and blower settings for right and left side (rear functions can be set from the front controls). There are also added air vents in the B-pillars and automatic recirculation by means of an air quality sensor, use of residual heat, separate regulation of footwell temperature and ventilated glove compartment with a choice of 3 climates: gentle, medium and intensive</p>			
<b>QQ1</b>	●	£183.33	£220.00
<p><b>Lighting package. Includes lighting for exterior:</b>            - Courtesy lighting on the underside of the door handles and LED door handle lighting for easy entry and exit in the dark            - Automatic activation when the doors are unlocked            - Active internal door reflectors  <b>Interior:</b>            - Entrance lighting            - LED technology            - 2 reading lights at front and rear            - Front footwell            - Inside door handles            - Make-up lights            - Storage compartment in the centre console            - Ambient lighting of the centre console            - Ambient reflected light for inside door trims</p>			
<b>QQ2</b>	●	£433.33	£520.00
<p><b>Ambient lighting.</b> In addition to interior and exterior lighting package (QQ1), anti-glare LED illumination for the passenger compartment. Lighting for door pockets, footwells and inside door handles, reflected lighting for centre console and door inner panels to help occupants find their way around. Surround lighting for centre console (floating effect), make-up lights at front and active door reflectors, with illuminated door sill trims. Configured via MMI</p>			
<b>7HB</b>	●	£429.17	£515.00
<p><b>Extended leather package.</b> Lower part of the centre console, armrests in the doors and door pull handles in leather. Only available in combination with Milano leather (NSW) or Alcantara (N7U)</p>			
<b>7HE</b>	●	£279.19	£335.00
<p><b>Leather covered door armrests.</b> Only available in combination with Valcona leather (NSD)</p>			
<b>2C7</b>	●	£350.00	£420.00
<p><b>Electrically adjustable steering column.</b> Adjustable for height and reach with auto easy entry and exit function. Only available in combination with electric front seats (PV3/PS8)</p>			
<b>3Y3 6RB</b>	●	£208.33	£250.00
<p><b>Manual sun blind for rear window and rear door windows</b></p>			
<b>6NQ</b>	●	£225.00	£270.00
<p><b>Cloth headlining in black</b></p>			
<b>3X2</b>	●	£175.00	£210.00
<p><b>Through-load facility with removable ski/snowboard bag.</b> For practical and safe transportation of long objects, e.g. up to 4 pairs of skis or 2 snowboards. Unrestricted use of the rear seats</p>			

Options are subject to availability and may extend delivery.

- = Not available  
 ● = Available  
 S = Standard

RRP – Recommended Retail Price.

VAT is calculated at 20% but this may alter to reflect any change in the applicable VAT rate.



# Interior equipment

Order Code		A6 allroad	Basic RRP	Total RRP inc VAT
3GN	<b>Load-area fixing kit.</b> Includes fixing set for the rail system in the luggage compartment, with telescopic pole and fastening strap for dividing up the luggage compartment	●	£133.33	£160.00
6SJ	<b>Reversible luggage compartment mat (fabric/rubber).</b> For luggage compartment, velour on one side, rubber on the other. Folds out to cover the luggage compartment	●	£91.67	£110.00
9JC	<b>Smoking package (cigarette lighter and ashtray).</b> Replaces 12V socket in front	●	No charge	No charge
OTX	<b>Vimentum floor mats.</b> In high-quality Jacquard fabric for the front and rear, matched to the selected interior colour. For more information regarding interior trim and floor mat combinations please refer to page 38, and an image of the mats can be seen on pages 10 and 11	●	No charge	No charge

Options are subject to availability and may extend delivery.

- = Not available
- = Available
- S = Standard

RRP – Recommended Retail Price.

VAT is calculated at 20% but this may alter to reflect any change in the applicable VAT rate.



Load-area fixing kit



Split-folding rear seats with optional through-load facility



Deluxe 4-zone automatic air conditioning

# Exterior equipment

Make sure your car looks exactly as you want it to by selecting some of our striking options.

Order Code		A6 allroad	Basic RRP	Total RRP inc VAT
6XG	<b>Exterior mirrors</b> – heated, electrically adjustable, automatic kerb view function which tilts the passenger mirror downwards towards the kerb when reverse gear is engaged and with memory function. Only available in combination with electric front seats (PV3/PS8)	●	No charge	No charge
6XE	<b>Exterior mirrors</b> – heated, electrically adjustable, automatic kerb view function which tilts the passenger mirror downwards towards the kerb when reverse gear is engaged and electrically folding In combination with technology package advanced (WB7)	●	£195.83	£235.00
6XF	<b>Exterior mirrors</b> – heated, electrically adjustable, electrically folding, automatic kerb view function which tilts the passenger mirror downwards towards the kerb when reverse gear is engaged and with memory function. Only available in combination with electric front seats (PV3/PS8) In combination with technology package advanced (WB7)	●	£195.83	£235.00
6XJ	<b>Exterior mirrors</b> – heated, electrically adjustable, automatic kerb view function which tilts the passenger mirror downwards towards the kerb when reverse gear is engaged and auto-dimming	●	£229.17	£275.00
6XM	<b>Exterior mirrors</b> – heated, electrically adjustable, automatic kerb view function which tilts the passenger mirror downwards towards the kerb when reverse gear is engaged, auto-dimming and with memory function. Only available in combination with electric front seats (PV3/PS8)	●	£229.17	£275.00
6XK	<b>Exterior mirrors</b> – heated, electrically adjustable, electrically folding, automatic kerb view function which tilts the passenger mirror downwards towards the kerb when reverse gear is engaged and auto-dimming In combination with technology package advanced (WB7)	●	£429.17	£515.00
6XL	<b>Exterior mirrors</b> – heated, electrically adjustable, electrically folding, auto-dimming, automatic kerb view function which tilts the passenger mirror downwards towards the kerb when reverse gear is engaged, auto-dimming and with memory function. Only available in combination with electric front seats (PV3/PS8) In combination with technology package advanced (WB7)	●	£233.33	£280.00
4KF	<b>Privacy glass.</b> Dark tinted rear and rear-side windows (from B-pillar backwards)	●	£325.00	£390.00
1D4	<b>Tow bar.</b> Ball head and ball joint coupling made from forged steel. Mechanically swivelling ball head, operated via Bowden cable, with indicator light on Bowden cable and display in instrument cluster to monitor secure attachment of trailer towing hitch, includes trailer stabilisation system via the Electronic Stability Control (ESC). Includes single European 13-pin electrics socket and may require a 13-to-7-pin adaptor. Please consult your Audi Centre for details*	●	£687.50	£825.00

Options are subject to availability and may extend delivery.

– = Not available  
● = Available  
S = Standard

RRP – Recommended Retail Price.

\*Additional wiring is required for auxiliary equipment.

VAT is calculated at 20% but this may alter to reflect any change in the applicable VAT rate.

# Exterior equipment

Order Code		A6 allroad	Basic RRP	Total RRP inc VAT
3FU	<b>Panoramic glass sunroof.</b> Comprises two sections, whereby the front glass section can be tilted or slid open and closed again electrically. Includes electrically operated sun blind for the front and rear passengers. Can also be closed from the outside via the central locking	●	£1,020.83	£1,225.00
GZ2	<b>Power door closure.</b> Automatically pulls doors that are not completely engaged into the lock	●	£516.67	£620.00
ZZ0	<b>Removal of model and technology designation</b>	●	No charge	No charge
VJ1	<b>Full paint finish.</b> Includes front and rear bumpers, wheel arches and side sills painted in body colour with a matt finish. Not in combination with Brilliant black A2 or Ibis white T9	●	£445.83	£535.00

Options are subject to availability and may extend delivery.

- = Not available
- = Available
- S = Standard

RRP – Recommended Retail Price.

VAT is calculated at 20% but this may alter to reflect any change in the applicable VAT rate.



Panoramic glass sunroof



Exhaust pipes

# Safety and security

Intelligent technology designed to give you better all-round awareness and safety on the road.

Options are subject to availability and may extend delivery.

- = Not available
- = Available
- S = Standard

RRP – Recommended Retail Price.

VAT is calculated at 20% but this may alter to reflect any change in the applicable VAT rate.

Order Code		A6 allroad	Basic RRP	Total RRP inc VAT
8X1	<b>Headlight washer system</b>	S	No charge	No charge
PXB	<b>Bi-Xenon headlights with adaptive light and high-beam assist.</b> With LED daytime-running lights, LED tail lights and headlight washers. Includes swivelling headlights for improved illumination of a winding road, and dynamic cornering light function which pivots the headlights based on the movement of the steering wheel (operational between speeds of approximately 6mph and 68mph). Turning light function is activated when indicator is switched on (up to speeds of 45mph). The headlights have three different light distribution modes: town light, motorway light or country light, which are adjusted according to speed or via navigation route data (if fitted with MMI navigation plus with MMI touch – PNQ). Additional functionality via navigation-based vehicle support includes junction light, which provides a wide front light setting, as well as travel mode, which switches between right and left-hand drive modes assisted by GPS data. High-beam assist automatically adjusts headlights from high-beam to dipped-beam when another vehicle is approaching or when other ambient lighting is detected (i.e. street lights) by a camera on the interior mirror. Not available in combination with all-LED headlights (PX2)	•	£1,045.83	£1,255.00
PX2	<b>All-LED headlights including high-beam assist.</b> LEDs for all front lighting functions. LED technology provides lower energy consumption and enhanced contrast with a colour similar to daylight, for increased safety and good recognition by other road users. Includes all-weather light function to reduce the risk of the driver being dazzled when visibility is poor (in fog, rain or snow), turning light function which is activated when indicator is switched on (up to speeds of 45mph), and an additional motorway light which automatically increases headlight range at speeds above approximately 68mph. Also includes high-beam assist which automatically adjusts headlights from high-beam to dipped-beam when another vehicle is approaching or when other ambient lighting is detected (i.e. street lights) by a camera on the interior mirror. Not available in combination with Bi-Xenon headlights with adaptive light and high-beam assist (PXB)	•	£1,812.50	£2,175.00
7W1	<b>Pre-sense basic.</b> Audi pre-sense is a comprehensive technical package for identifying dangers well in advance and intervening appropriately. Pre-sense basic networks the different vehicle systems, enabling driving situations to be categorised and, where necessary, actions to be taken to protect the driver and passengers. These include: belt tightening, activating the hazard warning system, closing the windows and the sunroof (if fitted)	•	£216.67	£260.00



All-LED headlights including high-beam assist

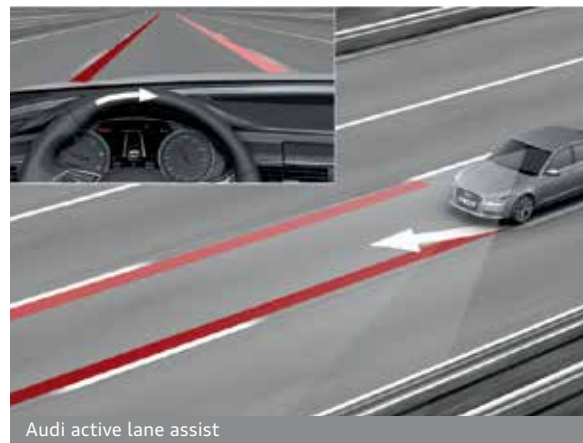

Audi active lane assist

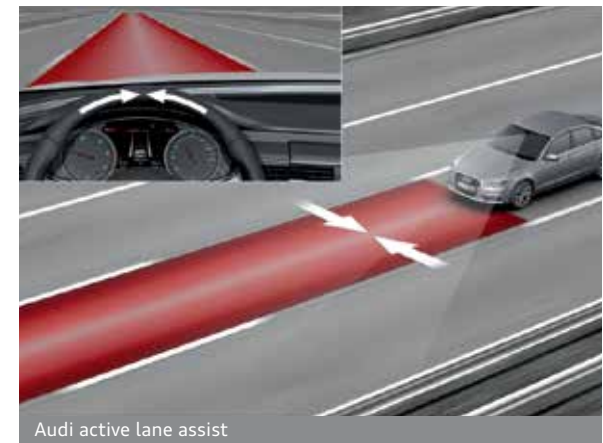

Audi active lane assist



# Safety and security

Order Code	A6 allroad	Basic RRP	Total RRP inc VAT
<p><b>PCB</b></p> <p><b>Audi active lane assist.</b> Helps the driver to stay in lane with gentle steering impulses for greater safety and convenience, particularly on motorways and country roads:</p> <ul style="list-style-type: none"> <li>- Informs driver if car is drifting out of lane unintentionally above approximately 37mph</li> <li>- Driver has the choice of two system settings in the MMI:           <ul style="list-style-type: none"> <li>- Early steering intervention – continuously helps the driver to stay in lane with steering impulses that centre the vehicle in its lane</li> <li>- Late steering intervention – alerts the driver that the vehicle is possibly crossing the lane markings at the same time as providing a corrective steering prompt</li> </ul> </li> <li>- Additional warning in the form of vibrating steering wheel when lane markings are crossed, if specified by driver</li> <li>- Camera identifies individual or coloured lane markings, e.g. yellow lines at roadworks</li> <li>- Additional indication in head-up display (if selected as an option)</li> </ul>	●	£333.33	£400.00
<p><b>PCH</b></p> <p><b>Audi side assist including pre-sense rear.</b> Aids the driver when changing lane. Audi side assist monitors the area behind your car, using radar sensors located discreetly in the rear bumper, informing the driver with a visual warning signal in the door mirror if there is a vehicle in their blind spot or approaching quickly from behind. The system is activated using a button in the driver's door and works at speeds above 19mph. The airbags are also pre-conditioned. Only available in combination with electrically folding door mirrors (6XE/6XF/6XK/6XL)</p>	●	£437.50	£525.00
<p><b>PCD</b></p> <p><b>Audi side assist including pre-sense rear and Audi active lane assist.</b> Includes all the features of Audi side assist including pre-sense rear (PCH) and Audi active lane assist (PCB). Only available in combination with electrically folding door mirrors (6XE/6XF/6XK/6XL)</p>	●	£770.83	£925.00
<p><b>PCG</b></p> <p><b>Adaptive cruise control (ACC) with Stop&amp;Go function including pre-sense front.</b> Automatic distance regulation, using radar sensors to maintain required distance by braking and accelerating. Four programs (distance 1 to distance 4) set via steering column controls of the cruise control system. Works at speeds between 0 and 155mph* and also includes Audi braking guard – a system which triggers a visual and acoustic alarm when it detects the risk of a rear end collision with the vehicle in front. In addition, the airbags are pre-conditioned if a crash is sensed and the system is prepared to assist with the necessary braking force once the brake pedal is touched. Only available in combination with colour Driver's Information System (9Q8) and Bi-Xenon or all-LED lights (PXB/PX2)</p>	●	£1,108.33	£1,330.00
<p><b>PCN</b></p> <p><b>Adaptive cruise control (ACC) with Stop&amp;Go function, Audi side assist and Audi active lane assist with pre-sense plus.</b> Includes all of the features of PCG and PCD plus Audi pre-sense plus which, in a situation where a collision is inevitable, allows full brake application to try to lessen the impact of the collision. Only available in combination with electrically folding door mirrors (6XE/6XF/6XK/6XL), colour Driver's Information System (9Q8) and Bi-Xenon or all-LED lights (PXB/PX2). Also available as part of the technology package advanced (WB7)</p>	●	£1,879.17	£2,255.00

\*Where the law permits.

Options are subject to availability and may extend delivery.

- = Not available
- = Available
- S = Standard

RRP – Recommended Retail Price.

VAT is calculated at 20% but this may alter to reflect any change in the applicable VAT rate.

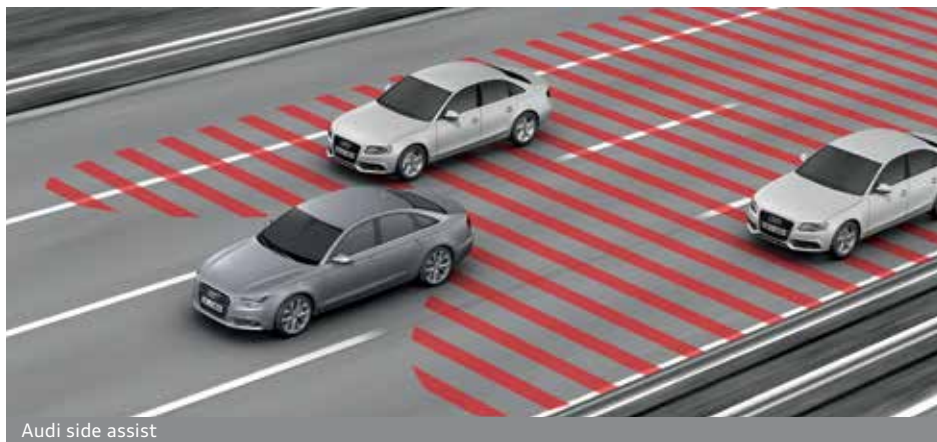

Audi side assist



Adaptive cruise control

# Safety and security

Order Code		A6 allroad	Basic RRP	Total RRP inc VAT
7X5	<b>Park assist.</b> Searches for suitable parking spaces along the road by means of ultrasonic sensors, calculates the ideal parking path and performs the steering action virtually automatically. Steering is done by the vehicle, the driver need only accelerate and apply the brakes. Only available in combination with colour Driver's Information System (9Q8)	●	£341.67	£410.00
KA2	<b>Audi parking system advanced with reversing camera.</b> An image of the area behind the vehicle is shown on the MMI display, with dynamic display modes showing the calculated path (steer-angle dependent); includes help lines, guidelines and identification of the point at which to apply opposite lock when parallel parking. The reversing camera is concealed in the handle strip of the tailgate	●	£333.33	£400.00
QR9	<b>Speed limit display.</b> The prevailing speed limit can be simply read on the Driver's Information System (DIS). Should the camera fail to see a sign properly, the speed limit from the data for the navigation system – if fitted – will be shown instead. The advantages: - Display of the speed limits currently registered, which can be called up in the Driver's Information System at any time - Display can be called up in every instrument cluster view and in the head-up display (optional equipment) - Camera-based system is also capable of detecting temporary speed restrictions in roadworks and on digital displays (e.g. over motorways) within the system limits - Display of national speed limits for Western European countries Only available in combination with MMI Navigation Plus (PNQ/WB4/WB7), and with Audi active lane assist (PCB), Audi side assist (PCD) or Adaptive cruise control (PCG/PCN)	●	£208.33	£250.00
9R1	<b>Night vision assistant with pedestrian detection.</b> A thermal imaging camera (remote infrared with resolution of 320 x 240 pixels) registers heat dissipation in front of the vehicle and represents this image in the Driver's Information System (DIS). Image recognition software highlights people detected in the darkness in yellow, and if the system classifies them as being at risk, a warning bell is sounded and the image changes to red. If combined with Bi-Xenon headlights with adaptive light and high-beam assist (PXB) the person detected is also illuminated by the headlights three times in succession to alert them to the danger. System operation may be restricted in too much ambient light, high humidity and high night temperatures (over 28°C). Only available in combination with colour Driver's Information System (9Q8) and Bi-Xenon or all-LED lights (PXB/PX2)	●	£1,258.33	£1,510.00

Options are subject to availability and may extend delivery.

- = Not available  
● = Available  
S = Standard

RRP – Recommended Retail Price.

VAT is calculated at 20% but this may alter to reflect any change in the applicable VAT rate.

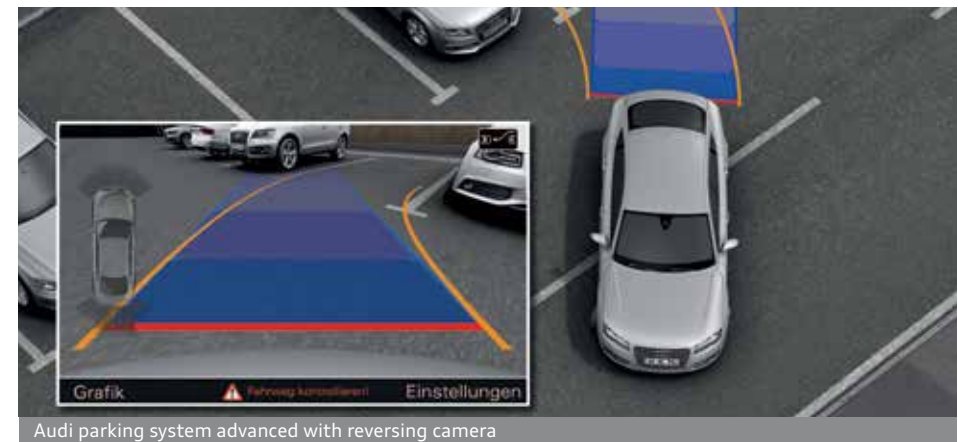

# Safety and security

Order Code		A6 allroad	Basic RRP	Total RRP inc VAT
KA6	<b>Audi parking system advanced with top view.</b> Aids parking and manoeuvring using four cameras. Cameras are mounted in the front grille, the handle of the boot lid and the housing of the two exterior mirrors. The driver can choose between different image representations in the MMI display, including a live "bird's eye view" image for parking. Only available in combination with memory mirrors (6XF/6XG/6XL/6XM), electric seats (PV3/PS8) and MMI Navigation Plus (PNQ/WB4/WB7)	●	£750.00	£900.00
4F2	<b>Advanced key.</b> Access and authorisation system that works through automatic data exchange between key and vehicle, allowing the driver to keep their car key in their pocket or bag at all times. To unlock and open, simply lift the exterior door handle. The door is locked by pressing the button on the handle. Pressing the start/stop button integrated in the centre console starts and stops the engine	●	£479.17	£575.00
VC1	<b>Garage door opener (HomeLink®).</b> * Programmable radio remote control, with buttons integrated into the front roof module; can be used for opening garages and exterior gates	●	£204.17	£245.00
4X4	<b>Rear side airbags.</b> For the outer rear seats, incorporated into the seat backrests; supplements the side impact protection in the doors and the head airbag system	●	£312.50	£375.00
7G9	<b>Tracking preparation.</b> Fitting for the connection of a tracking assistant, which enables the vehicle to be located if stolen. Please contact your local Audi Centre for full details	●	£91.67	£110.00
0M5	<b>75-litre fuel tank</b>	●	£95.83	£115.00

Options are subject to availability and may extend delivery.

\*Homelink® is a registered trademark of Johnson Controls. For information on compatibility, visit [www.homelink.com](http://www.homelink.com).

- = Not available  
● = Available  
S = Standard

RRP – Recommended Retail Price.

VAT is calculated at 20% but this may alter to reflect any change in the applicable VAT rate.



Night vision assistant with pedestrian detection



Audi parking system advanced with top view

# Steering wheels

Order Code		A6 allroad	Basic RRP	Total RRP inc VAT
1XX	3-spoke leather-trimmed multi-function Sports steering wheel. With gear-shift paddles	S	No charge	No charge
1XT	3-spoke leather-trimmed multi-function Sports steering wheel – heated. With gear-shift paddles	•	£154.17	£185.00
2ZS	4-spoke leather-trimmed multi-function steering wheel. With gear-shift paddles	•	No charge	No charge
2ZM	4-spoke leather-trimmed multi-function steering wheel – heated (without gear-shift paddles). Please note this is not available on the 3.0 BitDI 313PS	•	No charge	No charge

Options are subject to availability and may extend delivery.

- = Not available
- = Available
- S = Standard

RRP – Recommended Retail Price.

VAT is calculated at 20% but this may alter to reflect any change in the applicable VAT rate.









## Looking after your Audi

When you've chosen your ideal model, it's reassuring to know that it will remain in safe hands. That's why we've created products to protect your Audi, from extended warranties to Audi Complete – our comprehensive service and maintenance package. And there's also a range of Audi accessories and merchandise to choose from, enabling you to further enhance and safeguard your car.





# Audi Complete

Audi Complete is simply a way to look after the servicing and maintenance costs for your Audi in a single package. You pay a one-off or monthly fee and we'll cover all your servicing, maintenance and tyres for the next three years including your first MOT. It means you only have to pay for fuel, insurance and your Road Fund Licence. So you can be reassured that your car will be maintained by trained Audi Technicians, using genuine Audi parts. You can also opt for our Service only or Service and Maintenance packages if you prefer.

\*Retail customers only. Pricing based on 3 years/30,000 miles (whichever occurs sooner). All pricing is a 'starting from' price for the Audi A6 allroad range and is therefore subject to change and mileage/model dependent.

## Warranty

Options are subject to availability and may extend delivery.

- = Not available  
• = Available  
S = Standard

\*\*Only available prior to registration of your A6 allroad. Please speak to your Audi Centre for full details.

RRP – Recommended Retail Price.

VAT is calculated at 20% but this may alter to reflect any change in the applicable VAT rate.

Order Code			A6 allroad	Basic RRP	Total RRP inc VAT
-	<b>Audi Complete – Service only.</b> Comprehensive care for your Audi covering all your servicing for 3 years. Visit your local Audi Centre for further information or <a href="http://audi.co.uk/audicomplete">audi.co.uk/audicomplete</a> for full details including terms and conditions	Monthly Direct Debit	●	£15.00	£18.00*
-	<b>Audi Complete – Service and Maintenance.</b> Comprehensive care for your Audi covering all your servicing and maintenance for 3 years, as well as your first MOT. Visit your local Audi Centre for further information or <a href="http://audi.co.uk/audicomplete">audi.co.uk/audicomplete</a> for full details including terms and conditions	Monthly Direct Debit	●	£20.83	£25.00*
-	<b>Audi Complete – Service, Maintenance and Tyres.</b> Comprehensive care for your Audi covering all your servicing, maintenance and tyres for 3 years, as well as your first MOT. Visit your local Audi Centre for further information or <a href="http://audi.co.uk/audicomplete">audi.co.uk/audicomplete</a> for full details including terms and conditions	Monthly Direct Debit	●	£36.67	£44.00*

Order Code			A6 allroad	Basic RRP	Total RRP inc VAT
-	<b>Audi Warranty.</b> Covering you for unlimited mileage in the first 2 years of ownership, and up to 60,000 miles in the third year. Transferable between owners**		●	No charge	No charge
EA6	<b>Audi Warranty.</b> Covering you for up to 4 years or 75,000 miles, whichever comes sooner. Cover includes a 2-year unlimited mileage warranty, and up to 75,000 miles in the third and fourth years. Transferable between owners**		●	£466.67	£560.00
EA9	<b>Audi Warranty.</b> Covering you for up to 5 years or 90,000 miles, whichever comes sooner. Cover includes a 2-year unlimited mileage warranty, and up to 90,000 miles in the third, fourth and fifth years. Transferable between owners**		●	£1,112.50	£1,335.00



## Accessories

Choosing an Audi isn't just a matter of deciding on the model you want; it's about creating a car that suits your needs perfectly. And that's why we've developed a whole range of accessories to enhance your A6 allroad, enabling you to customise it down to the last detail. Like your Audi, all these accessories are developed to the highest possible standards. They're all available exclusively from Audi. To find out more, just visit your local Audi Centre.

### Warranty

All of the accessories available on the A6 allroad are covered by a three-year warranty\* if they are ordered and included in the purchase price of the car at date of delivery. Any accessories ordered and installed after delivery include a two-year warranty.\*

\*Excluding Road Angel products.

Audi Accessories warranty terms and conditions can be found at [audi.co.uk](http://audi.co.uk)



## Merchandise

From the enthusiasts' motorsport collection to the sophisticated Audi collection, there's a wide variety of adults' and children's clothing, lifestyle accessories and collectables, all of which bear the Audi name.

Please speak to a member of our team at your local Audi Centre to see the full Audi collection and to place an order. A selection of Audi merchandise is also available to buy from [audi.co.uk/merchandise](http://audi.co.uk/merchandise).



# Audi Difference

## The experts in Vorsprung durch Technik

Our Audi Approved Master Technicians have undergone an impressive 100,000 hours of training over a 10-year programme to ensure they have the latest technical expertise for maintaining and servicing your Audi. All our Service Advisors undergo a specialist induction and training to ensure they are Audi professionals and able to talk to you about any issues you may have with your Audi vehicle.

## Servicing tailored to your needs

Regular servicing is key to safeguarding your Audi's performance and a full Audi service history could help you enhance the future re-sale value. To make servicing easy, the Audi Service Schedules have been designed to work with your individual driving style and vehicle.

We offer two different schedules: the fixed Inspection Service and the variable LongLife Service schedule. The conventional fixed Inspection Service schedule has fixed intervals for the Oil-change Service and Inspection Service, which are determined by time and distance.

With the variable LongLife Service schedule, the Inspection Service intervals are also fixed but the Oil-change Service intervals are variable. Sensors take account of driving style and conditions to determine when the Oil-change Service is required and the driver is informed via the on-board service interval display.

The choice of Service Schedule will depend on journey type and mileage as well as individual driving style and conditions. The table to the right can be used for guidance but your Audi Centre will help you to determine the most suitable Service schedule for you based on your individual circumstances and preferences.

### Fixed Inspection Service Schedule

	Vehicle usage:
Mileage	Less than 10,000 miles per annum Mainly city/town centre driving. Short journeys.
	Service Intervals:
Oil-change Service	Fixed to every 9,000+ miles/1 year
Inspection Service	Fixed to every 19,000+ miles/2 years

### Variable LongLife Service Schedule

	Vehicle usage:
Mileage	More than 10,000 miles per annum Motorway and main road driving. Mainly longer distance journeys. Constant speeds.
	Service Intervals:
Oil-change Service	Variable to a maximum of every 19,000+ miles/2 years
Inspection Service	Fixed to every 19,000+ miles/2 years

When a vehicle is frequently used in the following conditions, we recommend a Fixed Inspection Service Schedule, regardless of mileage:

Uneconomical driving styles, e.g. heavy acceleration and braking, constant use of high revs

High engine-loading conditions, e.g. frequent towing and hill climbs

\*As indicated by the service interval display. Mileages are approximate as the Service Indicator system uses kilometres as its distance measurement.

## Your convenience comes first

At Audi you can choose from a range of convenient services that suit your needs. Why not book a 'service while you wait' appointment\* and enjoy our complimentary refreshments while your car is with us? Or, if you need to be mobile, take advantage of one of our courtesy cars which we can even deliver to you.\* We guarantee we can service your Audi within 5 days without a courtesy car or within 10 days if you need transport. We will also ensure your car is returned to you with a full valet.

## Audi Genuine Parts

You can rest assured that only Audi Genuine Parts will be used on your vehicle. What's more, Audi parts and labour come with a 2-year guarantee.\*\*

## No hidden costs

We believe strongly in transparency when it comes to our prices. For added peace of mind, we will give you a quotation over the phone for the work you have requested and email you the price confirmation. We'll consult you if any additional work on your car is needed when it is with us. We won't carry out any extra work without asking your permission first.

## All part of the service

Whenever we see an Audi for a service, we connect it directly to our headquarters in Ingolstadt which enables us to check your car's software and make sure it's as up-to-date as possible. If the factory has released a software upgrade for your model, it can be applied immediately - improving anything from your car's efficiency to the precision of its parking system.

## Audi Roadside Assistance

Your new car comes complete with 3 years' complimentary roadside assistance and recovery across the UK, provided by RAC Motoring Services. Also included is roadside assistance throughout Europe, managed by RAC Motoring Services.

For further information and terms and conditions please visit [audi.co.uk](http://audi.co.uk).

\* Subject to availability.

\*\*Excludes wear and tear.



# A6 allroad technical data

	Diesel		
Engine	3.0 TDI quattro	3.0 TDI quattro	3.0 BiTDI quattro
Transmission	7-speed S tronic	7-speed S tronic	8-speed tiptronic
Cylinder	6-cylinder	6-cylinder	6-cylinder
Displacement, cubic cm (valves per cylinder)	2967 (4)	2967 (4)	2967 (4)
Max. power, <sup>2</sup> PS at rpm	204/3200-4500	245/4000-4500	313/3900-4500
Max. torque, Nm at rpm	450/1250-3000	580/1750-2500	650/1450-2800
Top speed, mph	139	147	155*
0-62mph acceleration, seconds	7.5	6.6	5.6
CO <sub>2</sub> emissions, <sup>2</sup> g/km	159	165	176
Benefit in kind (BIK)%	26%	28%	30%
Fuel consumption, <sup>2</sup> mpg (l/100km) Urban	40.4 (7.0)	38.2 (7.4)	35.8 (7.9)
Fuel consumption, <sup>2</sup> mpg (l/100km) Extra Urban	51.4 (5.5)	50.4 (5.6)	47.1 (6.0)
Fuel consumption, <sup>2</sup> mpg (l/100km) Combined	46.3 (6.1)	44.8 (6.3)	42.2 (6.7)
ABI insurance group 1-50 <sup>+</sup>	31 E	36 E	41 E
Unladen weight, <sup>3</sup> kg	1855	1855	1910
Gross weight limit, kg	2505	2505	2560
Roof load limit/nose weight, kg	100/100	100/100	100/100
Max trailer load unbraked, <sup>4</sup> kg	750	750	750
Max trailer load with 12% gradient, <sup>4</sup> kg	2500	2500	2500
Max trailer load with 8% gradient, <sup>4</sup> kg	2500	2500	2500
Luggage compartment capacity, rear seats upright, litres	565	565	565
Fuel tank capacity approx, litres	65	65	65
Emission standard	EU5	EU5	EU5

\*Electronically limited

<sup>+</sup>Highest insurance group rating shown. Group may be lower dependent on trim level. Please visit [www.thatcham.org/abigrouprating](http://www.thatcham.org/abigrouprating) for details.

<sup>2</sup>The given value was obtained in accordance with the specified measurement procedure (the respective current version of the Directive 80/1269/EEC).

<sup>2</sup>Fuel consumption and CO<sub>2</sub> emissions figures are obtained under standardised test conditions (Directive 93/116/EEC) using a representative model. This allows direct comparison between different models from different manufacturers, but may not represent the actual fuel consumption achieved in 'real world' driving conditions. More information is available at [www.vca.gov.uk](http://www.vca.gov.uk).

<sup>3</sup>Vehicle's unladen weight without driver (calculated in accordance with the current version of Directive 80/1268/EEC). The fitting of additional equipment may increase the vehicle's unladen weight and drag coefficient, whereupon the potential carrying capacity and top speed will be correspondingly reduced.

<sup>4</sup>The engine's power output always goes down with increasing altitude. At 1,000m above sea level, and for every additional 1,000m, deduct 10% from the weight of the outfit (trailer load limit + gross weight of the towing vehicle).

**Please note:** The maximum power output figures are quoted in PS (or Pferdestärke, which is the metric equivalent of brake horsepower). To convert to brake horsepower, divide the PS figure by 1.0139.



# A6 allroad dimensions

The technical drawings opposite show the exact dimensions of the A6 allroad, so you can check everything – from whether the car will fit in your garage to whether your luggage will fit in the boot.

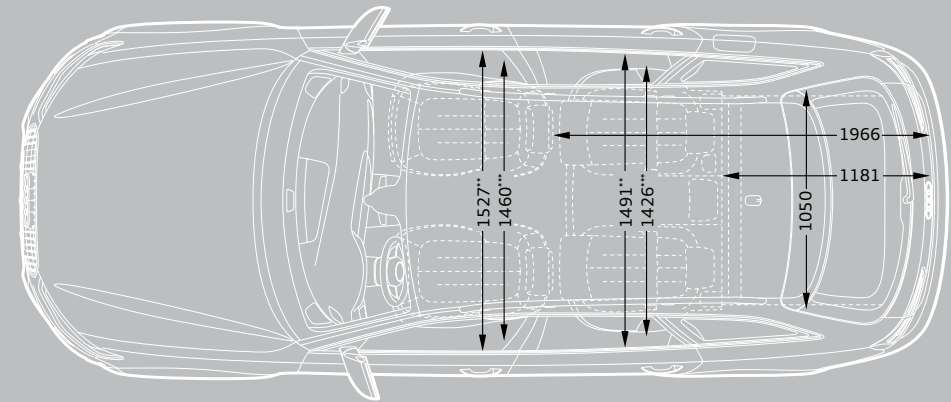
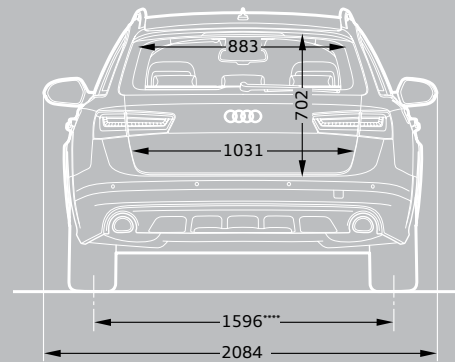
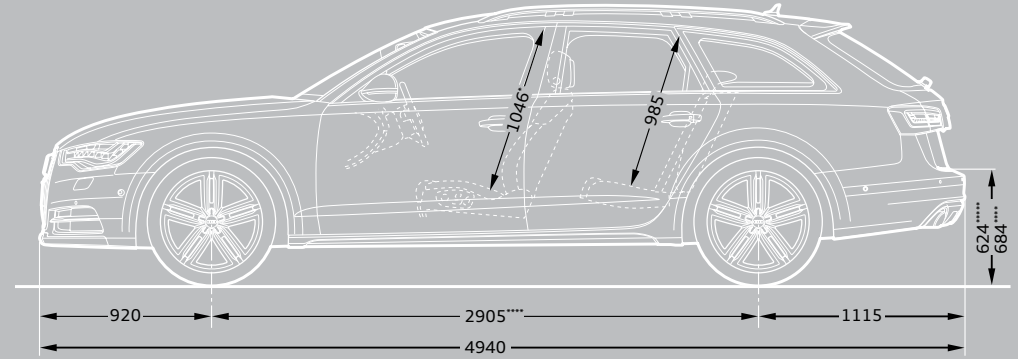
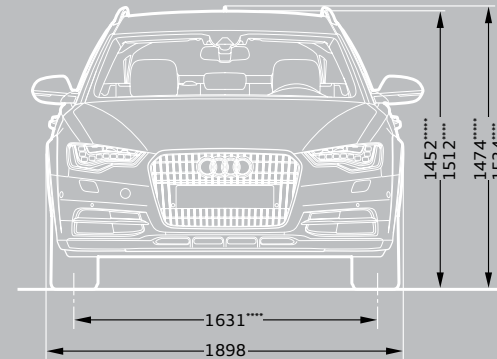

Dimensions measured with vehicle at unladen weight.

Turning circle approx 11.9m.

Dimensions in millimetres.

- \* Maximum headroom
- \*\* Elbow room width
- \*\*\* Shoulder room width
- \*\*\*\* Lift mode
- \*\*\*\*\* Dynamic mode

# Pricing and Additional information

## Welcome to Audi

By placing an order for your Audi, you're choosing to get behind the wheel of one of the most sophisticated cars on the road. And because we believe the service we offer should be just as advanced, we want to let you know exactly what you can expect from us, now and in the future.

We've agreed a set of standards with all our Centres which governs the way we do business with you. It outlines the kind of service we promise to deliver for every customer, right down to filling each new Audi we sell with half a tank of fuel.

So whether you're interested in the date your car will arrive in the UK or the way we'll dispose of non-biodegradable materials after we service your Audi, you can have total confidence in us.

## Audi Promise

### Audi Centres

We guarantee that all our Centres will be open as follows:

Sales: Monday to Friday 9am–6pm  
Saturday 9am–5pm

Service: Monday to Friday 8am–6pm  
Saturday 8.30am–1pm

Sunday opening is at local discretion.

### New car delivery

Once we've confirmed a delivery date for your car, we'll keep you informed of progress. Subject to reasonable notice, we'll then deliver it to a place of your choice, whether that's your home or work. In the unlikely event of a delay, we'll provide a courtesy car to minimise inconvenience and keep you mobile.

### Environmental commitment

We promise to dispose of all non-biodegradable materials from your vehicle in a responsible manner.

### Pricing

Prices and specifications given are correct at the time of printing. Always check details with your Audi Centre as Audi policies are continually developing. We reserve the right to change prices or specifications at any time.

All prices are subject to VAT, currently charged at 20%, but this may alter to reflect any change in the applicable VAT rate.

Delivery charges and number plates are not included in the vehicle price.

Delivery charge	£471.66
Number plate	£20.00
VAT	£98.34
Total	£590.00

## Audi Customer Care

Every new Audi benefits from the comprehensive Audi Customer Care Package, which comprises:

- ▶ A 3-year Audi warranty, which covers you for unlimited mileage in the first 2 years of ownership, with a full mechanical and electrical warranty which covers you for up to 60,000 miles in the 3rd year
- ▶ A 3-year paint warranty
- ▶ A 12-year anti-corrosion warranty
- ▶ 3 years' UK roadside assistance and recovery

You also have the option when ordering your new car of choosing a 4-year or 5-year Audi warranty. Speak to a member of the sales team for more information.

### Audi tax-free sales

If you are entitled to purchase a vehicle free of VAT, normally through military or diplomatic privilege, please contact your local Audi Centre for full details.

Should you have any difficulty obtaining the information you require, please call Freephone 0800 585878.

### Audi Finance

Audi Finance specialises in providing funding solutions for Audi drivers. Whether your Audi is for private or business use, there is a range of funding options to choose from.

Below is the full range of finance products, which comprises:

- ▶ Solutions – a Personal Contract Plan
- ▶ Hire purchase
- ▶ Lease purchase
- ▶ Finance lease
- ▶ Contract hire

With all products, you can choose a fixed-cost maintenance plan designed to help you budget accurately.

No matter which Audi model you choose, your local Audi Centre can provide you with a personalised quote designed to fit your budget and motoring needs.

Audi Finance is a trading name of Volkswagen Financial Services (UK) Limited. An offer of finance depends on certain conditions. Available to people over 18 in the UK only.

### Audi Insurance

We want you to start enjoying your new car from day one and thanks to Audi Insurance complimentary 7-day cover, you can. Call free on 0800 316 7893 (lines are open Monday to Friday 8am–9pm, and Saturday 9am–5pm), provide a few details and a cover note will be sent to your Audi Centre. They will then tax your car and you can drive it away.

# Additional information

## CO<sub>2</sub> data and information

### CO<sub>2</sub> emissions-based Vehicle Excise Duty

Vehicle Excise Duty (Road Fund Licence) is based upon the amount of Carbon Dioxide (CO<sub>2</sub>) a vehicle emits, measured in grams per kilometre (g/km). First year VED rates apply to the first year of ownership. Annual VED rates apply thereafter. The DVLA has created thirteen categories:

Petrol and Diesel engines	First year	Annual rate (second year onwards)
A – up to 100g/km	£0.00	£0.00
B – 101 to 110g/km	£0.00	£20.00
C – 111 to 120g/km	£0.00	£30.00
D – 121 to 130g/km	£0.00	£105.00
E – 131 to 140g/km	£125.00	£125.00
F – 141 to 150g/km	£140.00	£140.00
G – 151 to 165g/km	£175.00	£175.00
H – 166 to 175g/km	£285.00	£200.00
I – 176 to 185g/km	£335.00	£220.00
J – 186 to 200g/km	£475.00	£260.00
K – 201 to 225g/km	£620.00	£280.00
L – 226 to 255g/km	£840.00	£475.00
M – over 255g/km	£1,065.00	£490.00

Vehicle Excise Duty (VED) rates correct at time of going to print, but these may alter to reflect any change in the applicable VED rate











**Audi UK**

Customer Services  
Selectapost 29  
Sheffield  
S97 3FG  
0800 699888  
audi.co.uk

Specifications and prices subject  
to change without notice.

© Audi (UK)

Printed in the UK  
Edition 2.0 05/13  
2014 model year

Images are for illustrative purposes only.

