



The Audi Q3

Pricing and Specification Guide
Valid from June 2013

Personalising your Audi Q3

This guide has been designed to help you tailor and price your Audi Q3 quickly and logically. At the back, you will find information on CO2 emissions-based taxation and the other services offered by Audi, including Finance and Insurance. You can also configure your Audi Q3 online at audi.co.uk.

Audi Vision

To accompany this printed guide, we've created Audi Vision – an intuitive app that lets you find out even more about the Audi Q3. Compatible with Apple and Android phones and tablets, Audi Vision gives you exclusive access to images, information and video content – all of which is designed to help you explore and understand the options available with this model.

You'll see the Audi Vision logo printed next to the page number on pages throughout this guide and wherever you do, you'll be able to view additional content on that page.



The Audi Q3

Engines	12
Transmission	13
Efficiency	14
quattro®	16

Model details and prices

SE model equipment	20
S line model equipment	24
Model prices	26

Audi exclusive

Colour and upholstery

Paint	30
Upholstery	34
Colour and trim guide	42
Seats	43

Inlays

Options

Wheels, tyres and suspension	50
Packages	54
Audio and communication	56
Interior equipment	58
Exterior equipment	60
Safety and security	62
Steering wheels	64

Looking after your Audi

Audi Complete and warranty	66
Accessories	69
Merchandise	70
Audi Difference	71

Technical details

Technical data	72
Dimensions	73
Pricing and Additional information	74





Vorsprung durch Technik

Three words that express the very essence of Audi. Vorsprung durch Technik isn't a slogan. It's our way of seeing the world. It is the driving force behind our history of innovation that continues into the 21st century. Indeed, many technologies that Audi pioneered remain in our cars today. Some are milestones in the history of the motorcar.

From our beginnings in 1899, to the Auto Union team's Grand Prix successes in the 1930s and our more recent wins at Le Mans, we have always been at the forefront of the motor industry.

Vorsprung durch Technik makes us who we are. To see more of its influence, just read on.





The Audi Q3. Compact quattro.

With its flowing roofline and aerodynamic shape, the Audi Q3 has coupé-like looks you might not expect in an SUV. But its practical qualities are also there for all to see, thanks to a spacious 5-seat interior, 420 litres of boot space, high ground-clearance and the availability of quattro® permanent all-wheel-drive. A high level of specification comes as standard, including 17-inch alloy wheels and rear parking sensors, as well as Audi Music Interface, Bluetooth interface and Concert radio, all easily controlled from a 6.5" display screen with MMI operating logic.

We've also incorporated efficient technology to save energy and reduce waste. Start-Stop technology switches off the engine when you're waiting in traffic and Recuperation recharges the battery using energy that would otherwise be wasted. In addition, TDI® and TFSI® precisely control fuel injection, making the most of every drop.









Q3 interior story

We've introduced a number of finishing touches to the Audi Q3's interior to make your driving experience both comfortable and unique. You'll find an impressive attention to detail in everything from the 6.5-inch retractable screen to the optional luxurious leather upholstery, which means that every journey you make will be a personal one.

Engines

Petrol

FSI® direct-injection technology is a unique Audi innovation that was originally developed for the Le Mans 24-hour endurance race to deliver more power and torque, as well as enhanced fuel efficiency. Precisely the right amount of fuel and air are injected into the combustion chambers, enabling the engine to 'breathe' more easily. It results in reduced heat loss and increased output, with around a 15% reduction in fuel consumption and significantly lower exhaust emissions. We've also developed TFSI® with turbocharging, which combines FSI® technology with forced induction – giving cars an extra injection of power.

Diesel

We introduced TDI® to the roads in 1989, and since then, we've continuously refined it, including developing common-rail technology. With this system, a series of piezo injectors use electrical charge to precisely control the amount of fuel injected into the engine. As well as reducing noise, this allows combustion to happen at a lower temperature, with less oxygen, which lowers emissions.



Transmission

S tronic®

Driving is all about thinking ahead, which is just what the S tronic® dual-clutch transmission does. It works almost as two separate systems, one engaging the odd-numbered and the other the even-numbered gears. So when you're accelerating in second, it has third gear waiting for you. And once you make the switch, it's already thinking about fourth. With two clutches working together, you can change gears almost instantly while experiencing smooth, uninterrupted power.

The S tronic® transmission on the Audi Q3 features a new innovation. When the car is moving but not accelerating or braking, S tronic® disengages the clutch and allows the Q3 to roll freely (if Audi drive select is ordered and efficiency mode is selected). This enhancement helps to save even more fuel.



Efficiency

At Audi, doing less is something we're trying to do more of. We're working to use less fuel, release less CO₂ and waste less energy. It's why we've incorporated a number of more efficient technologies into the Audi Q3.

Recuperation

When a vehicle brakes, the discs convert the kinetic energy into thermal energy, which is wasted as it cannot be used. With a recuperation system like the one in the Audi Q3, the kinetic energy is converted into useful electrical energy. The way it works is simple. While the car is coasting or braking, the alternator voltage is raised above the level of the basic electrical system, which enables the alternator to generate electrical energy and store it temporarily in the battery. When the vehicle accelerates, this energy is used to relieve the load on the alternator, resulting in a fuel saving of up to 3%.





Aerodynamics

A car's shape can have a big impact on its efficiency. It's why we've worked to make the Audi Q3 as aerodynamic as possible.

Automatic Start-Stop function

In heavy traffic, your car still uses fuel and releases CO₂, even when it's stationary. The automatic Start-Stop function counteracts this problem by switching off the engine when your car comes to a standstill. As soon as you touch the clutch or release the brake, the car restarts. The Start-Stop function comes as standard on all Q3 engines and transmissions and it helps save up to 0.2 litres of fuel every 100km.

quattro®

It's the technology that has given us the edge on the rally circuit ever since it was first introduced over 30 years ago, bringing victory for the Audi quattro on its very first outing. It's called quattro® permanent all-wheel-drive. In this system, four permanently driven wheels deliver better acceleration, road-holding and safety, while asymmetric dynamic torque distribution intelligently controls the flow of power to the front and rear axles.

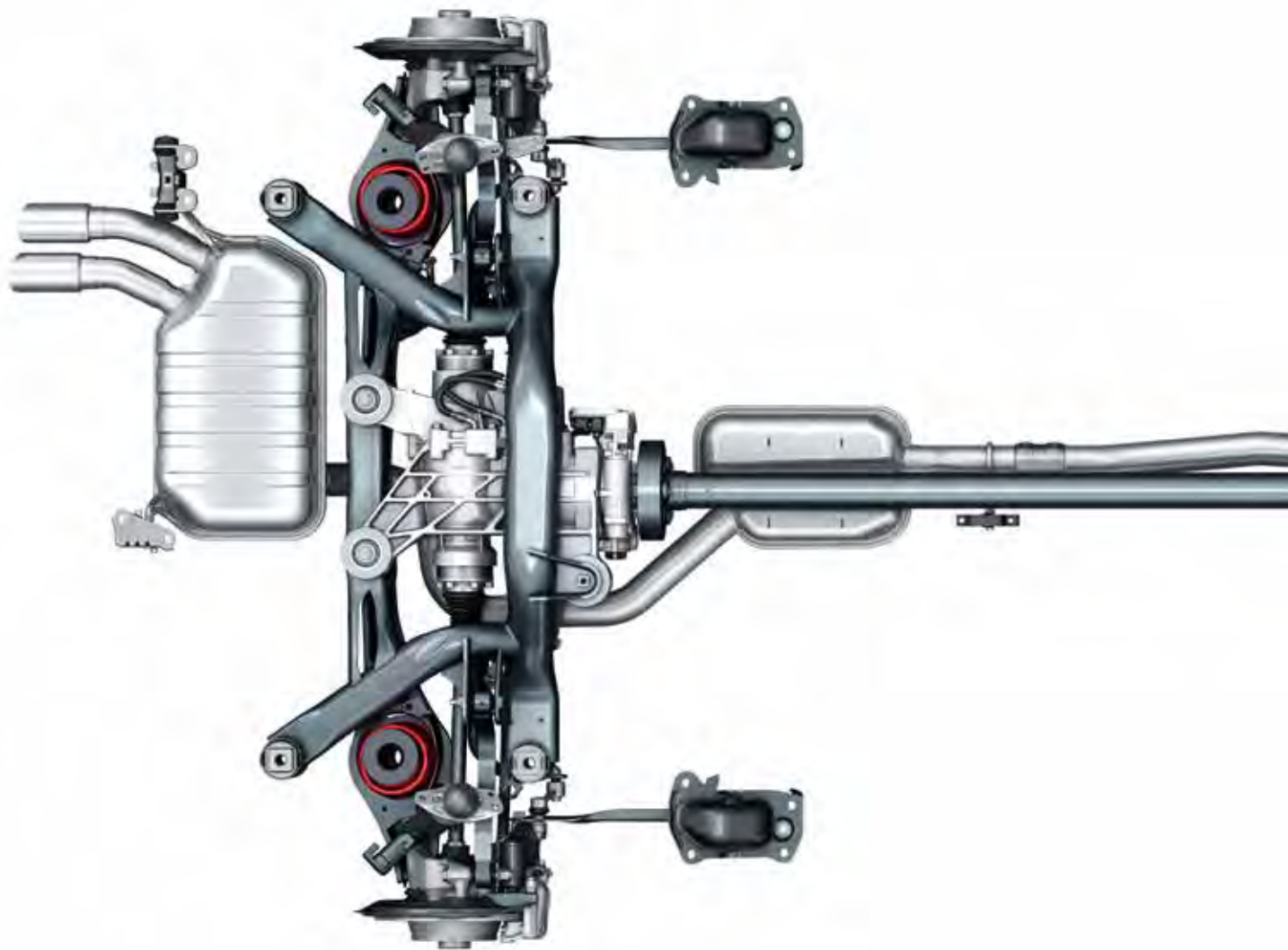

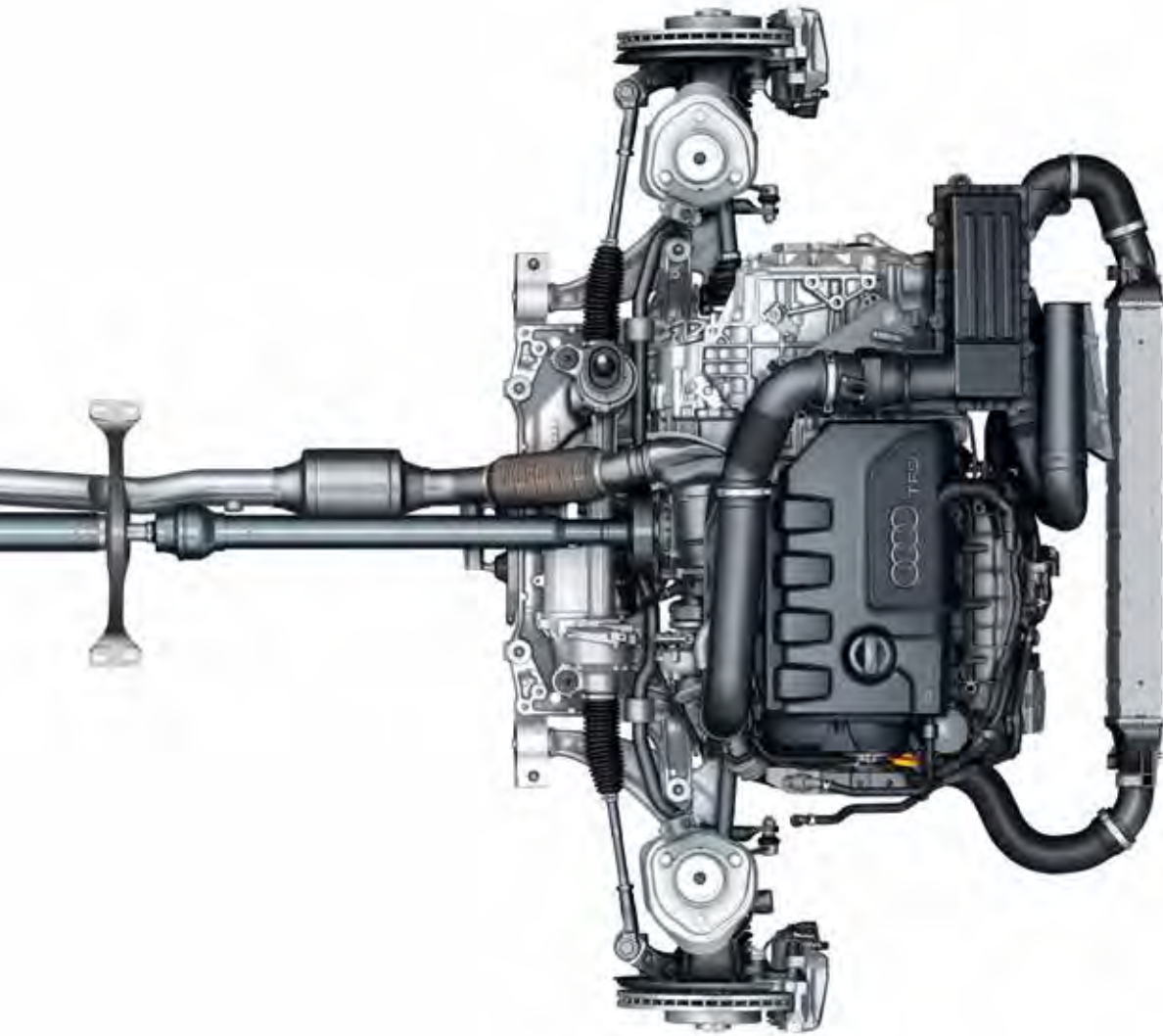

It means that the Audi Q3 can 'read' the road, sensing changes in the surface beneath the wheels and adjusting their grip accordingly. So when conditions get a little more demanding – in particular, when you go off-road – quattro® adapts, putting all the force of the Q3's engine precisely where it's needed to handle the change in terrain.





SE model equipment

All Audi Q3 SE models have the following items of standard equipment

Engine and transmission

Efficiency program in the Driver's Information System (DIS) – provides the driver with fuel-saving tips and a gear-change indicator on manual and S tronic models

Start-Stop system with energy recuperation

Wheels, tyres and suspension

17" x 7J '10-spoke' design alloy wheels with 235/55 R17 tyres

Anti-theft wheel bolts

Dynamic suspension

Electromechanical parking brake – includes parking brake function when the car is stationary, auto-release function to assist when pulling away and emergency braking function on all four wheels

Space-saving spare wheel – for temporary use, radial tyre (5-hole)

Audio and communication

6.5" display screen – manually retractable

8 passive speakers in total, front and rear, with a total output of 80 Watts

Audi Music Interface (AMI) – provides connection to Apple iPod from 4th generation and Apple iPhone, as well as USB storage media and MP3 players

Bluetooth interface – for handsfree mobile phone connectivity and Bluetooth audio streaming (depending on compatibility of mobile phone)

Concert radio which includes:

- Single CD drive and two SDHC memory card readers (up to 32GB) which are MP3, WMA and AAC compatible
- MMI operating logic
- Speed-dependent volume control (GALA)
- TP memo – automatically saves traffic news when driving

Driver's Information System (DIS) –

3.5" monochrome display in the dashboard binnacle. The DIS shows the radio frequency/station or track title, telephone control menu and other display information from the infotainment system such as navigation (if fitted). Also includes an on-board trip computer with short and long-term trip memory, outside temperature display, digital speedometer, door or boot open warning and efficiency program

Preparation for SD card based navigation system – allows maps to be retro-fitted using parts from Audi Genuine Accessories

Voice control system – for key telephone and radio functions



Interior equipment

4-spoke leather-trimmed multi-function steering wheel (with gear-shift paddles on S tronic models)

Cloth headlining

Door sill trims with aluminium inlays

Dual-zone electronic climate control – temperatures can be selected separately by driver and front passenger and the system will electronically control the air temperature, volume and distribution. Includes separate defroster button for de-icing the windscreen and side windows more quickly, air vents for the rear compartment in the rear centre console and a ventilated glove box

Electric windows, front and rear

Front and rear floor mats in velour, to match the chosen carpet colour

Front centre armrest which can be moved forwards/backwards with adjustable angle. Also includes folding storage compartment and a 12-Volt socket in the rear centre console

Inlays in monometallic platinum

(Truffle beige when combined with Pistachio beige upholstery)

Luggage compartment sill protection in stainless steel

Reversible luggage compartment floor – one side in high-quality velour, the other with a waterproof, hard-wearing plastic surface. Also includes additional storage compartments under the floor

Smoking package – includes ashtray with chrome-plated lid and a cigarette lighter in the centre console (non-smoking package is available at no charge)

Steering wheel adjustable for height and reach

Washer fluid level indicator

Safety and security

Driver, front passenger, front side and head airbag system with front passenger airbag deactivation switch

Electronic Stability Programme (ESP) – includes ABS, EBD, ASR and EDL

First aid kit

Front and rear fog lights

Light and rain sensor – automatically switches the dipped beam headlights and windscreen wipers on/off depending on the light and rain conditions. Also includes coming home/leaving home function which delays the deactivation of the front and rear lights after locking and automatic activation of the lights when unlocking

Rear parking sensors – facilitate parking by acoustically indicating the distance to obstacles; measurement is by ultrasonic sensors integrated discreetly into the bumper

Remote central locking with two foldaway keys

Seat belt monitoring

Thatcham Category 1 alarm and immobiliser

Tool kit and car jack

Warning triangle



Door sill trims with Aluminium inlays*



Front centre armrest**



Driver, front passenger, front side and head airbag system

* Image also shows Electric front seats which is available at additional cost

**Image also shows front Sports seats in Titanium grey which are available at additional cost

SE model equipment

(continued)

Seats

ISOFIX child seat mounting for front passenger (with airbag deactivation) and outer rear seats including electric child locks for the rear doors

Split-folding rear seats

Standard seats in 'Initial' cloth upholstery – include manual adjustment for driver and front passenger seat height, forwards and backwards position, backrest angle, head restraints and seat-belt height

Exterior equipment

Aluminium roof rails

Aluminium window trims framing the exterior side windows and the outer B and C-pillar trims in high-gloss black

Body-coloured door mirrors – electrically adjustable and heated with integrated LED indicator signals

Contrasting anthracite metallic finish on the front and rear bumpers, wheel arch trims and lower door trims

Halogen headlights with electric headlight range control and daytime-running lights

Heated windscreen washer jets

Tow-bar bracket preparation – includes the wiring to the spare wheel well, control unit and adapted engine cooling. The set of parts for retrofitting is available from Audi Genuine Accessories

Windscreen with sunband for improved insulation of the windscreen and acoustic glass for reduced outside noise



Split-folding rear seats



Halogen headlights



Image shows the Q3 SE model with optional Ice silver, metallic paint (P5) and Xenon light package (WB6)

S line model equipment

In addition to SE model equipment

Basic RRP
£2,291.67

Total RRP inc VAT
£2,750.00

Wheels, tyres and suspension

18" x 7J '5-double-spoke' design alloy wheels with 235/50 R18 tyres

Dynamic suspension (S line Sports suspension, lowered by 20mm, is available as a no cost option)

Seats

Front Sports seats – including electric lumbar support

Seats upholstered in black 'Sprint' cloth/leather with embossed S line logo in the front seat backrests

Interior equipment

3-spoke leather-trimmed multi-function Sports steering wheel with S line badge and gear-shift paddles on S tronic models

Cloth headlining and dashboard in black

Door sill trims with S line logo

Gear knob in perforated leather

Inlays in matt-brushed aluminium

Exterior equipment

Chrome-plated trims for exhaust tailpipes

Fog-light surrounds in chrome

Full body-colour paint finish to the front and rear bumpers, wheel arch trims and lower door trims

Radiator grille with chrome vertical bars

S line badges on the front wings

S line body styling comprising:

- S line front and rear bumpers and door trim strips
- Diffuser insert and centre front spoiler lip painted in Platinum grey

Xenon Plus headlights with automatic/dynamic headlight range control, LED daytime-running lights strip and headlight washers. Also includes rear lights, brake lights and rear indicators all featuring LED technology



18" x 7J '5-double-spoke' design alloy wheels



3-spoke leather-trimmed multi-function Sports steering wheel with S line badge



Xenon Plus headlights with LED daytime-running lights strip



Image shows the Q3 S line model with optional Ice silver, metallic paint (P5)

Audi Q3 SE

Engines	Power	Transmissions	CO ₂ g/km	Basic RRP	Total RRP inc VAT	Recommended OTR
2.0 TFSI quattro	170PS	6-speed manual	174	£21,233.33	£25,480.00	£26,410.00
2.0 TFSI quattro	170PS	7-speed S tronic	179	£22,466.67	£26,960.00	£27,940.00
2.0 TFSI quattro	211PS	7-speed S tronic	179	£23,625.00	£28,350.00	£29,330.00
2.0 TDI	140PS	6-speed manual	137	£20,416.67	£24,500.00	£25,270.00
2.0 TDI quattro	140PS	6-speed manual	149	£21,608.33	£25,930.00	£26,715.00
2.0 TDI quattro	140PS	7-speed S tronic	152	£22,841.67	£27,410.00	£28,230.00
2.0 TDI	177PS	6-speed manual	144	£21,200.00	£25,440.00	£26,225.00
2.0 TDI quattro	177PS	6-speed manual	148	£22,391.67	£26,870.00	£27,655.00
2.0 TDI quattro	177PS	7-speed S tronic	156	£23,625.00	£28,350.00	£29,170.00

Audi Q3 S line

Engines	Power	Transmissions	CO ₂ g/km	Basic RRP	Total RRP inc VAT	Recommended OTR
2.0 TFSI quattro	170PS	6-speed manual	174	£23,525.00	£28,230.00	£29,160.00
2.0 TFSI quattro	170PS	7-speed S tronic	179	£24,758.33	£29,710.00	£30,690.00
2.0 TFSI quattro	211PS	7-speed S tronic	179	£25,916.67	£31,100.00	£32,080.00
2.0 TDI	140PS	6-speed manual	137	£22,708.33	£27,250.00	£28,020.00
2.0 TDI quattro	140PS	6-speed manual	149	£23,900.00	£28,680.00	£29,465.00
2.0 TDI quattro	140PS	7-speed S tronic	152	£25,133.33	£30,160.00	£30,980.00
2.0 TDI	177PS	6-speed manual	144	£23,491.67	£28,190.00	£28,975.00
2.0 TDI quattro	177PS	6-speed manual	148	£24,683.33	£29,620.00	£30,405.00
2.0 TDI quattro	177PS	7-speed S tronic	156	£25,916.67	£31,100.00	£31,920.00

Please note: The maximum power output figures are quoted in PS (or Pferdestärke, which is the metric equivalent of brake horsepower). To convert to brake horsepower, divide the PS figure by 1.0139.

Recommended On-The-Road (OTR) retail prices include: delivery charge, half a tank of fuel, number plates at £590.00 (inc. VAT), Road Fund Licence (which may vary depending on model/transmission – see page 75 for details) and first registration fee at £55.00. Vehicle Excise Duty correct at time of going to print, but this may alter to reflect any change in the applicable VED rate.

RRP – Recommended Retail Price. VAT is calculated at 20% but this may alter to reflect any change in the applicable VAT rate.





Audi exclusive

Every Audi is intrinsically exclusive. It's the breathtaking design, the exceptional engineering, the Vorsprung durch Technik. But for that special touch, you can specify your new Q3 with options from Audi exclusive. Whether you want a unique, custom-mixed paint colour or seats in a combination of complementary shades, Audi exclusive will enable you to drive the car you've always imagined.

Both the exclusive and standard options can be found on the following pages.



Paint

We believe that every part of your car should have a personal touch, which is why you can choose from a wide range of paint colours and finishes, from standard shades to metallic and pearl effects. We can even mix a customised colour for you to create the perfect fit.

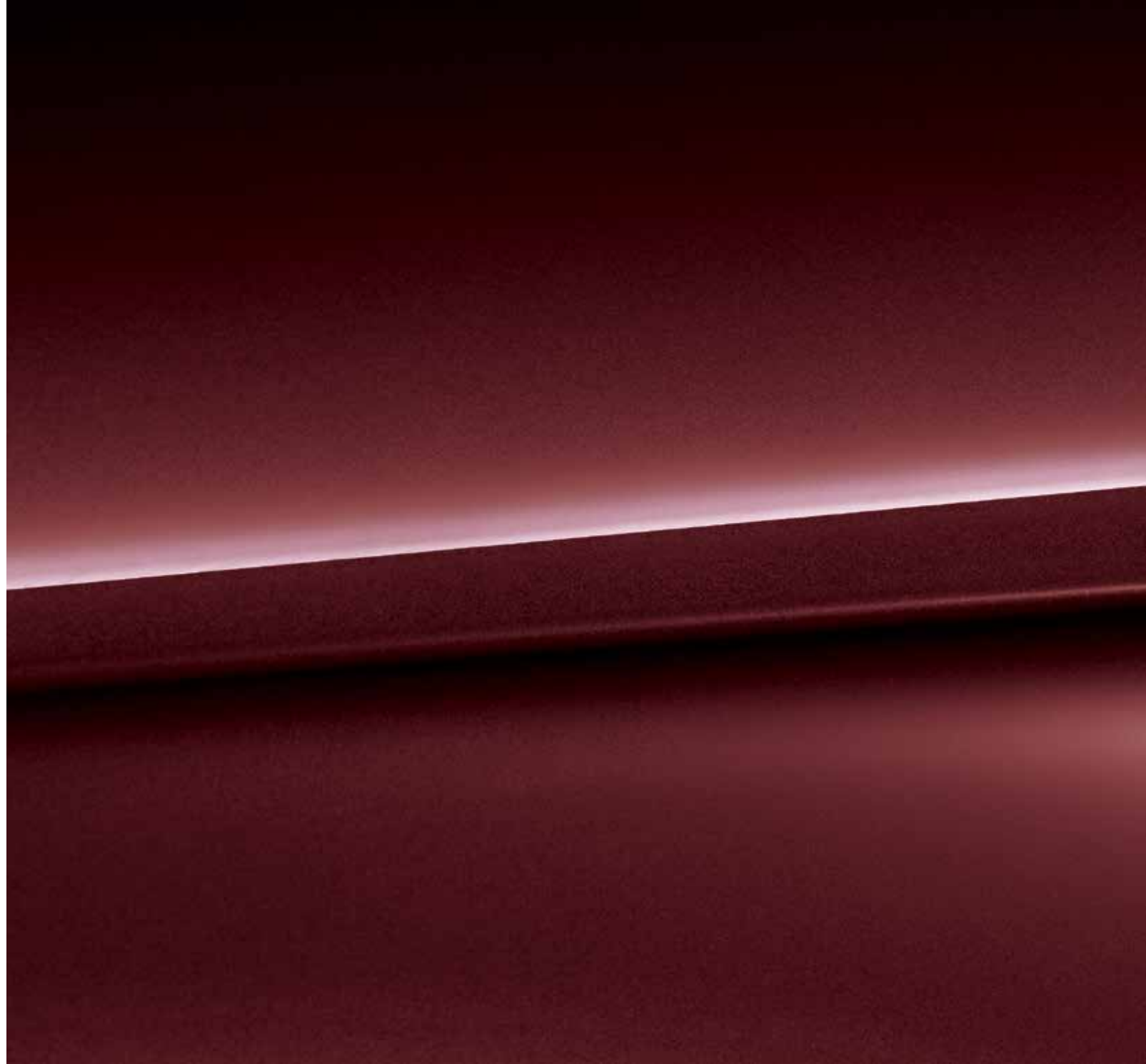

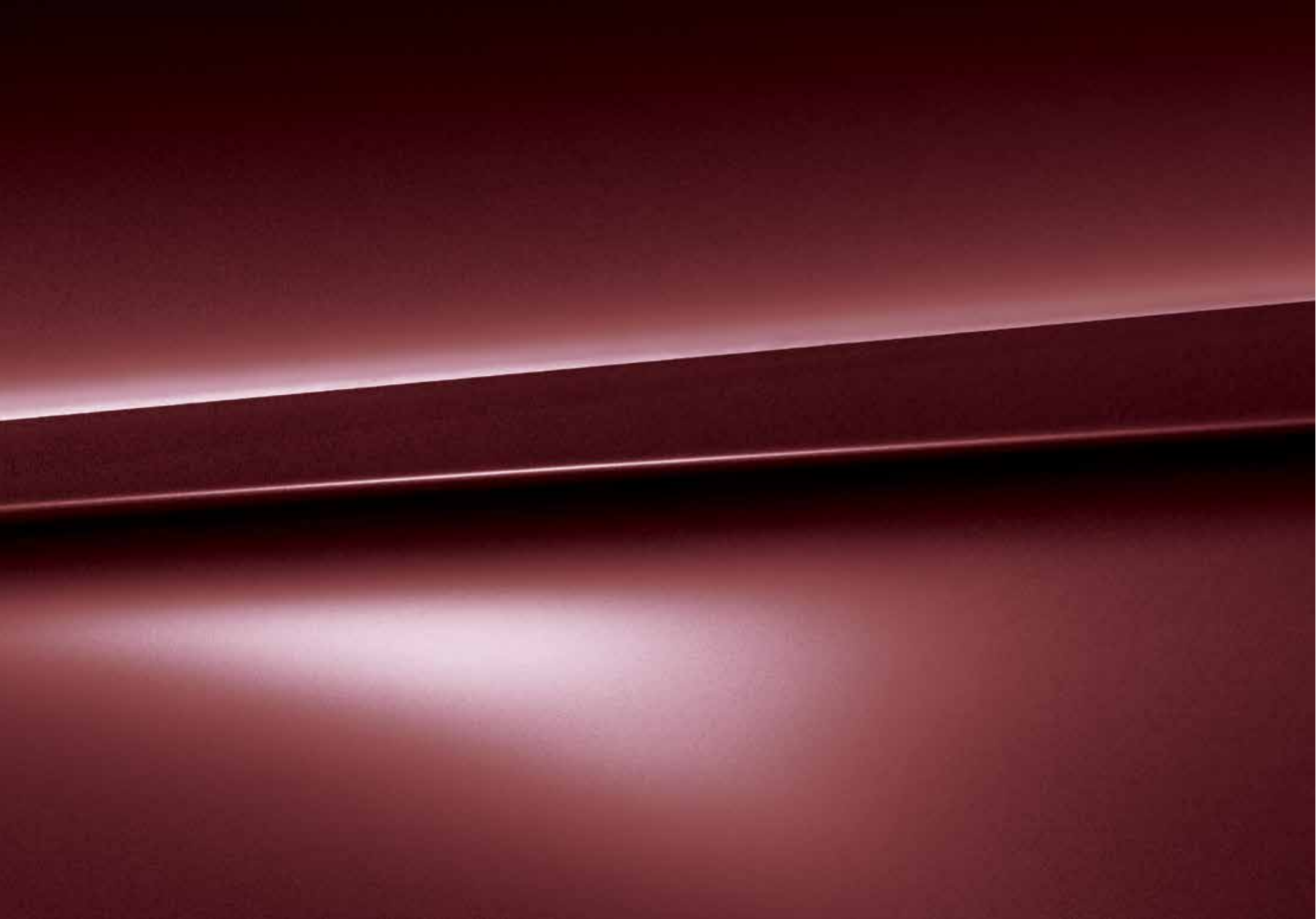

Paint

You can select one of the standard colours shown opposite or, for a different look, choose from a range of optional finishes.

Standard colours



Amalfi white - Y5

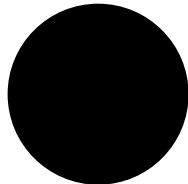

Brilliant black - A2

Optional colours

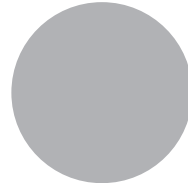

Ice silver, metallic - P5

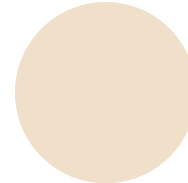

Platinum beige, metallic - L7

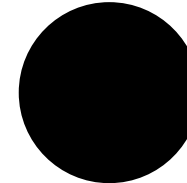

Phantom black, pearl effect - L8

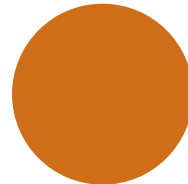

Samoa orange, metallic - J0

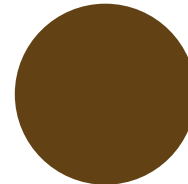

Caribou brown, metallic - 6M

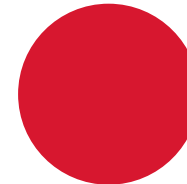

Misano red, pearl effect - N9*

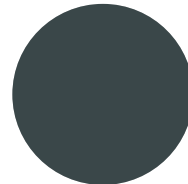

Monsoon grey, metallic - 0C*

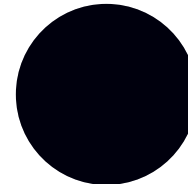

Cobalt blue, metallic - 5F



Glacier white, metallic - 2Y

S line colour

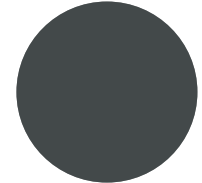

Daytona grey, pearl effect - 6Y

*Can only be ordered in combination with full paint finish VJ1 for an additional £100 RRP on SE models.

All the colour swatches on this page are matched as accurately as possible to the actual paint colours used. However, due to print processes, Audi UK cannot guarantee that colours shown are 100% accurate.

Visit your local Audi Centre for a more accurate colour swatch.

Options are subject to availability and may extend delivery.

RRP - Recommended Retail Price.

VAT is calculated at 20% but this may alter to reflect any change in the applicable VAT rate.

Optional colours

Basic RRP
£437.50

Total RRP inc VAT
£525.00

S line colour

Basic RRP
£437.50

Total RRP inc VAT
£525.00

Paint

Audi exclusive

Everyone has a favourite colour. No matter what yours is, Audi exclusive provides a range of unique colours that have been designed to set your car apart. Choose from the swatches here, or specify any other paint colour in the Audi range. Whether it's Sepang blue from the Audi R8 or Alpine white from the original Audi quattro, the choice is yours.

Customised

If you have a particular colour in mind, we'll mix the exact metallic or pearl-effect shade you want. *

*Customised paint is subject to factory approval, and is available for metallic and pearl-effect water-based paints only. Three-colour process colours and two-tone schemes are not available.

**Visit your local Audi Centre for colour samples.

All the colour swatches on this page are matched as accurately as possible to the actual paint colours used. However, due to print processes, Audi UK cannot guarantee that colours shown are 100% accurate.

Visit your local Audi Centre for a more accurate colour swatch.

RRP - Recommended Retail Price.

VAT is calculated at 20% but this may alter to reflect any change in the applicable VAT rate.

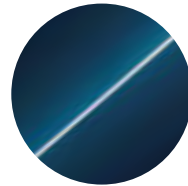

Palace blue, pearl effect

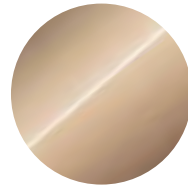

Sand beige, pearl effect

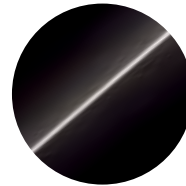

Saddle brown, pearl effect

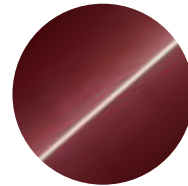

Classic red, pearl effect

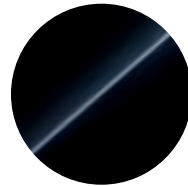

Mamba black, metallic

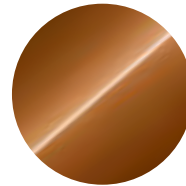

Ipanema brown, metallic



Any colour in the Audi range or 100 exclusive colours to choose from**



Customised paint

Audi exclusive

Basic RRP
£1,687.50

Total RRP inc VAT
£2,025.00

Customised*

Basic RRP
£2,104.17

Total RRP inc VAT
£2,525.00

Upholstery

It's important to feel comfortable on the road. Just choose from our range of luxury upholstery materials and textures, including additional support and colour options, for complete relaxation while you drive.











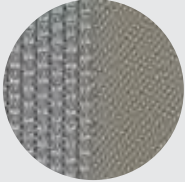

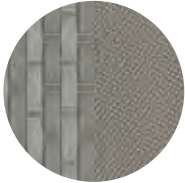
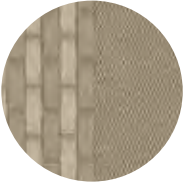
Upholstery

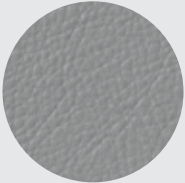
Standard seats

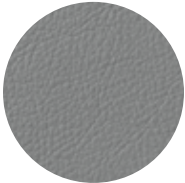
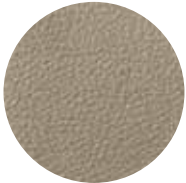
Choose your favourite upholstery from the swatches shown opposite to give your car's interior the look and feel you want.

	SE	S line	Basic RRP	Total RRP inc VAT
Initial cloth (NOL)  Black/Brown - FZ  Titanium grey - VL	S	-	No charge	No charge
Style cloth (N2P)  Black - FZ  Titanium grey - VL  Pistachio beige - VS	•	-	£125.00	£150.00
Milano leather (N5W)  Black - FZ  Titanium grey - VL	•	-	£875.00	£1,050.00
Fine Nappa leather (N3Q)  Black - FZ  Titanium grey - VL  Pistachio beige - VS  Chestnut brown - VR  Chennai brown - TZ	•	-	£1,041.67	£1,250.00

Options are subject to availability and may extend delivery.

- = Not available
 • = Available
 S = Standard

RRP - Recommended Retail Price.

VAT is calculated at 20% but this may alter to reflect any change in the applicable VAT rate.

Upholstery

Q3 SE models

Options are subject to availability and may extend delivery.

- = Not available
• = Available
S = Standard

*Upholstery shown is not available in the UK. Image shown also includes optional under-seat storage which is part of the storage package, available at additional cost.

RRP - Recommended Retail Price.

VAT is calculated at 20% but this may alter to reflect any change in the applicable VAT rate.



Standard seat*

Upholstery

Front Sports seats – PS1

With prominent side bolsters for better lateral support when cornering and electric lumbar support for driver and front passenger. Manual height adjustment, manually adjustable seat cushion angle and extendable thigh rest.

Options are subject to availability and may extend delivery.







- = Not available
- = Available
- S = Standard

All leather upholstery choices include seats, head restraints, front centre armrest and door panels in leather.

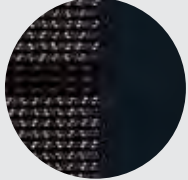
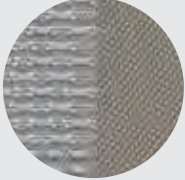
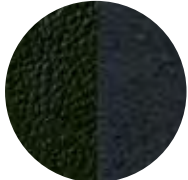
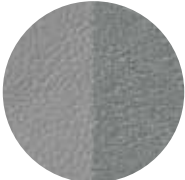
Alcantara/leather includes head restraints, seat side bolster and front centre armrest in leather with the seat centres and door panels in Alcantara.

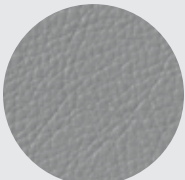
RRP – Recommended Retail Price.

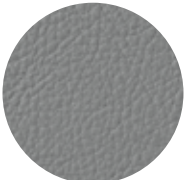
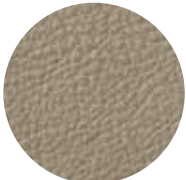
VAT is calculated at 20% but this may alter to reflect any change in the applicable VAT rate.

	SE	S line	Basic RRP	Total RRP inc VAT
Sport cloth (NSF/PS1)  Black/Silver – FZ  Titanium grey – VL	•	–	£333.33	£400.00
Alcantara/leather (N7U/PS1)  Black – FZ  Titanium grey – VL	•	–	£995.83	£1,195.00
Milano leather (N5W/PS1)  Black – FZ  Titanium grey – VL	•	–	£1,208.33	£1,450.00
Fine Nappa leather (N3Q/PS1)  Black – FZ  Titanium grey – VL  Pistachio beige – VS  Chestnut brown – VR  Chennai brown – TZ	•	–	£1,375.00	£1,650.00

Upholstery

Q3 Sport models

Options are subject to availability and may extend delivery.

- = Not available
• = Available
S = Standard

*Image shown also includes optional electric front seats and under-seat storage contained in storage package, both of which are available at additional cost.

RRP - Recommended Retail Price.

VAT is calculated at 20% but this may alter to reflect any change in the applicable VAT rate.



Sports seat*

Upholstery

S line Sports seats with S line embossing

With electric lumbar support.

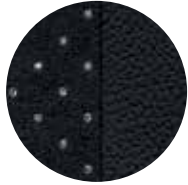
	SE	S line	Basic RRP	Total RRP inc VAT
Sprint cloth/Leather (N7V)  Black - QZ	-	S	No charge	No charge
Perforated Alcantara/Leather (N7K)  Black - QZ	-	•	£404.17	£485.00
Fine Nappa Leather (N2R)  Black - QE	-	•	£662.50	£795.00

Options are subject to availability and may extend delivery.

- = Not available
- = Available
- S = Standard

All leather upholstery choices include seats, head restraints, front centre armrest and door panels in leather.

Alcantara/leather includes head restraints, seat side bolster and front centre armrest in leather with the seat centres and door panels in Alcantara.

RRP - Recommended Retail Price.

VAT is calculated at 20% but this may alter to reflect any change in the applicable VAT rate.



S line Sports seats with Sprint cloth/leather upholstery

Colour and trim guide

Interior trim colours

Standard seats

To help you choose the right interior for your Audi Q3, please use this guide showing the carpet, dashboard and headlining colours that have been matched to your chosen upholstery.

Front Sports seats – PS1

S line Sports seats with S line embossing

*Black/Jet grey stitching on seats, steering wheel, gear-lever gaiter and floor mats.

Options are subject to availability and may extend delivery.

– = Not available
● = Available
S = Standard

Order code	Upholstery	Carpet	Dashboard (upper/lower)	Headlining	Initial cloth (N0L)	Style cloth (N2P)	Milano leather (N5W)	Fine Nappa leather (N3Q)
FZ	Black/Brown	Black	Black/Black	Lunar silver	●	–	–	–
FZ	Black	Black	Black/Black	Lunar silver	–	●	●	●
TZ	Chennai brown	Black	Black/Black	Black	–	–	–	●
VL	Titanium grey	Black	Black/Titanium grey	Lunar silver	●	●	●	●
VR	Chestnut brown	Black	Black/Black	Lunar silver	–	–	–	●
VS	Pistachio beige	Truffle beige	Truffle beige/Pistachio beige	Silk beige	–	●	–	●

Order code	Upholstery	Carpet	Dashboard (upper/lower)	Headlining	Sport cloth (NSF/PS1)	Milano leather (N5W/PS1)	Fine Nappa leather (N3Q/PS1)	Alcantara/leather (N7U/PS1)
FZ	Black/Silver	Black	Black/Black	Lunar silver	●	–	–	–
FZ	Black	Black	Black/Black	Lunar silver	–	●	●	●
TZ	Chennai brown	Black	Black/Black	Black	–	–	●	–
VL	Titanium grey	Black	Black/Titanium grey	Lunar silver	●	●	●	●
VR	Chestnut brown	Black	Black/Black	Lunar silver	–	–	●	–
VS	Pistachio beige	Truffle beige	Truffle beige/Pistachio beige	Silk beige	–	–	●	–

Order code	Upholstery	Carpet	Dashboard (upper/lower)	Headlining	Sprint cloth/leather (N7V)	Fine Nappa leather (N2R)	Perforated Alcantara/leather (N7K)
QE	Black	Black	Black/Black	Black	–	●	–
QZ*	Black with Jet grey stitching	Black	Black/Black	Black	●	–	●

Seats

Choose from a variety of different seat options so you can maintain the right driving posture at all times.

Order Code		SE	S line	Basic RRP	Total RRP inc VAT
4A3	Heated front seats. Individually controlled variable temperature adjustment for driver and front passenger seats	●	●	£216.67	£260.00
3H1	Folding front passenger seat. Allows longer objects to be transported in the Audi Q3 up to a length of approximately 2.5 metres – cannot be ordered in conjunction with front Sports seats (PS1), electric lumbar support (7P1) or electric front seats (PV1)	●	–	£108.33	£130.00
7P1	Electric lumbar support. For front seats with horizontal and vertical adjustment	●	S	£162.50	£195.00
PV1	Electric front seats. Includes adjustment for height, forwards and backwards position, backrest angle and lumbar support	●	●	£637.50	£765.00
3NU	Through-load facility. For safely transporting long objects. Includes rear centre armrest with cup holders	●	●	£145.83	£175.00
3X2	Ski/snowboard bag. A practical way to hold sports equipment. Only in combination with through-load facility	●	●	£58.33	£70.00

Options are subject to availability and may extend delivery.

- = Not available
- = Available
- S = Standard



Electric front seats



Folding front passenger seat

Upholstery

Audi exclusive

With Audi exclusive, you can specify your seats in an array of different colours shown to the right.

Select just one all-over shade for each seat, or customise each panel in two or more complementary colours from the distinctive Audi exclusive palette. You can even choose the colour of the decorative stitching – to match or contrast with your chosen upholstery.* Whatever combination you decide upon, we think you'll be extremely comfortable with the result.



Chestnut brown



Jet grey



Alabaster white

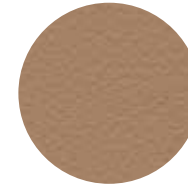

Sand beige

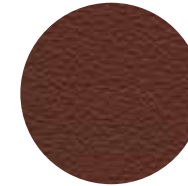

Saddle brown

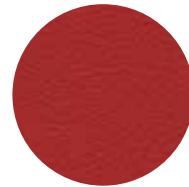

Crimson red



Magnolia white



Havanna brown

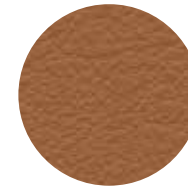

Cognac brown

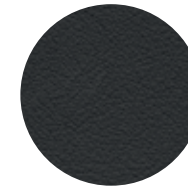

Night blue

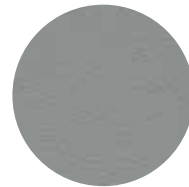

Cloudy grey

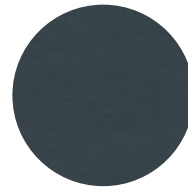

Smoky blue

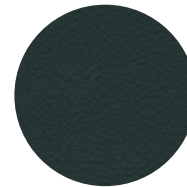

Iceland green

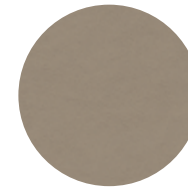

Powder beige

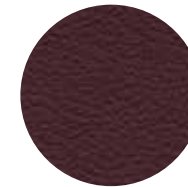

Classic red

*Due to safety considerations, contrast stitching is not available on the dashboard/windscreen side.

Also available:

Alcantara: available in all the Audi exclusive colours shown, except for Crimson red, Jet grey and Sand beige. Alcantara equivalents are Chilli red, Amethyst grey, and Sesame beige respectively.

Dashboard: available in Havanna brown, Saddle brown, Chestnut brown, Classic red, Crimson red, Jet grey, Night blue, Smoky blue and Iceland green.

Please consult your Audi Centre for examples of Alcantara and carpet colours.

Upholstery

Audi exclusive

Order Code		SE	S line	Basic RRP	Total RRP inc VAT
PYA S3G	Audi exclusive leather package 1 in Fine Nappa leather. Includes leather-covered seat upholstery, head restraints and front centre armrest in Fine Nappa leather, with colour-matched door trim inserts and floor mats with leather piping. There is also optional coloured stitching on seat side sections and head restraints. Black interior colour is recommended with this option	●	—	£2,512.50	£3,015.00
		—	●	£2,083.33	£2,500.00
PYC S3G	Audi exclusive leather package 1 in Alcantara/Fine Nappa leather. Includes leather-covered seat side section, head restraints and front centre armrest in Fine Nappa leather. Seat centre section and door trim inserts in Alcantara and floor mats with leather piping. There is also optional coloured stitching on seat side sections and head restraints. Black interior colour is recommended with this option. Only in combination with Sports seats (PS1) on SE trim	●	—	£2,512.50	£3,015.00
		—	●	£2,083.33	£2,500.00

Options are subject to availability and may extend delivery.

— = Not available
● = Available
S = Standard

RRP – Recommended Retail Price.

VAT is calculated at 20% but this may alter to reflect any change in the applicable VAT rate.

Inlays

Attention to detail can make a big impact. From contemporary Aluminium satellite to Walnut brown, our selection of inlays make the perfect finishing touch to your car's interior.





Inlays

Inlays are the all-important finishing touch that add flair and interest to your car's interior.

Order Code		SE	S line	Basic RRP	Total RRP inc VAT
5MA	Monometallic platinum (Monometallic truffle beige when interior colour Pistachio beige VS is ordered)	S	–	No charge	No charge
5MF	Aluminium satellite*	•	–	£170.83	£205.00
7TF	3D aluminium mesh*	•	–	£208.33	£250.00
5MR	Larch wood, natural dark brown* (with aluminium optics for centre console and electromechanical parking brake)	•	–	£250.00	£300.00
5MS	Walnut, balsamic brown*	•	–	£250.00	£300.00
5TG	Matt-brushed aluminium*	–	S	No charge	No charge

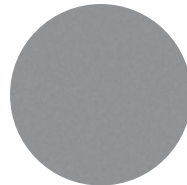

Monometallic platinum – **5MA**

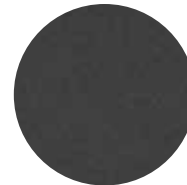

Monometallic truffle beige – **5MA**

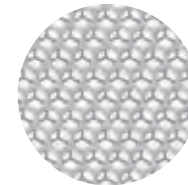

Aluminium satellite – **5MF**

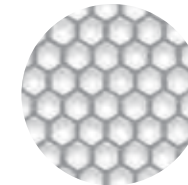

3D aluminium mesh – **7TF**

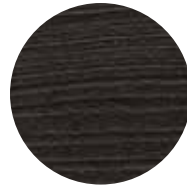

Larch wood, natural dark brown – **5MR**



Walnut, balsamic brown – **5MS**

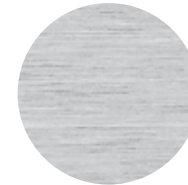

Matt-brushed aluminium – **5TG**

Options are subject to availability and may extend delivery.

– = Not available
• = Available
S = Standard

*Also includes elements in aluminium look on rotary light switch, cover on 12-Volt socket, electric window switches and mirror adjustment switch.

RRP – Recommended Retail Price.

VAT is calculated at 20% but this may alter to reflect any change in the applicable VAT rate.



Elements in aluminium-look on electric window switches and mirror adjustment

Inlays

Audi exclusive

Audi exclusive has sourced a wide range of materials which you can select for your inlays, from Oak sepia to Fine grain myrtle.

Order Code		SE	S line	Basic RRP	Total RRP inc VAT
YTA S3G	Audi exclusive inlays. Cannot be combined with inlays shown on page 48	●	I	£758.33	£910.00



Fine grain myrtle, nutmeg



Fine grain ash, nougat

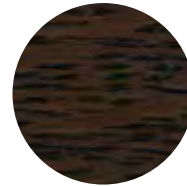

Oak, sepia



Vavona wood, bronze



Modrone wood, gold



Tamo ash, dark brown

Options are subject to availability and may extend delivery.

- = Not available
- = Available
- S = Standard

RRP - Recommended Retail Price.

VAT is calculated at 20% but this may alter to reflect any change in the applicable VAT rate.

Options

Every driver has different needs, which is why we have created some useful options to further enhance your car. For extra comfort, support, style or function, you can choose from a variety of additional features, tailoring everything from your infotainment and audio equipment to your wheels and lighting.





Wheels, tyres and suspension

Choose a set of specially-selected alloy wheels to subtly enhance the way your car looks and drives. And you can also specify Audi drive select, which allows you to change the engine and steering settings according to your driving style.



17" x 7J '10-spoke'
design alloy wheels - C2M



17" x 7J '5-arm Trias'
design alloy wheels - C2G



18" x 7J '5-arm'
design alloy wheels - C3I



18" x 7J '5-twin-spoke'
design alloy wheels - C2I



18" x 7J '5-double-spoke'
design alloy wheels - C3P



18" x 7J '5-arm Off-road'
design alloy wheels - C3Q



19" x 8.5J '5-double-spoke Off-road'
design alloy wheels - C7G



19" x 8.5J '5-segment-spoke'
design alloy wheels - C5E

Wheels, tyres and suspension

Order Code		SE	S line	Basic RRP	Total RRP inc VAT
C2M	17" x 7J '10-spoke' design alloy wheels with 235/55 R17 tyres	S	—	No charge	No charge
C2G	17" x 7J '5-arm Trias' design alloy wheels with 235/55 R17 tyres	●	—	£162.50	£195.00
C3I	18" x 7J '5-arm' design alloy wheels with 235/50 R18 tyres	●	—	£495.83	£595.00
C2I	18" x 7J '5-twin-spoke' design alloy wheels with 235/50 R18 tyres	●	—	£412.50	£495.00
C3P	18" x 7J '5-double-spoke' design alloy wheels with 235/50 R18 tyres	—	S	No charge	No charge
C3Q	18" x 7J '5-arm Off-road' design alloy wheels with 235/50 R18 tyres	—	●	£162.50	£195.00
C7G	19" x 8.5J '5-double-spoke Off-road' design alloy wheels with 255/40 R19 tyres	●	—	£1,208.33	£1,450.00
		—	●	£495.83	£595.00
C5E	19" x 8.5J '5-segment-spoke' design alloy wheels with 255/40 R19 tyres	●	—	£1,208.33	£1,450.00
		—	●	£495.83	£595.00
7K6	Tyre pressure monitoring system – a visual and acoustic warning when the system detects a loss of pressure in an individual tyre	●	●	£70.83	£85.00
2H6	Audi drive select – with four pre-configured modes (comfort, auto, dynamic and efficiency), allowing the driver to electronically adjust the engine, transmission and steering. The efficiency mode influences the behaviour of the following parts of the car to maximise efficiency: engine, transmission shift program for S tronic (or gear-change indicator with a manual gearbox), electromechanical power steering, dual-zone climate control and cruise control (where fitted)	●	●	£183.33	£220.00
1JT	Damper control – provides electronically controlled adjustment of the suspension to different situations. Comfort, auto, dynamic or efficiency modes can be selected. Only in combination with Audi drive select (2H6)	●	●	£566.67	£680.00
UC3	S line Sports suspension – lowered by 20mm with more firmly tuned springs and dampers for more direct contact with the road	—	●	No charge	No charge

Options are subject to availability and may extend delivery.

— = Not available
● = Available
S = Standard

RRP – Recommended Retail Price.

VAT is calculated at 20% but this may alter to reflect any change in the applicable VAT rate.

Packages

Some items work well together, which is why we've created these special packages. They provide increased convenience and value by combining several of our most popular options.

Options are subject to availability and may extend delivery.

- = Available
- = Not available
- S = Standard

RRP - Recommended Retail Price.

VAT is calculated at 20% but this may alter to reflect any change in the applicable VAT rate.

Order Code		SE	S line	Basic RRP	Total RRP inc VAT
WB4	Technology package - includes HDD-based MMI Satellite Navigation Plus and colour Driver's Information System (9Q8). HDD-based MMI Satellite Navigation Plus includes the following: navigation data saved on hard disk drive, high-resolution 7" colour display screen with high-quality map view. Map with topographical shading and many points of interest and city models shown in 3D. A choice of three alternative routes can be selected where possible. Includes a rotary button with integrated joystick function for searching in the map. Route information is displayed on a split screen (route instructions, points of interest along motorways, TMC traffic reports en route). Detailed intersection map and lane recommendations. Dynamic route guidance using TMC traffic information. Navigation address can be input using the voice control system. Route arrow instructions displayed in colour in the Driver's Information System. Includes full European map data and 7-digit postcode recognition. Also includes a hard disk drive jukebox function which can be used to store up to 20GB of music (MP3, WMA, AAC and MPEG4 compatible) and a DVD drive for playing music and video DVDs (when the car is stationary). The MMI Satellite Navigation Plus can be operated via the MMI controls, multi-function steering wheel or voice control system	•	•	£1,245.83	£1,495.00
WBI 7X4	Comfort package - includes Audi parking system plus, cruise control and auto-dimming rear-view mirror	•	•	£504.17	£605.00
WB6	Xenon light package - includes Xenon Plus headlights with automatic/dynamic headlight range control, LED daytime-running lights strip and headlight washers. Also includes rear lights, brake lights and rear indicators all featuring LED technology, adaptive headlights and LED interior light package	•	-	£958.33	£1,150.00



Xenon light package



Xenon light package

Packages

Order Code		SE	S line	Basic RRP	Total RRP inc VAT
VJ1	Full paint finish. Body-coloured paint finish to the lower section of the front and rear bumpers, wheel arch trims and lower door trims	●	S	£83.83	£100.00
PKQ	Audi exclusive off-road styling package. Includes Audi exclusive door sill trims, front and rear bumpers, side ventilation grilles, door capping strips and wheel arch trims in striking off-road design, stainless steel underbody guards on the front and rear bumpers and radiator grille with vertical chrome bars. Only in combination with 19" x 8.5J '5-double-spoke Off-road' design alloy wheels (C7G) or 19" x 8.5J '5-segment-spoke' design alloy wheels (C5E)	●	—	£1,495.83	£1,795.00

Options are subject to availability and may extend delivery.

- = Available
- = Not available
- S = Standard

RRP – Recommended Retail Price.

VAT is calculated at 20% but this may alter to reflect any change in the applicable VAT rate.



Audio and communication

Stay in touch using our range of communication functions, and give each journey its own soundtrack with our advanced audio equipment.

Order Code		SE	S line	Basic RRP	Total RRP inc VAT
9Q8	Colour Driver's Information System (DIS) with high-resolution 3.5" TFT colour display. Also available as part of the Technology package	●	●	£100.00	£120.00
9VD	Audi sound system , with 10 speakers including centre speaker in the dashboard and subwoofer beneath the luggage compartment floor. Total output of 180 Watts and 6-channel amplifier. Not available in conjunction with the option to increase boot volume to 460 litres (3GA/1G8)	●	●	£212.50	£255.00
9VK	BOSE® surround sound . Surround sound reproduction with 14 speakers including a centre speaker on the dashboard, a subwoofer beneath the luggage compartment floor and front door speakers with edges lit by LEDs. It also includes Audio Pilot for noise-dependent volume adjustment, 10-channel amplifier with a total output of 465 Watts, powerful and accurate bass reproduction which produces an outstanding overall listening experience. 5.1 surround sound reproduction is possible when ordered in conjunction with Technology package. Only in combination with LED interior light package (QQ1) or Xenon light package (WB6). Not available in conjunction with the option to increase boot volume to 460 litres (3GA/1G8)	●	●	£575.00	£690.00
PNU	Satellite Navigation system – SD card based . Route planning and guidance using voice, pictogram and 2D mapping shown on the 6.5" colour display screen. Can be operated via the MMI controls, multi-function steering wheel or voice control system. Includes European map data and 7-digit postcode recognition	●	●	£412.50	£495.00
7A2	CD changer in the luggage compartment for 6 CDs. MP3 and WMA compatible, shock-resistant, each CD can be loaded and changed individually	●	●	£270.83	£325.00
QU6	Digital TV reception . Receives digital (DVB-T) uncoded television stations (MPEG-2 standard), TV picture, teletext and Electronic Programme Guide (EPG). Facility to connect external AV sources via adaptor cable (available from Audi Genuine Accessories). Please note – TV reception depends on local digital network availability. No AV or TV video output when driving (audio output available). Only in combination with Technology package (WB4)	●	●	£725.00	£870.00

Options are subject to availability and may extend delivery.

-- = Not available
● = Available
S = Standard

RRP – Recommended Retail Price.

VAT is calculated at 20% but this may alter to reflect any change in the applicable VAT rate.



Colour Driver's Information System (DIS)



BOSE® surround sound

Audio and communication

Order Code		SE	S line	Basic RRP	Total RRP inc VAT
9ZF	Mobile telephone preparation – Low with Bluetooth. Provides handsfree connection via Bluetooth and includes an external aerial connection and charging facility for optimal mobile phone reception. To use the external aerial and charging facility, an optional cradle will be required at extra cost – please contact your Audi Centre for phone compatibility	●	●	£145.83	£175.00
9ZW	Mobile telephone preparation – High with Audi connect. Audi connect provides access to a number of innovative online services via an internal UMTS (3G) module. Audi connect online services include: navigation using Google Earth images and Google Street View, destination entry via Google Maps or myAudi, online point of interest search and information services such as weather forecasts and the latest world news. Audi connect also includes Audi traffic information online, which gives accurate real-time forecasts of the traffic situation along the chosen route. The traffic situation can be displayed on the navigation map or Google Earth image. Audi connect can also create a Wi-Fi hotspot in the car for convenient internet access using a mobile device (e.g. laptop or tablet). Many Audi connect features can be simply operated via MMI Navigation Plus, the multi-function steering wheel or the voice control system. Only in combination with Technology package. Important connectivity information: An external data source is required to enable the Audi connect online services. One of the two following external data sources can be used ¹ : 1. A mobile telephone with Bluetooth SIM Access Profile? 2. A separate SIM card which can be inserted in the included SIM card reader. When a separate SIM card is used, hands free phone calls are possible using the SIM card or by connecting a different mobile telephone via Bluetooth Hands Free Profile	●	●	£291.67	£350.00

Options are subject to availability and may extend delivery.

- = Not available
- = Available
- S = Standard

¹Online services are only available for mobile phone contracts or SIM cards which include a data option and only within the coverage of the mobile phone network; there may be additional costs for the use of these services (charges and billing correspond to the personal mobile phone contract or SIM card contract). Due to high data volumes, a mobile phone contract including an unlimited or high usage data plan is strongly recommended. The content and scope of the online based services offered may vary.

²To check the compatibility of your mobile phone and whether it has SIM Access Profile compatibility, please visit www.audi.co.uk/owners-area/phone-compatibility.html

RRP – Recommended Retail Price.

VAT is calculated at 20% but this may alter to reflect any change in the applicable VAT rate.

Interior equipment

Specify every detail of your car's interior with this range of exclusive options.

Options are subject to availability and may extend delivery.

-- = Not available
 ● = Available
 S = Standard

RRP – Recommended Retail Price.

VAT is calculated at 20% but this may alter to reflect any change in the applicable VAT rate.

Order Code		SE	S line	Basic RRP	Total RRP inc VAT
6Q6	Aluminium gear knob. Only available on manual models	●	●	£120.83	£145.00
4L6	Auto-dimming rear-view mirror. A light sensor detects when the headlights behind are too bright and dims the mirror automatically. Also available as part of the Comfort package	●	●	£245.83	£295.00
6SJ	Reversible luggage compartment mat. Velour on one side, rubber on the other, this mat folds out to cover the luggage compartment floor, the sill/bumper and the backs of the rear seats when folded down. Not available in conjunction with the option to increase boot volume to 460 litres (3GA/1G8)	●	●	£62.50	£75.00
3GA 1G8	Option to increase boot volume to 460 litres. Replaces space saver spare wheel with a tyre mobility kit and deletes the reversible luggage compartment floor. Not available with Technology package (WB4), Audi sound system (9VD), BOSE surround sound (9VK) or Reversible luggage compartment mat (6SJ)	●	●	No charge	No charge
6NQ	Cloth headlining in Black	●	S	£187.50	£225.00
QE1	Storage package. Comprising storage nets on front-seat backrests, storage compartments under both front seats, lockable glove box and multi-purpose hook in front passenger footwell	●	●	£83.33	£100.00
QE4	Luggage compartment package. Includes a stretch combi-net for fixing down objects into the luggage compartment, a 12V socket, a movable side net and a second luggage compartment light on the left	●	●	£70.83	£85.00
QQ1	LED interior light package. Glare-free illumination of the interior thanks to energy-saving, durable LED technology. Consists of ambient light LED located in the interior light control unit, door sill illumination, vanity mirrors, storage compartment in the centre console and cup holders. Also features lighting for the door pockets, footwells, inside door handles, uplit centre console and door inner panels and active door reflectors. Also available as part of the Xenon light package	●	●	£204.17	£245.00
9JA	Non-smoking package. Replaces ashtray and cigarette lighter with a 12V socket and a centre storage compartment	●	●	No charge	No charge



LED interior light package



Reversible luggage compartment floor

Exterior equipment

Make sure your car looks exactly as you want it to by selecting some of the striking exterior options from our detailed list.

Options are subject to availability and may extend delivery.

- = Not available
- = Available
- S = Standard

RRP – Recommended Retail Price.

VAT is calculated at 20% but this may alter to reflect any change in the applicable VAT rate.

Order Code		SE	S line	Basic RRP	Total RRP inc VAT
3FU	Panoramic glass sunroof. Two-piece; the front glass element with electric slide-and-tilt control and electric sunblind for front and rear passengers. Automatic close function from outside via the remote central locking. Provides added light and improved air extraction. Only in combination with LED interior lighting package (QQ1) or Xenon light package (WB6)	•	•	£916.67	£1,100.00
4F2	Advanced key. Access and authorisation system which automatically exchanges data between key and vehicle, allowing the driver to keep the key in their pocket or bag at all times. To unlock and open, simply lift the exterior door handle. To lock, press the button on the handle. Also includes an ignition start/stop button integrated in the centre console to start and stop the engine	•	•	£354.17	£425.00
4KF	Privacy glass. Dark tinted rear and rear-side windows from B-pillar backwards	•	•	£300.00	£360.00
4ZD	Audi exclusive black styling package. Radiator grille frame, window trims and fog-light surrounds in high-gloss black with radiator grille and number plate holder in matt black. Only in combination with Black roof rails	•	•	£329.17	£395.00
3S2	Black roof rails	•	•	No charge	No charge
2Z0	Deletion of model and technology designation at rear	•	•	No charge	No charge
2Z7	Deletion of technology designation at rear	•	•	No charge	No charge
1D4	Towing equipment – ball rod and ball coupling. The ball coupling swings out mechanically and is operated manually via a Bowden cable. Includes an indicator lamp on the Bowden cable and a display in the instrument cluster for checking if the tow bar has locked into place correctly. Also includes a trailer stabilisation programme in the Electronic Stability Programme (ESP)	•	•	£520.83	£625.00
6XE	Door mirrors – electrically adjustable, folding and heated. Also includes an automatic kerb view dipping function when reverse gear is selected	•	•	£125.00	£150.00
6XK	Door mirrors – auto-dimming on the driver’s side, electrically adjustable, folding and heated. Must be combined with auto-dimming rear-view mirror (4L6) or Comfort package (WB1). Also includes an automatic kerb view dipping function on the passenger side when reverse gear is selected	•	•	£208.33	£250.00



Panoramic glass sunroof



Panoramic glass sunroof



Safety and security

Intelligent technology designed to give you better all-round awareness and safety on the road.

Options are subject to availability and may extend delivery.

- = Not available
• = Available
S = Standard

RRP – Recommended Retail Price.

VAT is calculated at 20% but this may alter to reflect any change in the applicable VAT rate.

Order Code		SE	S line	Basic RRP	Total RRP inc VAT
7X4	Audi parking system plus. Acoustic and visual parking aid for the front and rear of the vehicle with on-screen display of distance remaining from obstacles using a graphical representation. Measurement is by ultrasonic sensors integrated discreetly into the bumpers. Also available as part of the Comfort package	•	•	£208.33	£250.00
7X5	Audi parking system plus with park assist. Searches for suitable parking spaces along the road by means of ultrasonic sensors, calculates the ideal parking path and performs the steering action automatically. Park assist performs both parallel and perpendicular parking, as well as manoeuvring out of parallel parking spaces. The steering is done by the vehicle – the driver only needs to accelerate and apply the brakes	•	•	£416.67	£500.00
		In combination with Comfort package	•	•	£208.33
7X8	Audi parking system advanced with rear reversing camera. Aids parking by acoustically and visually indicating distances to obstacles with guiding lines. Measured by sensors and a rear reversing camera	•	•	£541.67	£650.00
		In combination with Comfort package	•	•	£333.33
8A3	Audi parking system advanced with rear reversing camera and park assist. Searches for suitable parking spaces along the road by means of ultrasonic sensors, calculates the ideal parking path and performs the steering action automatically. Park assist performs both parallel and perpendicular parking, as well as manoeuvring out of parallel parking spaces. The steering is done by the vehicle – the driver only needs to accelerate and apply the brakes. Also aids parking by acoustically and visually indicating distances to obstacles with guiding lines. Measured by sensors and a rear reversing camera	•	•	£750.00	£900.00
		In combination with Comfort package	•	•	£541.67
8T2	Cruise control. Maintains any speed above 18mph, provided that the engine power output and engine braking effect permit it; operated via separate steering column stalk, set speed is displayed in the Driver's Information System (DIS). Also available as part of the Comfort package	•	•	£187.50	£225.00
8Q5	Adaptive headlights. Swivelling headlights for improved illumination of a winding road. Also available as part of the Xenon light package on SE models	-	•	£245.83	£295.00

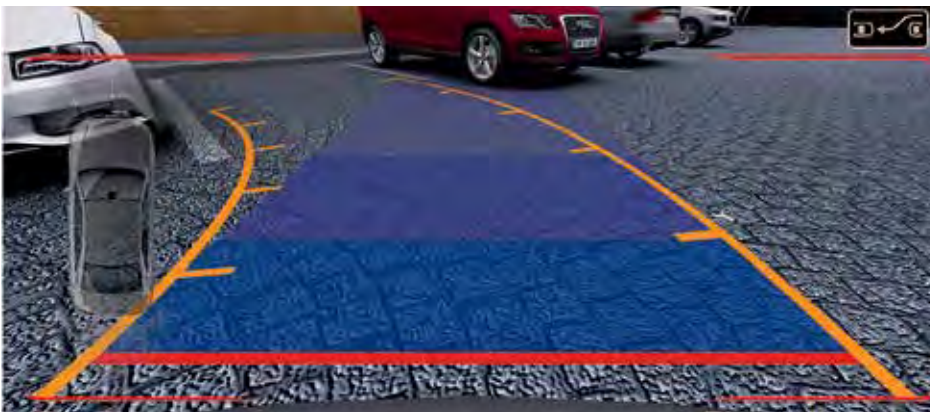

Audi parking system advanced with rear reversing camera



Audi parking system advanced with rear reversing camera and park assist

Safety and security

Order Code		SE	S line	Basic RRP	Total RRP inc VAT
8N7	High-beam assist. Automatically adjusts headlights from high-beam to dipped-beam when another vehicle is approaching. Only in combination with auto-dimming rear-view mirror (4L6) or Comfort package (WBI)	●	●	£83.33	£100.00
4X4	Rear side airbags. Situated in side of rear seats	●	●	£250.00	£300.00
UH2	Audi hill-hold assist. Once the vehicle comes to a stop, Audi hill-hold assist uses either the ESP system or the electromechanical parking brake to hold the vehicle stationary for an unlimited amount of time, thus preventing it from rolling away on uphill or downhill gradients	●	●	£75.00	£90.00
UG5	Hill descent control. Speed control by means of brake intervention and engine drag torque, whilst constantly maintaining speed depending on surface. The driver just has to steer, but does not have to accelerate or brake	●	●	£162.50	£195.00
7Y1	Audi side assist. Aids the driver when changing lane. Audi side assist monitors the area behind your car using radar sensors located discreetly in the rear bumper. It then informs the driver with a visual warning signal in the door mirror if there is a vehicle in their blind spot or approaching quickly from behind. The system is activated using a button in the driver's door	●	●	£375.00	£450.00
7Y4	Audi active lane assist. Lane markings are registered by an optical sensor in the windscreen from speeds of approximately 40mph or above. Camera identifies individual or coloured lane markings, e.g. yellow lines at roadworks. The lane departure warning system warns the driver if a detected lane marking is approached without indicating, and helps the driver to steer back towards the middle of the lane by making gentle steering movements. Steering wheel vibration can be activated as an additional warning when crossing lane markings. System is activated manually by a switch on the turn signal lever. Only available in combination with high beam assist (8N7) plus either auto-dimming rear-view mirror (4L6) or Comfort package (WBI). When ordered with Technology package, speed limit display is included as a no-cost option	●	●	£375.00	£450.00
QR9	Speed limit display. Camera-based detection and display of speed limits, including temporary speed limit displays. Speed limit signs are recognised by the camera and this enables the current speed limit to be read conveniently in the Driver's Information System (DIS). Should the camera not detect a sign, the speed limit from the navigation system data (if fitted) will be shown. Only available as a no-cost option when Technology package and Audi active lane assist are ordered together	●	●	No charge	No charge

Options are subject to availability and may extend delivery.

- = Not available
● = Available
S = Standard

RRP - Recommended Retail Price.

VAT is calculated at 20% but this may alter to reflect any change in the applicable VAT rate.

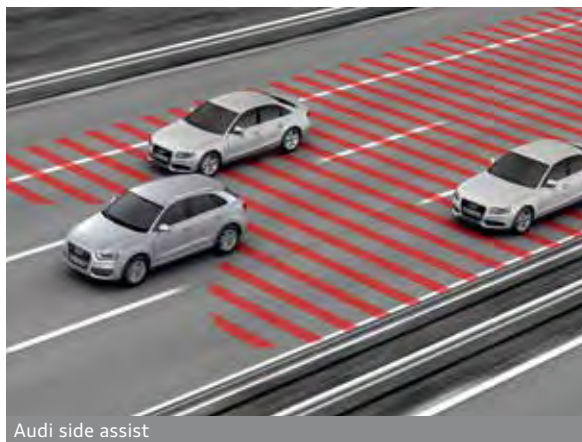

Audi side assist

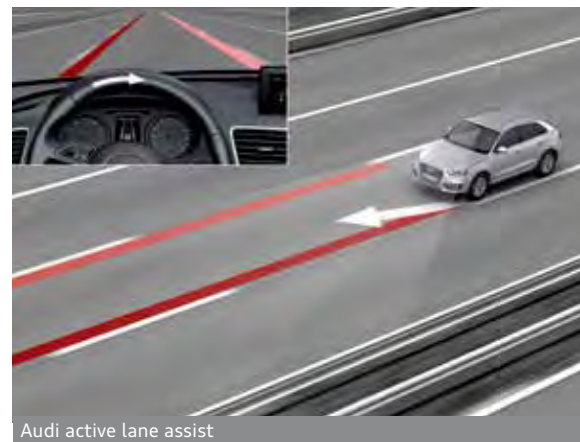

Audi active lane assist



Speed limit display

Steering wheels

You can choose from a selection of advanced leather multi-function steering wheels, allowing you to control various functions of your Audi Q3 at the touch of a button.

Order Code		SE	S line	Basic RRP	Total RRP inc VAT
1XW	3-spoke multi-function Q-design steering wheel with chrome finish on centre spoke. Manual models only	●	—	£100.00	£120.00
1XX	3-spoke multi-function Q-design steering wheel with gear-shift paddles and chrome finish on centre spoke. S tronic models only	●	—	£200.00	£240.00
YRH S3G	Audi exclusive leather-covered steering wheel rim*	●	●	£304.17	£365.00
YRB S3G	Audi exclusive controls package. Includes leather-covered steering wheel rim and gear-shift gaiter*	●	●	£708.33	£850.00

Options are subject to availability and may extend delivery.

- = Not available
- = Available
- S = Standard

RRP – Recommended Retail Price.

*Leather and stitching (where applicable) can be selected from any of the exclusive colours shown on page 44.

VAT is calculated at 20% but this may alter to reflect any change in the applicable VAT rate.



3-spoke multi-function Q-design steering wheel with gear-shift paddles and chrome finish on centre spoke

Looking after your Audi

When you've chosen your ideal model, it's reassuring to know that it will remain in safe hands. That's why we've created products to protect your Audi: from extended warranties to Audi Complete – our comprehensive service and maintenance package. And there's also a range of Audi accessories and merchandise to choose from, enabling you to further enhance and safeguard your car.





Audi Complete

Audi Complete is simply a way to look after the servicing and maintenance costs for your Audi in a single package. You pay a one-off or monthly fee and we'll cover all your servicing, maintenance and tyres for the next three years, including your first MOT. It means you only have to pay for fuel, insurance and your Road Fund Licence. So you can be reassured that your car will be maintained by trained Audi Technicians, using genuine Audi parts. You can also opt for our Service only or Service and Maintenance packages if you prefer.

*Retail customers only. Pricing based on 3 years/30,000 miles (whichever occurs sooner). All pricing is a 'starting from' price for the Audi Q3 model range and is therefore subject to change and mileage/model dependent.

Warranty

Options are subject to availability and may extend delivery.

- = Not available
• = Available
S = Standard

**Only available before registration of your Audi Q3. Please speak to your Audi Centre for full details.

RRP - Recommended Retail Price.

VAT is calculated at 20% but this may alter to reflect any change in the applicable VAT rate.

Order Code		Q3	Basic RRP	Total RRP inc VAT
-	Audi Complete - Service only. Comprehensive care for your Audi covering all your servicing for 3 years. Visit your local Audi Centre for further information or audi.co.uk/audicomplete for full details including terms and conditions	●	£13.33	£16.00*
-	Audi Complete - Service and Maintenance. Comprehensive care for your Audi covering all your servicing and maintenance for 3 years, as well as your first MOT. Visit your local Audi Centre for further information or go to audi.co.uk/audicomplete for full details including terms and conditions	●	£16.67	£20.00*
-	Audi Complete - Service, Maintenance and Tyres. Comprehensive care for your Audi covering all your servicing, maintenance and tyres for 3 years, as well as your first MOT. Visit your local Audi Centre for further information or go to audi.co.uk/audicomplete for full details including terms and conditions	●	£29.17	£35.00*

Order Code		Q3	Basic RRP	Total RRP inc VAT
-	Audi Warranty - covers you for unlimited mileage in the first 2 years of ownership, and up to 60,000 miles in the third year. Transferable between owners**	S	No charge	No charge
EA6	Audi Warranty - covers you for up to 4 years or 75,000 miles, whichever comes sooner. Cover includes a 2-year unlimited mileage warranty, and up to 75,000 miles in the third and fourth years. Transferable between owners**	●	£270.83	£325.00
EA9	Audi Warranty - covers you for up to 5 years or 90,000 miles, whichever comes sooner. Cover includes a 2-year unlimited mileage warranty, and up to 90,000 miles in the third, fourth and fifth years. Transferable between owners**	●	£620.83	£745.00

Accessories

Choosing an Audi isn't just a matter of deciding on the model you want – it's about creating a car that perfectly suits your needs. That's why we've developed a whole range of accessories to enhance your Audi Q3, enabling you to customise it down to the last detail. Like your Audi, all these accessories are developed to the highest possible standards. They're all available exclusively from Audi.

To find out more, just visit audi.co.uk/accessories or contact your local Audi Centre.

Warranty

All the accessories available on the Audi Q3 are covered by a three-year warranty* if they are ordered and included in the purchase price of the car at date of delivery. Any accessories ordered and installed after delivery include a two-year warranty.*

*Excluding Road Angel products. Audi Accessories warranty terms and conditions can be found at audi.co.uk



Merchandise

From the enthusiasts' motorsport collection to the sophisticated Audi collection, there's a wide variety of adults' and children's clothing, lifestyle accessories and collectables, all of which bear the Audi name.

Please speak to a member of our team at your local Audi Centre to see the full Audi collection and to place an order. A selection of Audi merchandise is also available to buy from audi.co.uk/merchandise.



Audi Difference

The experts in Vorsprung durch Technik

Our Audi Approved Master Technicians have undergone an impressive 100,000 hours of training over a 10-year programme to ensure they have the latest technical expertise for maintaining and servicing your Audi. All our Service Advisors undergo a specialist induction and training to ensure they are Audi professionals and able to talk to you about any issues you may have with your Audi vehicle.

Servicing tailored to your needs

Regular servicing is key to safeguarding your Audi's performance and a full Audi service history could help you enhance the future re-sale value. To make servicing easy, the Audi Service Schedules have been designed to work with your individual driving style and vehicle.

We offer two different schedules: the fixed Inspection Service and the variable LongLife Service schedule. The conventional fixed Inspection Service schedule has fixed intervals for the Oil-change Service and Inspection Service, which are determined by time and distance.

With the variable LongLife Service schedule, the Inspection Service intervals are also fixed but the Oil-change Service intervals are variable. Sensors take account of driving style and conditions to determine when the Oil-change Service is required and the driver is informed via the on-board service interval display.

The choice of Service Schedule will depend on journey type and mileage as well as individual driving style and conditions. The table to the right can be used for guidance but your Audi Centre will help you to determine the most suitable Service schedule for you based on your individual circumstances and preferences.

Fixed Inspection Service Schedule

	Vehicle usage:
Mileage	Less than 10,000 miles per annum. Mainly city/town centre driving. Short journeys.
	Service Intervals:
Oil-change Service	Fixed to every 9,000+ miles/1 year
Inspection Service	Fixed to every 19,000+ miles/2 years

Variable LongLife Service Schedule

	Vehicle usage:
Mileage	More than 10,000 miles per annum. Motorway and main road driving. Mainly longer distance journeys. Constant speeds.
	Service Intervals:
Oil-change Service	Variable to a maximum of every 19,000+ miles/2 years
Inspection Service	Fixed to every 19,000+ miles/2 years

When a vehicle is frequently used in the following conditions, we recommend the vehicle is on a Fixed Inspection Service Schedule, regardless of mileage:

Uneconomical driving styles, e.g. heavy acceleration and braking and constant use of high revs
High engine-loading conditions, e.g. frequent towing and hill climbs

*As indicated by the service interval display. Mileages are approximate as the Service Indicator system uses kilometres as its distance measurement.

Your convenience comes first

At Audi you can choose from a range of convenient services that suit your needs. Why not book a 'service while you wait' appointment* and enjoy our complimentary refreshments while your car is with us? Or, if you need to be mobile, take advantage of one of our courtesy cars which we can even collect and deliver to you.* We guarantee we can service your Audi within 5 days without a courtesy car or within 10 days if you need transport. We will also ensure your car is returned to you with a full valet.

Audi Genuine Parts

You can rest assured that only Audi Genuine Parts will be used on your vehicle. What's more, Audi parts and labour come with a 2-year guarantee.**

No hidden costs

We believe strongly in transparency when it comes to our prices. For added peace of mind, we will give you a quotation over the phone for the work you have requested and email you the price confirmation. We'll consult you if any additional work on your car is needed when it is with us. We won't carry out any extra work without asking your permission first.

All part of the service

Whenever we see an Audi for a service, we connect it directly to our headquarters in Ingolstadt which enables us to check your car's software and make sure it's as up-to-date as possible. If the factory has released a software upgrade for your model, it can be applied immediately - improving anything from your car's efficiency to the precision of its parking system.

Audi Roadside Assistance

Your new car comes complete with 3 years' complimentary roadside assistance and recovery across the UK, provided by RAC Motoring Services. Also included is roadside assistance throughout Europe, managed by RAC Motoring Services.

For further information and terms and conditions please visit audi.co.uk

*Subject to availability.

**Excludes wear and tear.



Audi Q3 technical data

Engine	Petrol			Diesel					
	2.0 TFSI quattro	2.0 TFSI quattro	2.0 TFSI quattro	2.0 TDI	2.0 TDI quattro	2.0 TDI quattro	2.0 TDI	2.0 TDI quattro	2.0 TDI quattro
Transmission	6-speed manual	7-speed S tronic	7-speed S tronic	6-speed manual	6-speed manual	7-speed S tronic	6-speed manual	6-speed manual	7-speed S tronic
Cylinder	4-cylinder	4-cylinder	4-cylinder	4-cylinder	4-cylinder	4-cylinder	4-cylinder	4-cylinder	4-cylinder
Displacement, cubic cm (valves per cylinder)	1984	1984	1984	1968	1968	1968	1968	1968	1968
Max. power ¹ , PS at rpm	170/4300-6200	170/4300-6200	211/5000-6200	140/4200	140/4200	140/4200	177/4200	177/4200	177/4200
Max. torque, Nm at rpm	280/1700-4200	280/1700-4200	300/1800-4900	320/1750-2500	320/1750-2500	320/1750-2500	380/1750-2500	380/1750-2500	380/1750-2500
Top speed, mph	132	132	143	126	122	123	135	134	132
0-62mph acceleration, seconds	8.2	7.8	6.9	9.9	9.9	9.9	8.3	8.1	8.2
CO ₂ emissions ² , g/km	174	179	179	137	149	152	144	148	156
Benefit in kind (BIK), %	26%	27%	27%	22%	24%	25%	23%	24%	26%
Fuel consumption ² , mpg (l/100km) Urban	29.7 (9.5)	27.7 (10.2)	27.7 (10.2)	45.6 (6.2)	40.9 (6.9)	41.5 (6.8)	44.1 (6.4)	43.5 (6.5)	40.4 (7.0)
Fuel consumption ² , mpg (l/100km) Extra Urban	46.3 (6.1)	44.1 (6.4)	44.1 (6.4)	60.1 (4.7)	56.5 (5.0)	54.3 (5.2)	56.5 (5.0)	54.3 (5.2)	53.3 (5.3)
Fuel consumption ² , mpg (l/100km) Combined	38.7 (7.3)	36.7 (7.7)	36.7 (7.7)	54.3 (5.2)	49.6 (5.7)	48.7 (5.8)	51.4 (5.5)	50.4 (5.6)	47.9 (5.9)
ABI insurance group 1-50 ³	20E	20E	25E	18E	18E	TBC	TBC	TBC	21E
Unladen weight ³ , kg	1510	1555	1565	1445	1535	1570	1490	1575	1585
Gross weight limit, kg	2110	2155	2165	2045	2135	2170	2090	2175	2185
Roof load limit/nose weight, kg	75/80	75/80	75/80	75/80	75/80	75/80	75/80	75/80	75/80
Max trailer load ⁴ unbraked, kg	750	750	750	750	750	750	750	750	750
Max trailer load ⁴ with 12% gradient, kg	1800	2000	2000	1800	1800	2000	2000	2000	2000
Max trailer load ⁴ with 8% gradient, kg	1800	2000	2000	1800	1800	2000	2000	2000	2000
Luggage compartment capacity, rear seats upright, litres	420	420	420	420	420	420	420	420	420
Luggage compartment capacity, rear seats folded, litres	1325	1325	1325	1325	1325	1325	1325	1325	1325
Fuel tank capacity approx, litres	64	64	64	64	64	64	64	64	64
Emission standard	EU5	EU5	EU5	EU5	EU5	EU5	EU5	EU5	EU5

*Highest insurance group rating shown. Group may be lower dependent on trim level. Please visit www.thatcham.org/abigroupratings for details.

¹The given value was obtained in accordance with the specified measurement procedure (the respective current version of the Directive 80/1269/EEC).

²Fuel consumption and CO₂ emissions figures are obtained under standardised test conditions (Directive 93/116/EEC) using a representative model. This allows direct comparison between different models from different manufacturers, but may not represent the actual fuel consumption achieved in 'real world' driving conditions. More information is available at www.vca.gov.uk.

³Vehicle's unladen weight without driver (calculated in accordance with the current version of Directive 80/1268/EEC). The fitting of additional equipment may increase the vehicle's unladen weight and drag coefficient, whereupon the potential carrying capacity and top speed will be correspondingly reduced.

⁴The engine's power output always goes down with increasing altitude. At 1,000m above sea level, and for every additional 1,000m, deduct 10% from the weight of the outfit (trailer load limit + gross weight of the towing vehicle).

Audi Q3 dimensions

The technical drawings opposite show the exact dimensions of the Audi Q3, so you can check everything – from whether the car will fit in your garage to whether your luggage will fit in the boot.

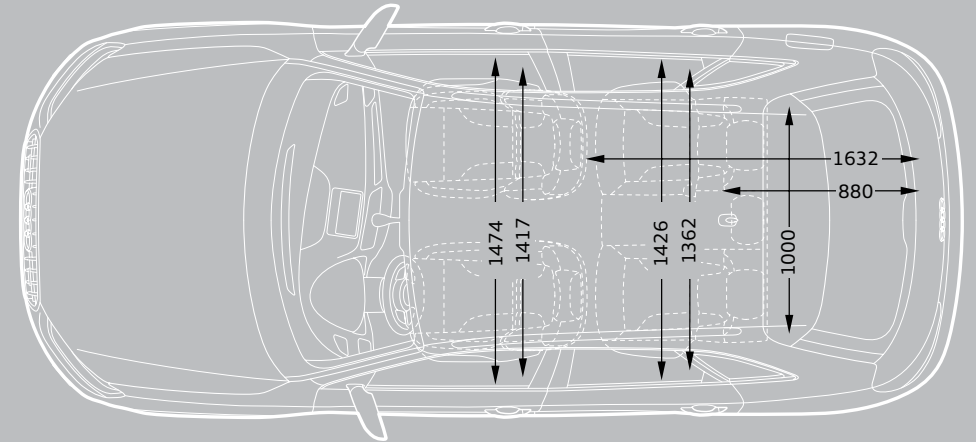
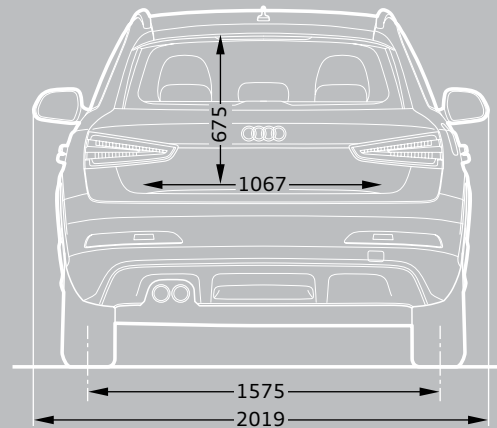
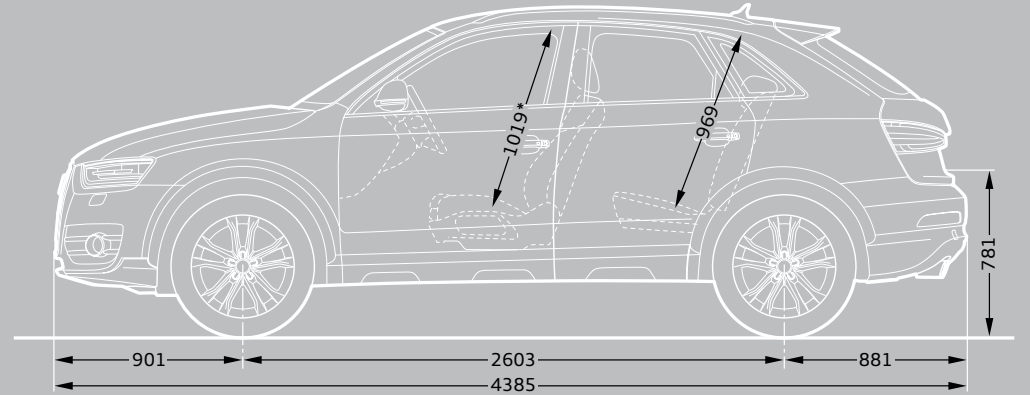
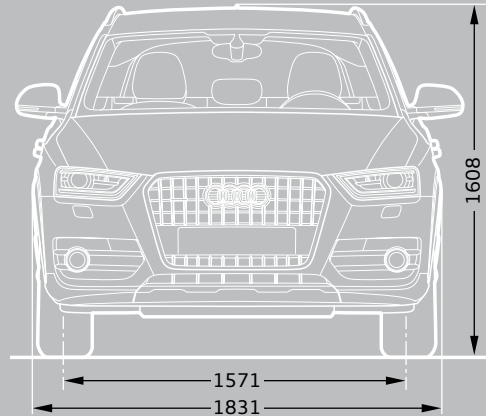

*Maximum headroom

Dimensions measured with vehicle at unladen weight.

Turning circle approx 11.8m.

Dimensions in millimetres.

Pricing and Additional information

Welcome to Audi

By placing an order for your Audi, you're choosing to get behind the wheel of one of the most sophisticated cars on the road. And because we believe the service we offer should be just as advanced, we want to let you know exactly what you can expect from us, now and in the future.

We've agreed a set of standards with all our Centres which governs the way we do business with you. It outlines the kind of service we promise to deliver for every customer, right down to filling each new Audi we sell with half a tank of fuel.

So whether you're interested in the date your car will arrive in the UK or the way we'll dispose of non-biodegradable materials after we service your Audi, you can have total confidence in us.

Audi Promise

Audi Centres

We guarantee that all our Centres will be open as follows:

Sales: Monday to Friday 9am–6pm
Saturday 9am–5pm

Service: Monday to Friday 8am–6pm
Saturday 8.30am–1pm

Sunday opening is at local discretion.

New car delivery

Once we've confirmed a delivery date for your car, we'll keep you informed of progress. Subject to reasonable notice, we'll then deliver it to a place of your choice, whether that's your home or work. In the unlikely event of a delay, we'll provide a courtesy car to minimise inconvenience and keep you mobile.

Environmental commitment

We promise to dispose of all non-biodegradable materials from your vehicle in a responsible manner.

Pricing

Prices and specifications given are correct at the time of printing. Always check details with your Audi Centre as Audi policies are continually developing. We reserve the right to change prices or specifications at any time.

All prices are subject to VAT, currently charged at 20%, but this may alter to reflect any change in the applicable VAT rate.

Delivery charges and number plates are not included in the vehicle price.

Delivery charge	£471.66
Number plate	£20.00
VAT	£98.34
Total	£590.00

Audi Customer Care

Every new Audi benefits from the comprehensive Audi Customer Care Package, which comprises:

- ▶ A 3-year Audi warranty, which covers you for unlimited mileage in the first 2 years of ownership, with a full mechanical and electrical warranty which covers you for up to 60,000 miles in the 3rd year
- ▶ A 3-year paint warranty
- ▶ A 12-year anti-corrosion warranty
- ▶ 3 years' UK roadside assistance and recovery

You also have the option when ordering your new car of choosing a 4-year or 5-year Audi warranty. Speak to a member of the sales team for more information.

Audi tax-free sales

If you are entitled to purchase a vehicle free of VAT, normally through military or diplomatic privilege, please contact your local Audi Centre for full details.

Should you have any difficulty obtaining the information you require, please call Freephone 0800 585878.

Audi Finance

Audi Finance specialises in providing funding solutions for Audi drivers. Whether your Audi is for private or business use, there is a range of funding options to choose from.

Below is the full range of finance products, which comprises:

- ▶ Solutions – a Personal Contract Plan
- ▶ Hire purchase
- ▶ Lease purchase
- ▶ Finance lease
- ▶ Contract hire

With all products, you can choose a fixed-cost maintenance plan designed to help you budget accurately.

No matter which Audi model you choose, your local Audi Centre can provide you with a personalised quote designed to fit your budget and motoring needs.

Audi Finance is a trading name of Volkswagen Financial Services (UK) Limited. An offer of finance depends on certain conditions. Available to people over 18 in the UK only.

Audi Insurance

We want you to start enjoying your new car from day one and thanks to Audi Insurance complimentary 7-day cover, you can. Call free on 0800 316 7893 (lines are open Monday to Friday 8am–9pm, and Saturday 9am–5pm), provide a few details and a cover note will be sent to your Audi Centre. They will then tax your car and you can drive it away.

Additional information

CO₂ data and information

CO₂ emissions-based Vehicle Excise Duty

Vehicle Excise Duty (Road Fund Licence) is based upon the amount of Carbon Dioxide (CO₂) a vehicle emits, measured in grams per kilometre (g/km). First year VED rates apply to the first year of ownership. Annual VED rates apply thereafter. The DVLA has created thirteen categories:

Petrol and Diesel engines	First year	Annual rate (second year onwards)
A – up to 100g/km	£0.00	£0.00
B – 101 to 110g/km	£0.00	£20.00
C – 111 to 120g/km	£0.00	£30.00
D – 121 to 130g/km	£0.00	£105.00
E – 131 to 140g/km	£125.00	£125.00
F – 141 to 150g/km	£140.00	£140.00
G – 151 to 165g/km	£175.00	£175.00
H – 166 to 175g/km	£285.00	£200.00
I – 176 to 185g/km	£335.00	£220.00
J – 186 to 200g/km	£475.00	£260.00
K – 201 to 225g/km	£620.00	£280.00
L – 226 to 255g/km	£840.00	£475.00
M – over 255g/km	£1,065.00	£490.00

Vehicle Excise Duty (VED) rates correct at time of going to print, but these may alter to reflect any change in the applicable VED rate.







Audi UK

Customer Services
Selectapost 29
Sheffield
S97 3FG
0800 699888
audi.co.uk

Specifications and prices subject
to change without notice.

© Audi UK

Printed in the UK
Edition 3.1 06/13
2014 model year

Images are for illustrative purposes only.

