



The Audi Q5 and new SQ5

Pricing and Specification Guide
Valid from May 2013

Personalising your Audi Q5

This guide has been designed to help you tailor and price your Audi Q5 quickly and logically. At the back, you will find information on CO2 emissions-based taxation and the other services offered by Audi, including Finance and Insurance. You can also configure your Audi Q5 online at audi.co.uk.

Audi Vision

To accompany this printed guide, we've created Audi Vision – an intuitive app that lets you find out even more about the Audi Q5. Compatible with Apple and Android phones and tablets, Audi Vision gives you exclusive access to images, information and video content – all of which is designed to help you explore and understand the options available with this model.

You'll see the Audi Vision logo printed next to the page number on pages throughout this guide and wherever you do, you'll be able to view additional content on that page.



The Audi Q5

Engines	12
Transmissions	13
Efficiency	14
quattro®	16

Model details and prices

SE model equipment	20
S line model equipment	22
S line Plus model equipment	24
SQ5 model equipment	26
Model prices	28

Audi exclusive

Colour and upholstery

Paint	34
Upholstery	38
Colour and trim guide	46

Inlays

Options

Wheels, tyres and suspension	56
Packages	62
Audio and communication	64
Interior equipment	66
Exterior equipment	70
Safety and security	71
Steering wheels	73

Looking after your Audi

Audi Complete and warranty	74
Accessories	77
Merchandise	78
Audi Difference	79

Technical details

Off-road capabilities	80
Technical data	82
Dimensions	84
Pricing and Additional information	86





Vorsprung durch Technik

Three words that express the very essence of Audi. Vorsprung durch Technik isn't a slogan. It's our way of seeing the world. It is the driving force behind our history of innovation that continues into the 21st century. Indeed, many technologies that Audi pioneered remain in our cars today. Some are milestones in the history of the motorcar.

From our beginnings in 1899, to the Auto Union team's Grand Prix successes in the 1930s and our more recent wins at Le Mans, we have always been at the forefront of the motor industry.

Vorsprung durch Technik makes us who we are. To see more of its influence, just read on.





The streamlined Audi Q5

The Audi Q5 isn't a typical SUV; it combines the poise and athleticism of a coupé with the practicality and space of a much larger car. It also offers the exceptional grip of quattro® all-wheel-drive, 18-inch alloy wheels and some other advanced features you might not expect. There's a choice of direct-injection TDI® and TFSI® engines, a five-link front suspension and optional S tronic® or tiptronic® transmission – ensuring that the Audi Q5 delivers all the handling and performance its coupé-like shape suggests.









Q5 interior story

We've introduced a number of finishing touches to the Audi Q5 interior to make your driving experience both comfortable and unique. You'll find an impressive attention to detail in everything from the luxurious leather seating to our optional customised stitching, which means that every journey you make will be a personal one.

Engines

Petrol

TFSI® direct-injection technology is a unique Audi innovation that includes supercharging, which combines FSI® technology with forced induction – giving cars an extra injection of power and torque. It also delivers enhanced fuel efficiency as precisely the right amount of fuel and air are injected into the combustion chambers, enabling the engine to ‘breathe’ more easily. It results in reduced heat loss and increased output, with around a 15% reduction in fuel consumption and significantly lower exhaust emissions.

Diesel

We introduced TDI® to the roads in 1989, and since then, we’ve continuously refined it, including developing common-rail technology. With this system, a series of piezo injectors use electrical charge to precisely control the amount of fuel injected into the engine. As well as reducing noise, this allows combustion to happen at a lower temperature, with less oxygen, which lowers emissions. The recently introduced bi-turbo diesel engine in the new SQ5 is our most powerful six-cylinder diesel engine to date, capable of 313PS and an impressive combined mpg of 41.5.





Transmissions

S tronic®

Driving is all about thinking ahead, which is just what the S tronic® dual-clutch transmission does. It works almost as two separate systems, one engaging the odd-numbered and the other the even-numbered gears. So when you're accelerating in second, it has third gear waiting for you. And once you make the switch, it's already thinking about fourth. With two clutches working together, you can change gears almost instantly while experiencing smooth, uninterrupted power.

tiptronic®

The 8-speed tiptronic transmission system reduces both fuel consumption and CO₂ emissions. It converts high-torque engine power into sporty performance and operating convenience, with crisp, fast gear changes and an optimised gear-shift strategy. More spontaneous gear changes are a particular benefit, especially when downshifting. Both in the 'D' (Drive) and 'S' (Sport) programme, the advanced electronics used in tiptronic® respond efficiently to every driver input.

Efficiency

At Audi, doing less is something we're trying to do more of. We're working to use less fuel, release less CO₂ and waste less energy. It's why we've incorporated a number of more efficient technologies into the Audi Q5.

Recuperation

When a vehicle brakes, the discs convert the kinetic energy into thermal energy, which is wasted as it cannot be used. With a recuperation system like the one in the Audi Q5, the kinetic energy is converted into useful electrical energy. The way it works is simple. While the car is coasting or braking, the alternator voltage is raised above the level of the basic electrical system, which enables the alternator to generate electrical energy and store it temporarily in the battery. When the vehicle accelerates, this energy is used to relieve the load on the alternator, resulting in a fuel saving of up to 3%.





Aerodynamics

A car's shape can have a big impact on its efficiency. It's why we've worked to make the Audi Q5 as aerodynamic as possible.

Automatic Start-Stop function

In heavy traffic, your car still uses fuel and releases CO₂, even when it's stationary. The automatic Start-Stop function counteracts this problem by switching off the engine when your car comes to a standstill. As soon as you touch the clutch, the car restarts. In conjunction with TDI® and TFSI® engines, it helps save up to 0.4 litres of fuel every 100km.

quattro®

It's the technology that gave us the edge on the rally circuit ever since it was first introduced over 30 years ago, bringing victory for the Audi quattro on its very first outing. It's called quattro® permanent all-wheel-drive. In this system, four permanently driven wheels deliver better acceleration, road-holding and safety, while asymmetric dynamic torque distribution intelligently controls the flow of power to the front and rear axles.

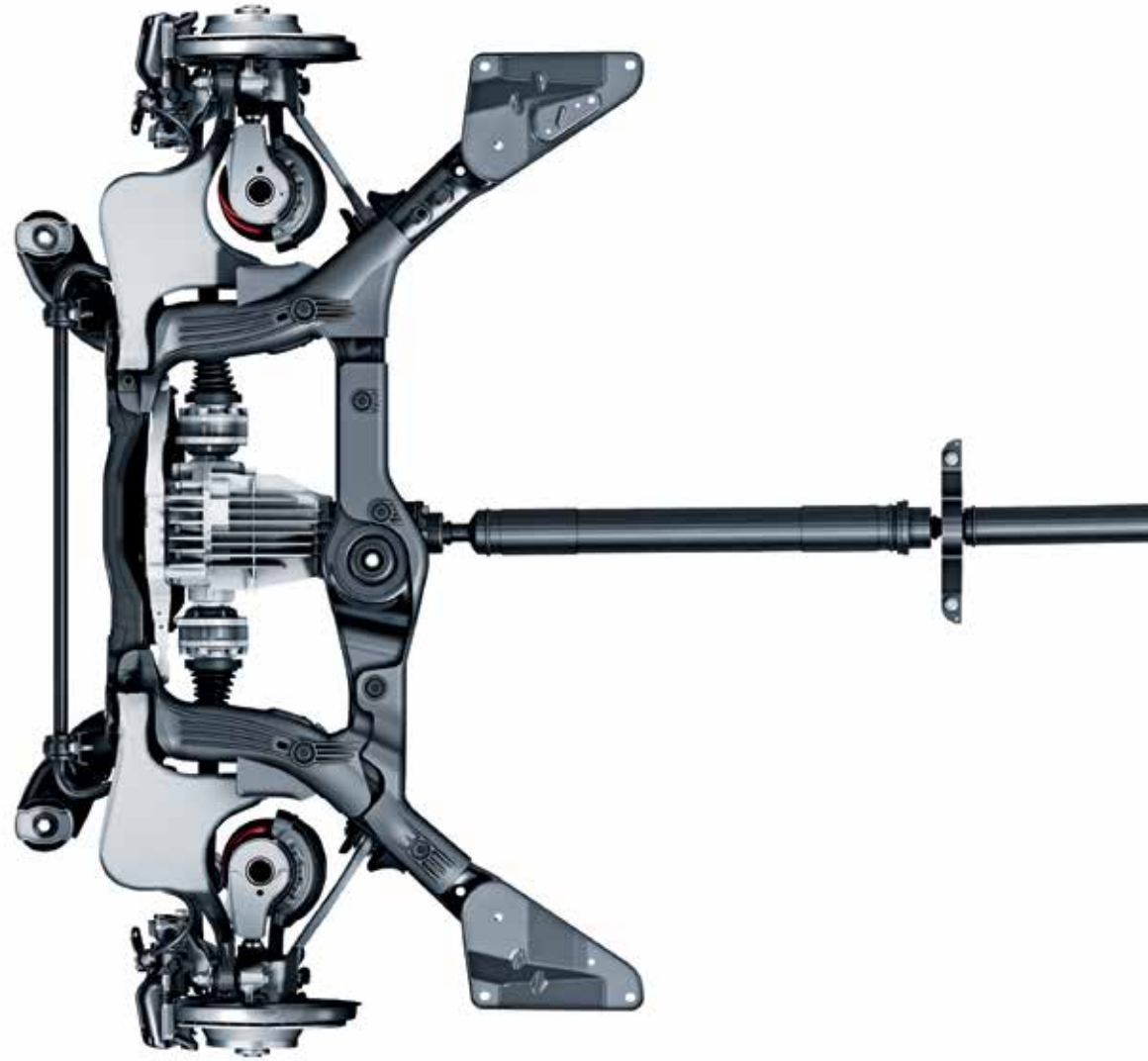

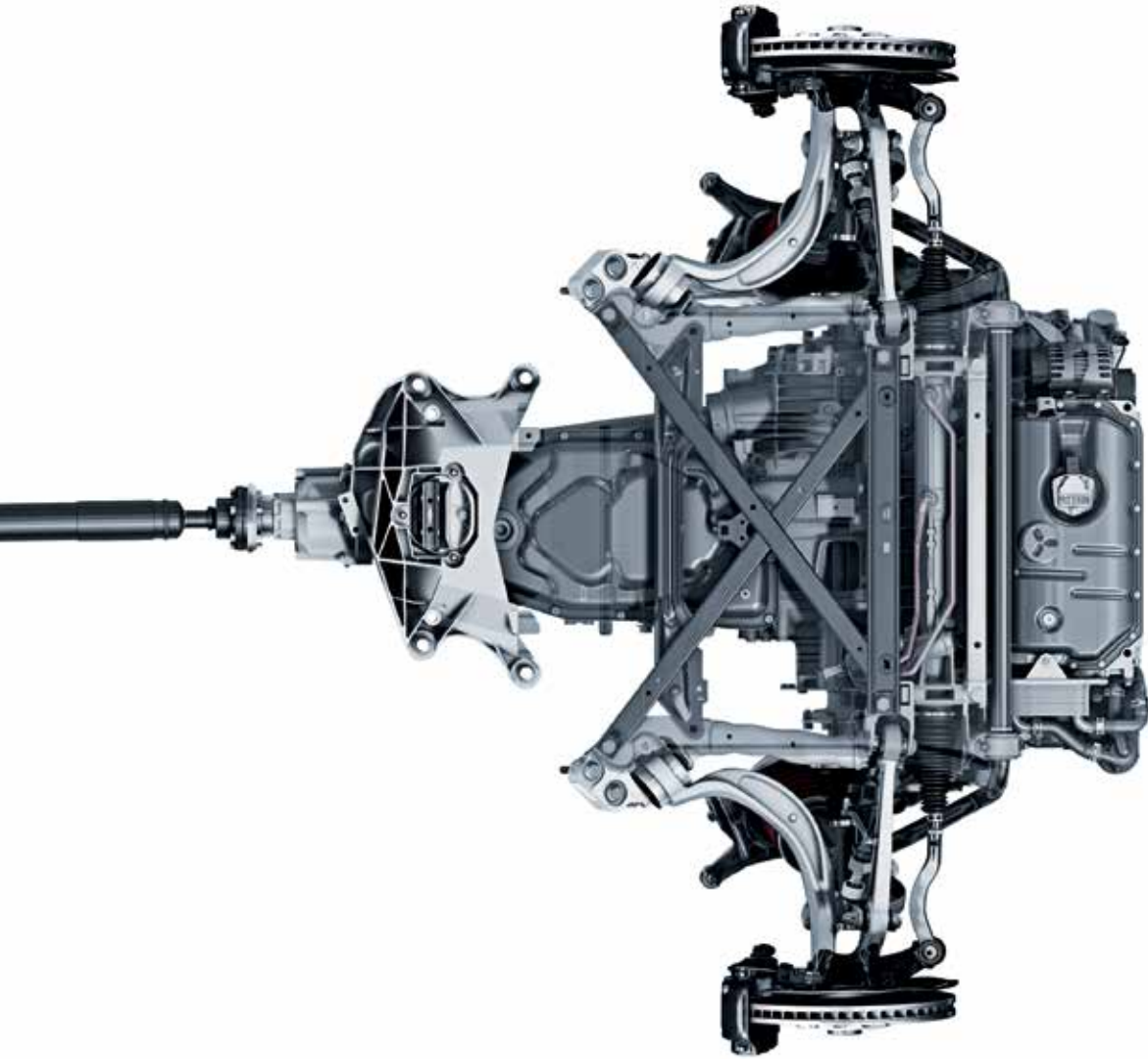

It means that the Audi Q5 can 'read' the road, sensing changes in the surface beneath the wheels and adjusting their grip accordingly. So when conditions get a little more demanding – in particular, when you go off-road – quattro® adapts, putting all the force of the Audi Q5's engine precisely where it's needed to handle the change in terrain.





SE model equipment

All Audi Q5 models have the following items of standard equipment

Engine

Automatic Start-Stop function for greater fuel and CO₂ efficiency

Recuperation for optimal energy utilisation

Misfuelling inhibition for diesel models

Wheels, tyres and suspension

18" x 8J '10-spoke V' design alloy wheels with 235/60 R18 tyres and locking wheel bolts

Electromechanical Power Steering

Collapsible spare wheel

Audio and communication

Audi Concert radio which includes:

- Single CD drive and SDHC memory card reader which are MP3, WMA and AAC compatible
- 6.5" colour centre display with MMI operating logic
- AUX-IN connection
- TP memo - automatically saves traffic news when driving

Audi sound system - 10 high-performance loudspeakers (180 watts) and 6-channel amplifier

DAB digital radio reception - integrated into MMI, receives digitally-transmitted radio stations in addition to the range of analogue stations. Displays music track, artist and radio program. Capable of 'DAB slideshow' where transmitted. Reception dependent on local digital network. Automatic switch from DAB to FM reception if the network signal is not strong enough

Mobile Phone preparation - Bluetooth Interface

Interior equipment

4-spoke multi-function leather steering wheel (with gear-shift paddles for automatic models)

Aluminium Satellite inlays

Cruise control - maintains any speed above 18mph, provided the engine power output and engine braking effect permit it; operated via separate steering column stalk. The set speed is displayed in the Driver's Information System

Driver's Information System (DIS) in colour with energy-saving tips and rest recommendations. Shows the radio station or track title, telephone control, menu and other display information from the infotainment system such as navigation (if fitted). Also includes an on-board trip computer with short and long-term memory, outside temperature display, digital speedometer and door or boot open warning

Deluxe 3-zone climate control with separate air distribution and digital display for the driver and front passenger. System includes air-conditioning controls in rear centre console for passenger compartment

Front and rear electric windows

Front and rear floor mats

Front centre armrest including 12-Volt socket



4-spoke multi-function leather steering wheel



Deluxe 3-zone climate control



Door mirrors - electrically adjustable and heated



Halogen headlights with daytime-running lights

Safety and security

Auto-dimming rear-view mirror including acoustic windscreen

Anti-theft device – Thatcham category 1 approved

Rest recommendation system – analyses driving behaviour based on steering, pedals and gear lever movements. If the system detects a change in driving patterns it can, via audio and visual effects, notify the driver of the possible need to take a rest

Light and rain sensor – automatically switches the dipped beam headlights and windscreen wipers on/off depending on the light and rain conditions. Also includes coming home/leaving home function which delays the deactivation of the front and rear lights after locking and automatic activation of the lights when unlocking

Electromechanical parking brake includes parking brake function when stationary, drive-off assistance function through automatic release when driving away and emergency braking function whilst driving, acting on all 4 wheels

First-aid kit

Front and rear fog lights

Front and rear ISOFIX seats with airbag de-activation switch for front passenger seat

Halogen headlights with daytime-running lights

Hill descent assist (please see page 80 for further information) with off-road Electronic Stability Programme (ESP)

Front side airbags

Rear parking sensors – facilitates parking by acoustically indicating the distance to obstacles; measurement is by ultrasonic sensors integrated discreetly into the bumper

Tool kit and car jack

Warning triangle

Seats

3-point seat belt with belt-force limiters for all 5 seats

Milano leather upholstery

Split-folding rear seat

Exterior equipment

Aluminium roof rails with roof bar detection (automatically adjusts the ESP to react to the higher centre of gravity when roof bars are in place)

Aluminium window trims framing the exterior side windows

Chrome trimmed, flat-bottom design exhaust pipe – 2.0 TDI engines have single exhaust pipe on left-hand side, 2.0 TFSI, 3.0 TFSI and 3.0 TDI have one exhaust pipe on either side

Door mirrors – electrically adjustable and heated

Full body-coloured bumpers

Highly polished black grille with vertical chrome struts

Rear spoiler

Roof bars and storage bag



Image shows the Q5 SE model with optional Ice silver, metallic paint (P5) and Adaptive Xenon headlights (PX1, 8Q5)

S line model equipment

In addition to SE model equipment

Basic RRP
£2,000.00

Total RRP inc VAT
£2,400.00

Wheels, tyres and suspension

19" x 8J '5-spoke' design alloy wheels with 235/55 R19 tyres and locking wheel bolts

Standard suspension (S line Sports suspension available as a no-charge option)

Seats

Front Sports seats in Fine Nappa leather with electric lumbar support (S line embossed)

Interior equipment

Black headlining

Matt-brushed aluminium inlays

S line 3-spoke leather multi-function steering wheel (with gear-shift paddles for automatic models)

S line sill plates and aluminium loading strip for the boot

Exterior equipment

Diffuser in Platinum grey

Rear LED lights

S line exterior styling package including:

- S line badges on front wings
- S line front bumper
- S line rear diffuser
- S line side skirts
- S line grille with chrome vertical bars

Xenon headlights with automatic headlight-range adjustment, headlight washers and LED daytime-running lights



19" x 8J '5-spoke' design alloy wheels



Xenon headlights



Matt-brushed aluminium inlays



Rear LED lights



Image shows the Q5 S line model with optional Daytona grey, pearl effect paint (6Y) and 20" '7-double-spoke' design alloy wheels (PQF)

S line Plus model equipment

In addition to S line model equipment

Basic RRP
£2,083.33

Total RRP inc VAT
£2,500.00*

*Valid for new vehicle orders placed up to and including 30 September 2013. Subject to availability.

Wheels, tyres and suspension
20" x 8.5J '5-segment-spoke' design alloy wheels with 255/45 R20 tyres

Audio and communication
Audi Music Interface – Universal connection for use with stereo audio sources and Apple iPod generation 4 onwards. Provides storage and charging

Interior equipment
MMI Navigation system plus. Hard disk navigation with topographical map display, places of interest and town models in 3D, with high-resolution 7" colour TFT display. The system offers three alternative routes, with the ability to scroll along the selected route and manoeuvre within the map. Uses 7-digit postcode recognition. Includes split-screen mode for route information, dynamic route guidance (TMC), intersection zoom function, motorway exits and lane recommendations in Driver's Information System (DIS). When combined with Mobile telephone preparation – High with Audi connect (9ZW), the system uses Google Earth images for navigation. Includes 2 SD card readers, single CD/DVD player, 40GB hard drive and Jukebox (20GB) for storing and managing music files in WMA and MP3 format. Includes European navigation data (where digitised)

Exterior equipment
Audi parking system plus – Acoustic and visual park-assist system for the front and rear with MMI screen display; measurement is by ultrasonic sensors concealed in the bumpers
Electric tailgate
Metallic paint
Privacy glass



20" x 8.5J '5-segment-spoke' design alloy wheels



Audi Music Interface



MMI Navigation system plus



Image shows the Q5 S line Plus model with optional 20" '5-double-spoke off-road' design alloy wheels (PQ7)

SQ5 model equipment

in addition to SE model equipment

Wheels, tyres and suspension

20" x 8.5J '5-parallel-spoke' design alloy wheels with 255/45 R20 tyres. Includes small wheel arch extensions

'S' Sports suspension (30mm lower than SE suspension)

Interior equipment

LED interior light package

3-spoke 'S' Sports multi-function leather steering wheel with paddle shift and contrast stitching

Matt-brushed aluminium inlays

'S' instrument dials

Aluminium scuff plates with SQ5 logo

Seats

Electrically-adjustable front seats with SQ5 embossing. Includes adjustment for height, forwards and backwards position, backrest angle and lumbar support

Fine Nappa leather upholstery

Leather door armrests

Exterior equipment

Xenon headlights with automatic headlight-range adjustment, headlight washers and LED daytime-running lights

Rear LED lights

Aluminium-effect door mirror housings

'S' radiator grille with SQ5 logo finished in platinum grey

Front black painted brake callipers with 'S' logo

'S' body styling

Exhaust pipes – two oval tailpipes on left and right-hand side in chrome rolled finish

Active Sound exhaust system



SQ5 grille with horizontal double chrome struts



20" x 8.5J '5-parallel-spoke' design alloy wheels



Dual oval tailpipes



Image shows the SQ5 model with optional Estoril blue, crystal effect paint (K0) and 21" '5-twin-spoke Star' design alloy wheels in titanium look with a high gloss finish (PQ8)

Audi Q5 SE

Engines	Power	Transmissions	CO ₂ g/km	Basic RRP	Total RRP inc VAT	Recommended OTR
2.0 TFSI quattro	180PS	6-speed manual	174	£25,041.67	£30,050.00	£30,980.00
2.0 TFSI quattro	225PS	6-speed manual	174	£26,166.67	£31,400.00	£32,330.00
2.0 TFSI quattro	225PS	8-speed tiptronic	184	£27,458.33	£32,950.00	£33,930.00
2.0 TDI quattro	150PS	6-speed manual	154	£25,354.17	£30,425.00	£31,245.00
2.0 TDI quattro	177PS	6-speed manual	154	£26,166.67	£31,400.00	£32,220.00
2.0 TDI quattro	177PS	7-speed S tronic	159	£27,458.33	£32,950.00	£33,770.00
3.0 TDI quattro	245PS	7-speed S tronic	169	£30,875.00	£37,050.00	£37,980.00

Audi Q5 S line

Engines	Power	Transmissions	CO ₂ g/km	Basic RRP	Total RRP inc VAT	Recommended OTR
2.0 TFSI quattro	180PS	6-speed manual	174	£27,041.67	£32,450.00	£33,380.00
2.0 TFSI quattro	225PS	6-speed manual	174	£28,166.67	£33,800.00	£34,730.00
2.0 TFSI quattro	225PS	8-speed tiptronic	184	£29,458.33	£35,350.00	£36,330.00
2.0 TDI quattro	150PS	6-speed manual	154	£27,354.17	£32,825.00	£33,645.00
2.0 TDI quattro	177PS	6-speed manual	154	£28,166.67	£33,800.00	£34,620.00
2.0 TDI quattro	177PS	7-speed S tronic	159	£29,458.33	£35,350.00	£36,170.00
3.0 TDI quattro	245PS	7-speed S tronic	169	£32,875.00	£39,450.00	£40,380.00

Please note: The maximum power output figures are quoted in PS (or Pferdestärke, which is the metric equivalent of brake horsepower). To convert to brake horsepower, divide the PS figure by 1.0139.

Recommended On-The-Road (OTR) retail prices include: delivery charge, half a tank of fuel, number plates at £590.00 (inc. VAT), Road Fund Licence (which may vary depending on model/transmission – see page 87 for details) and first registration fee at £55.00. Vehicle Excise Duty correct at time of going to print, but this may alter to reflect any change in the applicable VED rate.

RRP – Recommended Retail Price. VAT is calculated at 20% but this may alter to reflect any change in the applicable VAT rate.

Audi Q5 S line Plus

Engines	Power	Transmissions	CO ₂ g/km	Basic RRP	Total RRP inc VAT	Recommended OTR
2.0 TFSI quattro	180PS	6-speed manual	174	£29,125.00	£34,950.00	£35,880.00
2.0 TFSI quattro	225PS	6-speed manual	174	£30,250.00	£36,300.00	£37,230.00
2.0 TFSI quattro	225PS	8-speed tiptronic	184	£31,541.67	£37,850.00	£38,830.00
2.0 TDI quattro	150PS	6-speed manual	154	£29,437.50	£35,325.00	£36,145.00
2.0 TDI quattro	177PS	6-speed manual	154	£30,250.00	£36,300.00	£37,120.00
2.0 TDI quattro	177PS	7-speed S tronic	159	£31,541.67	£37,850.00	£38,670.00
3.0 TDI quattro	245PS	7-speed S tronic	169	£34,958.33	£41,950.00	£42,880.00

Audi SQ5

Engines	Power	Transmissions	CO ₂ g/km	Basic RRP	Total RRP inc VAT	Recommended OTR
3.0 BiTDI quattro	313PS	8-speed tiptronic	179	£35,895.83	£43,075.00	£44,055.00





Audi exclusive

Every Audi is intrinsically exclusive. It's the breathtaking design, the exceptional engineering, the Vorsprung durch Technik. But for that special touch, you can specify your Audi Q5 with options from Audi exclusive. Whether you want a unique, custom-mixed paint colour or seats in a combination of complementary shades, Audi exclusive will enable you to drive the car you've always imagined.

Both the exclusive and standard options can be found on the following pages.





Audi exclusive line

There are a number of ways to customise your car's interior with the Audi exclusive range. And if you'd like us to help you choose, we've put the most popular elements of the range together into one harmonious package – the Audi exclusive line.

With experience spanning more than 20 years, our expert designers understand which elements work well together. From high-quality Fine Nappa leather seats to Audi exclusive door sill trims, every detail has been chosen to truly enhance your drive.



Paint

We believe that every part of your car should have a personal touch. Which is why you can choose from a wide range of paint colours and finishes, from standard shades to metallic and pearl effects. We can even mix a customised colour for you to create the perfect fit.

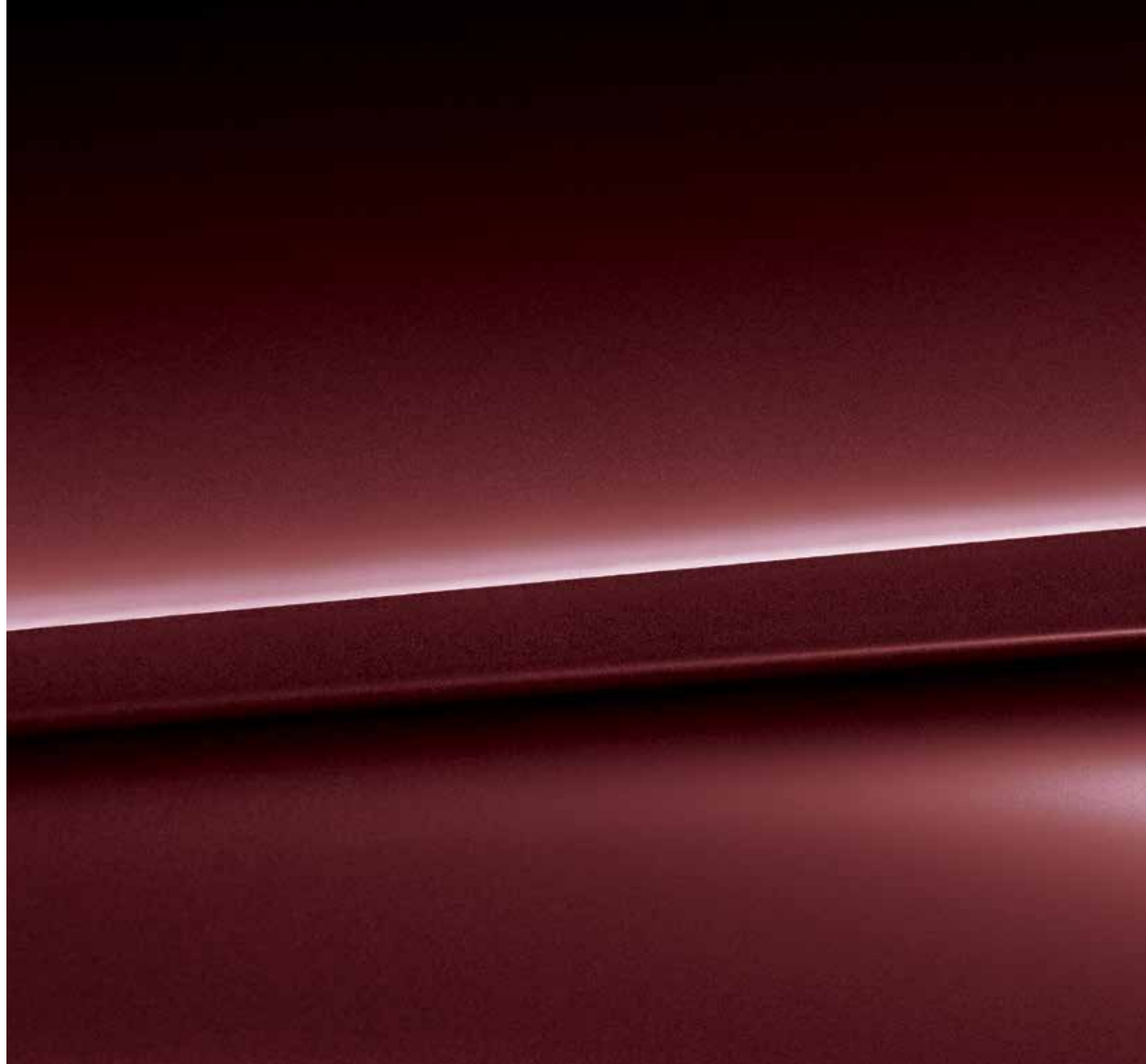

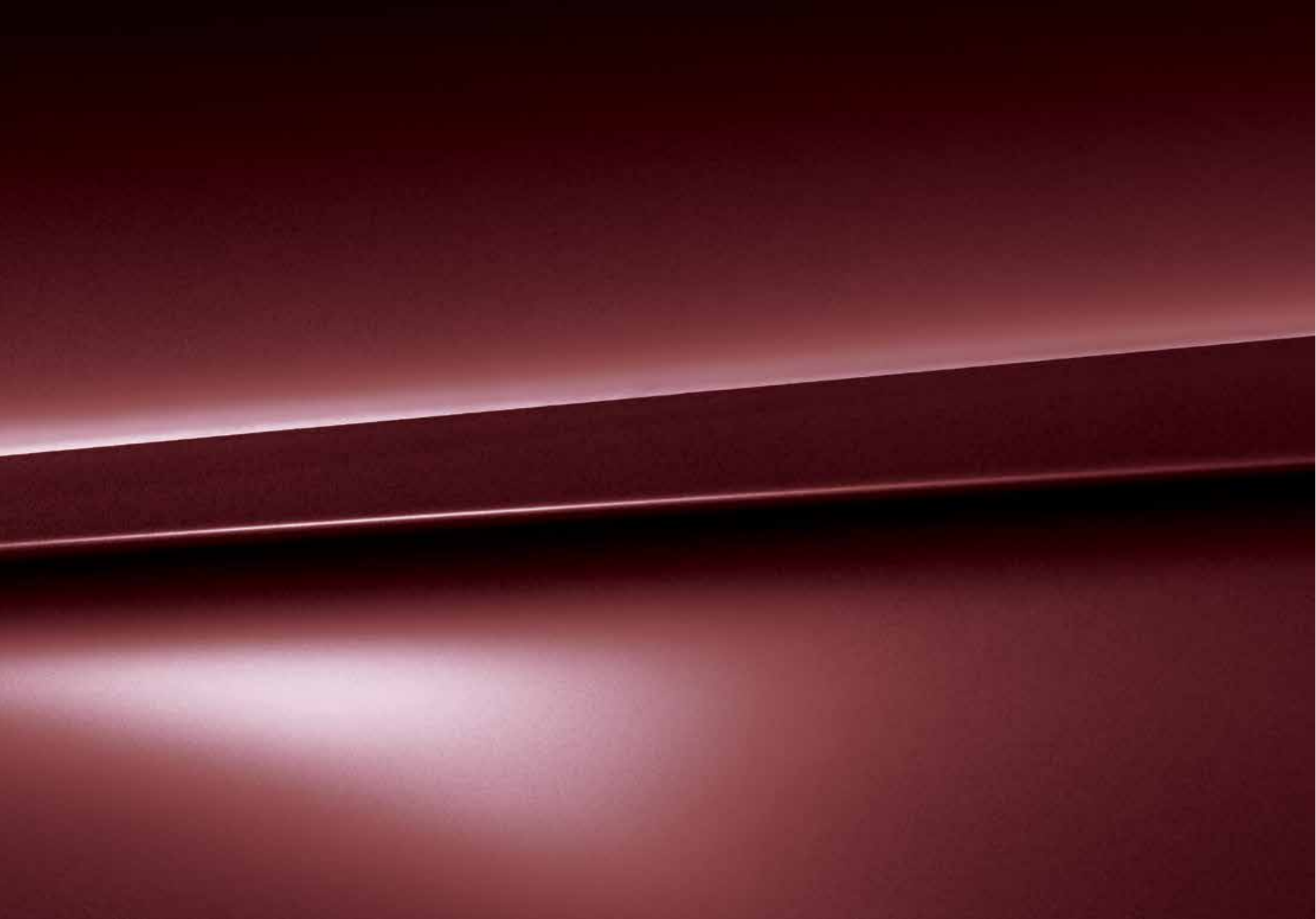

Paint

You can select one of the standard colours shown opposite or, for a different look, choose from a range of optional finishes.

Standard colours



Ibis white – T9

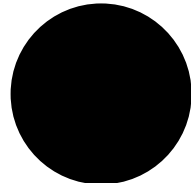

Brilliant black – A2

Optional colours

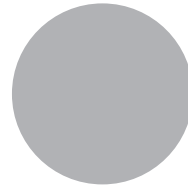

Ice silver, metallic – P5

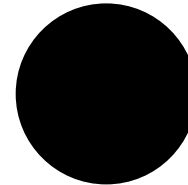

Phantom black, pearl effect – L8

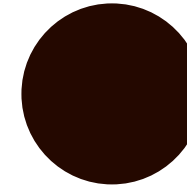

Teak brown, metallic* – 4U

S line colour

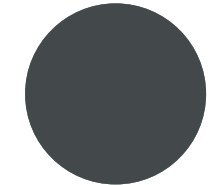

Daytona grey, pearl effect* – 6Y



Glacier white, metallic – 2Y

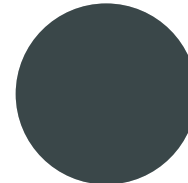

Monsoon grey, metallic – 0C

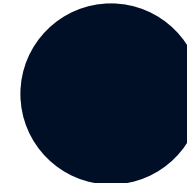

Moonlight blue, metallic – W1

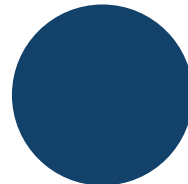

Scuba blue, metallic* – S9

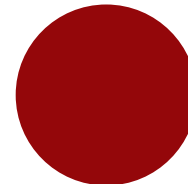

Volcano red, metallic – 1G

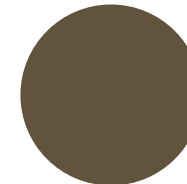

Maya brown, metallic* – G4

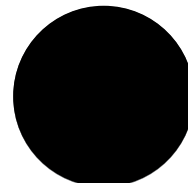

Lava grey, pearl effect – 1R

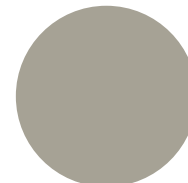

Cuvee silver, metallic* – 0D

* Not available on SQ5

** On S line Plus trim the optional colours have no charge

All the colour swatches on this page are matched as accurately as possible to the actual paint colours used. However, due to print processes, Audi UK cannot guarantee that colours shown are 100% accurate.

Visit your local Audi Centre for a more accurate colour swatch.

Options are subject to availability and may extend delivery.

RRP – Recommended Retail Price.

VAT is calculated at 20% but this may alter to reflect any change in the applicable VAT rate.

Optional colours**

Basic RRP
£512.50

Total RRP inc VAT
£615.00

SQ5 colours

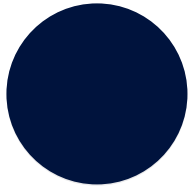

Estoril blue, crystal effect - K0

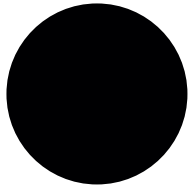

Panther black, crystal effect - H8

Optional colours Crystal effect

Basic RRP
£720.83

Total RRP inc VAT
£865.00

Paint

Audi exclusive

Everyone has a favourite colour. No matter what yours is, Audi exclusive provides a range of unique colours that have been designed to set your car apart. Choose from the swatches here, or specify any other paint colour in the Audi range – whether it's Sepang blue from the Audi R8 or Alpine white from the original Audi quattro, the choice is yours.

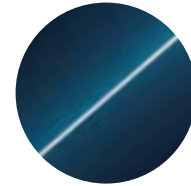

Palace blue, pearl effect

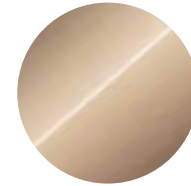

Sand beige, pearl effect

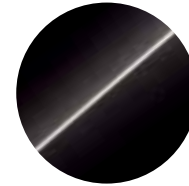

Saddle brown, pearl effect

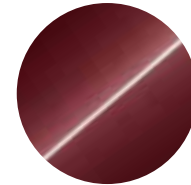

Classic red, pearl effect

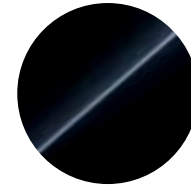

Mamba black, metallic

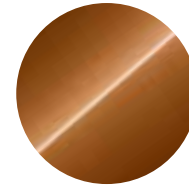

Ipanema brown, metallic



Any colour in the Audi range or 100 exclusive colours to choose from**

Audi exclusive

Basic RRP
£1,762.50

Total RRP inc VAT
£2,115.00

Customised

If you have a particular colour in mind, we'll mix the exact metallic or pearl-effect shade you want.*

*Customised paint is subject to factory approval, and is available for metallic and pearl-effect water-based paints only. Three-colour process colours and two-tone schemes are not available.

**Visit your local Audi Centre for colour samples.

All the colour swatches on this page are matched as accurately as possible to the actual paint colours used. However, due to print processes, Audi UK cannot guarantee that colours shown are 100% accurate.

Visit your local Audi Centre for a more accurate colour swatch.

RRP - Recommended Retail Price.

VAT is calculated at 20% but this may alter to reflect any change in the applicable VAT rate.



Customised paint

Customised*

Basic RRP
£2,179.17

Total RRP inc VAT
£2,615.00

Upholstery

It's important to feel comfortable on the road. Just choose from our range of luxury upholstery materials and textures, including additional support and colour options, for complete relaxation while you drive.





Upholstery

Standard seats

Choose your favourite upholstery from the swatches shown opposite to give your car's interior the look and feel you want.

Milano leather



Black - FZ

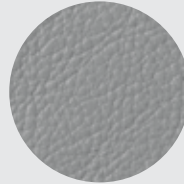

Titanium grey - IE

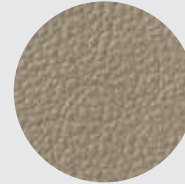

Pistachio beige - VI

Fine Nappa leather*



Black - FZ

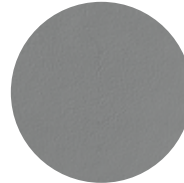

Titanium grey - IE/IK



Chestnut brown - VR



Pistachio beige - VI

SE	S line	S line Plus	SQ5	Basic RRP	Total RRP inc VAT
S	-	-	-	No charge	No charge
•	-	-	-	£341.67	£410.00

*Includes leather door armrests (7HB)

Options are subject to availability and may extend delivery.

- = Not available
• = Available
S = Standard







RRP - Recommended Retail Price.

VAT is calculated at 20% but this may alter to reflect any change in the applicable VAT rate.

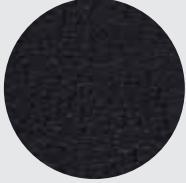
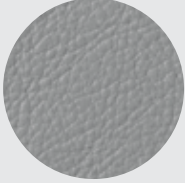
Upholstery

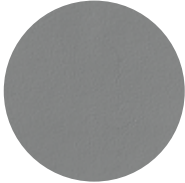
Sports seats

With electric lumbar support.

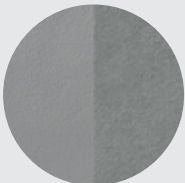
					SE	S line	S line Plus	SQ5	Basic RRP	Total RRP inc VAT	
Milano leather					•	-	-	-	£341.67	£410.00	
	Black - FZ	Titanium grey - IE	Pistachio beige - VI								
	Fine Nappa leather*					•	-	-	-	£645.83	£775.00
Black - FZ		Titanium grey - IE/IK	Chestnut brown - VR	Pistachio beige - VI							
Leather/Alcantara						•	-	-	-	No charge	No charge
		Black - FZ	Titanium grey - IE								



Fine Nappa leather Sports seat in Chestnut brown

*Includes leather door armrests (7HB)

Options are subject to availability and may extend delivery.

- = Not available
• = Available
S = Standard

RRP - Recommended Retail Price.

VAT is calculated at 20% but this may alter to reflect any change in the applicable VAT rate.

Upholstery

Climate Comfort seats

Front Climate Comfort seats with perforated leather on the actively ventilated and heated areas of the front seats, and on the non-ventilated areas of the rear seats.

Also includes:

- electrical adjustment for height, forwards and backwards position, backrest angle and lumbar support
- memory function for driver's seat
- folding and auto-dimming door mirrors with memory function and automatic kerb view function, which tilts the passenger mirror downwards towards the kerb when reverse gear is engaged.

Options are subject to availability and may extend delivery.

- = Not available
- = Available
- S = Standard

RRP – Recommended Retail Price.

VAT is calculated at 20% but this may alter to reflect any change in the applicable VAT rate.

Milano leather



Black – FZ

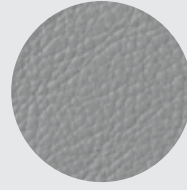

Titanium grey – IE



Pistachio beige – VI



Chestnut brown – VR

SE	S line	S line Plus	SQ5	Basic RRP	Total RRP inc VAT
•	-	-	-	£1,795.83	£2,155.00



Climate controlled Comfort seat in Milano leather, Pistachio beige

Upholstery

S line Sports seats

Front Sport seats with S line embossing and prominent side bolsters for lateral support when cornering. Also features electric 4-way lumbar support and manual seat cushion angle adjustment with extendable thigh support.

Fine Nappa
leather



Black - QE

Perforated
leather/Alcantara



Black with Silver stitching - QF

	SE	S line	S line Plus	SQ5	Basic RRP	Total RRP inc VAT
Fine Nappa leather	-	S	S	-	No charge	No charge
Perforated leather/Alcantara	-	•	•	-	No charge	No charge

Options are subject to availability and may extend delivery.

- = Not available
• = Available
S = Standard

RRP - Recommended Retail Price.

VAT is calculated at 20% but this may alter to reflect any change in the applicable VAT rate.

Upholstery and seats

SQ5 Sports seats

Electrically-adjustable front seats with SQ5 embossing. Includes adjustment for height, forwards and backwards position, backrest angle and lumbar support.

Fine Nappa leather



Black/Black - XG/IM

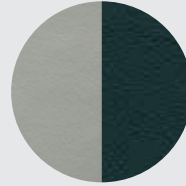

Lunar silver/Black - XO/XN



Magma red/Black - FA/SZ

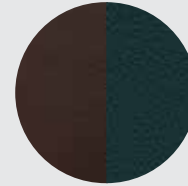

Chestnut brown/Black - SV/WY

SE	S line	S line Plus	SQ5	Basic RRP	Total RRP inc VAT
-	-	-	S	No charge	No charge



SQ5 Sports seat with electrically adjustable front seats

Options are subject to availability and may extend delivery.

- = Not available
- = Available
- S = Standard

RRP - Recommended Retail Price.

VAT is calculated at 20% but this may alter to reflect any change in the applicable VAT rate.

Seats

Choose from a variety of different seat options, so you can maintain the right driving posture at all times.

Order Code		SE	S line	S line Plus	SQ5	Basic RRP	Total RRP inc VAT
4A3	Heated front seats. Individually controlled variable temperature adjustment	●	●	●	●	£250.00	£300.00
4A4	Heated front and rear seats. Individually controlled variable temperature adjustment. Only available in combination with leather upholstery	●	●	●	●	£383.33	£460.00
PV1	Electrically-adjustable front seats. Includes adjustment for height, forwards and backwards position, backrest angle and lumbar support In combination with Sports seats	●	—	—	—	£637.50	£765.00
		●	●	●	S	£466.67	£560.00
PV3 6XL	Electrically-adjustable front seats with memory function and lumbar support. Comprising electric front seats with memory function on driver's side and lumbar support. Also includes folding and auto-dimming door mirrors with memory function and automatic kerb view function, which tilts the passenger mirror downwards towards the kerb when reverse gear is engaged In combination with Sport seats	●	—	—	—	£904.17	£1,085.00
		●	●	●	—	£708.33	£850.00
		—	—	—	●	£375.00	£450.00
7P1	Electric lumbar support. For front seats with horizontal and vertical adjustment	●	S	S	S	£195.83	£235.00
Q2N	Folding front passenger seat. Not available with lumbar support, S line or electric seats	●	—	—	—	£108.33	£130.00
5KA	Rear bench seat plus. Allows both the 1/3 and 2/3 sections of the rear bench seat to be independently adjusted by 100mm forwards and backwards. Also includes a through-load facility with an integral centre armrest containing 2 cup holders	●	●	●	●	£145.83	£175.00

Options are subject to availability and may extend delivery.

- = Not available
- = Available
- S = Standard

RRP – Recommended Retail Price.

VAT is calculated at 20% but this may alter to reflect any change in the applicable VAT rate.



Electrically-adjustable front seats



Rear bench seat plus

Colour and trim guide

Interior trim colours

Standard seats

To help you choose the right interior for your new Audi Q5, please use this guide, showing the carpet, dashboard and headlining colours that have been matched to your chosen upholstery.

Order Code	Upholstery	Carpet	Dashboard (upper/lower)	Headlining	Milano leather (PEB)	Fine Nappa leather (PEC and 7HB/7HC)
IE	Titanium grey	Steel grey	Steel grey	Moon silver	●	●
FZ	Black	Black	Black	Moon silver	●	●
VI	Pistachio beige	Truffle beige	Truffle beige	Silk beige	●	●
IK	Titanium grey	Black	Black	Moon silver	—	●
VR	Chestnut brown	Black	Black	Moon silver	—	●

Sports seats

Order Code	Upholstery	Carpet	Dashboard (upper/lower)	Headlining	Leather/Alcantara (PED)	Milano leather (PEL)	Fine Nappa leather (PEE and 7HB/7HC)
FZ	Black	Black	Black	Moon silver	●	●	●
IE	Titanium grey	Steel grey	Steel grey	Moon silver	●	●	●
VI	Pistachio beige	Truffle beige	Truffle beige	Silk beige	—	●	●
IK	Titanium grey	Black	Black	Moon silver	—	—	●
VR	Chestnut brown	Black	Black	Moon silver	—	—	●

Climate Comfort seats (PS8)

Order Code	Upholstery	Carpet	Dashboard (upper/lower)	Headlining	Milano leather (PEB)
IE	Titanium grey	Black/Black	Steel grey	Lunar silver	●
FZ	Black	Black/Black	Black	Lunar silver	●
VI	Pistachio beige	Black/Black	Truffle beige	Truffle beige	●
VR	Chestnut brown	Black/Black	Black	Lunar silver	●

Options are subject to availability and may extend delivery.

— = Not available
● = Available
S = Standard

RRP – Recommended Retail Price.

VAT is calculated at 20% but this may alter to reflect any change in the applicable VAT rate.

Colour and trim guide

Interior trim colours

S line seats

Order Code	Upholstery	Carpet	Dashboard (upper/lower)	Headlining	Perforated leather/Alcantara (N7K)	Fine Nappa leather (N2R)
QE	Black	Black/Black	Black	Black	—	●
QF	Black/Black silver	Black/Black	Black	Black	●	—

SQ5 Sports seats

Order Code	Upholstery	Carpet	Dashboard (upper/lower)	Headlining	Fine Nappa leather (N3M)
XG or IM*	Black/Black	Black	Black	Black or silver	●
XO or XN*	Lunar silver/Black	Black	Black	Black or silver	●
FA or SZ***	Magma red/Black	Black	Black	Black or silver	●
SV or WY**	Chestnut brown/Black	Black	Black	Black or silver	●

Options are subject to availability and may extend delivery.

— = Not available
 ● = Available
 S = Standard

*Stitching in Dark silver

**Stitching in Chestnut brown

***Stitching in Magma red

RRP – Recommended Retail Price.

VAT is calculated at 20% but this may alter to reflect any change in the applicable VAT rate.

Upholstery

Audi exclusive

With Audi exclusive, you can specify your seats in Fine Nappa leather, Valcona leather or Valcona leather/Alcantara in an array of different colours shown to the right.

Select just one all-over shade for each seat, or customise each panel in two or more complementary colours from the distinctive Audi exclusive palette. You can even choose the colour of the decorative stitching – to match or contrast with your chosen upholstery – from this varied collection. Whatever combination you decide upon, we think you'll be extremely comfortable with the result.



Chestnut brown



Jet grey



Alabaster white

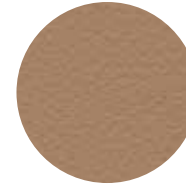

Sand beige

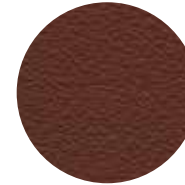

Saddle brown

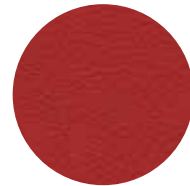

Crimson red



Magnolia white



Havana brown

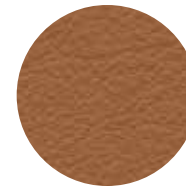

Cognac brown

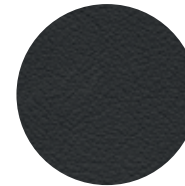

Night blue



Cloudy grey



Smoky blue

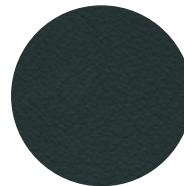

Iceland green



Powder beige

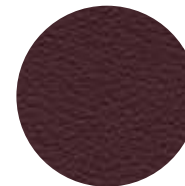

Classic red

Also available:

Alcantara colours: available in all the Audi exclusive colours shown, except for Crimson red and Sand beige. Alcantara equivalents are Chilli red and Sesame beige respectively.

Please consult your Audi Centre for examples of Alcantara and carpet colours.

Upholstery

Audi exclusive

Order Code		SE	S line	S line Plus	SQ5	Basic RRP	Total RRP inc VAT
PYA S3G	Audi exclusive leather package 1 in Fine Nappa leather. Includes leather-covered seat upholstery, door armrests, door trims and front centre armrest. Backrest covers and seat add-on parts come in the interior trim colour*	●	—	—	—	£1,779.17	£2,135.00
PYB S3G	Audi exclusive leather package 1 in Valcona leather with climate comfort seats. Includes leather-covered seat upholstery, door armrests, door trims and front centre armrest. Backrest covers and seat add-on parts come in the interior trim colour*	●	—	—	—	£4,712.50	£5,655.00
PYC S3G	Audi exclusive leather package 1 in Valcona leather/Alcantara. Includes leather-covered seat-side trims, head restraints, door armrests, front centre armrest and Alcantara seat-centre sections and door trim inserts. Backrest covers and seat add-on parts come in the interior trim colour*	●	—	—	—	£2,120.83	£2,545.00
		—	●	●	●	£1,779.17	£2,135.00
PYD S3G	Audi exclusive leather package 2 in Fine Nappa leather. Includes all the contents of leather package 1 (PYA/S3G) plus leather-covered seat backrest covers and colour-coordinated seat-side trims and add-on parts	●	—	—	—	£3,020.83	£3,625.00
PYE S3G	Audi exclusive leather package 2 in Valcona leather with climate comfort seats. Includes all the contents of leather package 1 (PYB/S3G) plus leather-covered seat backrest covers. Seat-side trims and add-on parts are colour-coordinated	●	—	—	—	£5,958.33	£7,150.00
PYG S3G	Audi exclusive leather package 1 in Fine Nappa leather with Sports seats. Includes all the contents of leather package 1 (PYA/S3G) plus leather-covered front Sports seats	●	—	—	—	£2,120.83	£2,545.00
		—	●	●	●	£1,779.17	£2,135.00
PYJ S3G	Audi exclusive leather package 2 in Fine Nappa leather with Sports seats. Includes all the contents of leather package 1 (PYA/S3G) plus leather-covered Sports seats, seat backrest covers. Seat-side trims and add-on parts are colour-coordinated	●	—	—	—	£3,366.67	£4,040.00
		—	●	●	●	£3,025.00	£3,630.00

Options are subject to availability and may extend delivery.

— = Not available
● = Available
S = Standard

*Leather and stitching (where applicable) colours can be specified in a variety of colours from the Audi exclusive range.

RRP – Recommended Retail Price.

VAT is calculated at 20% but this may alter to reflect any change in the applicable VAT rate.

Upholstery

Audi exclusive line

Audi exclusive is ultimately about choice – but if you'd rather leave some of the decisions in the capable hands of our designers, the expert team at quattro GmbH have compiled Audi exclusive line, combining some of the most popular elements of the exclusive range in one, beautifully coordinated package.

Options are subject to availability and may extend delivery.

- = Not available
• = Available
S = Standard

*When ordered in combination with S line, Audi exclusive removes all S line interior badging.

**When ordered in combination with S line, the S line embossing on the seats is removed.

RRP – Recommended Retail Price.

VAT is calculated at 20% but this may alter to reflect any change in the applicable VAT rate.

Order Code	SE	S line	S line Plus	SQ5	Basic RRP	Total RRP inc VAT
WQK Audi exclusive line	•	–	–	–	£2,058.33	£2,470.00
PQL Audi exclusive line*	–	•	•	–	£708.33	£850.00



Alabaster white – UA



Cloudy grey – UH



Cognac brown – QX

This package includes

- ▶ Two-colour seat upholstery in Fine Nappa leather (black seat-side sections, seat-centre section in Alabaster white, Cloudy grey or Cognac brown)**
 - ▶ Seat-side sections and head restraints with coloured piping (to match seat-centre section)
 - ▶ Sports seats including electric lumbar support
 - ▶ Black interior including black add-on seat parts
 - ▶ Headlining in black cloth
 - ▶ Audi exclusive door sill trims, additional stainless steel loading lip cover
 - ▶ Leather-covered cockpit on driver's side in black with coloured stitching
 - ▶ Inlays in Walnut, balsamic brown (SE only), Matt-brushed aluminium or Piano black finish
 - ▶ Leather-covered Sports steering wheel in 3-spoke design with coloured stitching (to match seat-centre section)
 - ▶ Gear-lever gaiter with coloured stitching (to match seat-centre section)
 - ▶ Door trim in leather matched to seat-centre section
 - ▶ Armrest and door trims in leather with coloured stitching (to match seat-centre section)
 - ▶ Floor mats with coloured piping (to match seat-centre section)
- Can only be ordered in conjunction with rear bench seat (SKA)



Inlays

Attention to detail can make a big impact. From contemporary black Piano finish to a brown walnut, our selection of inlays make the perfect finishing touch to your car's interior.





Inlays

Inlays are the all-important finishing touch that add flair and interest to your car's interior.

Order Code		SE	S line	S line Plus	SQ5	Basic RRP	Total RRP inc VAT
5MF	Aluminium satellite	S	-	-	-	No charge	No charge
5TG	Matt-brushed aluminium	-	S	S	S	No charge	No charge
5MT	Beaufort oak, light brown	●	-	-	-	£170.83	£205.00
5MG	Walnut, balsamic brown	●	-	-	-	£170.83	£205.00
7TL	Fine grain ash, natural	●	-	-	-	£170.83	£205.00
5MK	Carbon atlas	-	-	-	●	£212.50	£255.00
5TL	Piano finish, black	-	●	●	●	£254.17	£305.00
5TB	Aluminium, beaufort	-	●	●	●	£791.67	£950.00

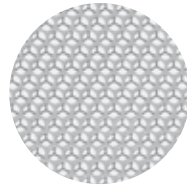

Aluminium satellite – 5MF



Matt-brushed aluminium – 5TG

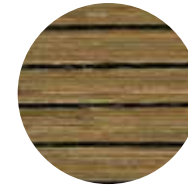

Beaufort oak, light brown – 5MT



Walnut, balsamic brown – 5MG



Fine grain ash, natural – 7TL

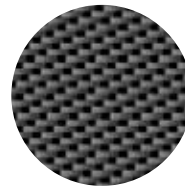

Carbon atlas – 5MK

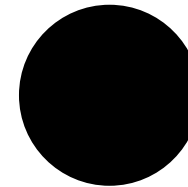

Piano finish, black – 5TL



Aluminium, beaufort – 5TB

Options are subject to availability and may extend delivery.

- = Not available
● = Available
S = Standard

RRP – Recommended Retail Price.

VAT is calculated at 20% but this may alter to reflect any change in the applicable VAT rate.

Inlays

Audi exclusive

Audi exclusive has sourced a wide range of materials which you can select for your inlays, from Sepia oak to Fine grain myrtle.

Order Code		SE	S line	S line Plus	SQ5	Basic RRP	Total RRP inc VAT
YTA S3G	Audi exclusive inlays (cannot be combined with the inlays shown on page 54)	●	●	●	●	£758.33	£910.00
YTE S3G	Audi exclusive carbon	–	●	●	●	£937.50	£1,125.00



Fine grain ash, nougat



Fine grain myrtle, nutmeg



Oak, sepia

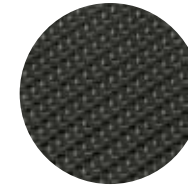

Carbon

Options are subject to availability and may extend delivery.

- = Not available
- = Available
- S = Standard

RRP – Recommended Retail Price.

VAT is calculated at 20% but this may alter to reflect any change in the applicable VAT rate.

Options

Every driver has different needs, which is why we have created some useful options to further enhance your car. For extra comfort, support, style or function, you can choose from a variety of additional features, tailoring everything from your infotainment and audio equipment to your wheels and lighting.





Wheels, tyres and suspension

Choose a set of specially-selected alloy wheels to subtly enhance the way your car looks and drives. And you can also specify Audi drive select, which allows you to change suspension and steering settings according to your driving style.



19" x 8J '5-arm Star' design alloy wheels – PRV



19" x 8J '5-arm' design alloy wheels, partly polished – PRL



19" x 8J '5-arm off-road' design alloy wheels – PQ2



20" x 8.5J '5-segment-spoke' design alloy wheels – PQ6



20" x 8.5J '5-twin-spoke off-road' design alloy wheels* – PQ7



20" x 8.5J '5-segment' design alloy wheels in Titanium Optic finish – PQK



20" x 8.5J '7-double-spoke' design alloy wheels* – PQF



20" x 8.5J '20-spoke' design alloy wheels* – PQS



20" x 8.5J '5-arm' design alloy wheels, partly polished – PR1



21" x 8.5J '5-twin-spoke Star' design alloy wheels in titanium look with a high gloss finish* – PQ8

*Please note: this option includes a small extension to the wheel arches.

On S line trims the wheel arch is matt black, while on SE models it matches the colour of the contrasting bumpers.

Wheels, tyres and suspension

Order Code	SE	S line	S line Plus	SQ5	Basic RRP	Total RRP inc VAT
PRV 19" x 8J '5-arm Star' design alloy wheels with 235/55 R19 tyres	●	-	-	-	£425.00	£510.00
PRL 19" x 8J '5-arm' design alloy wheels, partly polished with 235/55 R19 tyres	●	-	-	-	£425.00	£510.00
PQ2 19" x 8J '5-arm off-road' design alloy wheels with 235/55 R19 tyres. Only available in conjunction with off-road styling package - PKQ	●	-	-	-	£541.67	£650.00
PQ6 20" x 8.5J '5-segment-spoke' design alloy wheels with 255/45 R20 tyres	● -	- ●	- S	-	£1,041.67 £425.00	£1,250.00 £510.00
PQ7 20" x 8.5J '5-twin-spoke off-road' design alloy wheels with 255/45 R20 tyres.* Only available in conjunction with off-road styling package - PKQ, except on S line Plus and SQ5	● -	- -	- ●	● -	£425.00 No charge	£510.00 No charge
PQK 20" x 8.5J '5-segment' design alloy wheels in Titanium Optic finish with 255/45 R20 tyres	- -	● -	- ●	-	£541.67 £425.00	£650.00 £510.00
PQF 20" x 8.5J '7-double-spoke' design alloy wheels with 255/45 R20 tyres*	● -	- ●	- -	- ●	£1,041.67 £425.00	£1,250.00 £510.00
PQS 20" x 8.5J '20-spoke' design two-piece alloy wheels with 255/45 R20 tyres*	● -	- ●	- -	-	£1,041.67 £425.00	£1,250.00 £510.00
PR1 20" x 8.5J '5-arm' design alloy wheels, partly polished with 235/45 R20 tyres	●	-	-	-	£1,041.67	£1,250.00
PQ8 21" x 8.5J '5-twin-spoke Star' design alloy wheels in titanium look with a high gloss finish with 255/40 R21 tyres*	-	-	-	●	£1,041.67	£1,250.00

Options are subject to availability and may extend delivery.

- = Not available
● = Available
S = Standard

*Please note: this option includes a small extension to the wheel arches.

On S line trims the wheel arch is matt black, while on SE models, it matches the colour of the contrasting bumpers.

RRP - Recommended Retail Price.

VAT is calculated at 20% but this may alter to reflect any change in the applicable VAT rate.

Wheels, tyres and suspension

Order Code		SE	S line	S line Plus	SQ5	Basic RRP	Total RRP inc VAT
2H1	Audi drive select – changes your car’s handling and responses at the touch of a button to suit the way you want to drive. There are five modes: comfort, dynamic, auto, efficiency and individual. Please note that you can only choose the ‘individual’ mode and customise your settings if you also have Technology Package installed	●	●	●	●	£183.33	£220.00
1N8	Dynamic steering. With this new technology, driving is significantly more agile under everyday conditions, while directional stability and precision are increased at high speeds and in demanding driving situations (must be combined with Audi drive select – 2H1)	●	●	●	●	£312.50	£375.00
1BL	Damper control – formed on the basis of lowered Sports suspension, the optional damper control system fine-tunes suspension settings according to road conditions and driver needs (must be combined with Audi drive select – 2H1)	●	●	●	–	£566.67	£680.00
1BV	S line Sports suspension (not lowered)	–	●	●	–	No charge	No charge
7K6	Tyre pressure loss indicator. A visual and acoustic warning when the system detects a potential loss of tyre pressure	●	●	●	●	£62.50	£75.00

Options are subject to availability and may extend delivery.

- = Not available
- = Available
- S = Standard

RRP – Recommended Retail Price.

VAT is calculated at 20% but this may alter to reflect any change in the applicable VAT rate.



Packages

Some items work well together, which is why we've created these special packages. They provide increased convenience and value, by combining several of our most popular options.

Order Code	SE	S line	S line Plus	SQ5	Basic RRP	Total RRP inc VAT
WB7 Technology package Featuring MMI Navigation system – HDD-based with Audi Music Interface and Audi parking system plus MMI Navigation system plus . Hard disk navigation with topographical map display, places of interest and town models in 3D, with high-resolution 7" colour TFT display. The system offers three alternative routes, with the ability to scroll along the selected route and manoeuvre within the map. Uses 7-digit postcode recognition. Includes split-screen mode for route information, dynamic route guidance (TMC), intersection zoom function, motorway exits and lane recommendations in Driver's Information System (DIS). When combined with Mobile telephone preparation – High with Audi connect (9ZW), the system uses Google Earth images for navigation. Includes 2 SD card readers, single CD/DVD player and 40GB hard drive, Jukebox (20GB) for storing and managing music files in WMA and MP3 format. Includes European navigation data (where digitised) Audi Music Interface . Connection for use with stereo audio sources, USB and MP3 devices including Apple iPod generation 4 onwards and Apple iPhone Audi parking system plus . Acoustic and visual park assist system for the front and rear	•	•	S	•	£1,412.50	£1,695.00

Options are subject to availability and may extend delivery.

- = Not available
- = Available
- S = Standard

RRP – Recommended Retail Price.

VAT is calculated at 20% but this may alter to reflect any change in the applicable VAT rate.

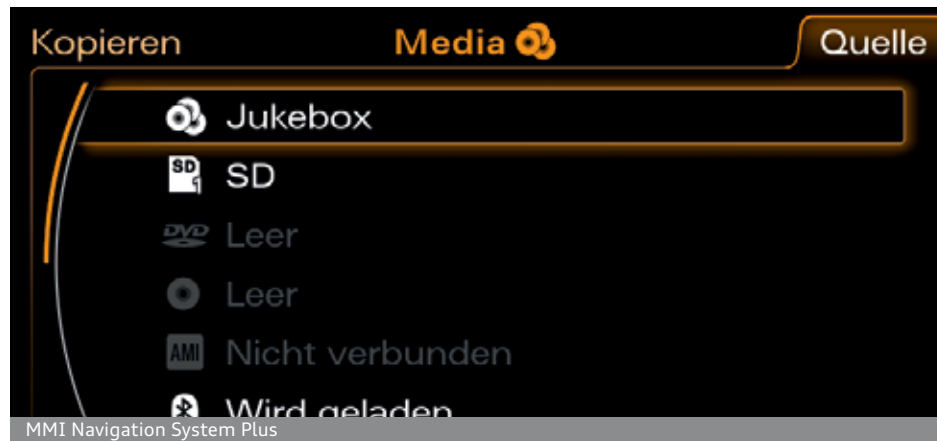

Packages

Order Code	SE	S line	S line Plus	SQ5	Basic RRP	Total RRP inc VAT
PCB WB7	●	●	—	●	£1,933.33	£2,320.00
	—	—	●	—	£520.83	£625.00
PKQ 7M4	●	—	—	—	£1,495.83	£1,795.00

Technology package – Advanced. Includes all the features of Technology package as well as **Adaptive cruise control with braking guard.** Intelligent automatic speed and distance control system. Works at speeds from 19-155mph, using radar sensors to measure and maintain required distance to vehicle ahead by braking and accelerating. Four programmes (distance 1 to distance 4) set via steering column controls of the cruise control system. Includes Audi braking guard – a system which triggers a visual and acoustic alarm when it detects the risk of a rear end collision with the vehicle in front. At speeds below 19mph, the system can initiate partial braking or full deceleration if a potential impact is detected or if it is not possible to completely prevent a collision, the system will focus on reducing the speed at which the vehicles collide
Audi active lane assist. Helps the driver to stay in lane with gentle steering impulses for greater safety and convenience, particularly on motorways and country roads. The system informs the driver if the car is drifting out of its lane unintentionally

Off-road package. Includes front and rear bumpers, side ventilation grilles, door capping strips and wheel arch extensions in a striking off-road design. Designer stainless steel underbody guards on the front and rear bumpers. Audi exclusive doorsill trims and loading-sill protector in stainless steel. Only available in combination with PQ2, PQ6, PQ7, PQF or PQS

Options are subject to availability and may extend delivery.

- = Not available
- = Available
- S = Standard

RRP – Recommended Retail Price.

VAT is calculated at 20% but this may alter to reflect any change in the applicable VAT rate.



Audi active lane assist



Off-road package with 20" x 8.5J '5-double-spoke off-road' design alloy wheels (PQ7)

Audio and communication

Stay in touch using our range of communication functions, and give each journey its own soundtrack with our advanced audio equipment.

Order Code		SE	S line	S line Plus	SQ5	Basic RRP	Total RRP inc VAT
8UM	Audi Symphony radio. AM/FM twin tuner with TP memo function. Front-loading 6-CD changer with MP3 compatibility and active front and rear speakers. Includes colour centre console screen, SD memory-card reader and AUX-IN socket. Cannot be combined with Technology Package	●	●	I	●	£191.67	£230.00
QU6	TV reception – digital. TV tuner for reception of ‘free-to-air’ TV channels. Picture display only possible on MMI screen when vehicle is stationary, audio available at all times. Reception dependent upon local digital network availability. Only in combination with Technology package (WB7)	●	●	●	●	£687.50	£825.00
9VK	Bang & Olufsen® sound system. Designed specifically for the Audi Q5, featuring 14 high-performance speakers and two amplifiers which create 505 watts of stunning sound, balanced to suit the specific acoustic properties of the car’s interior. The system constantly and automatically adapts the sound characteristics to the vehicle’s speed and background noise providing the highest level of quality. The reproduction of 5.1 surround sound is possible in conjunction with Technology package (WB7)	●	●	●	●	£445.83	£535.00

Options are subject to availability and may extend delivery.

- = Not available
- = Available
- S = Standard

RRP – Recommended Retail Price.

VAT is calculated at 20% but this may alter to reflect any change in the applicable VAT rate.



Audi Music Interface



Control panel for HDD Satellite Navigation and MMI



MMI media options menu



Bang & Olufsen® sound system

Audio and communication

Order Code		SE	S line	S line Plus	SQ5	Basic RRP	Total RRP inc VAT
PT5	Mobile telephone preparation – Low with Bluetooth and voice control. Provides hands-free connection via Bluetooth using mobile phone aerial. Alternatively, it can use a cradle with charging facility for optimal reception via external aerial located in front centre armrest (included). Cradle available at extra cost – please contact your Audi Centre for phone compatibility	●	●	●	●	£145.83	£175.00
9ZW	Mobile telephone preparation – High with Audi connect. Audi connect provides access to a number of innovative online services via an internal UMTS (3G) module. Audi connect online services include: navigation using Google Earth images and Google Street View, destination entry via Google Maps or myAudi, online point of interest search and information services such as weather forecasts and the latest world news. Audi connect also includes Audi traffic information online, which gives accurate real-time forecasts of the traffic situation along the chosen route. The traffic situation can be displayed on the navigation map or Google Earth image. Audi connect can also create a Wi-Fi hotspot in the car for convenient internet access using a mobile device (e.g. laptop or tablet). Many Audi connect features can be simply operated via MMI Navigation Plus, the multi-function steering wheel or the voice control system. Only in combination with Technology package (WB6) Important connectivity information: An external data source is required to enable the Audi connect online services. One of the two following external data sources can be used ¹ : 1. A mobile telephone with Bluetooth SIM Access Profile ² 2. A separate SIM card which can be inserted in the included SIM card reader. When a separate SIM card is used, hands free phone calls are possible using the SIM card or by connecting a different mobile telephone via Bluetooth Hands Free Profile	●	●	●	●	£291.67	£350.00
UF7	Audi Music Interface (AMI). Universal connection for use with stereo audio sources, USB and MP3 devices including Apple iPod generation 4 onwards (iPod, iPod classic, iPod mini, iPod nano, iPod photo, iPod video, iPod Touch). Provides intuitive control through the audio system and multi-function steering wheel (where fitted). It also replicates the iPod display on the audio screen and DIS, including track titles. The interface provides charging function (dependent on device). Includes 2 cables to connect your iPod or USB MP3 device	●	●	S	●	£212.50	£255.00
7D1	CD changer and DVD player. 6-CD changer located in the glovebox and single CD/DVD slot in centre console. Only available with Technology package (WB7)	●	●	●	●	£304.17	£365.00
9WM	Rear Seat Entertainment. Includes two detachable DVD players/monitors fitted to the back of the front seats (supplied by Audi Genuine Accessories). The backs of the front seats are fitted with mountings and power connections. The system can be used outside the car with a rechargeable battery or mains power connection, which is included in the package. Includes individual remote controls and two sets of headphones	●	●	●	●	£875.00	£1,050.00

Options are subject to availability and may extend delivery.

-- = Not available
● = Available
S = Standard

¹Online services are only available for mobile phone contracts or SIM cards which include a data option and only within the coverage of the mobile phone network; there may be additional costs for the use of these services (charges and billing correspond to the personal mobile phone contract or SIM card contract). Due to high data volumes, a mobile phone contract including an unlimited or high usage data plan is strongly recommended. The content and scope of the online based services offered may vary.

²To check the compatibility of your mobile phone and whether it has SIM Access Profile compatibility, please visit www.audi.co.uk/owners-area/phonecompatibility.html

RRP – Recommended Retail Price.

VAT is calculated at 20% but this may alter to reflect any change in the applicable VAT rate.

Interior equipment

Specify every detail of your car's interior with this range of exclusive options.

Options are subject to availability and may extend delivery.

- = Not available
 • = Available
 S = Standard

*Homelink® is a registered trademark of Johnson Controls. For more information on compatibility visit www.homelink.com

RRP – Recommended Retail Price.

VAT is calculated at 20% but this may alter to reflect any change in the applicable VAT rate.

Order Code		SE	S line	S line Plus	SQ5	Basic RRP	Total RRP inc VAT
4F2	Advanced key. Access and authorisation system which automatically exchanges data between key and vehicle, allowing the driver to keep the key in their pocket or bag at all times. To unlock and open, simply lift the exterior door handle. To lock, press the button on the handle. Pressing the start/stop button integrated in the centre console starts and stops the engine	•	•	•	•	£391.67	£470.00
8T4	Adaptive cruise control (ACC) with braking guard. Intelligent automatic speed and distance control system. Works at speeds from 19-155mph (where law permits), using radar sensors to measure and maintain required distance to vehicle ahead by braking and accelerating. Four distance levels and four driving modes are individually selectable (dynamic, standard, comfort and efficiency). Includes Audi braking guard – a system which triggers a visual and acoustic alarm when it detects the risk of a rear end collision with the vehicle in front. At speeds below 19mph, the system can initiate partial braking or full deceleration if a potential impact is detected or if it is not possible to completely prevent a collision, the system will focus on reducing the speed at which the vehicles collide	•	•	•	•	£750.00	£900.00
VC1	Garage door opener (Homelink®). Programmable radio-operated remote control for compatible doors/gates. Control buttons integrated in the front roof module	•	•	•	•	£150.00	£180.00
QQ1	Interior light package. Includes front footwell lighting, active door reflectors, illuminated vanity mirrors, rear reading lights, entrance lights and illuminated glove compartment, vents and internal door controls	•	•	•	S	£125.00	£150.00
3FU	Open sky panoramic sunroof. Comprising glass roof with electric slide-and-tilt control and sunshade at front and rear	•	•	•	•	£937.50	£1,125.00



Advanced key start/stop button



Adaptive cruise control

Interior equipment

Order Code		SE	S line	S line Plus	SQ5	Basic RRP	Total RRP inc VAT
QE5	Storage package – including nets on the back of the front seats, storage compartment under the front seats (only under passenger seat if memory function is fitted), multi-fastening point in passenger footwell, luggage spider-net for boot floor, net under rear parcel shelf and lockable glove compartment	●	●	●	●	£104.17	£125.00
WTG	Luggage package – includes folding front passenger seat (Q2N) when ordered with Standard seats, rear bench seat plus (SKA), net partition (3CX), rail system with load-securing net (3GN) and reversible luggage compartment mat (6SJ). Not available with lumbar support, S line and electric seats	●	–	–	–	£404.17	£485.00
3GN	Load-area fixing kit. Includes telescopic bar and securing belt for dividing up luggage compartment	●	●	●	●	£150.00	£180.00
3CX	Removable net partition. Located between rear seats and rear luggage compartment. Can be used with rear seat-back in upright position, one side folded down, or completely folded down	●	●	●	●	£75.00	£90.00
3X2	Ski/snowboard bag – only in combination with rear bench seat plus (SKA)	●	●	●	●	£58.33	£70.00
6SN	Underfloor storage tray in luggage compartment. Size will differ depending on trim/options	●	●	●	●	£50.00	£60.00
6SJ	Reversible load floor mat. Luggage compartment floor mat can be reversed to provide a rubber mat which extends to protect rear bumper. Includes bumper cover	●	●	●	●	£70.83	£85.00
6SU	Underfloor storage tray in boot. Includes reversible load mat with bumper cover. Size will differ depending on trim/options	●	●	●	●	£120.83	£145.00

Options are subject to availability and may extend delivery.

– = Not available
● = Available
S = Standard

RRP – Recommended Retail Price.

VAT is calculated at 20% but this may alter to reflect any change in the applicable VAT rate.



Open sky panoramic sunroof



Open sky panoramic sunroof

Interior equipment

Order Code		SE	S line	S line Plus	SQ5	Basic RRP	Total RRP inc VAT
6NQ	Cloth headlining – black. Not available in conjunction with interior codes VI or IE	●	S	S	S	£187.50	£225.00
6NN	Alcantara headlining – light grey. Only in combination with interior light package (QQ1). Not available in combination with interior code VI or with Audi exclusive line (WQK). On SQ5, only available with interiors IM, XN, SZ, or WY	●	–	–	●	£850.00	£1,020.00
6NS	Alcantara headlining – black. Only in combination with interior light package (QQ1). Not available in combination with interior code VI or with Audi exclusive line (WQK/PQL). On SQ5, only available with interiors XG, XO, FA, or SV	●	●	●	●	£850.00	£1,020.00
7HB	Leather package – door armrests. Only in combination with leather or leather/Alcantara upholstery. When combined with S line the stitching is only in black. In combination with upholsteries UH, QX, UA the stitching is in a contrasting colour In combination with Fine Nappa leather upholstery (PEC/PEE)	●	S	S	S	£170.83	£205.00
		●	–	–	–	No charge	No charge
7HC	Leather package plus – door armrests and instrument cowling. When combined with S line, the stitching is only in black. In combination with upholsteries UH, QX, UA, the stitching is in a contrasting colour	●	–	–	–	£383.33	£460.00
		–	●	●	●	£212.50	£255.00
KT1	Climate cup holder. Allows cup holder to be cooled to 3°C or heated to 58°C. Operated via two control switches (one for hot and one for cold) positioned behind the cup holder. Located between driver and front passenger	●	●	●	●	£83.33	£100.00

Options are subject to availability and may extend delivery.

– = Not available
● = Available
S = Standard

RRP – Recommended Retail Price.

VAT is calculated at 20% but this may alter to reflect any change in the applicable VAT rate.



Climate cup holder



Leather package plus – door armrest

Interior equipment

Options are subject to availability and may extend delivery.

- = Not available
- = Available
- S = Standard

*The colours of the stitching and piping (where applicable) can be selected from any of the Audi exclusive colours shown on page 48. The carpet colour can also be selected from any of the Audi exclusive colours shown on page 48.

**Available in Chestnut brown, Saddle brown, Havana brown, Jet grey and Crimson red.

RRP – Recommended Retail Price.

VAT is calculated at 20% but this may alter to reflect any change in the applicable VAT rate.

Order Code		SE	S line	S line Plus	SQ5	Basic RRP	Total RRP inc VAT
5XF	Retractable and extendable sun visor. Extendable sun visors for both driver and front passenger, folds out and swivels to the side to help protect the driver's eyes against sunlight from the side of the vehicle. Only in combination with interior light package. Cannot be combined with Alcantara headlinings 6NS and 6NN	•	•	•	•	£37.50	£45.00
3Y4	Side window blinds – manual	•	•	•	•	£83.33	£100.00
YSQ S3G	Audi exclusive carpets.* Includes 4 Audi exclusive floor mats with leather piping. Cannot be combined with option YSR/S3G – Audi exclusive floor mats	•	•	•	•	£800.00	£960.00
YSR S3G	Audi exclusive floor mats with leather piping.* Includes 4 floor mats for front and rear. Cannot be combined with option YSQ/S3G – Audi exclusive carpets	•	•	•	•	£312.50	£375.00
YSK S3G 6NS	Audi exclusive headlining in black Alcantara with contrast stitching.* Only in combination with interior light package (QQ1)	•	•	•	•	£1,329.17	£1,595.00
YSO S3G	Audi exclusive leather-covered instrument cowl with contrasting stitching**	•	•	•	•	£729.17	£875.00



Audi exclusive upholstered headrests



Audi exclusive floor mats with leather piping

Exterior equipment

Make sure your car looks exactly as you want it to by selecting some of the striking options from our detailed list.

Options are subject to availability and may extend delivery.

- = Not available
 • = Available
 S = Standard

*Additional wiring is required for auxiliary equipment.

RRP - Recommended Retail Price.

VAT is calculated at 20% but this may alter to reflect any change in the applicable VAT rate.

Order Code		SE	S line	S line Plus	SQ5	Basic RRP	Total RRP inc VAT
8N7	High-beam assist. Automatically adjusts headlights from high-beam to dipped-beam when another vehicle is approaching	•	•	•	•	£91.67	£110.00
8Q5	Adaptive lights. Swivelling headlights for improved illumination of winding roads	-	•	•	•	£275.00	£330.00
PX1 8Q5	Adaptive Xenon headlights. Swivelling headlights for improved illumination of a winding road. Includes Xenon Plus headlights with LED daytime-running lights, headlight washers and LED rear lamps	•	-	-	-	£941.67	£1,130.00
4ZD 3S2	Black styling package - consists of black roof rails, black window surrounds, radiator grille frame in gloss black, radiator grille in matt black, number plate and fog light surround in high gloss black	-	•	•	-	£275.00	£330.00
3S2	Black Roof Rails	•	•	•	•	No charge	No charge
2Z7	Deletion of engine technology designation at rear	•	•	•	-	No charge	No charge
2Z0	Deletion of model and engine technology designation at rear	•	•	•	•	No charge	No charge
6XE	Door mirrors - electrically adjustable, folding and heated. Includes kerb view function which tilts the passenger side mirror for increased visibility whilst reversing	•	•	•	•	£158.33	£190.00
4E9	Power-operated tailgate. Opens by pressing button on the car key, button in the driver's door trim or soft-touch button in the handle recess on the luggage compartment lid. Including lid-closing assistance unit and programmable angle for the luggage compartment lid	•	•	S	•	£320.83	£385.00
4KF	Privacy glass. Dark tinted glass from B pillar backwards	•	•	S	•	£316.67	£380.00
1D4	Tow bar - swivelling. Includes single European 13-pin electric socket and may require a 13- to 7-pin adaptor. Please consult your Audi Centre for details*	•	•	•	•	£554.17	£665.00

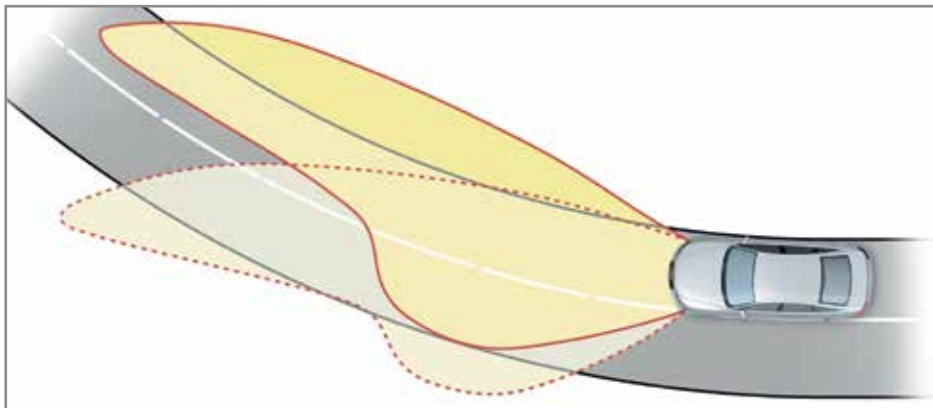

Adaptive Xenon headlights



Xenon Plus headlights (included with Adaptive headlights)

Safety and security

Intelligent technology designed to give you better all-round awareness and safety on the road.

Order Code		SE	S line	S line Plus	SQ5	Basic RRP	Total RRP inc VAT
UH2	Audi hill-hold assist. Uses either the ESP system or electromechanical parking brake to hold the vehicle stationary	●	●	●	●	£54.17	£65.00
7Y1	Audi side assist. Aids the driver when changing lane. Audi side assist monitors the area behind your car using radar sensors located discreetly in the rear bumper. It then informs the driver with a visual warning signal in the door mirror if there is a vehicle in their blind spot or approaching quickly from behind. The system is activated using a button in the driver's door. Only in combination with light and rain sensor package	●	●	●	●	£366.67	£440.00
7Y4	Audi active lane assist. Uses a discreet camera mounted at the top of the windscreen to monitor the road ahead. Helps the driver to stay in lane with gentle steering impulses. Informs driver if car is drifting out of lane unintentionally above 37mph. Choice of two settings: early steering intervention with continuous steering impulses to centre vehicle in lane; or late steering intervention, which alerts the driver that the vehicle is possibly crossing lanes and gives a corrective steering prompt	●	●	●	●	£308.33	£370.00

Options are subject to availability and may extend delivery.

- = Not available
- = Available
- S = Standard

RRP – Recommended Retail Price.

VAT is calculated at 20% but this may alter to reflect any change in the applicable VAT rate.

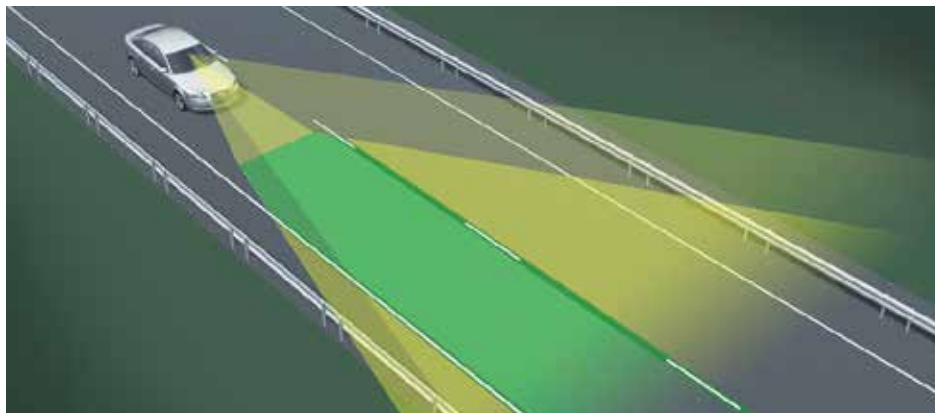

Audi lane assist



Audi lane assist – steering wheel vibration

Safety and security

Order Code		SE	S line	S line Plus	SQ5	Basic RRP	Total RRP inc VAT
7X4	Audi parking system plus. Aids parking by acoustically and visually indicating distances to obstacles in front of and behind your Audi Q5	•	•	S	•	£270.83	£325.00
7X8	Audi parking system advanced. Aids parking by acoustically and visually indicating distances to obstacles with guiding lines. Measured by sensors and reversing camera. Only in combination with Technology package (WB7)	•	•	•	•	£283.33	£340.00
8X1	Headlight washers	•	S	S	S	£191.67	£230.00
4X4	Rear side airbags. Situated in side of rear seats	•	•	•	•	£212.50	£255.00

Options are subject to availability and may extend delivery.

- = Not available
 • = Available
 S = Standard

RRP – Recommended Retail Price.

VAT is calculated at 20% but this may alter to reflect any change in the applicable VAT rate.



Audi parking system advanced

Steering wheels

You can choose from a selection of advanced leather multi-function steering wheels, allowing you to control your audio system at the touch of a button.

Options are subject to availability and may extend delivery.

- = Not available
 ● = Available
 S = Standard

*The colours of the leather and stitching (where applicable) can be selected from any of the Audi exclusive colours shown on page 48.

RRP – Recommended Retail Price.

VAT is calculated at 20% but this may alter to reflect any change in the applicable VAT rate.

Order Code		SE	S line	S line Plus	SQ5	Basic RRP	Total RRP inc VAT
1XW	3-spoke multi-function steering wheel without gear-shift paddles. Manual models only	●	S	S	–	£87.50	£105.00
1XX	3-spoke multi-function steering wheel with gear-shift paddles. Automatic models only	●	S	S	S	£212.50	£255.00
2PF	3-spoke multi-function flat bottomed steering wheel. Manual models only	–	●	●	–	£83.33	£100.00
2PK	3-spoke multi-function flat bottomed steering wheel with gear-shift paddles. Automatic models only	–	●	●	●	£83.33	£100.00
6Q6	Audi aluminium gear knob (manual models only) Not available in combination with IE or VI	●	●	●	–	£104.17	£125.00
YRH S3G	Audi exclusive leather-covered steering wheel*	●	●	●	●	£400.00	£480.00
YRB S3G	Audi exclusive controls package.* Includes leather-covered steering wheel and gear-shift gaiter	●	●	●	●	£579.17	£695.00



Looking after your Audi

When you've chosen your ideal model, it's reassuring to know that it will remain in safe hands. That's why we've created products to protect your Audi, from extended warranties to Audi Complete – our comprehensive service and maintenance package. And there's also a range of Audi accessories and merchandise to choose from, enabling you to further enhance and safeguard your car.





Audi Complete

Audi Complete is simply a way to look after the servicing and maintenance costs for your Audi in a single package. You pay a one-off or monthly fee and we'll cover all your servicing, maintenance and tyres for the next three years, including your first MOT. It means you only have to pay for fuel, insurance and your Road Fund Licence. So you can be reassured that your car will be maintained by trained Audi Technicians, using genuine Audi parts. You can also opt for our Service only or Service and Maintenance packages if you prefer.

*Retail customers only. Pricing based on 3 years/30,000 miles (whichever occurs sooner). All pricing is a 'starting from' price for the Audi Q5 model range and is therefore subject to change and is mileage/model dependent.

Warranty

Options are subject to availability and may extend delivery.

-- = Not available
 • = Available
 S = Standard

**Only available prior to registration of your Audi Q5. Please contact your Audi Centre for full details.

RRP – Recommended Retail Price.

VAT is calculated at 20% but this may alter to reflect any change in the applicable VAT rate.

Order Code		Q5	SQ5	Basic RRP	Total RRP inc VAT
-	Audi Complete – Service only. Comprehensive care for your Audi covering all your servicing for 3 years. Visit your local Audi Centre for further information or audi.co.uk/audicomplete for full details including terms and conditions	•	–	£15.00	£18.00*
		–	•	£16.67	£20.00*
-	Audi Complete – Service and Maintenance. Comprehensive care for your Audi covering all your servicing and maintenance for 3 years, as well as your first MOT. Visit your local Audi Centre for further information or audi.co.uk/audicomplete for full details including terms and conditions	•	–	£21.67	£26.00*
		–	•	£22.50	£27.00*
-	Audi Complete – Service, Maintenance and Tyres. Comprehensive care for your Audi covering all your servicing, maintenance and tyres for 3 years, as well as your first MOT. Visit your local Audi Centre for further information or audi.co.uk/audicomplete for full details including terms and conditions	•	–	£34.17	£41.00*
		–	•	£45.00	£54.00*

Order Code		Q5	SQ5	Basic RRP	Total RRP inc VAT
-	Audi Warranty , covering you for unlimited mileage in the first 2 years of ownership, and up to 60,000 miles in the third year. Transferable between owners**	S	S	No charge	No charge
EA6	Audi Warranty , covering you for up to 4 years or 75,000 miles, whichever comes soonest. Cover includes a 2-year unlimited mileage warranty, and up to 75,000 miles in the third and fourth years. Transferable between owners**	•	•	£445.83	£535.00
EA9	Audi Warranty , covering you for up to 5 years or 90,000 miles, whichever comes soonest. Cover includes a 2-year unlimited mileage warranty, and up to 90,000 miles in the third, fourth and fifth years. Transferable between owners**	•	•	£1,045.83	£1,255.00

Accessories

Choosing an Audi isn't just a matter of deciding on the model you want; it's about creating a car that suits your needs perfectly. That's why we've developed a whole range of accessories to enhance your Audi Q5, enabling you to customise it down to the last detail. Like your Audi, all these accessories are developed to the highest possible standards. They're all available exclusively from Audi.

To find out more, just visit audi.co.uk/accessories or contact your local Audi Centre.

Warranty

All the accessories available on the Audi Q5 are covered by a three-year warranty,* if they are ordered and included in the purchase price of the car at date of delivery. Any accessories ordered and installed after delivery include a two-year warranty.*

*Excluding Road Angel products. Audi Accessories warranty terms and conditions can be found at audi.co.uk



Merchandise

From the enthusiasts' motorsport collection to the sophisticated Audi collection, there's a wide variety of adults' and children's clothing, lifestyle accessories and collectables, all of which bear the Audi name.

Please speak to a member of our team at your local Audi Centre to see the full Audi collection and to place an order. A selection of Audi merchandise is also available to buy from audi.co.uk/merchandise.



Audi Difference

The experts in Vorsprung durch Technik

Our Audi Approved Master Technicians have undergone an impressive 100,000 hours of training over a 10-year programme to ensure they have the latest technical expertise for maintaining and servicing your Audi. All our Service Advisors undergo a specialist induction and training to ensure they are Audi professionals and able to talk to you about any issues you may have with your Audi vehicle.

Servicing tailored to your needs

Regular servicing is key to safeguarding your Audi's performance and a full Audi service history could help you enhance the future re-sale value. To make servicing easy, the Audi Service Schedules have been designed to work with your individual driving style and vehicle.

We offer two different schedules: the fixed Inspection Service and the variable LongLife Service schedule. The conventional fixed Inspection Service schedule has fixed intervals for the Oil-change Service and Inspection Service, which are determined by time and distance.

With the variable LongLife Service schedule, the Inspection Service intervals are also fixed but the Oil-change Service intervals are variable. Sensors take account of driving style and conditions to determine when the Oil-change Service is required and the driver is informed via the on-board service interval display.

The choice of Service Schedule will depend on journey type and mileage as well as individual driving style and conditions. The table to the right can be used for guidance but your Audi Centre will help you to determine the most suitable Service schedule for you based on your individual circumstances and preferences.

Fixed Inspection Service Schedule

	Vehicle usage:
Mileage	Less than 10,000 miles per annum Mainly city/town centre driving. Short journeys.
	Service Intervals:
Oil-change Service	Fixed to every 9,000+ miles/1 year
Inspection Service	Fixed to every 19,000+ miles/2 years

Variable LongLife Service Schedule

	Vehicle usage:
Mileage	More than 10,000 miles per annum Motorway and main road driving. Mainly longer distance journeys. Constant speeds.
	Service Intervals:
Oil-change Service	Variable to a maximum of every 19,000+ miles/2 years
Inspection Service	Fixed to every 19,000+ miles/2 years

When a vehicle is frequently used in the following conditions, we recommend a Fixed Inspection Service Schedule, regardless of mileage:

Uneconomical driving styles, e.g. heavy acceleration and braking, constant use of high revs

High engine-loading conditions, e.g. frequent towing and hill climbs

*As indicated by the service interval display. Mileages are approximate as the Service Indicator system uses kilometres as its distance measurement.

Your convenience comes first

At Audi you can choose from a range of convenient services that suit your needs. Why not book a 'service while you wait' appointment* and enjoy our complimentary refreshments while your car is with us? Or, if you need to be mobile, take advantage of one of our courtesy cars which we can even deliver to you.* We guarantee we can service your Audi within 5 days without a courtesy car or within 10 days if you need transport. We will also ensure your car is returned to you with a full valet.

Audi Genuine Parts

You can rest assured that only Audi Genuine Parts will be used on your vehicle. What's more, Audi parts and labour come with a 2-year guarantee.**

No hidden costs

We believe strongly in transparency when it comes to our prices. For added peace of mind, we will give you a quotation over the phone for the work you have requested and email you the price confirmation. We'll consult you if any additional work on your car is needed when it is with us. We won't carry out any extra work without asking your permission first.

All part of the service

Whenever we see an Audi for a service, we connect it directly to our headquarters in Ingolstadt which enables us to check your car's software and make sure it's as up-to-date as possible. If the factory has released a software upgrade for your model, it can be applied immediately - improving anything from your car's efficiency to the precision of its parking system.

Audi Roadside Assistance

Your new car comes complete with 3 years' complimentary roadside assistance and recovery across the UK, provided by RAC Motoring Services. Also included is roadside assistance throughout Europe, managed by RAC Motoring Services.

For further information and terms and conditions please visit audi.co.uk.

* Subject to availability.

**Excludes wear and tear.



Off-road capabilities of the Audi Q5

The Audi Q5 excels both on the road and off it, thanks to its impressive all-terrain abilities. And these attributes are reinforced by special technologies, such as hill descent assist, ABS with automatic off-road detection and an Electronic Stability Programme that includes an off-road mode.

Hill descent assist

Available as standard in the Audi Q5, hill descent assist automatically maintains the speed set by the driver on steep descents and on any surface (up to 19mph). This makes negotiating descents far more straightforward and substantially enhances stability. Hill descent assist is activated and deactivated using a separate button.

ESP off-road mode

The Electronic Stability Programme in the Audi Q5 features a special off-road mode which can be controlled by a switch. This reprograms the ESP system, traction control and anti-lock braking system to adapt them to the driving conditions encountered in off-road terrain, such as sand, gravel or mud. This leads to good traction in all conditions, a more exciting drive and great handling even on unpredictable surfaces.

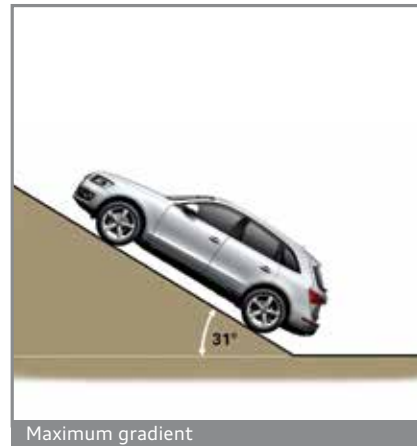
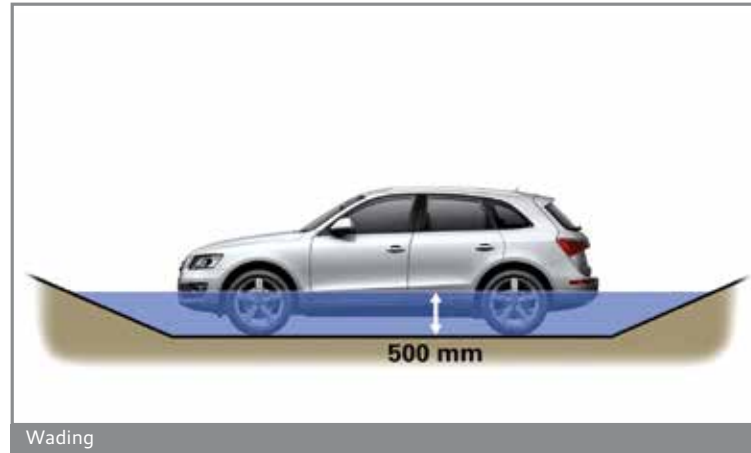

Off-road capabilities of the Audi SQ5

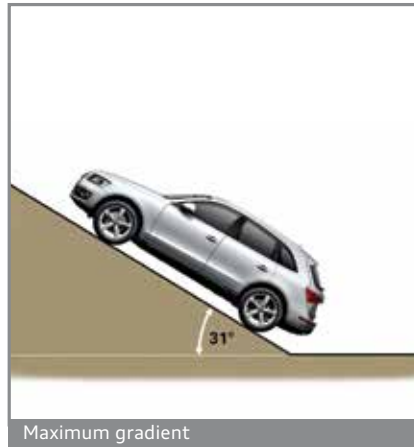
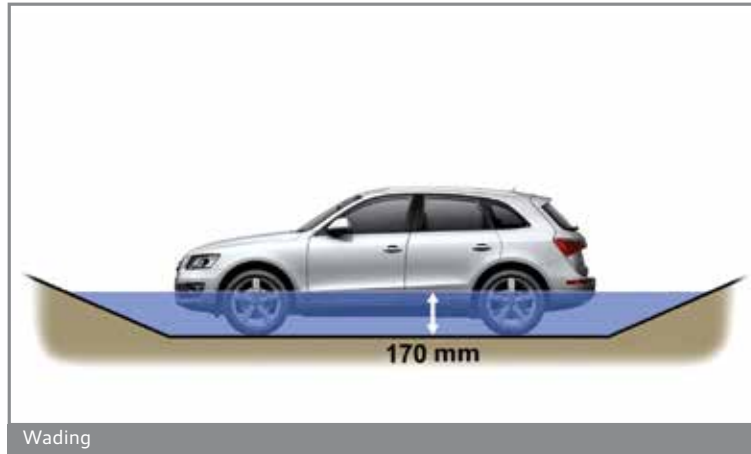

Audi Q5 technical data

Engine	Petrol			Diesel			
	2.0 TFSI quattro	2.0 TFSI quattro	2.0 TFSI quattro	2.0 TDI quattro	2.0 TDI quattro	2.0 TDI quattro	3.0 TDI quattro
Transmission	6-speed manual	6-speed manual	8-speed tiptronic	6-speed manual	6-speed manual	7-speed S tronic	7-speed S tronic
Cylinder	4-cylinder	4-cylinder	4-cylinder	4-cylinder	4-cylinder	4-cylinder	6-cylinder
Displacement, cubic cm (valves per cylinder)	1984 (4)	1984 (4)	1984 (4)	1968 (4)	1968 (4)	1968 (4)	2967 (4)
Max. power ¹ , PS at rpm	180/4000-6000	225/4500-6200	225/4500-6200	150/4200	177/4200	177/4200	245/4000-4500
Max. torque, Nm at rpm	320/1500-3800	350/1500-4500	350/1500-4500	320/1750-2500	380/1750-2500	380/1750-2500	580/1400-3250
Top speed, mph	130	138	138	118	127	124	140
0-62mph acceleration, seconds	8.5	7.4	7.1	10.8	9.0	9.0	6.5
CO ₂ emissions ² , g/km	174	174	184	154	154	159	169
Benefit in kind (BIK)% – April 13/14	26%	26%	28%	25%	25%	26%	28%
Fuel consumption ² , mpg (l/100km) Urban	30.4 (9.3)	30.4 (9.3)	29.4 (9.6)	41.5 (6.8)	41.5 (6.8)	41.5 (6.8)	39.8 (7.1)
Fuel consumption ² , mpg (l/100km) Extra Urban	44.1 (6.4)	44.1 (6.4)	40.9 (6.9)	52.3 (5.4)	52.3 (5.4)	50.4 (5.6)	47.1 (6.0)
Fuel consumption ² , mpg (l/100km) Combined	37.7 (7.5)	37.7 (7.5)	35.8 (7.9)	47.9 (5.9)	47.9 (5.9)	47.1 (6.0)	44.1 (6.4)
ABI insurance group 1-50*	24E	29E	30E	TBC	25E	25E	34E
Unladen weight ³ , kg	1720	1720	1755	1755	1755	1820	1860
Gross weight limit, kg	2330	2330	2365	2365	2365	2430	2470
Roof load limit/nose weight, kg	75/100	75/100	75/100	75/100	75/100	75/100	75/100
Max trailer load ⁴ unbraked, kg	750	750	750	750	750	750	750
Max trailer load ⁴ with 12% gradient, kg	2000	2000	2000	1800	2000	2000	2400
Max trailer load ⁴ with 8% gradient, kg	2200	2400	2400	2000	2400	2400	2400
Luggage compartment capacity, rear seats upright, litres	540	540	540	540	540	540	540
Luggage compartment capacity, rear seats folded, litres	1560	1560	1560	1560	1560	1560	1560
Fuel tank capacity approx, litres	75	75	75	75	75	75	75
Emission standard	EU6	EU6	EU6	EU5	EU5	EU5	EU5

*Highest insurance group rating shown. Group may be lower dependent on trim level. Please visit www.thatcham.org/abigroupratings for details.

¹The given value was obtained in accordance with the specified measurement procedure (the respective current version of the Directive 80/1269/EEC).

²Fuel consumption and CO₂ emissions figures are obtained under standardised test conditions (Directive 93/116/EEC) using a representative model. This allows direct comparison between different models from different manufacturers, but may not represent the actual fuel consumption achieved in 'real world' driving conditions. More information is available at www.vca.gov.uk.

³Vehicle's unladen weight without driver (calculated in accordance with the current version of Directive 80/1268/EEC). The fitting of additional equipment may increase the vehicle's unladen weight and drag coefficient, whereupon the potential carrying capacity and top speed will be correspondingly reduced.

⁴The engine's power output always goes down with increasing altitude. At 1,000m above sea level, and for every additional 1,000m, deduct 10% from the weight of the outfit (trailer load limit + gross weight of the towing vehicle).

Audi SQ5 technical data

	Diesel
Engine	3.0 BiTDI quattro
Transmission	8-speed tiptronic
Cylinder	6-cylinder
Displacement, cubic cm (valves per cylinder)	2967 (4)
Max. power ¹ , PS at rpm	313/3900-4500
Max. torque, Nm at rpm	650/1450-2800
Top speed, mph	155*
0-62mph acceleration, seconds	5.1
CO ₂ emissions ² , g/km	179
Benefit in kind (BIK)% – April 13/14	30%
Fuel consumption ² , mpg (l/100km) Urban	37.2 (7.6)
Fuel consumption ² , mpg (l/100km) Extra Urban	44.1 (6.4)
Fuel consumption ² , mpg (l/100km) Combined	41.5 (6.8)
ABI insurance group 1-50**	41E
Unladen weight ³ , kg	1920
Gross weight limit, kg	2530
Roof load limit/nose weight, kg	75/100
Max trailer load ⁴ unbraked, kg	750
Max trailer load ⁴ with 12% gradient, kg	2400
Max trailer load ⁴ with 8% gradient, kg	2400
Luggage compartment capacity, rear seats upright, litres	540
Luggage compartment capacity, rear seats folded, litres	1560
Fuel tank capacity approx, litres	75
Emission standard	EU5

*Electronically Limited

**Highest insurance group rating shown. Group may be lower dependent on trim level. Please visit www.thatcham.org/abigroupratings for details.

¹The given value was obtained in accordance with the specified measurement procedure (the respective current version of the Directive 80/1269/EEC).

²Fuel consumption and CO₂ emissions figures are obtained under standardised test conditions (Directive 93/116/EEC) using a representative model. This allows direct comparison between different models from different manufacturers, but may not represent the actual fuel consumption achieved in 'real world' driving conditions. More information is available at www.vca.gov.uk.

³Vehicle's unladen weight without driver (calculated in accordance with the current version of Directive 80/1268/EEC). The fitting of additional equipment may increase the vehicle's unladen weight and drag coefficient, whereupon the potential carrying capacity and top speed will be correspondingly reduced.

⁴The engine's power output always goes down with increasing altitude. At 1,000m above sea level, and for every additional 1,000m, deduct 10% from the weight of the outfit (trailer load limit + gross weight of the towing vehicle).



Audi Q5 dimensions

The technical drawings opposite show the exact dimensions of the Audi Q5, so you can check everything – from whether the car will fit in your garage to whether your luggage will fit in the boot.

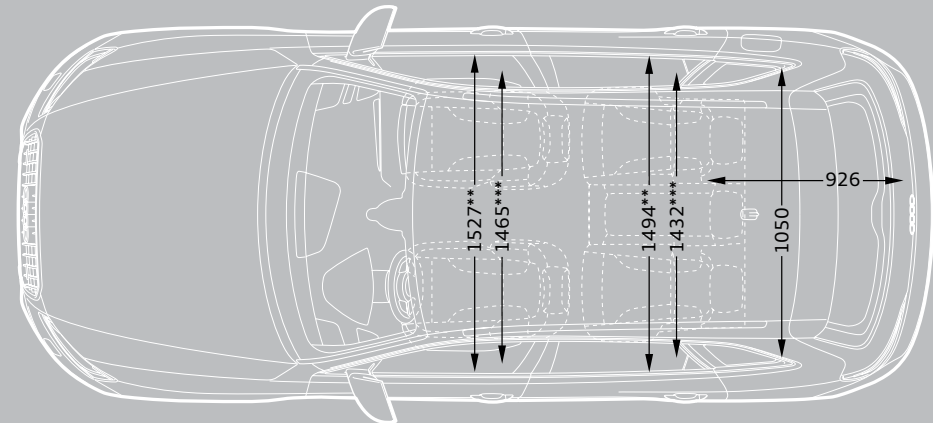
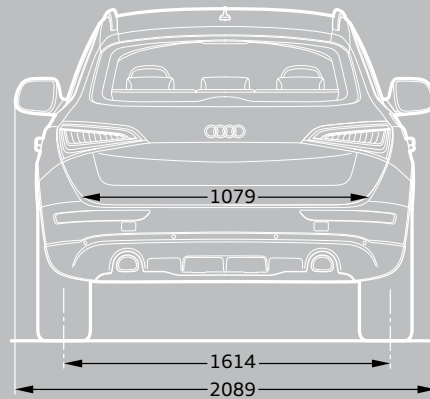
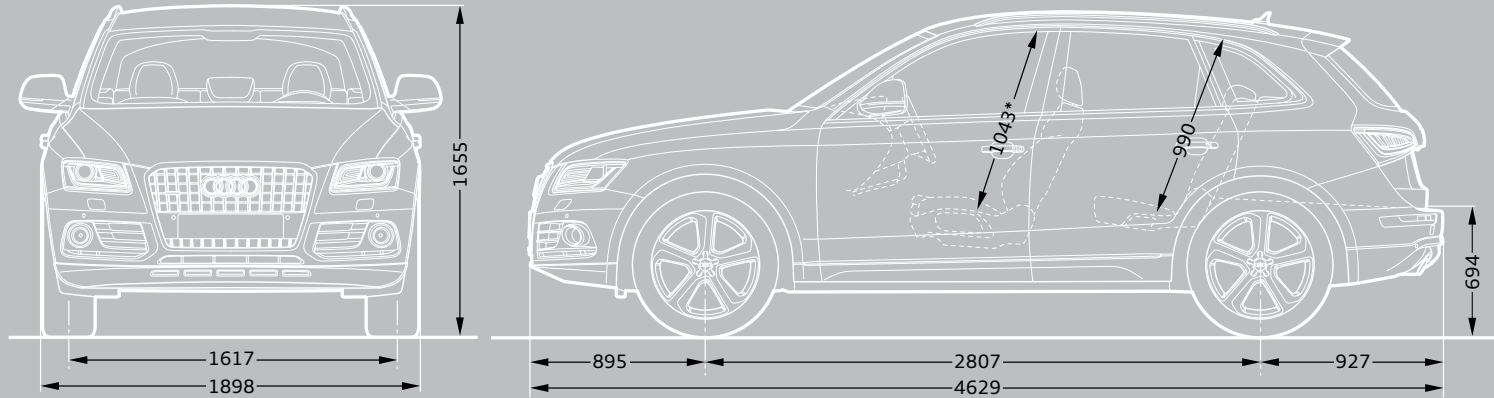

Dimensions measured with vehicle at unladen weight.

Turning circle approx 11.7m.

Dimensions in millimetres.

*Maximum headroom.

**Elbow width room.

***Shoulder width room.

Audi SQ5 dimensions

The technical drawings opposite show the exact dimensions of the Audi SQ5, so you can check everything – from whether the car will fit in your garage to whether your luggage will fit in the boot.

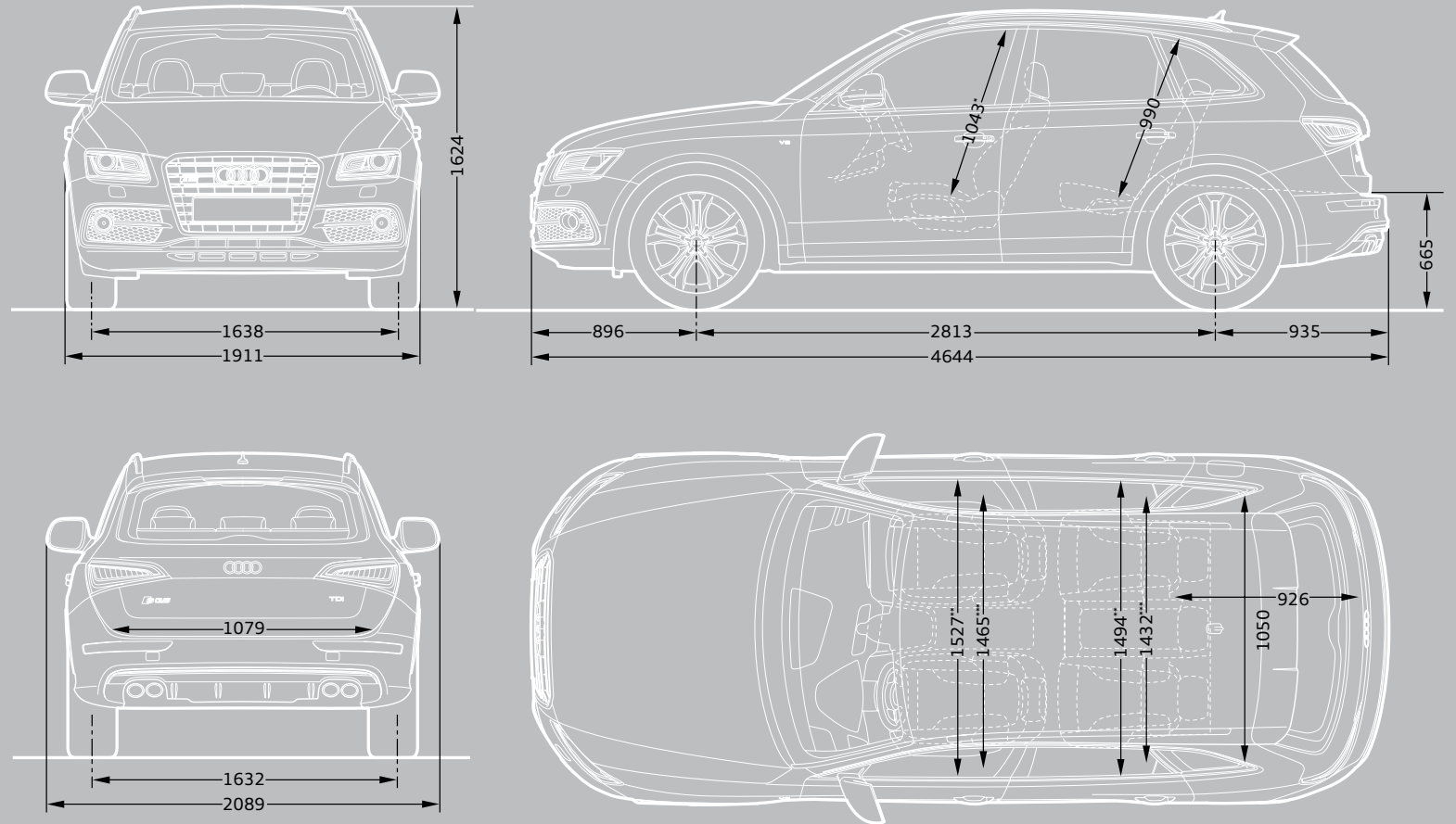

Dimensions measured with vehicle at unladen weight.

Turning circle approx 11.7m.

Dimensions in millimetres.

*Maximum headroom.

**Elbow width room.

***Shoulder width room.

Pricing and Additional information

Welcome to Audi

By placing an order for your Audi, you're choosing to get behind the wheel of one of the most sophisticated cars on the road. And because we believe the service we offer should be just as advanced, we want to let you know exactly what you can expect from us, now and in the future.

We've agreed a set of standards with all our Centres which governs the way we do business with you. It outlines the kind of service we promise to deliver for every customer, right down to filling each new Audi we sell with half a tank of fuel.

So whether you're interested in the date your car will arrive in the UK or the way we'll dispose of non-biodegradable materials after we service your Audi, you can have total confidence in us.

Audi Promise

Audi Centres

We guarantee that all our Centres will be open as follows:

Sales: Monday to Friday 9am–6pm
Saturday 9am–5pm

Service: Monday to Friday 8am–6pm
Saturday 8.30am–1pm

Sunday opening is at local discretion.

New car delivery

Once we've confirmed a delivery date for your car, we'll keep you informed of progress. Subject to reasonable notice, we'll then deliver it to a place of your choice, whether that's your home or work. In the unlikely event of a delay, we'll provide a courtesy car to minimise inconvenience and keep you mobile.

Environmental commitment

We promise to dispose of all non-biodegradable materials from your vehicle in a responsible manner.

Pricing

Prices and specifications given are correct at the time of printing. Always check details with your Audi Centre as Audi policies are continually developing. We reserve the right to change prices or specifications at any time.

All prices are subject to VAT, currently charged at 20%, but this may alter to reflect any change in the applicable VAT rate.

Delivery charges and number plates are not included in the vehicle price.

Delivery charge	£471.66
Number plate	£20.00
VAT	£98.34
Total	£590.00

Audi Customer Care

Every new Audi benefits from the comprehensive Audi Customer Care Package, which comprises:

- ▶ A 3-year Audi warranty, which covers you for unlimited mileage in the first 2 years of ownership, with a full mechanical and electrical warranty which covers you for up to 60,000 miles in the 3rd year
- ▶ A 3-year paint warranty
- ▶ A 12-year anti-corrosion warranty
- ▶ 3 years' UK roadside assistance and recovery

You also have the option when ordering your new car of choosing a 4-year or 5-year Audi warranty. Speak to a member of the sales team for more information.

Audi tax-free sales

If you are entitled to purchase a vehicle free of VAT, normally through military or diplomatic privilege, please contact your local Audi Centre for full details.

Should you have any difficulty obtaining the information you require, please call Freephone 0800 585878.

Audi Finance

Audi Finance specialises in providing funding solutions for Audi drivers. Whether your Audi is for private or business use, there is a range of funding options to choose from.

Below is the full range of finance products, which comprises:

- ▶ Solutions – a Personal Contract Plan
- ▶ Hire purchase
- ▶ Lease purchase
- ▶ Finance lease
- ▶ Contract hire

With all products, you can choose a fixed-cost maintenance plan designed to help you budget accurately.

No matter which Audi model you choose, your local Audi Centre can provide you with a personalised quote designed to fit your budget and motoring needs.

Audi Finance is a trading name of Volkswagen Financial Services (UK) Limited. An offer of finance depends on certain conditions. Available to people over 18 in the UK only.

Audi Insurance

We want you to start enjoying your new car from day one and thanks to Audi Insurance complimentary 7-day cover, you can. Call free on 0800 316 7893 (lines are open Monday to Friday 8am–9pm, and Saturday 9am–5pm), provide a few details and a cover note will be sent to your Audi Centre. They will then tax your car and you can drive it away.

Additional information

CO₂ data and information

CO₂ emissions-based Vehicle Excise Duty

Vehicle Excise Duty (Road Fund Licence) is based upon the amount of Carbon Dioxide (CO₂) a vehicle emits, measured in grams per kilometre (g/km). First year VED rates apply to the first year of ownership. Annual VED rates apply thereafter. The DVLA has created thirteen categories:

Petrol and Diesel engines	First year	Annual rate (second year onwards)
A – up to 100g/km	£0.00	£0.00
B – 101 to 110g/km	£0.00	£20.00
C – 111 to 120g/km	£0.00	£30.00
D – 121 to 130g/km	£0.00	£105.00
E – 131 to 140g/km	£125.00	£125.00
F – 141 to 150g/km	£140.00	£140.00
G – 151 to 165g/km	£175.00	£175.00
H – 166 to 175g/km	£285.00	£200.00
I – 176 to 185g/km	£335.00	£220.00
J – 186 to 200g/km	£475.00	£260.00
K – 201 to 225g/km	£620.00	£280.00
L – 226 to 255g/km	£840.00	£475.00
M – over 255g/km	£1,065.00	£490.00

Vehicle Excise Duty (VED) rates correct at time of going to print, but these may alter to reflect any change in the applicable VED rate.







Audi UK

Customer Services
Selectapost 29
Sheffield
S97 3FG
0800 699888
audi.co.uk

Specifications and prices subject
to change without notice.

© Audi UK

Printed in the UK
Edition 4.0 05/13
2014 model year

Images are for illustrative purposes only.

