



**The new Audi RS Q3**

Pricing and Specification Guide  
Valid from August 2013



# Personalising your Audi RS Q3

This guide has been designed to help you tailor and price your Audi RS Q3 quickly and logically. At the back, you will find information on CO2 emissions-based taxation and the other services offered by Audi, including Finance and Insurance. You can also configure your Audi RS Q3 online at [audi.co.uk](http://audi.co.uk).

## The Audi RS Q3

Engine	12
Transmission	13
Technology	14

## Model details and prices

Standard model equipment	18
Model prices	22

<b>Audi exclusive</b>	24
-----------------------	----

## Colour and upholstery

Paint	26
Upholstery	30
Colour and trim guide and seats	34

<b>Inlays</b>	36
---------------	----

## Options

Wheels and tyres	40
Packages	44
Audio and communication	46
Interior equipment	48
Exterior equipment	50
Safety and security	52

## Looking after your Audi

Warranty	56
Merchandise	57
Audi Difference	58

## Technical details

Technical data	59
Dimensions	60
Pricing and Additional information	61





## Vorsprung durch Technik

Three words that express the very essence of Audi. Vorsprung durch Technik isn't a slogan. It's our way of seeing the world. It is the driving force behind our history of innovation that continues into the 21st century. Indeed, many technologies that Audi pioneered remain in our cars today. Some are milestones in the history of the motorcar.

From our beginnings in 1899, to the Auto Union team's Grand Prix successes in the 1930s and our more recent wins at Le Mans, we have always been at the forefront of the motor industry.

Vorsprung durch Technik makes us who we are. To see more of its influence, just read on.





## Introducing the RS Q3

Audi RS models stand for superior driving dynamics and athletic design. As sporty, progressive high-performance vehicles with a clear focus on performance, they enhance the brand essence of *Vorsprung durch Technik*.

The Audi RS Q3 combines typical Audi characteristics such as sportiness, progressiveness and sophistication with the hallmark performance of an RS model and the practical benefits of a compact SUV: as the RS all-rounder, it is the exclusive high-performance vehicle for leisure, business and family. It thus opens up a new dimension within the RS model portfolio. Eye-catching features such as the inline 5-cylinder TFSI engine developing 310PS, its acceleration from 0-62mph in 5.5 seconds and visual highlights such as the RS front bumper with funnel-shaped air intake and quattro logo evoke the unmistakable character of the RS Q3.











## **RS Q3 interior story**

We've introduced a number of finishing touches to the Audi RS Q3 interior to make your driving experience unique. You'll find an impressive attention to detail in everything from the luxurious Fine Nappa leather to our optional diamond-patterned stitching, which means that every journey you make will be a personal one.

# Engine

## Petrol

The 2.5 litre engines of the Audi RS Q3 delivers genuine high-performance. With a displacement of 2,480 cc, it produces 310PS of power and provides 420Nm of torque in the 1,500-5,200 rpm range. This provides superior power delivery at low revolutions on the one hand and enormous sprinting ability up to a maximum speed of 155 mph\* on the other.

The extraordinary 5-cylinder core design lends the Audi RS Q3 an unmistakable sound range by virtue of the ignition sequence. It also provides the advantages of compact dimensions and low weight. Naturally, all of the parts in this engine are engineered to meet the demanding requirements for use in the Audi RS Q3.



# Transmission

## **S tronic®**

Driving is all about thinking ahead, which is just what the S tronic® dual-clutch transmission does. It works almost as two separate systems, one engaging the odd-numbered and the other the even-numbered gears. So when you're accelerating in second, it has third gear waiting for you. And once you make the switch, it's already thinking about fourth. With two clutches working together, you can change gears almost instantly while experiencing smooth, uninterrupted power.



## Technology

### **quattro® permanent all-wheel drive**

Like every RS model, the Audi RS Q3 comes with quattro® permanent all-wheel drive as standard. It's the technology that has given us the edge on the rally circuit ever since it was first introduced over 30 years ago, bringing victory for the Audi quattro on its very first outing. It's called quattro® permanent all-wheel-drive. In this system, four permanently driven wheels deliver better acceleration, road-holding and safety, while asymmetric dynamic torque distribution intelligently controls the flow of power to the front and rear axles

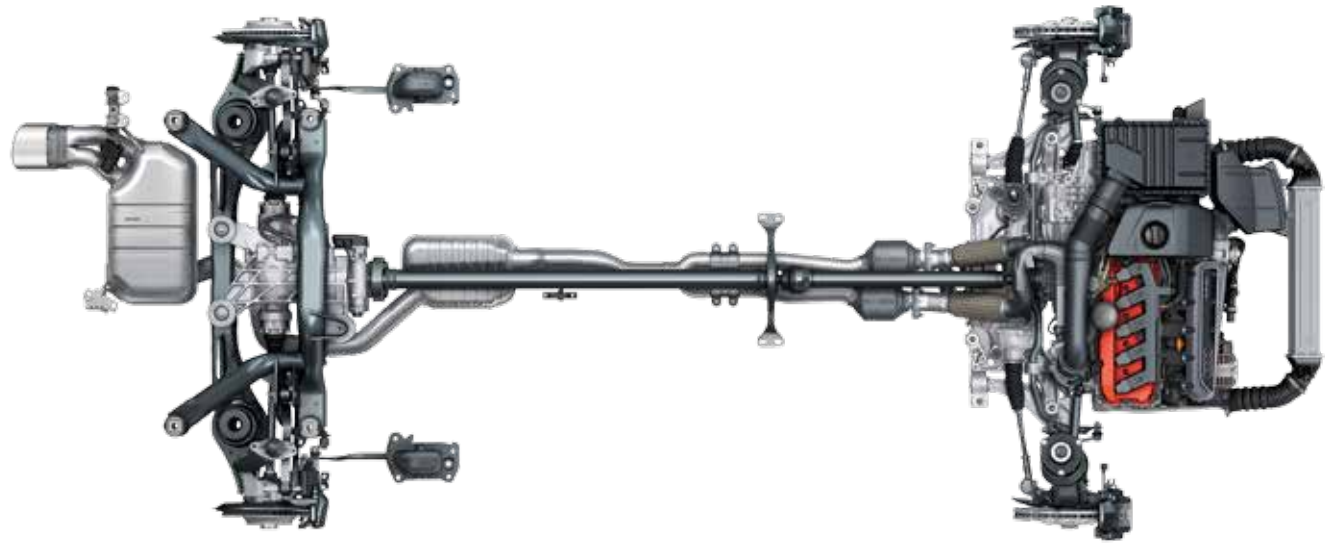



## High-performance braking system

A car as powerful as an RS needs an equally powerful system to slow it down. This takes the form of 18-inch RS brakes, with 8-piston fixed callipers on the front axle. Each brake disc is internally ventilated and perforated for enhanced performance, while a special 'floating' friction ring improves stability under high temperature loads.

## Audi Drive Select

With the standard Audi drive select®, you can influence individual vehicle components at the push of a button and so change the character of your Audi RS Q3. Generally speaking, the accelerator pedal characteristic curve, exhaust flap control and the steering torque of the electromechanical power steering can be configured. You have 3 modes available to adapt these components to the individual driving situation. Auto mode is the setting that defines the superior sporty self-assurance of the Audi RS Q3. Comfort mode is particularly suitable for longer distances, whereas dynamic mode is designed for ambitious driving.







# Standard model equipment

## All RS Q3 models have the following items of standard equipment

The RS range incorporates some of our most exclusive, dynamic and sporty models. But in the unmistakable RS Q3, you will find not only the high performance and sophistication you'd expect, but also a surprising level of functionality that makes this a great car for everyday use.

### Engine and transmission

**Efficiency program in the Driver's Information System (DIS)** – provides the driver with fuel-saving tips and a gear-change indicator

**Recuperation** – increasing the generator voltage converts kinetic energy into usable electric power when the vehicle is coasting or braking. This recuperated (brake) energy is then used to assist the generator during subsequent acceleration, saving up to 3% fuel

**Start-stop system** helps to reduce fuel consumption and CO<sub>2</sub> emissions by switching off the engine in stationary phases e.g. at traffic lights. The start process is initiated as soon as the foot brake is released when moving off again. Can be deactivated via a button at any time

### Wheels, tyres and suspension

**20" x 8.5J '5-twin-spoke-V' design alloy wheels** with 255/35 R20 tyres

#### Anti-theft wheel bolts

**Audi drive select** – changes vehicle characteristics by adapting power steering assistance, accelerator characteristics and exhaust flap control. The system also influences the cornering light function of the optional adaptive lights (if fitted). Modes available: comfort, auto and dynamic

**Electromechanical parking brake** – includes parking brake function when the car is stationary, auto-release function to assist when pulling away and emergency braking function on all four wheels

**RS brake system** 18-inch diagonally-split high-performance brake system, Antilock Brake System (ABS) with Electronic Brake Force Distribution (EBD), Electronic Stabilisation Control (ESC), hydraulic brake assist, adapted brake booster function; wave brake discs at front in composite design, ventilated and perforated, ventilated brake discs at rear; brake calipers painted in high-gloss black, front calipers feature RS emblem

**RS sports suspension** with dynamically tuned spring/damper combination; McPherson spring strut-type axle at the front with lower wishbones and aluminium subframe; four-link rear axle with separate spring/damper arrangement, subframe

#### Tyre mobility kit



20" x 8.5J '5-twin-spoke-V' design alloy wheels



RS brake system



Audi Music Interface

## Audio and communication

**6.5" display screen** – manually retractable

**Audi Music Interface (AMI)** – provides connection to Apple iPod from 4th generation and Apple iPhone, as well as USB storage media and MP3 players

**Audi sound system** with 10 speakers including centre speaker in the dashboard and subwoofer beneath the luggage compartment floor. Total output of 180 Watts and 6-channel amplifier

**Bluetooth interface** – for handsfree mobile phone connectivity and Bluetooth audio streaming (depending on compatibility of mobile phone)

**Colour Driver's Information System (DIS)** – with high-resolution 3.5" TFT colour display in the dashboard binnacle. The DIS shows the radio frequency/station or track title, telephone control menu and other display information from the infotainment system such as navigation (if fitted). Also includes an on-board trip computer with short and long-term trip memory, outside temperature display, digital speedometer, door or boot open warning and efficiency program; RS menu with display of charging pressure, oil temperature and lap timer

**Concert radio** which includes:

- 50-station memory with dynamic station list, FM (VHF) and AM (MW) reception
- Single CD drive and two SDHC memory card readers (up to 32GB) which are MP3, WMA and AAC compatible
- MMI operating logic
- Speed-dependent volume control (GALA)
- TP memo function whilst driving

**Preparation for SD card based navigation system** – allows maps to be retro-fitted using parts from Audi Genuine Accessories

**Voice control system** – for key telephone and radio functions

## Interior equipment

**Aluminium-look pedals**

**Black cloth headlining**

**Cup holders** – 2, integrated into the centre console

**Door sill trims** with aluminium insert and RS Q3 logo

**Dual-zone electronic climate control** with sunlight-dependent control, electronically controls the air temperature, flow rate distribution, separate temperature distribution for driver and front-passenger side, automatic air recirculation control using an air quality sensor, combined filter, air vents in the rear centre console, ventilated glove compartment, separate defroster button for rapid defrosting of the windscreen and side windows, key-coded settings, includes a light/rain/humidity sensor

**Electric windows**, front and rear with safety system to limit maximum closing force and convenience opening / closing via remote control key

**Flat-bottomed RS Q3 3-spoke perforated leather-trimmed multi function steering wheel** with contrast stitching in rock grey and aluminium-look gear shift paddles

**Front and rear floor mats** in black velour

**Front centre armrest** which can be moved forwards/backwards with adjustable angle. Also includes folding storage compartment and a 12-Volt socket in the rear centre console

**Inlays in Aluminium Race design** in the dashboard, door trims and centre console and features additional aluminium-look elements on the dashboard and door trims

**Instrument cluster** with grey dials, red needles and white scales, RS logo in the rev counter; automatic ready-check; with adjustable lighting, electronic speedometer with odometer and trip odometer, rev counter, digital clock, coolant temperature display and fuel gauge

**Interior lighting** front and rear, with delayed switch-off and contact switches on all doors; luggage compartment and glove compartment lighting

**Luggage compartment sill protection** in stainless steel

**Reversible luggage compartment floor** – one side in high-quality velour, the other with a waterproof, hard-wearing plastic surface. Also includes additional storage compartments under the floor

**RS selector lever knob** in perforated leather, with RS emblem and trim ring in aluminium-look; selector lever gaiter in leather with decorative stitching in rock grey

**Smoking package** – includes ashtray with removable aluminium-look lid with Audi rings and a cigarette lighter in the centre console (non-smoking package is available at no charge)

**Steering wheel adjustable** for height and reach

**Washer fluid level indicator**



Aluminium-look pedals



Door sill trims with aluminium insert and RS Q3 logo



Flat-bottomed RS Q3 3-spoke perforated leather-trimmed multi function steering wheel\*

\* Image shown also includes optional Inlays in Carbon which is available at additional cost

# Standard model equipment

continued

## Seats

**Heated front seats**, heats seat and backrest centre panels as well as seat side bolsters; individually adjustable in several stages for driver and front passenger

**Front Sports seats** with shaped seat side bolsters for better lateral support. Also includes manual adjustment of seat height, fore/aft position, seat angle, head-restraint height and seat belt height plus electric 4-way lumbar support and extendable thigh support

**ISOFIX child seat mounting** for front passenger (with airbag deactivation) and outer rear seats including electric child-proof locks for the rear doors and window controls; operated via the child-proof lock buttons in the drivers door armrest

**Seats upholstered in black Fine Nappa leather** with embossed RS Q3 logo in the front seat backrests and contrast Rock grey stitching

**Split folding rear seat back**

## Exterior equipment

**Door mirrors with matt aluminium-look housing** electrically adjustable and heated with integrated LED indicator signals

**Flat, Metallic or Pearl effect paint**

**Full body colour paint finish** to the front and rear underbody guard, wheel arch trims and lower door trims

**Headlight washers**

**Heated windscreen washer jets**

**Matt aluminium styling package which includes:**

- Radiator grille frame, window trims and roof rails in matt aluminium-look
- Funnel-shaped air intake frame, upper edge of rear diffuser insert and RS roof spoiler in body colour
- Radiator grille, quattro logo, side air intake funnels, B-pillar window trim and triangular panels on the rear doors in high-gloss black

**RS design body styling** which includes:

- Audi Single frame radiator grille with honeycomb-design grid in high-gloss black with RS logo and one-piece trim frame in matt aluminium-look

- RS bumpers in a sporty dynamic design; at the front with large air inlets and side flaps in high-gloss black as well as body-coloured funnel-shaped air intake with quattro logo and at the rear with diffuser in high-gloss black

- RS design rear roof spoiler on the luggage compartment lid, painted in body colour

- RS Q3 model name of the luggage compartment lid

**RS exhaust system** with large, chrome-plated, oval tailpipe on the left

**Tow bar bracket preparation** - includes the wiring to the spare wheel well and control unit and adapted engine cooling. The set of parts for retrofitting are available from Audi Genuine Accessories

**Windscreen with sunband** for improved insulation of the windscreen and acoustic glass for reduced outside noise

**Xenon plus headlights** with automatic/dynamic headlight range control and LED daytime running lights strip. Also includes rear lights, brake lights and rear turn signals all featuring LED technology



Front sports in black Fine Nappa leather with contrasting stitching in rock grey\*



RS design body styling and Xenon plus headlight

\*Image shown also includes optional electric front seats and under-seat storage contained in the Storage package, both of which are available at additional cost.

### Safety and security

**Airbags:** Full size airbags for the driver and front passenger; in conjunction with ISOFIX child seat mounting for the front-passenger seat including deactivation switch for the front-passenger airbag

- Front side airbags integrated into the seat backrests
- Head airbag system: deploys over the side windows to protect the front and outer rear seat passengers in the event of a side impact

**Antilock Brake System (ABS)** with Electronic Brake Force Distribution (EBD) and hydraulic brake assist

**Anti-Slip Regulation (ASR)** reduces spinning of the drive wheels by reducing engine power and delivers more traction and stability on the road surface

**Audi parking system plus.** Acoustic and visual parking aid for the front and rear of the vehicle with on-screen display of distance remaining from obstacles using a graphical representation. Measurement is by ultrasonic sensors integrated discreetly into the bumpers

### Electronic Differential Lock (EDL)

– On surfaces with varying levels of grip, this start-off assistant automatically brakes the drive wheels on surfaces that are too slippery, thereby ensuring smooth, powerful progress

**Electronic Stabilisation Control (ESC)** with sport mode, can be activated in two stages; networks to the ABS, EBD, ASR and EDL with its own sensors and compares the driving data with reference data; provides better stability by targeted braking of individual wheels and intervention in the engine management system

**First aid kit** located in the right-hand side trim of the luggage compartment

**Light and rain sensor** – automatically switches the dipped beam headlights and windscreen wipers on/off depending on the light and rain conditions. Also includes coming home/leaving home function which delays the deactivation of the front and rear lights after locking and automatic activation of the lights when unlocking

### Rear fog lights

**Remote central locking with two foldaway keys** – includes convenience closing and opening of the windows; with RS emblem

**Seat belt reminder** for all seats; an acoustic and visual warning signal reminds the passenger in the front seat to fasten their seat belts, a visual warning signal indicates when seat belts have been undone in the rear

**Thatcham Category 1 alarm and immobiliser**

**Tool kit and car jack**

**Warning triangle**



RS exhaust system



Xenon plus headlight

## RS Q3

Engine	Power	Transmission	CO <sub>2</sub> g/km	Basic RRP	Total RRP inc VAT	Recommended OTR
2.5 TFSI quattro	310PS	7-speed S tronic	206	£34,779.17	£41,735.00	£43,000.00

**Please note:** The maximum power output figures are quoted in PS (or Pferdestärke, which is the metric equivalent of brake horsepower). To convert to brake horsepower, divide the PS figure by 1.0139.

**Recommended On-The-Road (OTR) retail prices include:** delivery charge, half a tank of fuel, number plates at £590.00 (inc. VAT), Road Fund Licence (which may vary depending on model/transmission; see page 60 for details) and first registration fee at £55.00. Vehicle Excise Duty correct at time of going to print, but this may alter to reflect any change in the applicable VED rate.

RRP – Recommended Retail Price. VAT is calculated at 20% but this may alter to reflect any change in the applicable VAT rate.

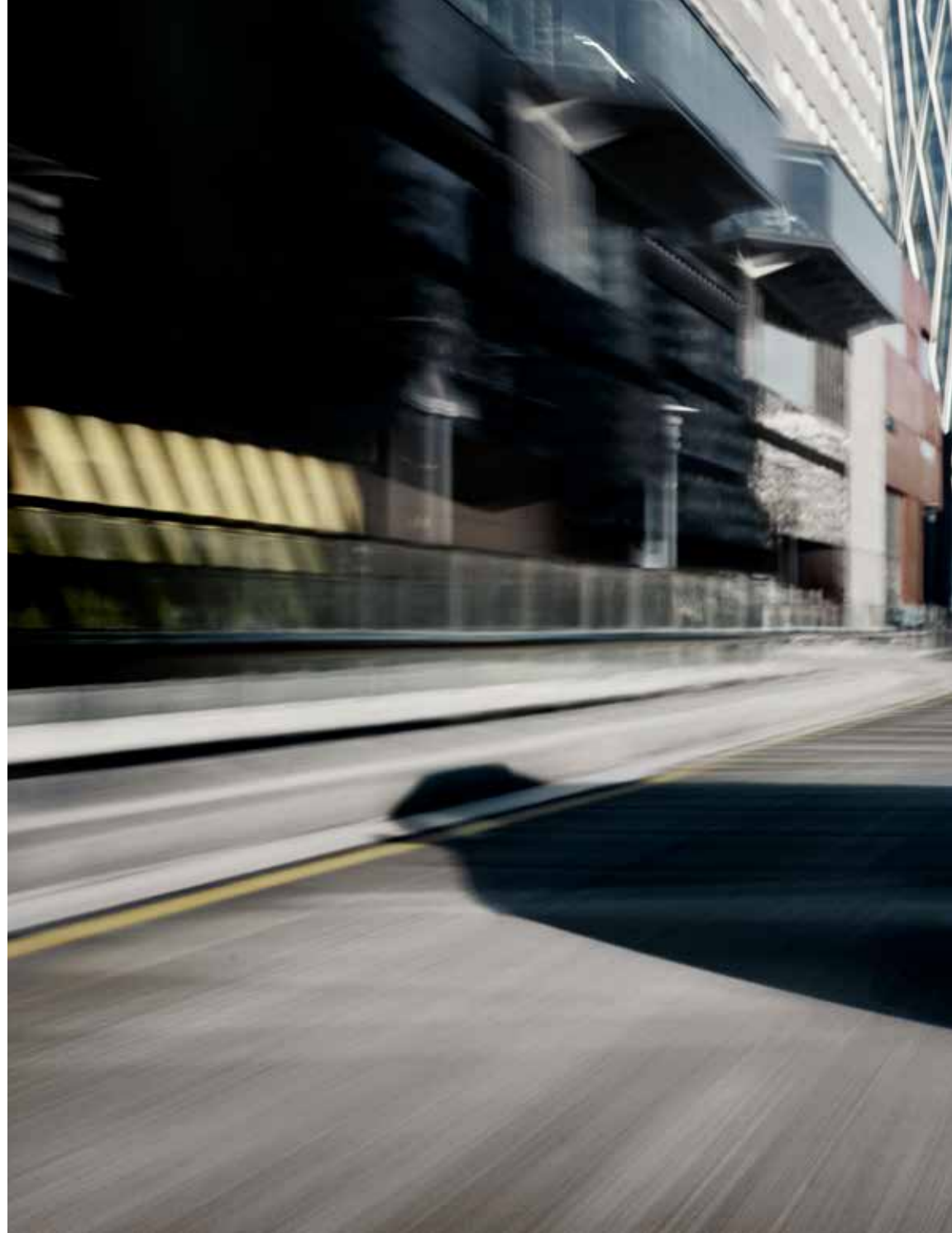







## Audi exclusive

Every Audi is intrinsically exclusive. It's the breathtaking design, the exceptional engineering, the Vorsprung durch Technik. But for that special touch you can specify your new RS Q3 with options from Audi exclusive. Whether you want a unique, custom-mixed paint colour or seats in a combination of complementary shades, Audi exclusive will enable you to drive the car you've always imagined.

Both the exclusive and standard options can be found on the following pages.



# Paint

We believe that every part of your car should have a personal touch. Which is why you can choose from a wide range of paint colours and finishes, from standard shades to metallic and pearl effects. We can even mix a customised colour for you to create the perfect fit.

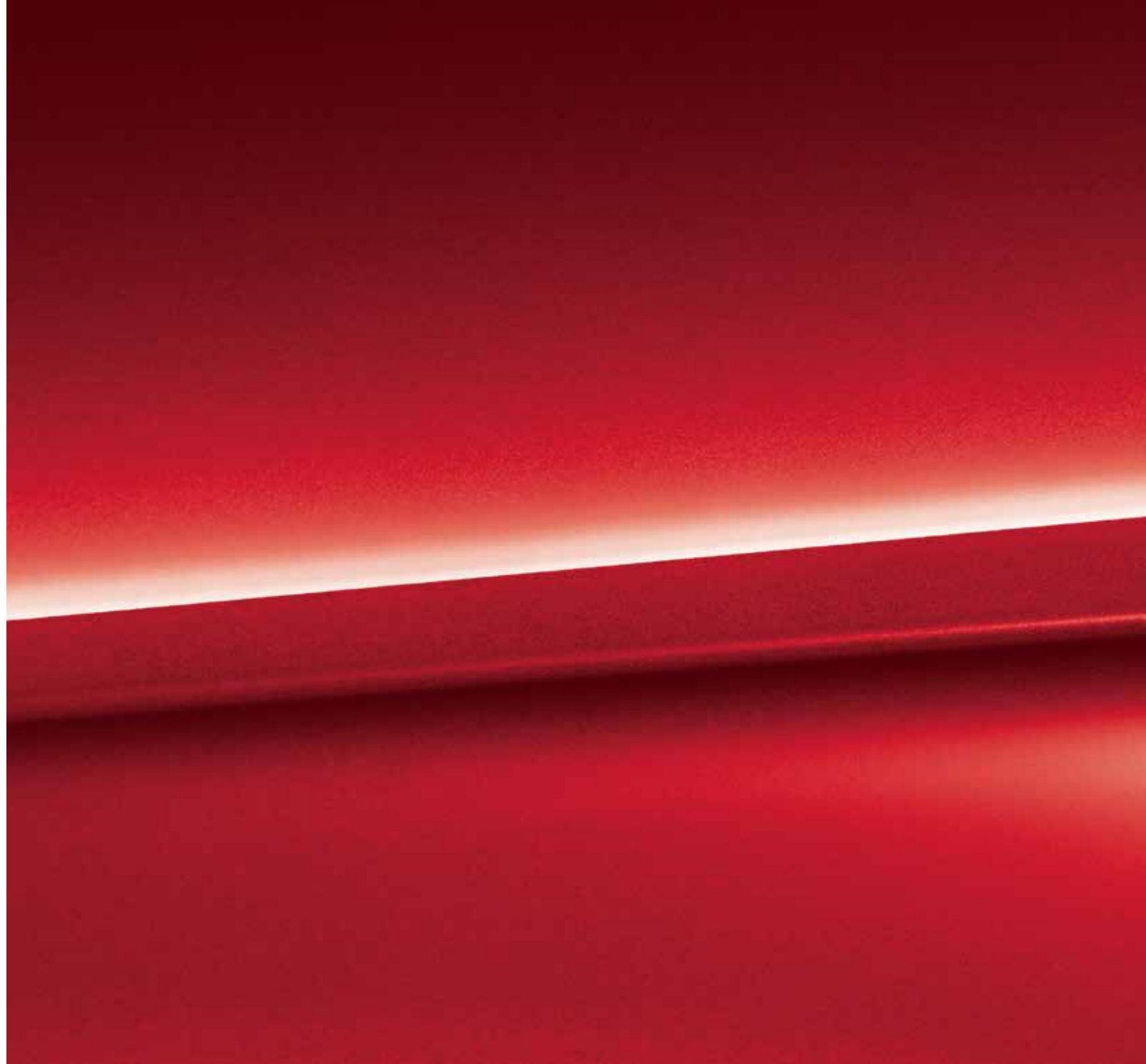

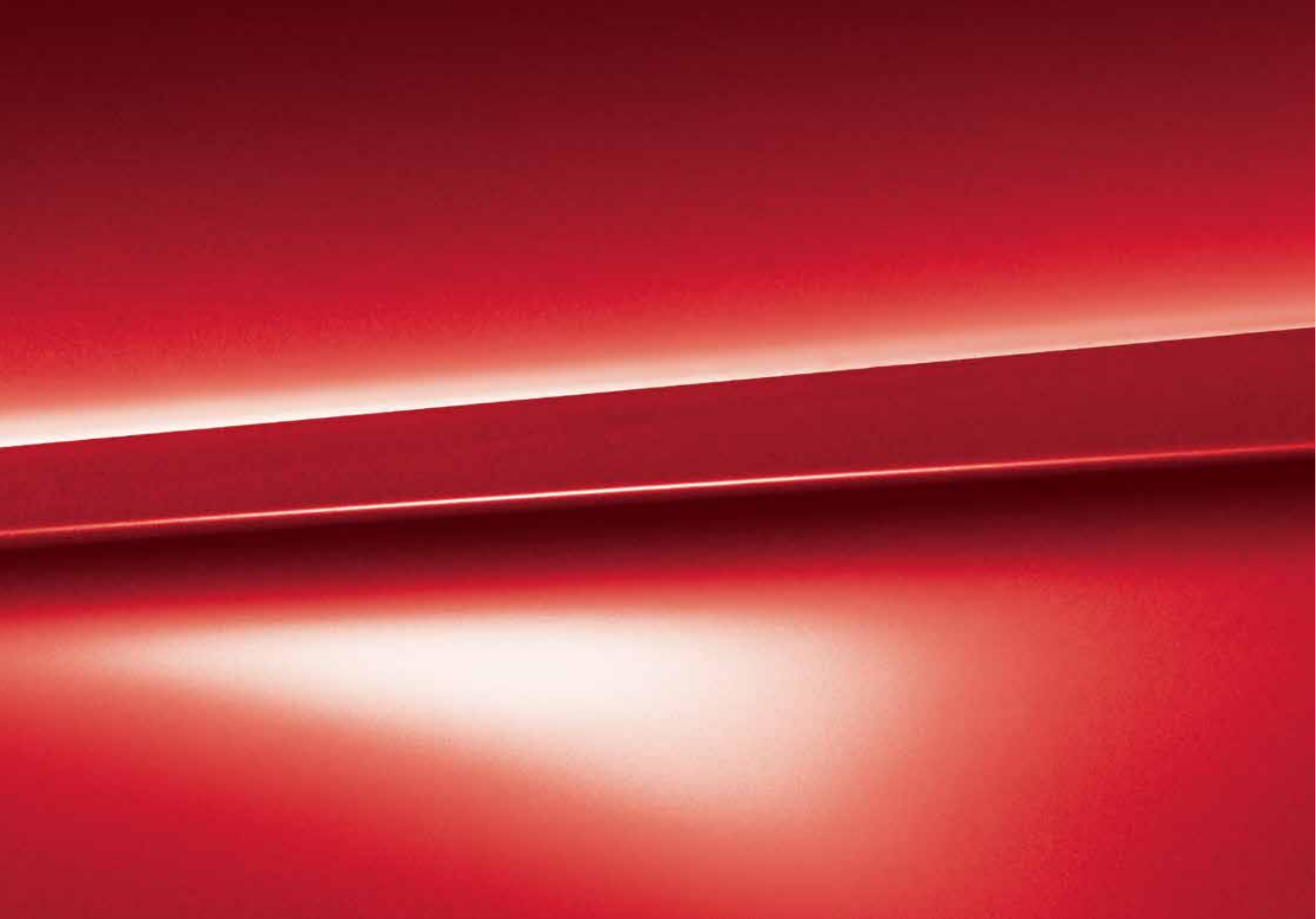

# Paint

You can select the standard colours shown opposite or, for a different look, choose from a range of optional finishes.

## Standard colours



Amalfi white - Y5

## Optional colours

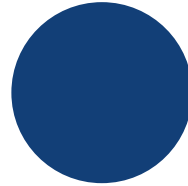

Sepang blue, pearl effect - E9

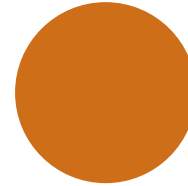

Samoa orange, metallic - J0

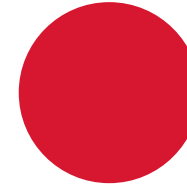

Misano red, pearl effect - N9

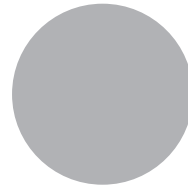

Ice silver, metallic - P5



Glacier white, metallic - 2Y

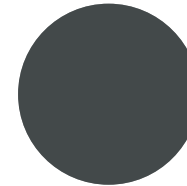

Daytona grey, pearl effect - 6Y

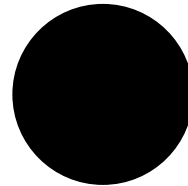

Phantom black, pearl effect - L8

Options are subject to availability and may extend delivery.

All the colour swatches on this page are matched as accurately as possible to the actual paint colours used. However, due to print processes, Audi UK cannot guarantee that colours shown are 100% accurate.

Visit your local Audi Centre for a more accurate colour swatch.

RRP - Recommended Retail Price.

VAT is calculated at 20% but this may alter to reflect any change in the applicable VAT rate.

### Optional colours

**Basic RRP**

No charge

**Total RRP inc VAT**

No charge

# Paint

## Audi exclusive

Everyone has a favourite colour. No matter what yours is, Audi exclusive provides a range of unique colours that have been designed to set your car apart. Choose from the swatches here, or specify any other paint colour in the Audi range. Whether it's Sepang blue from the Audi R8 or Alpine white from the original Audi quattro, the choice is yours.

## Customised paint

If you have a particular colour in mind, we'll mix the exact metallic or pearl-effect shade you want.\*

\*Customised paint is subject to factory approval, and is available for metallic and pearl-effect water-based paints only. Three-colour process colours and two-tone schemes are not available.

\*\*Visit your local Audi Centre for colour samples.

All the colour swatches on this page are matched as accurately as possible to the actual paint colours used. However, due to print processes, Audi UK cannot guarantee that colours shown are 100% accurate.

Visit your local Audi Centre for a more accurate colour swatch.

RRP - Recommended Retail Price.

VAT is calculated at 20% but this may alter to reflect any change in the applicable VAT rate.

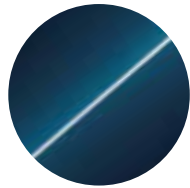

Palace blue, pearl effect

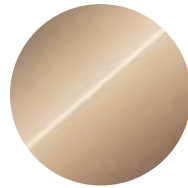

Sand beige, pearl effect

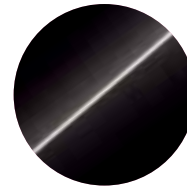

Saddle brown, pearl effect

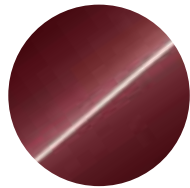

Classic red, pearl effect

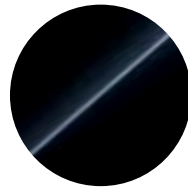

Mamba black, metallic

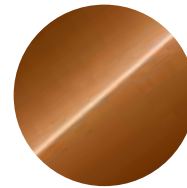

Ipanema brown, metallic



Any colour in the Audi range or 100 exclusive colours to choose from\*\*



Customised paint

### Audi exclusive

**Basic RRP**  
£1,687.50

**Total RRP inc VAT**  
£2,025.00

### Customised\*

**Basic RRP**  
£2,104.17

**Total RRP inc VAT**  
£2,525.00

## Upholstery

It's important to feel comfortable on the road. Just choose from our range of luxury upholstery materials and textures, including additional heating and colour options, for complete relaxation while you drive.









# Upholstery

## RS embossed front Sports seats

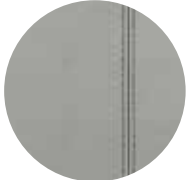
Choose your favourite upholstery from the swatches shown opposite to give your car's interior the look and feel you want.

		RS Q3	Basic RRP	Total RRP inc VAT
Alcantara/leather (N7S)		●	No charge	No charge
	Black - FZ			
Fine Nappa leather (N1T)		S	No charge	No charge
	Black with stitching in rock grey - <b>UB</b>			
				
	Lunar grey with stitching in rock grey - <b>QO</b>			
Fine Nappa leather with diamond-patterned stitching (N1H)		●	£662.50	£795.00
	Black with diamond-pattern stitching in rock grey - <b>UB</b>			

Options are subject to availability and may extend delivery.

- = Not available
- = Available
- S = Standard

RRP - Recommended Retail Price.

VAT is calculated at 20% but this may alter to reflect any change in the applicable VAT rate.





# Colour and trim guide

## Interior trim colours

### RS Q3 embossed front Sports seats

Use this guide to help you choose the right interior for your Audi RS Q3. It shows the carpet, dashboard and headlining colours that have been matched to your chosen upholstery.

\*Headlining in Lunar silver cloth (6N) can be ordered as an alternative for all interior versions – see page 48.

Order code	Upholstery	Carpet	Dashboard (upper/lower)	Headlining	Alcantara/Leather (N7S)	Fine Nappa leather (N1T)	Fine Nappa leather with diamond-patterned stitching (N1H)
<b>QH</b>	Black	Black	Black/Black	Black*	●	—	—
<b>UB</b>	Black with Rock grey stitching	Black	Black/Black	Black*	—	●	●
<b>QO</b>	Lunar silver with Rock grey stitching	Black	Black/Black	Black*	—	●	—

## Seats

Choose from a variety of different seat options so you can maintain the right driving comfort at all times.

Order Code		RS Q3	Basic RRP	Total RRP inc VAT
<b>PV1</b>	<b>Electric front seats.</b> Includes adjustment for height, forwards and backwards position and backrest angle	●	£475.00	£570.00
<b>3NU</b>	<b>Through-load facility.</b> For safely transporting long objects, including rear centre armrest with cup holders and storage compartment	●	£145.83	£175.00
<b>3X2</b>	<b>Ski/snowboard bag.</b> A practical way of safely transporting long objects. Only in combination with Through-load facility	●	£58.33	£70.00

Options are subject to availability and may extend delivery.

— = Not available  
● = Available  
S = Standard

RRP – Recommended Retail Price.

VAT is calculated at 20% but this may alter to reflect any change in the applicable VAT rate.

# Seats

Options are subject to availability and may extend delivery.

- = Not available
- = Available
- S = Standard

\*Image shown also includes optional electric front seats and under-seat storage contained in the Storage package, both of which are available an additional cost

RRP - Recommended Retail Price.

VAT is calculated at 20% but this may alter to reflect any change in the applicable VAT rate.



Front sports seat in Black Fine Nappa leather with rock grey stitching\*

## Inlays

Attention to detail can make a big impact. From contemporary black Piano finish to matt-brushed aluminium, our selection of inlays make the perfect finishing touch to your car's interior.





# Inlays

Inlays are the all-important finishing touch that add flair and interest to your car's interior. Choose from the range of sleek inlays shown opposite.

Order Code		RS Q3	Basic RRP	Total RRP inc VAT
<b>5TL</b>	<b>Piano finish, black</b> in the dashboard, door trims and centre console and features addition aluminium-look elements on the dashboard and door trims	●	No charge	No charge
<b>5MD</b>	<b>Aluminium race</b> in the dashboard, door trims and centre console and features addition aluminium-look elements on the dashboard and door trims	S	No Charge	No charge
<b>5MB</b>	<b>Carbon</b> in the dashboard, door trims and centre console and features addition aluminium-look elements on the dashboard and door trims	●	£208.33	£250.00

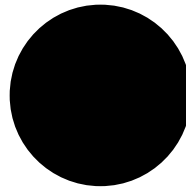

Piano finish, black – 5TL

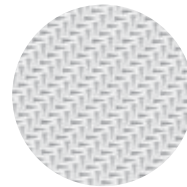

Aluminium race – 5MD



Carbon – 5MB

Options are subject to availability and may extend delivery.

- = Not available
- = Available
- S = Standard

RRP – Recommended Retail Price.

VAT is calculated at 20% but this may alter to reflect any change in the applicable VAT rate.



## Options

Every driver has different needs, which is why we have created some useful options to further enhance your car. For extra comfort, support, style or function, you can choose from a variety of additional features, tailoring everything from your infotainment and audio equipment to your wheels and lighting.







# Wheels and tyres

Choose a set of specially-selected alloy wheels to subtly enhance the way your car looks and drives.

Order Code		RS Q3	Basic RRP	Total RRP inc VAT
CF6	20" x 8.5J '5-twin-spoke-V' design alloy wheels with 255/35 R20 tyres	S	No charge	No charge
C15	20" x 8.5J '5-arm Rotor' design matt titanium finish alloy wheels with 255/35 R20 tyres	•	£162.50	£195.00
F13	20" x 8.5J '5-arm Rotor' design matt black finish alloy wheels with 255/35 R20 tyres	•	£162.50	£195.00
7K6	Tyre pressure monitoring system – a visual and acoustic warning when the system detects a loss of pressure in an individual tyre	•	£70.83	£85.00



20" x 8.5J '5-twin-spoke-V' design alloy wheels – CF6



20" x 8.5J '5-arm Rotor' design matt titanium finish alloy wheels – C15



20" x 8.5J '5-arm Rotor' design matt black finish alloy wheels – F13

Options are subject to availability and may extend delivery.

- = Not available
- = Available
- S = Standard

RRP – Recommended Retail Price.

VAT is calculated at 20% but this may alter to reflect any change in the applicable VAT rate.



# Packages

Order Code	RS Q3	Basic RRP	Total RRP inc VAT
<b>WB4</b> <b>Technology package</b> - HDD-based MMI Satellite Navigation Plus which includes the following: navigation data saved on hard disk drive, high-resolution 7" colour display screen with high-quality map view. Map with topographical shading and many points of interest and city models shown in 3D. A choice of three alternative routes can be selected where possible. Includes a rotary button with integrated joystick function for searching in the map. Route information is displayed on a split screen (route instructions, points of interest along motorways, TMC traffic reports en route). Detailed intersection map and lane recommendations. Dynamic route guidance using TMC traffic information. Navigation address can be input using the voice control system. Route arrow instructions displayed in colour in the Driver's Information System. Includes full European map data and 7-digit postcode recognition. Also includes a hard disk drive jukebox function which can be used to store up to 20GB of music (MP3, WMA, AAC and MPEG4 compatible) and a DVD drive for playing music and video DVDs (when the car is stationary). The MMI Satellite Navigation Plus can be operated via the MMI controls, multi-function steering wheel or voice control system	●	£1,245.83	£1,495.00
<b>PAR</b> <b>Extended matt aluminium styling package.</b> In addition to the Matt aluminium styling package which comes as standard, the funnel-shaped air intake frame, the quattro logo, the side air intake funnels, the upper edge of the rear diffuser insert and side fins of the RS roof spoiler are also in matt aluminium-look	●	£83.33	£100.00
<b>PAH 5J4</b> <b>Audi exclusive high-gloss black package</b> which includes: - Radiator grille frame, radiator grille, quattro logo, side air intake funnels and window frames in high-gloss black - Funnel-shaped air intake frame, upper edge of rear diffuser insert and RS roof spoiler in body colour - Roof rails in matt black Only in combination with body coloured door mirror housing (6FA)	●	£83.33	£100.00



Extended matt aluminium styling package



Audi exclusive high-gloss black package



Image shows Extended matt aluminium styling package, featured wheels are not available in the UK.

# Audio and communication

Stay in touch using our range of communication functions, and give each journey its own soundtrack with our advanced audio equipment.

Order Code		RS Q3	Basic RRP	Total RRP inc VAT
9VK	<b>BOSE® surround sound.</b> Surround sound reproduction with 14 loud speakers including a centre speaker in the dashboard and a subwoofer under the luggage compartment floor, 10-channel amplifier with a total output of 465 watts, powerful and accurate bass reproduction, lifelike sound with natural tone and a feeling of space for an outstanding sound experience; sound system perfectly matched to the interior acoustics of the vehicle. A particular design highlight is the floating effect of the front loudspeakers, created by indirect lighting in LED technology, AudioPilot® for noise-dependant volume adjustment. Reproduction of 5.1 Surround Sound is possible in conjunction with Technology package (WB4). Only in combination with LED interior light package (QQ1)	●	£575.00	£690.00
PNU	<b>Satellite Navigation system</b> – SD card based. Route planning and guidance using voice, pictogram and 2D mapping shown on the 6.5" colour display screen. Can be operated via the MMI controls, multi-function steering wheel or voice control system. Includes European map data and 7-digit postcode recognition	●	£412.50	£495.00
7A2	<b>CD changer</b> in the glove compartment, for 6 CD's (MP3 and WMA capable), shock-resistant, each CD can be loaded and changed individually. Music files with digital rights management (DRM) cannot be displayed	●	£270.83	£325.00
QU7	<b>Digital TV reception.</b> Receives digital (DVB-T) uncoded television stations (MPEG-2 standard), TV picture, teletext and Electronic Programme Guide (EPG). Facility to connect external AV sources via adaptor cable (available from Audi Genuine Accessories). Please note – TV reception depends on local digital network availability. No AV or TV video output when driving (audio output available). Only in combination with Technology package (WB4)	●	£725.00	£870.00

Options are subject to availability and may extend delivery.

- = Not available
- = Available
- S = Standard

RRP – Recommended Retail Price.

VAT is calculated at 20% but this may alter to reflect any change in the applicable VAT rate.

# Audio and communication

Stay in touch using our range of communication functions, and give each journey its own soundtrack with our advanced audio equipment.

Order Code		RS Q3	Basic RRP	Total RRP inc VAT
9ZF	<b>Mobile telephone preparation – Low with Bluetooth.</b> Provides handsfree connection via Bluetooth and includes an external aerial connection and charging facility for optimal mobile phone reception. To use the external aerial and charging facility an optional cradle will be required at extra cost – please contact your Audi Centre for phone compatibility	●	£145.83	£175.00
9ZW	<b>Mobile telephone preparation – High with Audi connect.</b> Audi connect provides access to a number of innovative online services via an internal UMTS (3G) module. Audi connect online services include: navigation using Google Earth images and Google Street View, destination entry via Google Maps or myAudi, online point of interest search and information services such as weather forecasts and the latest world news. Audi connect also includes Audi traffic information online, which gives accurate real-time forecasts of the traffic situation along the chosen route. The traffic situation can be displayed on the navigation map or Google Earth image. Audi connect can also create a Wi-Fi hotspot in the car for convenient internet access using a mobile device (e.g. laptop or tablet). Many Audi connect features can be simply operated via MMI Navigation Plus, the multi-function steering wheel or the voice control system. Only in combination with Technology package (WB4).  Important connectivity information: An external data source is required to enable the Audi connect online services. One of the two following external data sources can be used 1. A mobile telephone with Bluetooth SIM Access Profile 2. A separate SIM card which can be inserted in the included SIM card reader. When a separate SIM card is used, hands free phone calls are possible using the SIM card or by connecting a different mobile telephone via Bluetooth Hands Free Profile	●	£291.67	£350.00

Options are subject to availability and may extend delivery.

<sup>1</sup>Online services are only available for mobile phone contracts or SIM cards which include a data option and only within the coverage of the mobile phone network; there may be additional costs for the use of these services (charges and billing correspond to the personal mobile phone contract or SIM card contract). Due to high data volumes, a mobile phone contract including an unlimited or high usage data plan is strongly recommended. The content and scope of the online based services offered may vary.

<sup>2</sup>To check the compatibility of your mobile phone and whether it has SIM Access Profile compatibility, please visit [www.audi.co.uk/owners-area/phone-compatibility.html](http://www.audi.co.uk/owners-area/phone-compatibility.html)

– = Not available  
● = Available  
S = Standard

RRP – Recommended Retail Price.

VAT is calculated at 20% but this may alter to reflect any change in the applicable VAT rate.

# Interior equipment

Specify every detail of your car's interior with this range of exclusive options.

Order Code		RS Q3	Basic RRP	Total RRP inc VAT
4L6	<b>Auto-dimming rear view mirror</b> recognises with the aid of a light sensor when the headlights behind are too bright and dims the mirror automatically	●	£245.83	£295.00
6SJ	<b>Reversible luggage compartment mat.</b> Velour on one side, rubber on the other, which folds out to cover the luggage compartment floor, the sill/bumper and the backs of the rear seats when folded down.	●	£62.50	£75.00
6NJ	<b>Cloth headlining</b> in Lunar silver	●	No charge	No charge
QE1	<b>Storage package.</b> Comprising storage nets on front-seat backrests, storage compartments under both front seats, lockable glovebox and multi purpose hook in front passenger footwell	●	£83.33	£100.00
QE4	<b>Luggage compartment package.</b> Includes a stretch combi-net for fixing down objects into luggage compartment, a 12V socket, a movable side net and a second luggage compartment light on the left	●	£70.83	£85.00
QQ1	<b>LED interior light package.</b> Glare-free illumination of the interior thanks to energy-saving, durable LED technology. Consists of: - Interior lights, front and rear, including reading lights - Illuminated vanity mirror for driver and front passenger - Illuminated cup holders - Illuminated storage compartment in the centre console - Entrance and footwell lighting as well as i) inside door handles - Reflected lighting for centre console and inside door handles - Illuminated vents - Active door reflectors (with bulbs) Also, includes LED lighting around the front speakers when BOSE Surround Sound (9VD) is ordered	●	£204.17	£245.00
9JA	<b>Non-smoking package.</b> Replaces ashtray and cigarette lighter with 12V socket and a centre storage compartment	●	No charge	No charge

Options are subject to availability and may extend delivery.

- = Not available
- = Available
- S = Standard

RRP – Recommended Retail Price.

VAT is calculated at 20% but this may alter to reflect any change in the applicable VAT rate.





# Exterior equipment

Make sure your car looks exactly as you want it to, by selecting some of our striking options.

Options are subject to availability and may extend delivery.

- = Not available
- = Available
- S = Standard

RRP – Recommended Retail Price.

VAT is calculated at 20% but this may alter to reflect any change in the applicable VAT rate.

Order Code		RS Q3	Basic RRP	Total RRP inc VAT
3FU	<b>Panoramic glass sunroof.</b> Two-piece tinted glass insert, the front glass element with electric slide-and-tilt control and electric sunblind for front and rear passengers. Automatic close function from outside via the remote central locking. Provides added light and improved air extraction. Only in combination with LED interior lighting package (QQ1)	•	£916.67	£1,100.00
4F2	<b>Advanced key.</b> Access and authorisation system which automatically exchanges data between key and vehicle, allowing the driver to keep the key in their pocket or bag at all times. To unlock and open, simply lift the exterior door handle. To lock, press the button on the handle. Also includes an ignition start/stop button integrated in the centre console to start and stop the engine	•	£354.17	£425.00
4KF	<b>Privacy Glass.</b> Dark tinted rear and rear-side windows from B-pillar backwards	•	£300.00	£360.00
3S2	<b>Black roof rails</b>	•	No charge	No charge
1D4	<b>Towing equipment – ball rod and ball coupling.</b> The ball coupling swings out mechanically and is operated manually via a Bowden cable. Includes an indicator lamp on the Bowden cable and a display in the instrument cluster for checking if the tow bar has locked into place correctly. Also includes a trailer stabilisation programme in the Electronic Stability Programme (ESP)	•	£520.83	£625.00
6FA	<b>Body coloured door mirrors</b>	•	£104.17	£125.00
6XE	<b>Door mirrors – electrically adjustable, folding and heated.</b> Also includes an automatic kerb view dipping function when reverse gear is selected	•	£125.00	£150.00
6XK	<b>Door mirrors – auto-dimming on the driver’s side, electrically adjustable, folding and heated.</b> Must be combined with auto-dimming rear-view mirror (4L6). Also includes an automatic kerb view dipping function on the passenger side when reverse gear is selected	•	£208.33	£250.00



Panoramic glass sunroof



Panoramic glass sunroof



# Safety and security

Intelligent technology designed to give you better all-round awareness and safety on the road.

Options are subject to availability and may extend delivery.

- = Not available
- = Available
- S = Standard

RRP – Recommended Retail Price.

VAT is calculated at 20% but this may alter to reflect any change in the applicable VAT rate.

Order Code		RS Q3	Basic RRP	Total RRP inc VAT
7X8	<b>Audi parking system advanced with rear reversing camera.</b> Acoustic and visual parking aid for front and rear, image of area behind the vehicle shown on the MMI display, with dynamic display modes showing the calculated path (steer-angle dependent), including help lines and guidelines for parking in bays and identification of point at which to apply opposite lock when parallel parking, reversing camera integrated discreetly in the handle strip of the luggage compartment lid	•	£541.67	£650.00
8T2	<b>Cruise control.</b> Maintains any speed above 18mph, provided that the engine power output and engine braking effect permit it; operated via separate steering column stalk, set speed is displayed in the Driver's Information System (DIS)	•	£187.50	£225.00
8Q5	<b>Adaptive headlights.</b> The dynamic cornering light infers the course of the road from the movement of the steering wheel and variably illuminates the bend by swivelling the Xenon headlights; operational between speeds of approximately 6mph and 68mph	•	£245.83	£295.00
8N7	<b>High-beam assist.</b> Working within system limits, it automatically detects the headlights of oncoming traffic, the rear lights of other road users and built up areas. Depending on the traffic situation, the high beam is automatically switched on or off. The system thereby improves the driver's visibility and safety and ensures a more relaxed drive thanks to extra comfort and convenience. Only in combination with Auto dimming rear view mirror (4L6)	•	£83.33	£100.00
4X4	<b>Rear side airbags.</b> Situated in the side of the rear seats	•	£250.00	£300.00

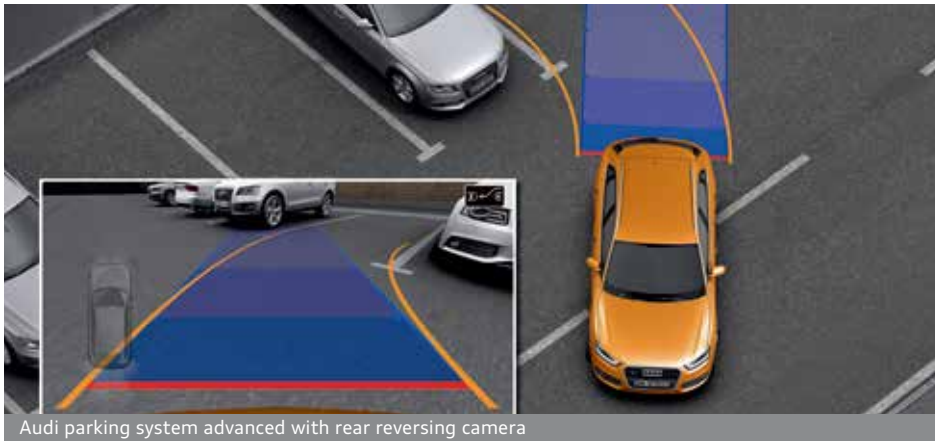

# Safety and security

Intelligent technology designed to give you better all-round awareness and safety on the road.

Options are subject to availability and may extend delivery.

- = Not available
- = Available
- S = Standard

RRP - Recommended Retail Price.

VAT is calculated at 20% but this may alter to reflect any change in the applicable VAT rate.

Order Code		RS Q3	Basic RRP	Total RRP inc VAT
UH2	<b>Audi hill-hold assist.</b> Once the vehicle comes to a stop, Audi hill-hold assist uses either the ESP system or the electromechanical parking brake to hold the vehicle stationary for an unlimited amount of time, thus preventing it from rolling away on uphill or downhill gradients	•	£75.00	£90.00
UG5	<b>Hill descent control.</b> Speed control by means of brake intervention and engine drag torque, whilst constantly maintaining speed depending on surface. The driver just has to steer, but does not have to accelerate or brake	•	£162.50	£195.00
7Y1	<b>Audi side assist.</b> Aids the driver when changing lane. Audi side assist monitors the area behind your car using radar sensors located discreetly in the rear bumper. It then informs the driver with a visual warning signal in the door mirror if there is a vehicle in their blind spot or approaching quickly from behind. The system is activated using a button in the driver's door	•	£375.00	£450.00
7Y4	<b>Audi active lane assist.</b> Lane markings are registered by an optical sensor in the windscreen from speeds of approximately 40mph or above. Camera identifies individual or coloured lane markings, e.g. yellow lines at roadworks. The lane departure warning system warns the driver if a detected lane marking is approached without indicating, and helps the driver to steer back towards the middle of the lane by making gentle steering movements. Steering wheel vibration can be activated as an additional warning when crossing lane markings. System is activated manually by a switch on the turn signal lever. Only available in combination with high beam assist (8N7) and auto-dimming rear-view mirror (4L6). When ordered with Technology package, speed limit display is included as a no cost option	•	£375.00	£450.00
QR9	<b>Speed limit display.</b> Camera-based recognition and display of speed limits, including temporary speed limit displays (e.g. above motorways). Additionally, working within system limits, there is an evaluation of the particular situation in wet conditions, for speed limits that vary depending on time of day, for roadworks and when using a trailer. If a sign has not been recognised by the camera, thanks to Audi Connect (9ZW) (if fitted) the speed limit taken from the navigation data (where available) can be displayed. Only available as a no cost option when Technology package and Audi active lane assist are ordered together	•	No charge	No charge

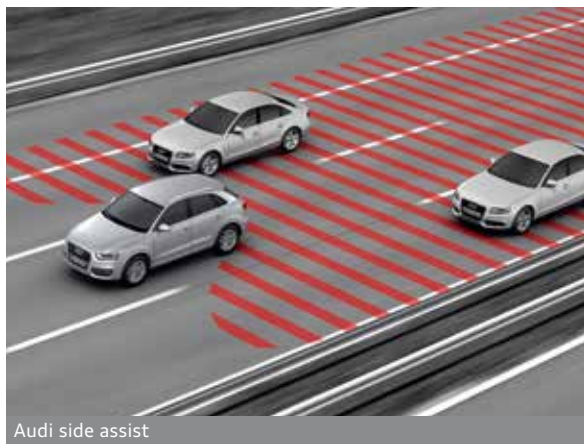

Audi side assist

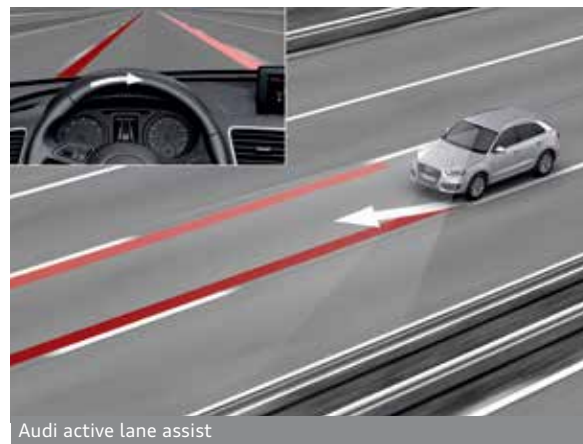

Audi active lane assist



Speed limit display

## Looking after your Audi

When you've chosen your ideal model, it's reassuring to know that it will remain in safe hands. That's why we've created products to protect your Audi, from extended warranties to Audi Complete – our comprehensive service and maintenance package. And there's also a range of Audi accessories and merchandise to choose from, enabling you to further enhance and safeguard your car.





# Warranty

Order Code		RS Q3	Basic RRP	Total RRP inc VAT
-	<b>Audi Warranty</b> , covering you for unlimited mileage in the first two years of ownership, and up to 60,000 miles in the third year. Transferable between owners**	S	No charge	No charge
EA6	<b>Audi Warranty</b> , covering you for up to 4 years or 75,000 miles, whichever comes soonest. Cover includes a 2-year unlimited mileage warranty and up to 75,000 miles in the third and fourth years. Transferable between owners**	●	£270.83	£325.00
EA9	<b>Audi Warranty</b> , covering you for up to 5 years or 90,000 miles, whichever comes soonest. Cover includes a 2-year unlimited mileage warranty and up to 90,000 miles in the third and fourth years. Transferable between owners**	●	£620.83	£745.00

Options are subject to availability and may extend delivery.

- = Not available
- = Available
- S = Standard

\*\*Only available prior to registration of your Audi RS Q3. Please speak to your Audi Centre for full details.

RRP – Recommended Retail Price.

VAT is calculated at 20% but this may alter to reflect any change in the applicable VAT rate.



## Merchandise

From the enthusiasts' motorsport collection to the sophisticated Audi collection, there's a wide variety of adults' and children's clothing, lifestyle accessories and collectables, all of which bear the Audi name.

Please speak to a member of our team at your local Audi Centre to see the full Audi collection and to place an order. A selection of Audi merchandise is also available to buy from [audi.co.uk/merchandise](http://audi.co.uk/merchandise)



# Audi Difference

## The experts in Vorsprung durch Technik

Our Audi Approved Master Technicians have undergone an impressive 100,000 hours of training over a 10-year programme to ensure they have the latest technical expertise for maintaining and servicing your Audi. All our Service Advisors undergo a specialist induction and training to ensure they are Audi professionals and able to talk to you about any issues you may have with your Audi vehicle.

## Servicing tailored to your needs

Regular servicing is key to safeguarding your Audi's performance and a full Audi service history could help you enhance the future re-sale value. To make servicing easy, the Audi Service Schedules have been designed to work with your individual driving style and vehicle.

We offer two different schedules: the fixed Inspection Service and the variable LongLife Service schedule. The conventional fixed Inspection Service schedule has fixed intervals for the Oil-change Service and Inspection Service, which are determined by time and distance.

With the variable LongLife Service schedule, the Inspection Service intervals are also fixed but the Oil-change Service intervals are variable. Sensors take account of driving style and conditions to determine when the Oil-change Service is required and the driver is informed via the on-board service interval display.

The choice of Service Schedule will depend on journey type and mileage as well as individual driving style and conditions. The table to the right can be used for guidance but your Audi Centre will help you to determine the most suitable Service schedule for you based on your individual circumstances and preferences.

### Fixed Inspection Service Schedule

	Vehicle usage:
Mileage	Less than 10,000 miles per annum Mainly city/town centre driving. Short journeys.
	Service Intervals:
Oil-change Service	Fixed to every 9,000+ miles/1 year
Inspection Service	Fixed to every 19,000+ miles/2 years

### Variable LongLife Service Schedule

	Vehicle usage:
Mileage	More than 10,000 miles per annum Motorway and main road driving. Mainly longer distance journeys. Constant speeds.
	Service Intervals:
Oil-change Service	Variable to a maximum of every 19,000+ miles/2 years
Inspection Service	Fixed to every 19,000+ miles/2 years

When a vehicle is frequently used in the following conditions, we recommend a Fixed Inspection Service Schedule, regardless of mileage:

Uneconomical driving styles, e.g. heavy acceleration and braking, constant use of high revs

High engine-loading conditions, e.g. frequent towing and hill climbs

\*As indicated by the service interval display. Mileages are approximate as the Service Indicator system uses kilometres as its distance measurement.

## Your convenience comes first

At Audi you can choose from a range of convenient services that suit your needs. Why not book a 'service while you wait' appointment\* and enjoy our complimentary refreshments while your car is with us? Or, if you need to be mobile, take advantage of one of our courtesy cars which we can even deliver to you.\* We guarantee we can service your Audi within 5 days without a courtesy car or within 10 days if you need transport. We will also ensure your car is returned to you with a full valet.

## Audi Genuine Parts

You can rest assured that only Audi Genuine Parts will be used on your vehicle. What's more, Audi parts and labour come with a 2-year guarantee.\*\*

## No hidden costs

We believe strongly in transparency when it comes to our prices. For added peace of mind, we will give you a quotation over the phone for the work you have requested and email you the price confirmation. We'll consult you if any additional work on your car is needed when it is with us. We won't carry out any extra work without asking your permission first.

## All part of the service

Whenever we see an Audi for a service, we connect it directly to our headquarters in Ingolstadt which enables us to check your car's software and make sure it's as up-to-date as possible. If the factory has released a software upgrade for your model, it can be applied immediately - improving anything from your car's efficiency to the precision of its parking system.

## Audi Roadside Assistance

Your new car comes complete with 3 years' complimentary roadside assistance and recovery across the UK, provided by RAC Motoring Services. Also included is roadside assistance throughout Europe, managed by RAC Motoring Services.

For further information and terms and conditions please visit [audi.co.uk](http://audi.co.uk).

\* Subject to availability.

\*\*Excludes wear and tear.



# RS Q3 technical data

Engine	2.5 TFSI quattro
Transmission	7-speed S tronic
Cylinder	5-cylinder
Displacement, cubic cm (valves per cylinder)	2480
Max. power <sup>1</sup> , PS at rpm	310/5200-6700
Max. torque, Nm at rpm	420/1500-5200
Top speed, mph*	155
0-62mph acceleration, seconds	5.5
CO <sub>2</sub> emissions <sup>2</sup> , g/km	206
Benefit in kind (BIK) %	33%
Fuel consumption <sup>2</sup> , mpg (l/100km) Urban	23.2 (12.2)
Fuel consumption <sup>2</sup> , mpg (l/100km) Extra Urban	40.9 (6.9)
Fuel consumption <sup>2</sup> , mpg (l/100km) Combined	32.1 (8.8)
ABI insurance group 1-50**	TBC
Unladen weight <sup>3</sup> , kg	1655
Gross weight limit, kg	2215
Roof load limit/ nose weight, kg	75/80
Max trailer load unbraked	750
Max load 12%	1900
Max load 8%	1900
Luggage compartment, seats upright, litres <sup>4</sup>	356
Luggage compartment, seats folded, litres <sup>4</sup>	1261
Fuel tank capacity approx, litres	64
Emission standard	EU5

\*Electronically limited. Please see page 45 for option to increase limit.

\*\*Highest insurance group rating shown. Group may be lower dependent on trim level. Please visit [www.thatcham.org/abigrouprating](http://www.thatcham.org/abigrouprating) for details.

<sup>1</sup>The given value was obtained in accordance with the specified measurement procedure (the respective current version of Directive 80/1269/EEC).

<sup>2</sup>Fuel consumption and CO<sub>2</sub> emissions figures are obtained under standardised test conditions (Directive 93/116/EEC) using a representative model. This allows direct comparison between different models from different manufacturers, but may not represent the actual fuel consumption achieved in 'real world' driving conditions. More information is available at [www.vca.gov.uk](http://www.vca.gov.uk).

<sup>3</sup>Vehicle's unladen weight without driver (calculated in accordance with the current version of Directive 92/21/EEC). The fitting of additional equipment may increase the vehicle's unladen weight and drag coefficient, whereupon the potential carrying capacity and top speed will be correspondingly reduced.

<sup>4</sup>Second value; loaded up to roof with rear seat folded down.



# RS Q3 dimensions

The technical drawings opposite show the exact dimensions of the RS Q3, so you can check everything – from whether the car will fit in your garage to whether your luggage will fit in the boot.

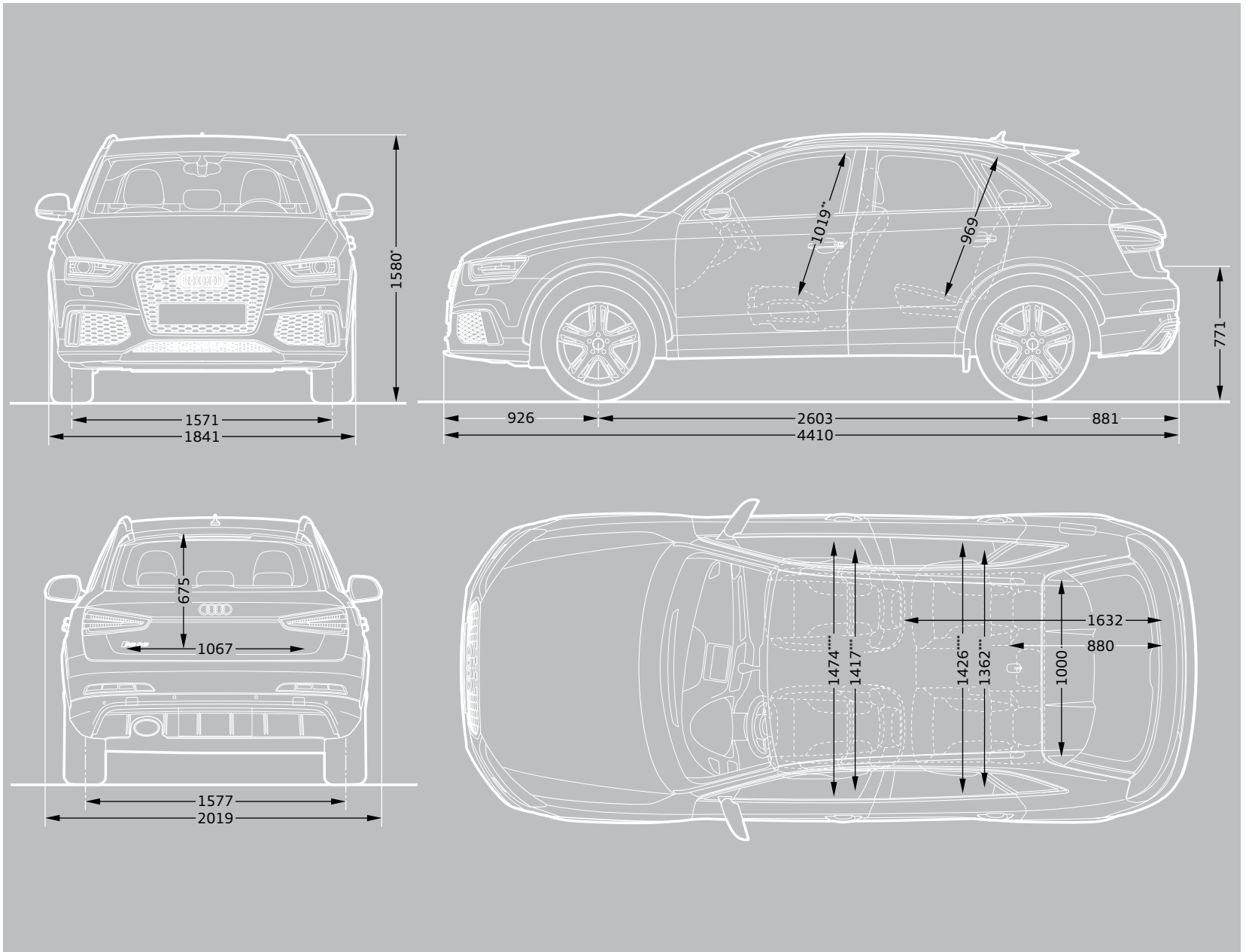

Dimensions in millimetres

\*With roof aerial the height of the vehicle is 1598mm

\*\*Maximum headroom

\*\*\*Shoulder width room

\*\*\*\*Elbow width room

Dimensions were measured with vehicle at unladen weight, ground clearance measured with vehicle carrying its maximum load.

Luggage compartment volume in litres: 565/1,680 (measured by the VDA standard test method using 200 x 100 x 50mm blocks; second value: with rear seat folded down). Turning circle approx. 11.9m.

# Pricing and Additional information

## Welcome to Audi

By placing an order for your Audi, you're choosing to get behind the wheel of one of the most sophisticated cars on the road. And because we believe the service we offer should be just as advanced, we want to let you know exactly what you can expect from us, now and in the future.

We've agreed a set of standards with all our Centres which governs the way we do business with you. It outlines the kind of service we promise to deliver for every customer, right down to filling each new Audi we sell with half a tank of fuel.

So whether you're interested in the date your car will arrive in the UK or the way we'll dispose of non-biodegradable materials after we service your Audi, you can have total confidence in us.

## Audi Promise

### Audi Centres

We guarantee that all our Centres will be open as follows:

Sales: Monday to Friday 9am–6pm  
Saturday 9am–5pm

Service: Monday to Friday 8am–6pm  
Saturday 8.30am–1pm

Sunday opening is at local discretion.

### New car delivery

Once we've confirmed a delivery date for your car, we'll keep you informed of progress. Subject to reasonable notice, we'll then deliver it to a place of your choice, whether that's your home or work. In the unlikely event of a delay, we'll provide a courtesy car to minimise inconvenience and keep you mobile.

### Environmental commitment

We promise to dispose of all non-biodegradable materials from your vehicle in a responsible manner.

### Pricing

Prices and specifications given are correct at the time of printing. Always check details with your Audi Centre as Audi policies are continually developing. We reserve the right to change prices or specifications at any time.

All prices are subject to VAT, currently charged at 20%, **but this may alter to reflect any change in the applicable VAT rate.**

Delivery charges and number plates are not included in the vehicle price.

Delivery charge	£471.66
Number plate	£20.00
VAT	£98.34
Total	£590.00

## Audi Customer Care

Every new Audi benefits from the comprehensive Audi Customer Care Package, which comprises:

- ▶ A 3-year Audi warranty, which covers you for unlimited mileage in the first 2 years of ownership, with a full mechanical and electrical warranty which covers you for up to 60,000 miles in the 3rd year
- ▶ A 3-year paint warranty
- ▶ A 12-year anti-corrosion warranty
- ▶ 3 years' UK roadside assistance and recovery

You also have the option when ordering your new car of choosing a 4-year or 5-year Audi warranty. Speak to a member of the sales team for more information.

### Audi tax-free sales

If you are entitled to purchase a vehicle free of VAT, normally through military or diplomatic privilege, please contact your local Audi Centre for full details.

Should you have any difficulty obtaining the information you require, please call 01908 548 356.

### Audi Finance

Audi Finance specialises in providing funding solutions for Audi drivers. Whether your Audi is for private or business use, there is a range of funding options to choose from.

Below is the full range of finance products, which comprises:

- ▶ Solutions – a Personal Contract Plan
- ▶ Hire purchase
- ▶ Lease purchase
- ▶ Finance lease
- ▶ Contract hire

With all products, you can choose a fixed-cost maintenance plan designed to help you budget accurately.

No matter which Audi model you choose, your local Audi Centre can provide you with a personalised quote designed to fit your budget and motoring needs.

Audi Finance is a trading name of Volkswagen Financial Services (UK) Limited. An offer of finance depends on certain conditions. Available to people over 18 in the UK only.

### Audi Insurance

We want you to start enjoying your new car from day one and thanks to Audi Insurance complimentary 7-day cover, you can. Call free on 0800 316 7893 (lines are open Monday to Friday 8am–9pm, and Saturday 9am–5pm), provide a few details and a cover note will be sent to your Audi Centre. They will then tax your car and you can drive it away.

## Additional information

### CO<sub>2</sub> data and information

#### CO<sub>2</sub> emissions-based Vehicle Excise Duty

Vehicle Excise Duty (Road Fund Licence) is based upon the amount of Carbon Dioxide (CO<sub>2</sub>) a vehicle emits, measured in grams per kilometre (g/km). First year VED rates apply to the first year of ownership. Annual VED rates apply thereafter. The DVLA has created thirteen categories:

Petrol and Diesel engines	First year	Annual rate (second year onwards)
A – up to 100g/km	£0.00	£0.00
B – 101 to 110g/km	£0.00	£20.00
C – 111 to 120g/km	£0.00	£30.00
D – 121 to 130g/km	£0.00	£105.00
E – 131 to 140g/km	£125.00	£125.00
F – 141 to 150g/km	£140.00	£140.00
G – 151 to 165g/km	£175.00	£175.00
H – 166 to 175g/km	£285.00	£200.00
I – 176 to 185g/km	£335.00	£220.00
J – 186 to 200g/km	£475.00	£260.00
K – 201 to 225g/km	£620.00	£280.00
L – 226 to 255g/km	£840.00	£475.00
M – over 255g/km	£1,065.00	£490.00

Vehicle Excise Duty (VED) rates correct at time of going to print, but these may alter to reflect any change in the applicable VED rate











**Audi UK**

Customer Services  
Selectapost 29  
Sheffield  
S97 3FG  
0800 699888  
audi.co.uk

Specifications and prices subject  
to change without notice.

© Audi UK

Printed in the UK  
Edition 0.1 08/13  
2014 model year

Images are for illustrative purposes only.