

F-TYPE





F-TYPE

It had to be powerful, agile and utterly distinctive. It had to look, feel and drive like a Jaguar. A true Jaguar sports car; the latest in a distinguished bloodline. We couldn't just call it F-TYPE; we had to make it F-TYPE.

F-TYPE is engineered for high performance and instantaneously responsive handling. Powerful, supercharged engines and a lightning-fast gearbox; lightweight aluminium body construction and an obsession with balance and proportion; superb suspension and a host of advanced driving technologies; peerless design and a driver-focused cockpit.

Together they produce a uniquely connected driving experience, and a sports car that only Jaguar could create - ultra-precise, powerful, sensual and, most of all, alive.

VEHICLE SHOWN ON FRONT COVER AND LEFT: F-TYPE V8 S IN SALSA RED
VEHICLE SHOWN ON BACK COVER: F-TYPE IN STRATUS GREY

PURE DRIVING PLEASURE

F-TYPE's technical excellence delivers a breadth of capabilities to suit the road, the conditions and the demands of the driver.



VEHICLES SHOWN: F-TYPE IN STRATUS GREY





THREE DIFFERENT LIVES

There are three models, each equally at home on the switchback of a mountain pass, on the motorway or in the city, with each offering its own distinctive flavour and driving characteristics.

F-TYPE is designed to deliver pure driving pleasure. It combines effortless, exhilarating performance, instant response and precise, agile handling, with everyday refinement and usability.

F-TYPE S adds greater power and an increased range of sophisticated driving technologies.

F-TYPE V8 S offers stunning performance and even greater levels of dynamic ability and control.



F-TYPE

- 3.0 V6 340 Supercharged
- Jaguar Performance Braking System
- Sports Suspension
- Sports Exhaust

VEHICLE SHOWN: F-TYPE IN STRATUS GREY

F-TYPE S

- 3.0 V6 380 Supercharged
- Jaguar High Performance Braking System
- Sports Suspension with Adaptive Dynamics
- Active Sports Exhaust
- Limited Slip Differential

VEHICLE SHOWN: F-TYPE S IN SATELLITE GREY

F-TYPE V8 S

- 5.0 V8 495 Supercharged
- Jaguar Super Performance Braking System
- Sports Suspension with Adaptive Dynamics
- Active Sports Exhaust
- Electronic Active Differential
- Quad Exhaust Pipes

VEHICLE SHOWN: F-TYPE V8 S IN SALSA RED

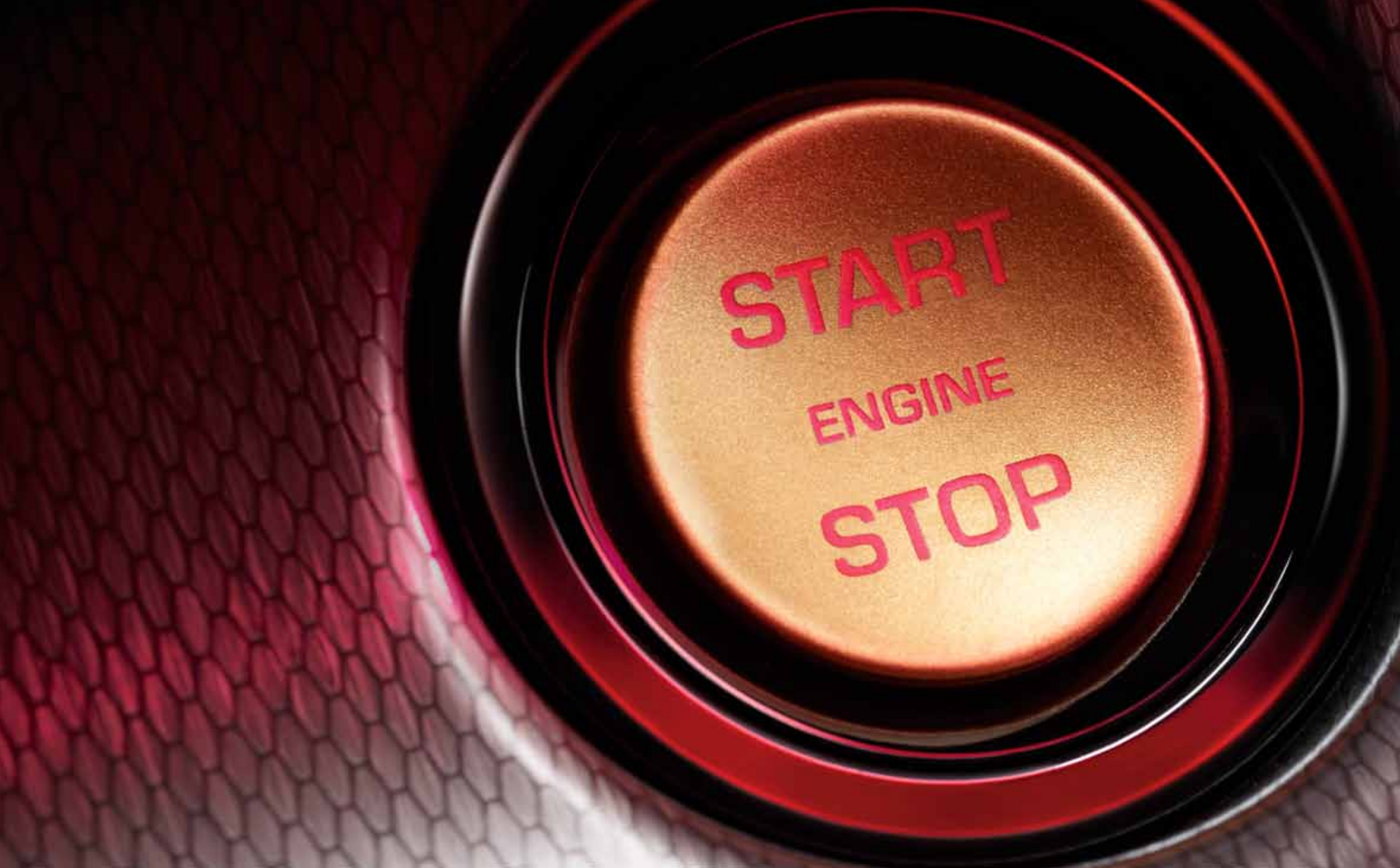

SUPERCHARGED ENGINES

Power is delivered from a range of three highly advanced engines – 3.0 V6 340PS, 3.0 V6 380PS and 5.0 V8 495PS. Each features a Roots-type twin vortex supercharger mounted in the 'V' of the engine to maintain the powerplants' compact dimensions.

Jaguar is a leader in the field of **Supercharged induction technology**. The advantages of supercharging are clear and compelling. It provides a linear delivery of performance, and instant access to high levels of torque at all engine speeds, minimising the gap between the driver's demand for power and the engine's response.

F-TYPE's Sports Exhaust delivers a crisp note from start up and builds to a race car-inspired crescendo at high rpm and during overrun. An **Active Sports Exhaust** is standard on **F-TYPE S** and **F-TYPE V8 S** and optional on **F-TYPE**. The system features active bypass valves which open during performance driving to allow exhaust gases to exit more directly for a deep, dramatic sound. The optional **Switchable Active Exhaust** allows manual control of the system, for even greater driver involvement.

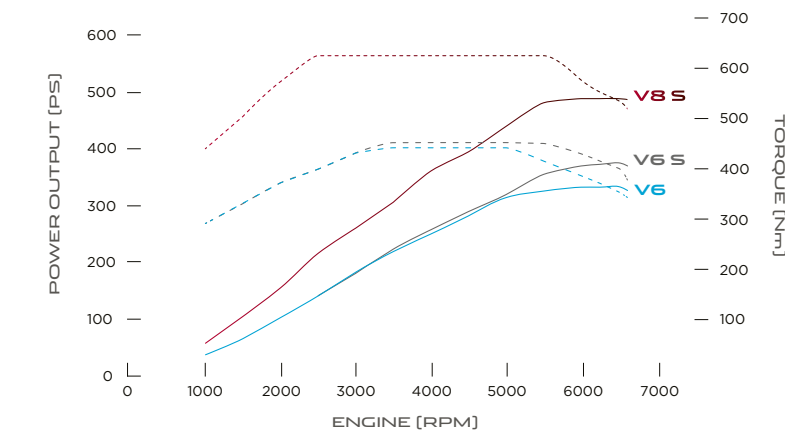

V6

3.0 LITRE 340PS

3.0 LITRE 380PS



0-60 MPH

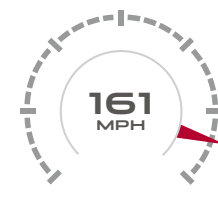

TOP SPEED MPH



0-60 MPH

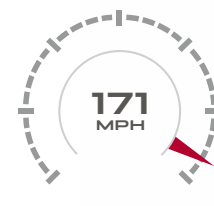

TOP SPEED MPH

Jaguar's new generation supercharged 3.0 V6 engines are powerful and refined. Generating extremely high specific power outputs of up to 126.7PS per litre, they deliver thrilling performance and a rewarding driving experience. The compact supercharger's sophisticated boost control and secondary throttle valve ensure the torque curves rise steeply over a broad range of engine speeds. A water-cooled intercooler reduces the temperature of the intake air for greater power and efficiency, whilst an innovative system of counter-rotating front and rear balancer weights aids smoothness and refinement. They also feature a fast-reacting **Intelligent Stop/Start** system that can improve fuel economy by up to 5 percent.



V8

5.0 LITRE 495PS



0-60 MPH

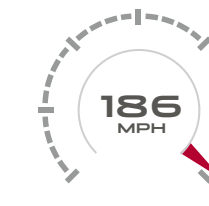

TOP SPEED MPH

The 495PS 5.0 V8 is supremely powerful. A larger supercharger feeds the engine to deliver an astonishing peak torque of 625Nm from just 2,500rpm. Acceleration is rapid and progressive, response is immediate and predictable. Advanced technologies deliver performance, refinement and efficiency. The lightweight die-cast aluminium block is supplemented by cross-bolted main bearing caps to increase rigidity. Valves are controlled by dual independent variable cam timing to optimise power at all engine speeds. Spray-guided direct injection delivers precisely-measured quantities of fuel directly into the centre of the combustion chambers at pressures of up to 150bar for cleaner, more efficient combustion. In common with the V6 engines, it also features an **Intelligent Stop/Start** system that can improve fuel economy by up to 5 percent.



QUICKSHIFT TRANSMISSION

- 8-SPEED RATIOS
- ADAPTIVE SOFTWARE
- INSTANTANEOUS RESPONSE

F-TYPE's Quickshift automatic transmission is both lightning-fast and superbly refined, offering the benefits of a double clutch transmission and a conventional automatic without the limitations of either. Eight closely-spaced ratios keep the engine within its most effective rev range for longer, providing instantaneous response and outstanding driver feedback, while also optimising the engine for both economy and outright performance.

The transmission control system is intelligent and adaptive. It monitors the driving situation together with the demands the driver is making on the car, and responds to provide a truly dynamic experience. Adaptive software automatically modifies the gear shift strategy, ensuring the right gear is selected for every situation. **Fast Throttle-Off** recognises when the driver is making rapid throttle adjustments, for example during multiple manoeuvres, and automatically holds the gear ratio in anticipation of the next move. **Corner Recognition** senses when the car is in a corner and holds the ratio ensuring the car is in the correct gear when exiting a bend. When decelerating and changing down, the **Speed Matching Management System** matches the engine speed to the gearbox speed, and automatically 'blips' the throttle during downshifts when in Sport Automatic mode, while **Spontaneous Vehicle Deceleration** enables F-TYPE to rapidly downshift under very hard braking conditions.

Dynamic Launch Mode, standard on **F-TYPE S**, applies maximum torque through the gear changes delivering optimum acceleration from rest to 60 mph.

The driver can, of course, take full manual control of the transmission using either gear shift paddles mounted behind the steering wheel, or the joystick-style SportShift gear selector. Once in manual mode, the Quickshift system delivers rapid and precisely-timed engine torque interventions, creating shorter and crisper sounding gear shifts.



LIGHTWEIGHT ALUMINIUM CONSTRUCTION



STRONG AND RIGID

HIGH POWER-TO-WEIGHT AND TORQUE-TO-WEIGHT RATIOS

Jaguar has been at the forefront of aluminium car construction for more than a decade and continues to push the boundaries of the technology. F-TYPE builds on this expertise and uses advanced techniques derived from the aerospace industry, such as epoxy bonding and riveting, to contribute towards the car's light, strong and rigid body structure.

A lightweight aluminium body structure with high torsional rigidity is the ideal platform for a convertible sports car, and is fundamental to the way F-TYPE performs, handles and feels. A strong, stiff structure provides an inherently stable platform for precise, agile handling and allows the finely-tuned suspension system to deliver connectivity and driver feedback. F-TYPE's body is the perfect complement to its high-performance engine range. Together they produce the exceptional power-to-weight and torque-to-weight ratios that deliver the real world measures of performance in a sports car.

All exterior panels are aluminium alloy with the exception of the boot lid which is made from composite materials, allowing hidden aerials to receive GPS and radio signals. These exterior panels are constructed from a new **AC600 alloy** that combines robustness and quality of finish with much greater formability for greater clarity and tightness of radii and feature lines. Jaguar has also developed a new **'warm forming'** technique for the inner door pressings which works like vacuum forming, using sheet metal rather than plastic. The use of advanced materials and innovative techniques allowed Jaguar's engineers to reproduce F-TYPE's beautifully crisp, crafted lines exactly as the designers had intended, as well as delivering a vehicle with extraordinary structural integrity.



ON BALANCE



OPTIMUM WEIGHT DISTRIBUTION

LOW CENTRE OF GRAVITY

PERFECT PROPORTIONS

It is essential in the design of a great sports car that weight is kept to a minimum, is evenly distributed front to rear and that the centre of gravity is kept as low as possible. This configuration in F-TYPE means that the car has natural balance and is the result of meticulous attention to detail during the design and construction of the body structure. An uncompromising focus on weight distribution achieves the optimum balance between front and rear wheels, with items such as the battery, electronic systems and even the washer bottle located at the rear of the car.

A shorter car is more agile; a wider car is more stable. The relationship between F-TYPE's length of 4,470mm and width of 1,923mm is precisely engineered to deliver inherent agility and means that the car has outstanding driving dynamics. Its low centre of gravity reduces body roll in corners, while short front and rear overhangs mean that the mass is concentrated within the wheelbase. These essential factors combine to ensure that F-TYPE is naturally agile.

MOMENT OF MASS INERTIA

The closer the weight is to the centre of the car, the easier it is to turn the car.

$$I = \sum_{i=1}^N m_i r_i^2$$

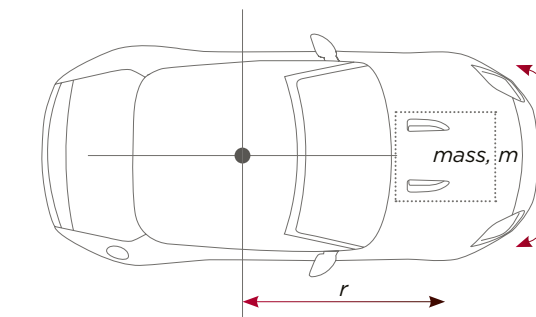

VEHICLE SHOWN: F-TYPE V8 S IN SALSA RED

NARDO RING TEST TRACK
ITALY

700 hectares of land with a 3.85 mile long handling circuit and a 7.77 mile long oval

HIGH-SPEED STABILITY TESTING



NÜRBURGRING NORDSCHLEIFE
GERMANY

Asphalt and concrete mixed surface. 12.93 miles long with 73 turns

DYNAMICS TESTING



DEATH VALLEY
CALIFORNIA

Temperature up to 46.9°C

HOT CLIMATE TESTING



PUT TO THE TEST

F-TYPE first took to the road in the virtual world of Jaguar's Computer Aided Engineering (CAE) environment to ensure that all components underwent extensive development and testing before being committed to the physical testing process. Engineers produced a series of virtual prototypes to realistically simulate the behaviour of complex mechanical systems allowing them to analyse multiple variations until the optimum design was achieved. For example, using a technique first used in the aerospace industry, aerodynamic testing took place in a virtual wind tunnel with Computational Fluid Dynamics running on high speed supercomputers. During its virtual life, F-TYPE completed half a million analyses, requiring 10 million computer processor hours and creating 300TB of data. The CAE development process was one of the key contributing factors in delivering F-TYPE's exhilarating performance and responsiveness.

COMPUTER AIDED ENGINEERING | **COMPUTATIONAL FLUID DYNAMICS** | **10 MILLION PROCESSOR HOURS**

The real world testing to prove the car and fine tune the set-up took place in specialist facilities and the harshest environments across the globe in temperatures ranging from -40°C to +46.9°C, and at altitudes of up to 4,000m. High-speed stability tests, for example, were conducted at Nardo in southern Italy. The Nordschleife circuit at the Nürburgring in Germany was the perfect location to prove out handling, braking, cooling and durability. Known as the "Green Hell", and featuring 12.93 miles of track with 73 turns, it is renowned as the most demanding circuit in the world and the ultimate test of both car and driver.



BROUGHT TO LIFE

The essential ingredients in place, F-TYPE is ready to take on the world's most thrilling roads. You'll discover an intuitive and instinctive driving experience like no other. An experience that surpasses high performance and pin sharp handling to deliver pure entertainment. The most awe-inspiring and exhilarating twists and turns on the road belong to F-TYPE.



ACTIVE AERODYNAMICS

➤ 60 MPH INITIATES AUTO DEPLOY | REDUCES LIFT BY UP TO 120KG | 40 MPH INITIATES AUTO RETRACT

Aerodynamic performance is the essence of F-TYPE's design and is seamlessly integrated into the body for low levels of lift and excellent stability at high speed. A front splitter beneath the grille and rear venturi manages airflow along the vehicle's underside with the sharply defined tail helping air to separate cleanly at lower speeds. A deployable rear spoiler rises at speeds in excess of 60 mph to **reduce lift by up to 120kg**. Even the door handles retract when not required, with their flush design creating an uninterrupted air flow along the flanks.





THE FASTEST CONNECTION BETWEEN DRIVER AND ROAD

F-TYPE's quick, responsive steering is designed to provide the most direct connection between the driver's hands on the wheel and the contact point of the tyres on the road. The car's quick steering rack delivers a precise reaction to driver input. The feeling of connection is also maximised by the use of aluminium alloy for the front subframe. This not only helps to reduce weight, but, in conjunction with F-TYPE's forged alloy suspension, also creates an immensely strong structure for the ultimate in precise feedback and control.

VEHICLES SHOWN: F-TYPE V8 S IN SALSA RED



PERFORMANCE BRAKING SYSTEMS

Three braking systems are available, each engineered to deliver confident, progressive feel and sustained, consistent high performance. The front calipers make extensive use of aluminium to reduce the unsprung mass of the car, benefiting both handling and ride refinement. Each system features large, ventilated brake discs - up to 380mm in diameter on the High Performance and Super Performance systems. This large swept area improves braking force, as well as providing greater capacity for the discs to absorb and dissipate the heat energy generated during braking.

Brake cooling is also enhanced with additional suspension scoops and ducts developed with the assistance of advanced Computational Fluid Dynamics systems. This channels cooling air directly to the brakes to help sustain their performance during extended periods of dynamic driving.

F-TYPE
JAGUAR
PERFORMANCE

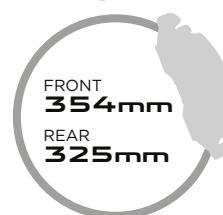

CALIPERS: SILVER (STANDARD)

F-TYPE S
JAGUAR HIGH
PERFORMANCE

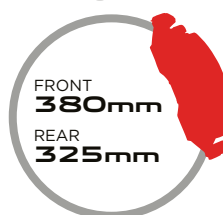

CALIPERS: RED (STANDARD)
BLACK (OPTIONAL)

F-TYPE V8 S
JAGUAR SUPER
PERFORMANCE*

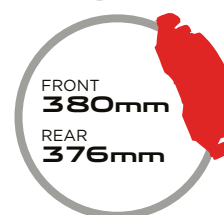

CALIPERS: RED (STANDARD)
BLACK (OPTIONAL)

*Jaguar Super Performance brakes available as an option on F-TYPE (when 19" or 20" alloy wheels are selected) and F-TYPE S models

VEHICLE SHOWN: F-TYPE V8 S IN SALSA RED





VEHICLES SHOWN: F-TYPE V8 S IN SALSA RED

CHASSIS AND SUSPENSION

F-TYPE's aluminium body creates an immensely stable platform from which the all-round forged aluminium double wishbone suspension controls the car. With the damping set-up optimised for the best partnership between dynamics and refinement, it gives the perfect combination of control, agility and feedback.

On **F-TYPE S** and **F-TYPE V8 S** models, Adaptive Damping assesses body motion and pitch rates 100 times per second, and adjusts the settings for each damper accordingly. The system improves control, handling and agility, as well as the ability to rapidly detect and react to critical driving conditions and driver demands. It achieves this with a series of sensors that are placed around the car to monitor the body's vertical movement and pitch. The steering wheel position is measured 500 times per second enabling the system to predict the body's roll rate. The stiffness of each individual damper is then adjusted to help maintain body control, stability and agility.

MONITORS ROAD-INDUCED BODY MOTION **100 TIMES** PER SECOND

MONITORS STEERING WHEEL INPUT **500 TIMES** PER SECOND

PREDICTS PITCH FROM THROTTLE AND BRAKE INPUTS

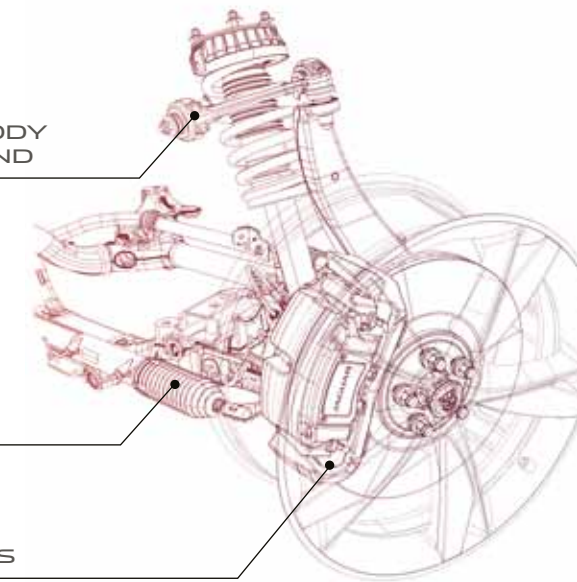

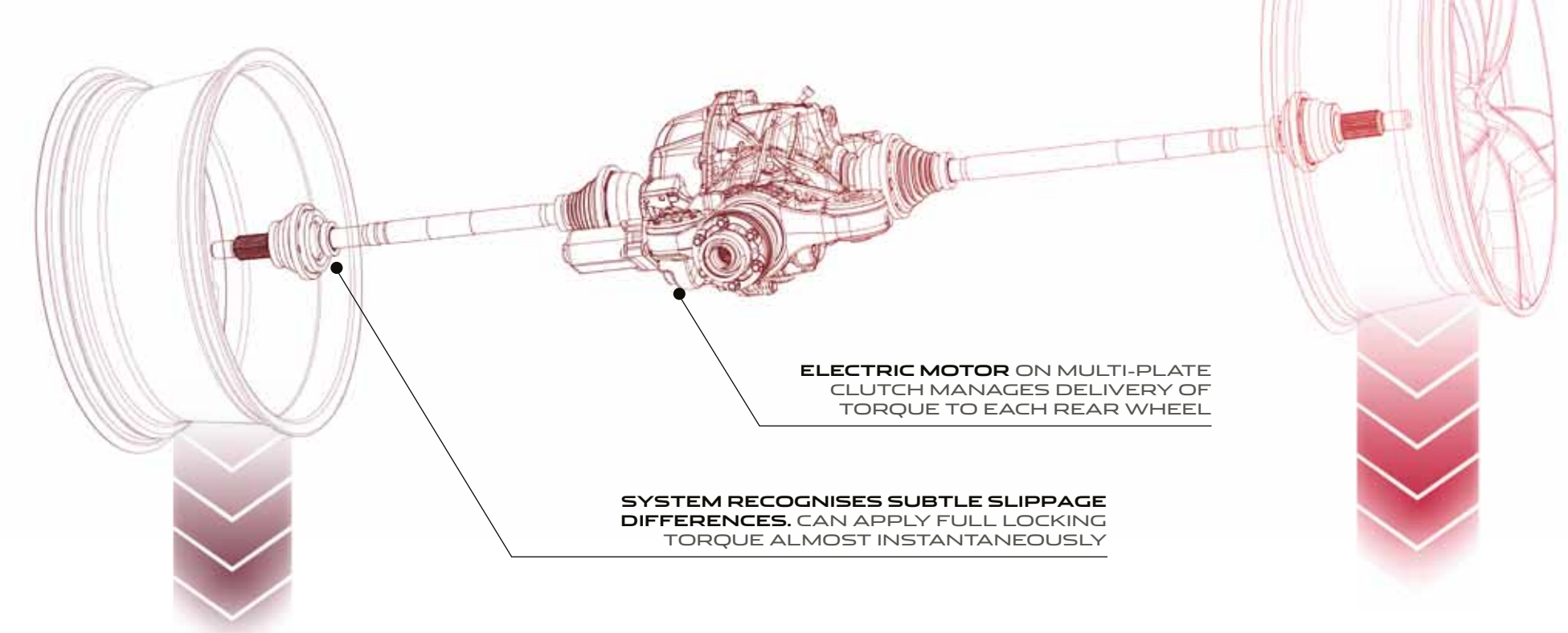

ELECTRIC MOTOR ON MULTI-PLATE CLUTCH MANAGES DELIVERY OF TORQUE TO EACH REAR WHEEL

SYSTEM RECOGNISES SUBTLE SLIPPAGE DIFFERENCES. CAN APPLY FULL LOCKING TORQUE ALMOST INSTANTANEOUSLY

DIFFERENTIALS

The mechanical **Limited Slip Differential** featured in **F-TYPE S** was chosen because of its innate suitability for the rear-wheel drive sports car experience. It offers the perfect opportunity to leverage the car's superb handling and the upper limits of its grip. The Limited Slip Differential improves traction and agility during acceleration out of corners and on slippery surfaces. The car can also make better use of the available traction before the DSC system needs to intervene and results in more refined stability control during dynamic driving.

An **Electronic Active Differential** provides **F-TYPE V8 S** with the ultimate in agility and control. Working in conjunction with the stability, traction and ABS systems, the Electronic Active Differential uses an electric motor acting on a multi-plate clutch to manage the delivery of torque to each of the rear wheels. Full electronic control of the rear differential lock enables the system to apply full locking torque almost instantaneously. The Electronic Active Differential allows for very fine control of the power delivery to limit wheelspin, maximise traction and offer even greater levels of control.

VEHICLE SHOWN: F-TYPE V8 S IN SALSA RED



ADAPTIVE DYNAMICS

Adaptive Dynamics instinctively modifies the car's response to road conditions and driver input, enhancing the driving experience. It analyses how the car is being driven by measuring acceleration and braking, cornering, as well as road load and kick down activation. It then uses sophisticated adaptive software to ensure that the most appropriate gear shift strategy is automatically selected. For even more responsive performance, the selection of Sport Mode alters the gear shift programme to deliver shorter shifts and hold ratios at higher revs for longer.

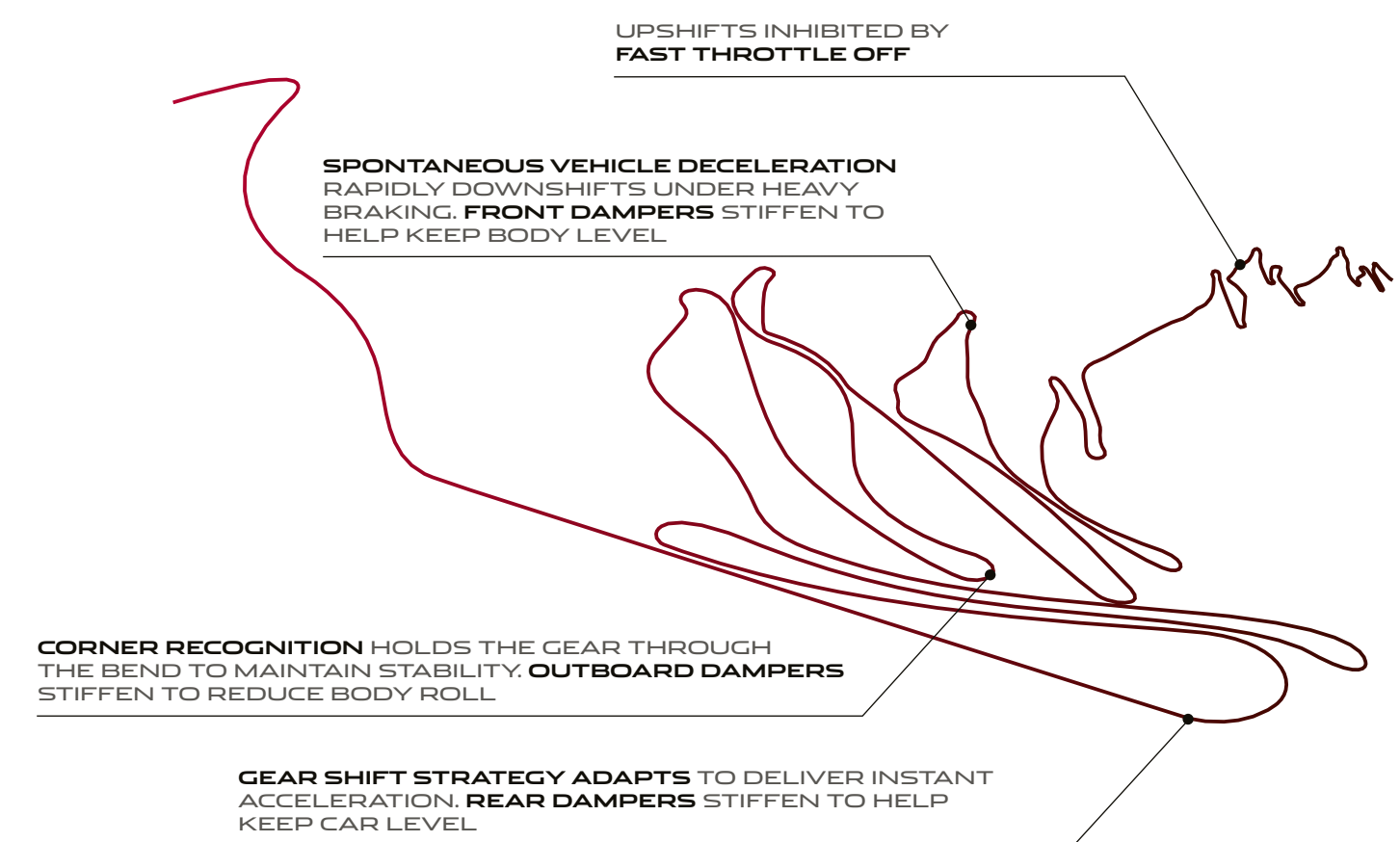



DYNAMIC MODE

SHARPENED THROTTLE RESPONSE | **QUICKER** GEAR SHIFTS

Dynamic Mode remaps the car's software to further emphasise its sporting character. It sharpens the throttle response, increases steering weighting and performs gear shifts more quickly and at higher engine speeds. Selecting Dynamic Mode also prevents automatic upshifts when the gearbox is used in manual mode.

On **F-TYPE S** and **F-TYPE V8 S** models, the **Configurable Dynamics** system allows the driver to define which characteristics are altered when Dynamic Mode is selected. This option also features the **Dynamic-i** display system, which can show performance indices such as G-Force meter and lap time, plus throttle, steering and brake inputs on the 8 inch Touch-screen.



ASSISTANCE AND REASSURANCE

➤ BLIND SPOT MONITOR | REVERSE TRAFFIC DETECTION | INTELLIGENT HIGH BEAM

Sophisticated driver assistance systems are available to provide reassurance, information and control, and allow the driver to focus on the pleasure of the drive. These include **Cruise Control with Automatic Speed Limiter** and **Blind Spot Monitoring**, which is designed to help alert the driver to the presence of a vehicle in an adjacent lane. **Reverse Traffic Detection** can provide warnings of other vehicles in the reversing path of F-TYPE, for example when in a car park. **Front and Rear Parking Aids** and a **Reverse Park Camera** also provide valuable assistance during parking manoeuvres.

Bi-function HID Xenon headlamps provide an intense white light for both main and dipped beam in a single unit. The optional **Adaptive Front Lighting** system measures the speed of the car and angle of the steering wheel, swivelling the lamps by up to 14 degrees out, and up to 7 degrees in, for improved visibility during cornering. The optional **Intelligent High Beam** system automatically switches between low and high beam when necessary, using a sensor mounted at the front of the rear view mirror. The rear lamps feature LED technology with light guides that not only create a distinctive design, but also have the ability to illuminate to full brightness more quickly than conventional bulbs, potentially giving a following driver more time to react.

Every F-TYPE also features a complement of advanced active and passive safety systems, including **Emergency Brake Assist (EBA)**, **Electronic Brake-Force Distribution (EBD)**, driver and passenger front airbags, seat mounted airbags with head protection, seat belt pre-tensioners, roll over protection bars and an industry-leading **Pedestrian Contact Sensing System™**.

VEHICLE SHOWN: F-TYPE S IN SATELLITE GREY



1+1

F-TYPE immediately connects with the driver, so that he or she becomes almost an extension of the car. Its 1+1 configuration is designed to wrap around the driver. The cockpit's design provides visibility, minimal distractions and close-to-the-centre-of-gravity seating with rigid seat frames and structure. The fascia has been intentionally kept as low as possible and free from clutter to increase the forward view. The **Intelligent Venting System**, part of the advanced climate control system, hides the twin central air vents which automatically deploy when required, rising from the dashboard and retracting after use. Two seat styles are available, the standard **Sports Seat**, and an optional **Performance Seat**, offering enhanced lateral support during rapid cornering and upholstered in Premium leather. For the ultimate in luxury, all models can also be specified with the optional **Premium leather interior**, which adds leather to the upper fascia, centre console and door casings.





DRIVER-ORIENTATED CONTROLS

F-TYPE presents information to the driver only as necessary or when requested. Instruments are simple, clear and easy to read featuring two large analogue dials - essential in a sports car. The three spoke design of the steering wheel incorporates key functions, with gear shift paddles mounted behind the spokes for manual control without the need for the driver's hands to be taken from the wheel.

The **Jaguar SportShift Selector** is simple and intuitive to use, inviting greater driver involvement: it offers full Auto mode plus, in Sports mode, manual operation. This allows the driver to select gears sequentially by tipping the lever forward to shift down a ratio and shift up a gear by pulling the lever back.

Dual Mode Rotary Switches are used as part of the controls for the advanced climate control system. Right and left dials control cockpit temperature on the respective sides of the car when dual zone climate control is specified. When pressed, the dials change mode to control the optional seat heating functions, with the screen at the centre of the dial changing to display the corresponding use.

F-TYPE's **8 inch colour Touch-screen** provides simple control of a number of the car's features, including Navigation, Infotainment and, where specified, the Dynamic-i display system.

INTERIORS SHOWN: F-TYPE S WITH PERFORMANCE SEATS IN JET PREMIUM LEATHER WITH PREMIUM LEATHER INTERIOR



THE FEELING INSIDE



F-TYPE's interior conveys a combination of functional ergonomics with sporting style through its meticulously considered cockpit architecture, its simple controls and its clear instrumentation. It is designed to put the driver first and to be an opportunity for individual expression. Everything offers a rewarding, highly tactile experience with extensive ranges of fine leathers, colours and materials making it more personal. Push the Start button and the car comes alive with a cascade of light from the switchgear. **Configurable Lighting**, standard on **F-TYPE S** and **F-TYPE V8 S**, adds even greater personalisation with choices of Phosphor Blue, Pale Blue, White, Coral or Red to suit the driver's mood. Activate Dynamic Mode and the lighting switches to Red on the door grab handles, centre console and instrument cluster.



IN-CAR ENTERTAINMENT



**JAGUAR 180W
SOUND SYSTEM**

**MERIDIAN SOUND
SYSTEM 380W**

**MERIDIAN SURROUND
SOUND SYSTEM 770W**

Three superb audio systems bring the cockpit to life with incredible, rich sound.

The superb **Jaguar Sound System** brings depth and power to in-car entertainment with 6 speakers, 180W and 8 channels. The system features Dynamic Volume Control which compensates for changes in sound levels within the car to ensure that audio quality is always consistent.

Two higher specification systems were designed in conjunction with British audio experts Meridian specifically for F-TYPE. They feature advanced technology such as Digital Signal Processor (DSP) software to optimise every element of the system and use Meridian Cabin Correction's advanced algorithm to redefine the operating parameters and ensure that the audio experience is superbly consistent - roof up or roof down. The **Meridian Sound System** offers superb audio reproduction through 10 speakers - including 2 sub woofers, 380W and 12 channels. The ultimate **Meridian Surround Sound System** features 12 speakers including 2 sub woofers and 770W of power. This advanced system uses Meridian Trifield™ technology to ensure a perfect stereo image for both driver and passenger.

VEHICLE SHOWN: F-TYPE S IN SATELLITE GREY



MODELS

STANDARD FEATURES

Quickshift 8-speed automatic transmission with SportShift selector and steering wheel-mounted one touch paddles

Dynamic mode

Dynamic Stability Control (DSC) with Trac DSC mode

Open differential

Intelligent Stop/Start system

Electric Parking Brake (EPB) – drive-away release

Deployable rear spoiler

Deployable door handles

Bi-function HID Xenon headlamps with washers and LED signature lights

LED tail lamps

Electronically-operated convertible roof

Jaguar Smart Key System™ with Keyless start

Instrument cluster – Twin dials with 5" colour TFT display

8" colour Touch-screen display

Navigation system

Jaguar 180W Sound System with single slot CD/DVD

USB, Auxiliary socket and iPod connectivity

Roll Over Protection Bars

Pedestrian Contact Sensing System™

Rear parking aid with Touch-screen visual indicator

Single zone Automatic Climate Control

Electric 6x6 way Sports seat

Ambient interior lighting

Bluetooth® telephone connectivity

DAB Radio



F-TYPE

ENGINE 3.0 Litre V6 340 Supercharged

ACCELERATION 0-60 mph 5.1 seconds

TOP SPEED 161 mph

EMISSIONS CO₂ 209 g/km

Jaguar Performance Braking System with Silver calipers

Sports suspension

Sports Exhaust

Centre mounted twin exhaust pipes

18" Vela alloy wheels

Sports seats with leather and Suedecloth facings

3-spoke leather steering wheel with Black gear shift paddles

Light Hex Aluminium console finisher

F-TYPE S

ENGINE 3.0 Litre V6 380 Supercharged

ACCELERATION 0-60 mph 4.8 seconds

TOP SPEED 171 mph

EMISSIONS CO₂ 213 g/km

Jaguar High Performance Braking System with Red calipers

Sports suspension with Adaptive Dynamics

Active Sports Exhaust

Centre mounted twin exhaust pipes

19" Propeller Silver alloy wheels

Configurable Dynamics System

Limited Slip Differential

Sports seats with leather facings

3-spoke leather steering wheel with Ignis gear shift paddles

Dark Hex Aluminium console finisher with 'S' graphic

Configurable Ambient Interior Lighting with selectable palette

F-TYPE V8 S

ENGINE 5.0 Litre V8 495 Supercharged

ACCELERATION 0-60 mph 4.2 seconds

TOP SPEED 186 mph

EMISSIONS CO₂ 259 g/km

Jaguar Super Performance Braking System with Red calipers

Sports suspension with Adaptive Dynamics

Active Sports Exhaust

Quad exhaust pipes

20" Turbine Silver alloy wheels

Configurable Dynamics System

Electronic Active Differential

Sports seats with leather facings

3-spoke leather steering wheel with Ignis gear shift paddles

Dark Hex Aluminium console finisher with 'S' graphic

Configurable Ambient Interior Lighting with selectable palette

PERSONALISATION

It becomes your F-TYPE. The choices you make create the car you'll love. Select the body and roof colours that suit you and choose the perfect wheels to complement them. Tailor your personal interior styling, specifying your ideal seats and choosing the textures and colour combinations that will make your F-TYPE unique. With Jaguar's exceptional collection of style-packs, accessories and options your F-TYPE becomes truly bespoke – your ideal sports car – your perfect F-TYPE.



EXPRESS YOURSELF IN COLOUR

STANDARD

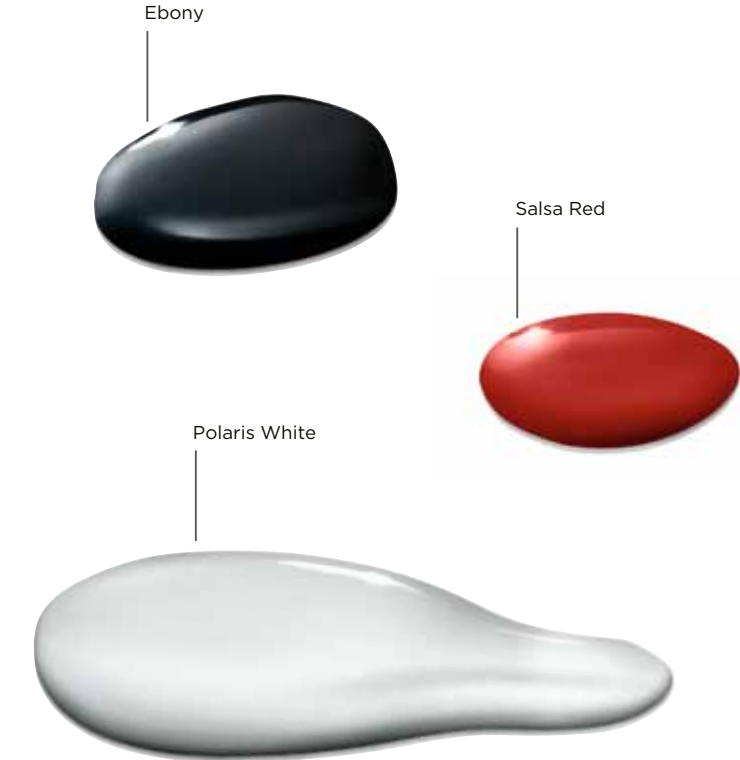

PREMIUM

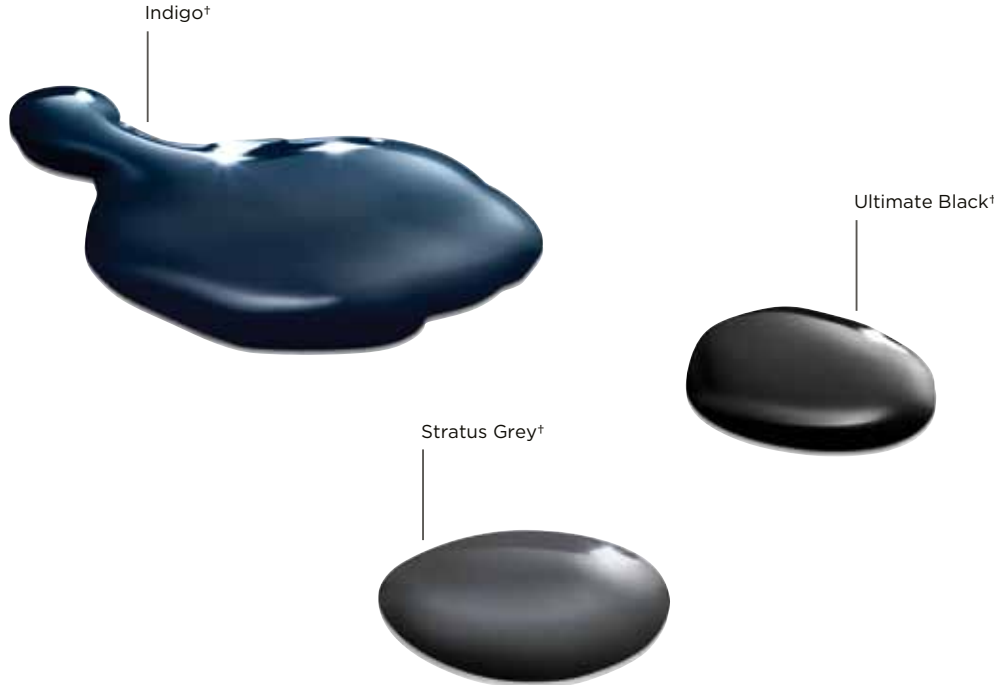

SPECIAL

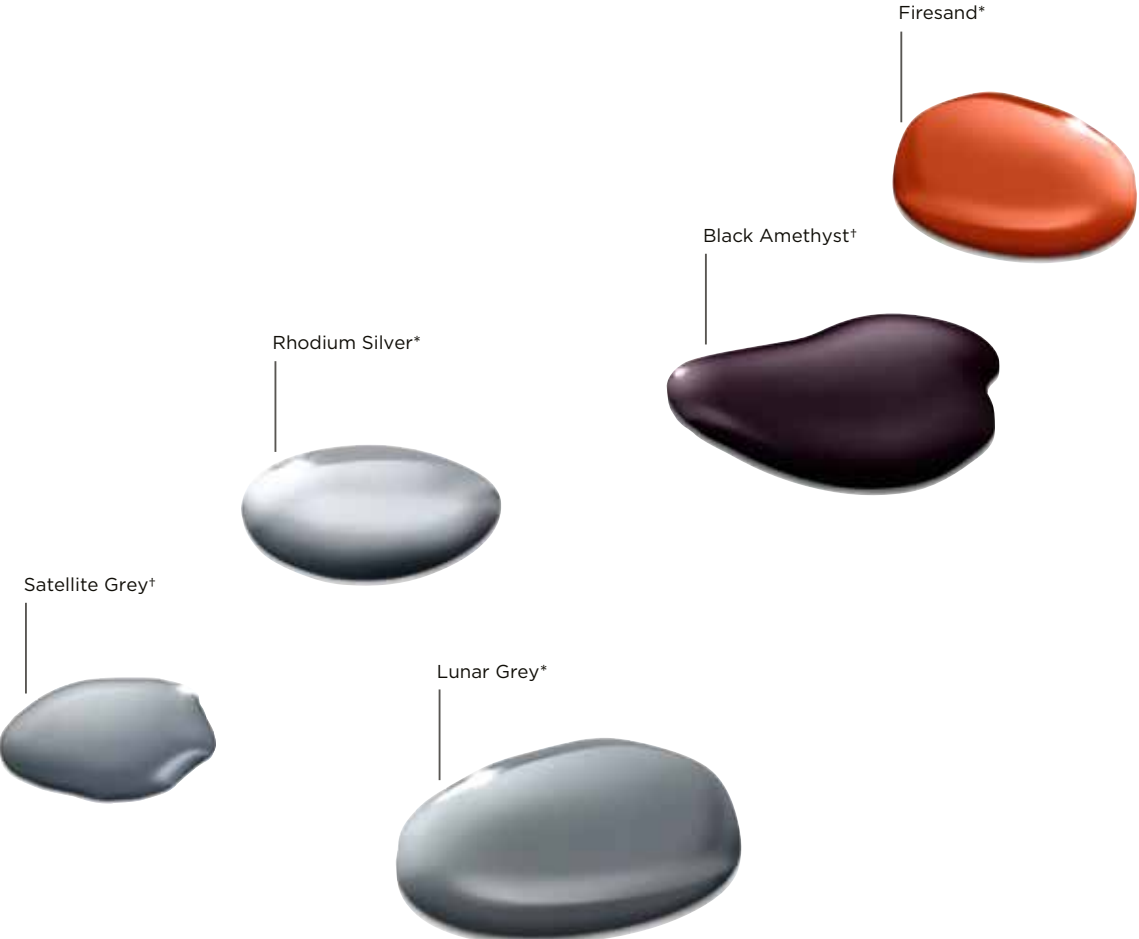

RACE INSPIRED

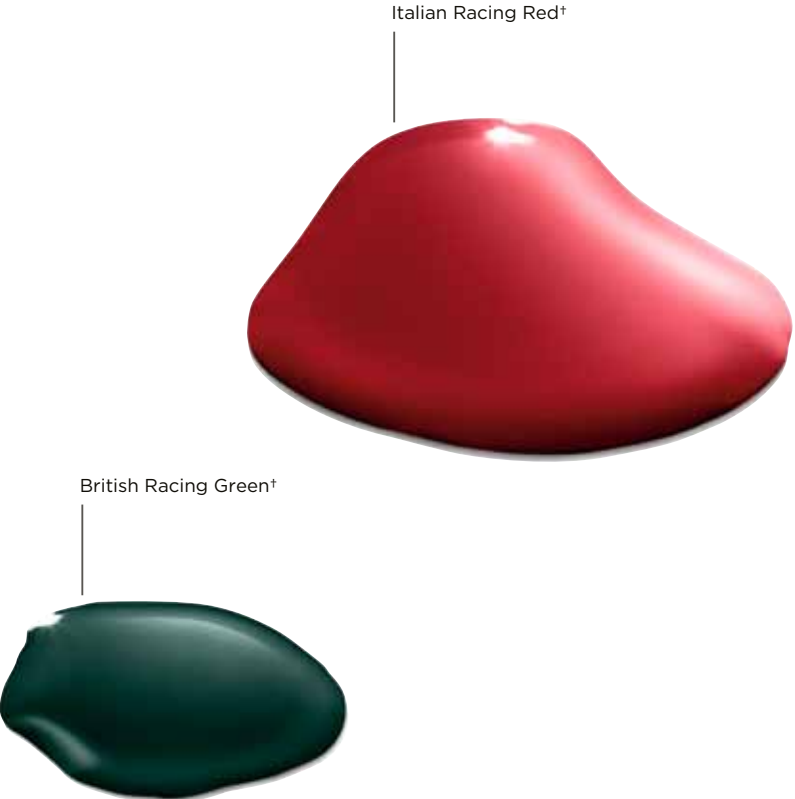

*Metallic paint *Xirallic paint
 Black Pack, Design Pack and Black Design Pack available as an option in Ultimate Black, Polaris White, Italian Racing Red, Rhodium Silver, Firesand and Satellite Grey.
 Also available in other colours as a Dealer Fit Accessory, please contact your local Jaguar dealer for details.

ALLOY WHEELS

Complete your F-TYPE's stunning appearance with the perfect wheels. Your choice of size, alloy or lightweight forged alloy, spoke patterns and finish – Silver, Gloss Black or Carbon Fibre.

18" ALLOY WHEEL



18" VELA SILVER
Standard on F-TYPE

20" ALLOY WHEELS



20" TURBINE SILVER
Standard on F-TYPE V8 S
Optional on F-TYPE and F-TYPE S



20" CYCLONE GLOSS BLACK
Optional on F-TYPE, F-TYPE S and F-TYPE V8 S



20" CYCLONE SILVER
Optional on F-TYPE, F-TYPE S and F-TYPE V8 S

19" ALLOY WHEELS



19" PROPELLER SILVER
Standard on F-TYPE S
Optional on F-TYPE



19" CENTRIFUGE SILVER
Optional on F-TYPE and F-TYPE S



19" CENTRIFUGE GLOSS BLACK
Optional on F-TYPE and F-TYPE S



20" TORNADO SILVER
Optional on F-TYPE, F-TYPE S and F-TYPE V8 S



20" TORNADO GLOSS BLACK
Optional on F-TYPE, F-TYPE S and F-TYPE V8 S



20" BLADE FORGED ALLOY
TECHNICAL GREY/CARBON FIBRE
Optional on F-TYPE, F-TYPE S and F-TYPE V8 S

 Configure your vehicle at F-TYPE.COM

EVEN THE ROOF IS FAST

F-TYPE's fabric roof offers both light weight and refinement with the outer canopy acoustically enhanced with composite fabric and a flush-fitting heated rear window glass. The roof can be raised or lowered in just **12 seconds** and operated fully automatically at speeds of **up to 30 mph**. Its neat, compact stowage keeps the rear of the car low and sleek and avoids the need for a tonneau cover – another weight saving. An optional removable wind deflector can also be fitted between the roll over protection bars.



VEHICLES SHOWN: F-TYPE V8 S IN SALSA RED WITH GLOSS BLACK SIDE POWER VENT ACCESSORY

ROOFS

Jet

Grey

Red

Beige



SEATS

Two seat styles are available on all models, each offering superb comfort and support. On **F-TYPE** the **Sports Seat** with leather and Suedecloth facings is standard. **F-TYPE S** and **F-TYPE V8 S** models gain the added luxury of full leather facings. All models can also be specified with the optional **Performance Seat** which offers enhanced lateral support during rapid cornering, and is upholstered in Premium Leather. Both the Sports and Performance seats feature 4 way electric and 2 way manual adjustment, or 14 way electric adjustment and memory function as an option. They can also be specified with a heated function. For the finishing touch, it is also possible to choose from Jet, Red or Camel seatbelts.

Now you're ready to choose just the right interior colour combination from Jaguar's exclusive collection.



SPORTS SEAT



PERFORMANCE SEAT

SEAT TRIM

Jet leather
(Also available in leather and
Suedecloth, and Premium leather)

Mineral leather
(Also available in leather and
Suedecloth, and Premium leather)

Cirrus leather
(Also available in leather and
Suedecloth, and Premium leather)

Red
Premium leather

Brogue
Premium leather

Camel
Premium leather

Ivory
Premium leather



INTERIOR COLOUR COMBINATIONS

SPORTS SEATS WITH LEATHER AND SUEDECLOTH FACINGS
STANDARD ON F-TYPE

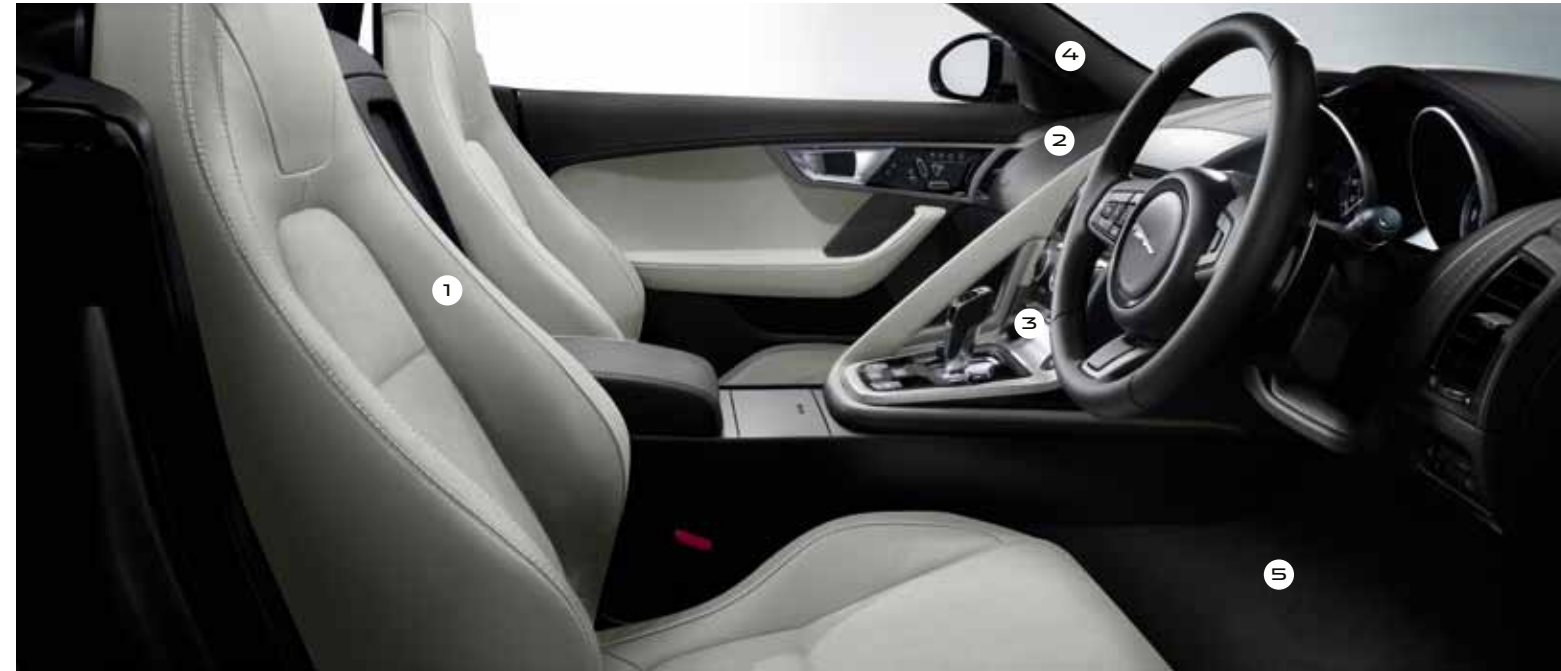

1. Seat with stitch - colour applies to seats, door trim inserts and grab handle.
2. Upper fascia with stitch - colour applies to dashboard, centre console armrest and upper door trims.

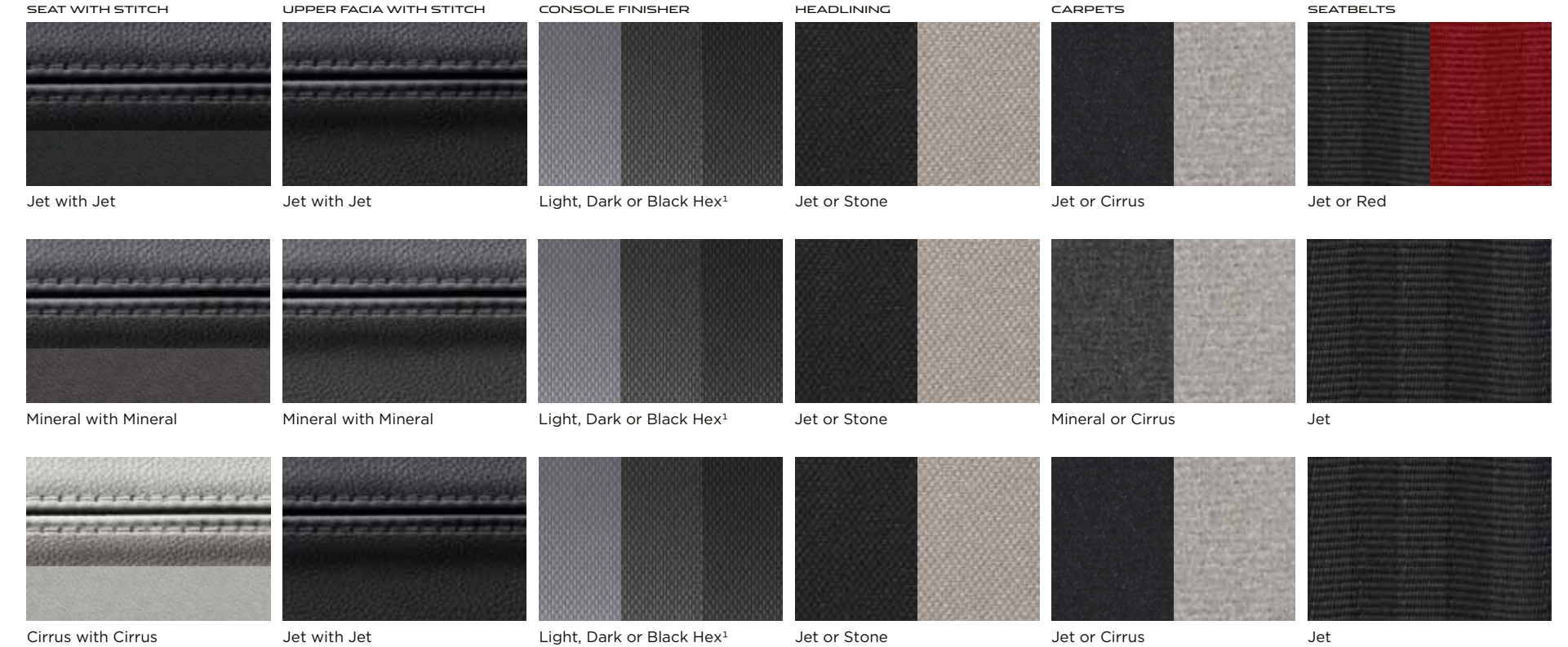

¹Black Hex Aluminium console finisher only available with Interior Black Pack

F-TYPE with Cirrus leather and Suedecloth Sports seats with Jet upper fascia and stitch, Jet Morzine headlining with Light Hex Aluminium console finisher and Jet carpets.

SPORTS SEATS WITH LEATHER FACINGS
 STANDARD ON F-TYPE S AND F-TYPE V8 S, OPTIONAL ON F-TYPE

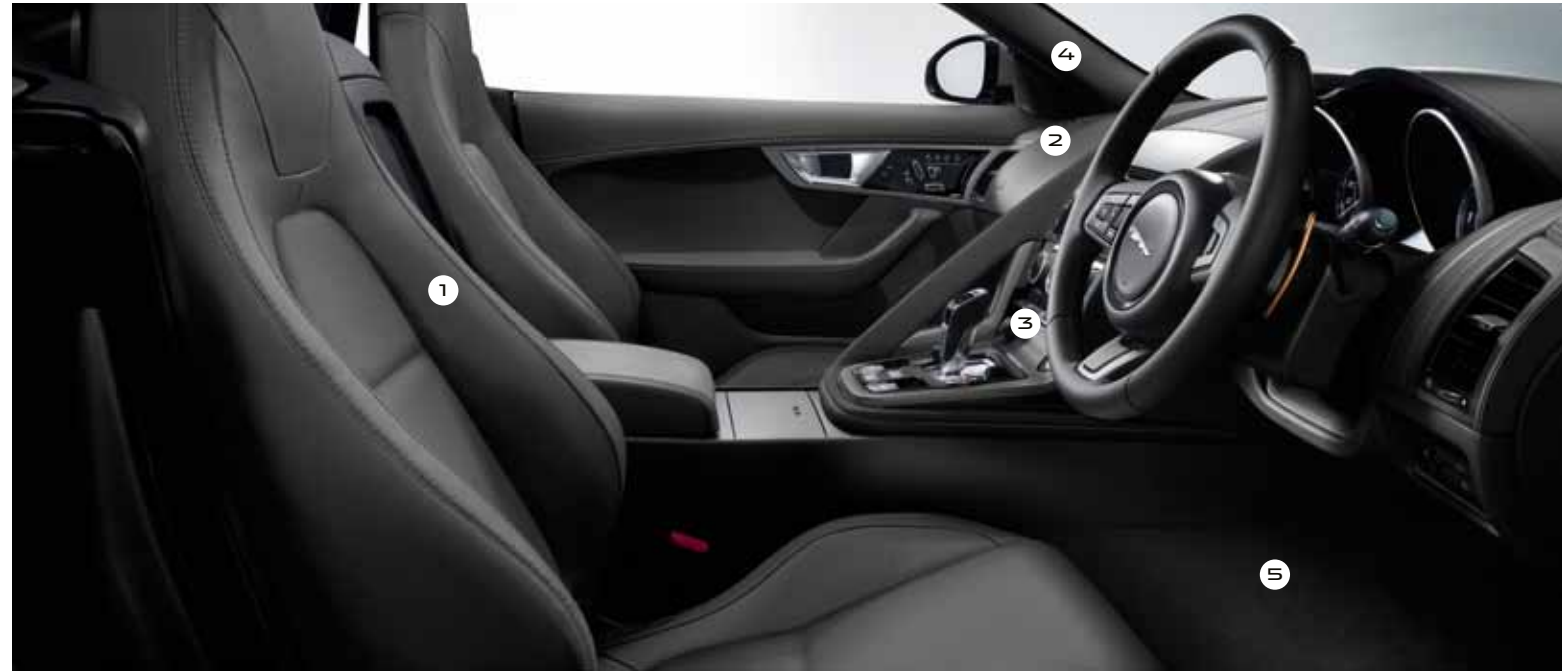

1. Seat with stitch - colour applies to seats, door trim inserts and grab handle.
 2. Upper fascia with stitch - colour applies to dashboard, centre console armrest and upper door trims.

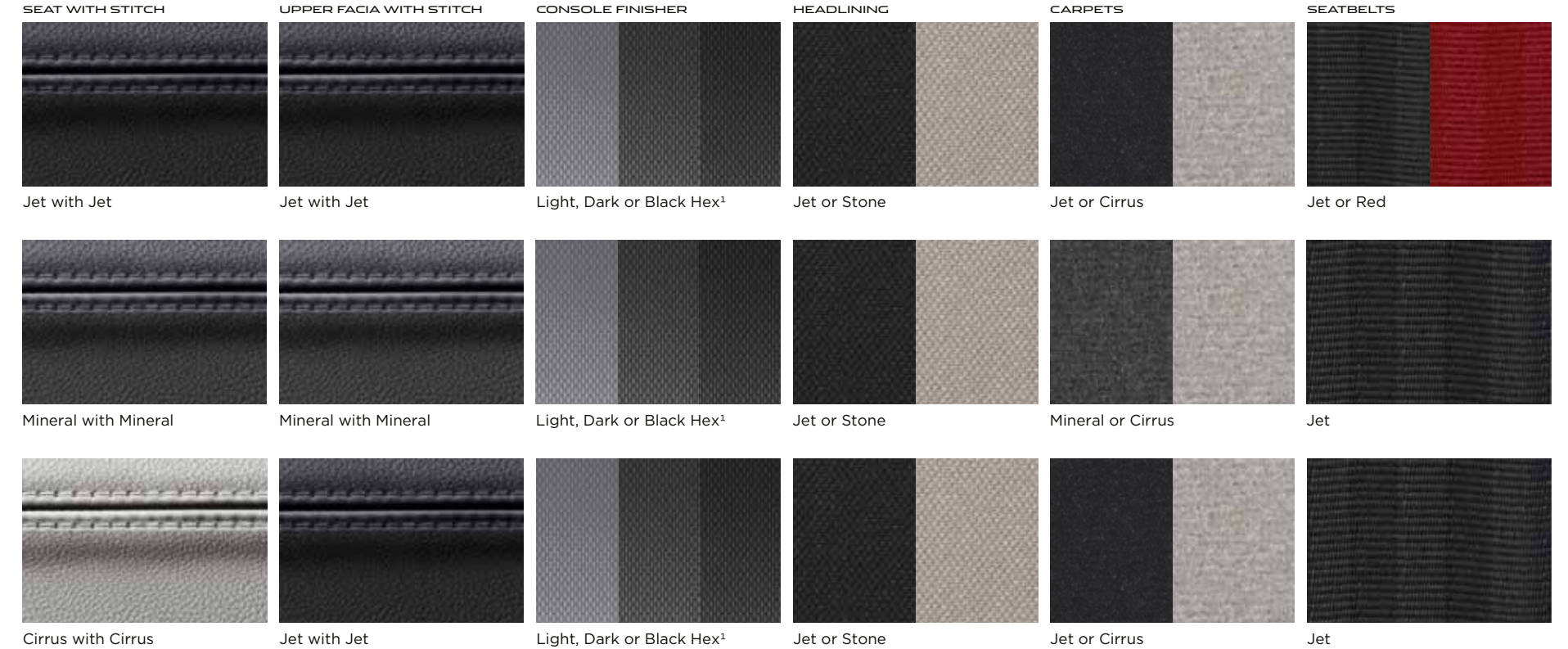

F-TYPE S with Mineral leather Sports seats with Mineral upper fascia and stitch, Jet Morzine headlining with Dark Hex Aluminium console finisher and Jet carpets.

¹Black Hex Aluminium console finisher only available with Interior Black Pack

SPORTS SEATS IN LEATHER WITH PREMIUM LEATHER INTERIOR
 OPTIONAL ON ALL MODELS



1. Seat with stitch - colour applies to seats, door trim inserts and grab handle.
 2. Upper fascia with stitch - colour applies to dashboard, centre console armrest and upper door trims.



F-TYPE S with Jet leather Sports seats with Jet Premium leather upper fascia and stitch, Jet Morzine headlining with Dark Hex Aluminium console finisher and Jet carpets.

¹Black Hex Aluminium console finisher only available with Interior Black Pack
 *Jet Morzine standard and Stone Morzine optional. Leather swatches shown, also available as an option when Extended Leather Pack is selected

PERFORMANCE SEATS IN PREMIUM LEATHER
 OPTIONAL ON ALL MODELS



1. Seat with stitch - colour applies to seats, door trim inserts and grab handle.
 2. Upper fascia with stitch - colour applies to dashboard, centre console armrest and upper door trims.

F-TYPE V8 S with Cirrus Premium leather Performance seats with Jet upper fascia and stitch, Jet Morzine headlining with Dark Hex Aluminium console finisher and Jet carpets.



¹Black Hex Aluminium console finisher only available with Interior Black Pack

PERFORMANCE SEATS IN PREMIUM LEATHER WITH PREMIUM LEATHER INTERIOR
 OPTIONAL ON ALL MODELS



1. Seat with stitch - colour applies to seats, door trim inserts and grab handle.
 2. Upper fascia with stitch - colour applies to dashboard, centre console armrest and upper door trims.

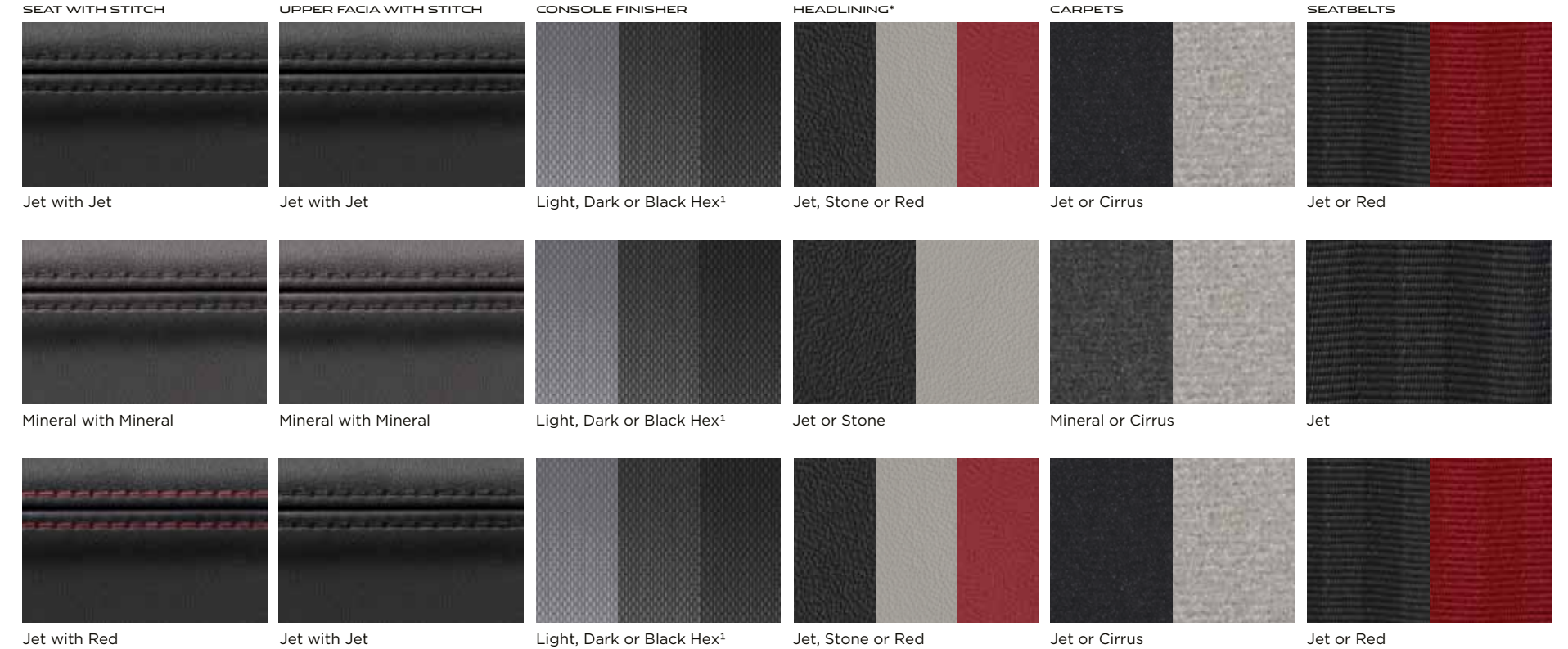

F-TYPE V8 S with Red Premium leather Performance seats with Premium leather interior, Jet leather headlining with Dark Hex Aluminium console finisher and Jet carpets.

¹Black Hex Aluminium console finisher only available with Interior Black Pack
 *Jet Morzine standard and Stone Morzine optional. Leather swatches shown, also available as an option when Extended Leather Pack is selected

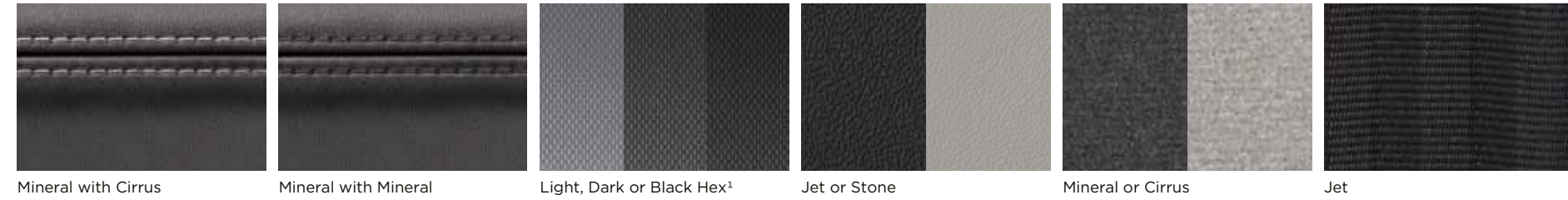
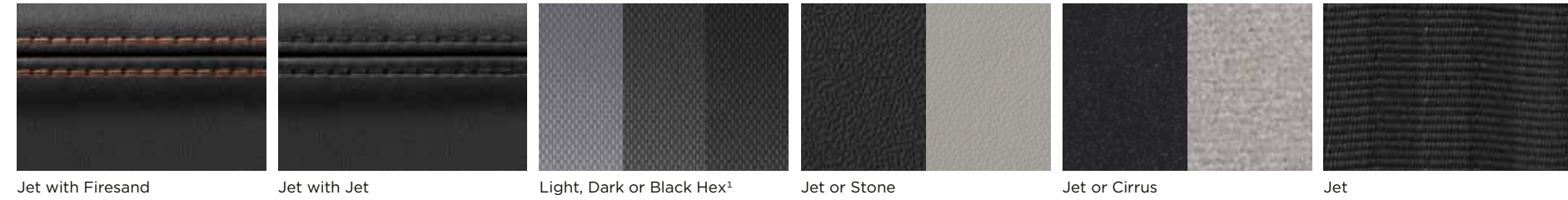
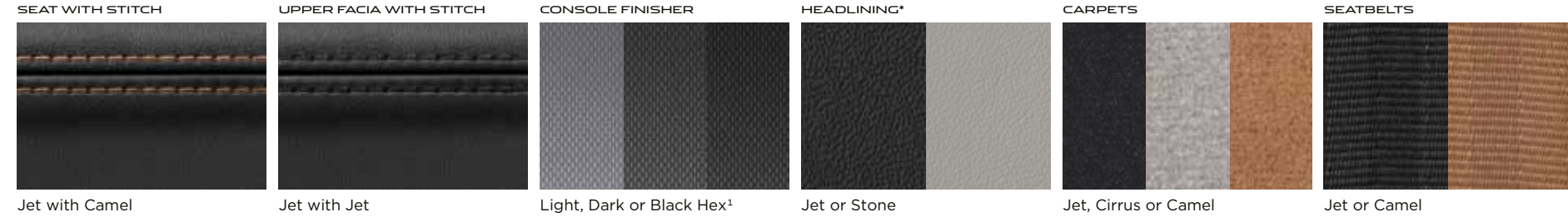

¹Black Hex Aluminium console finisher only available with Interior Black Pack
 *Jet Morzine standard and Stone Morzine optional. Leather swatches shown, also available as an option when Extended Leather Pack is selected

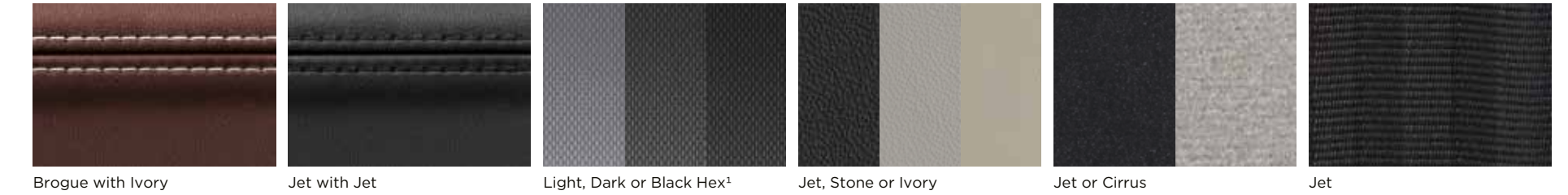
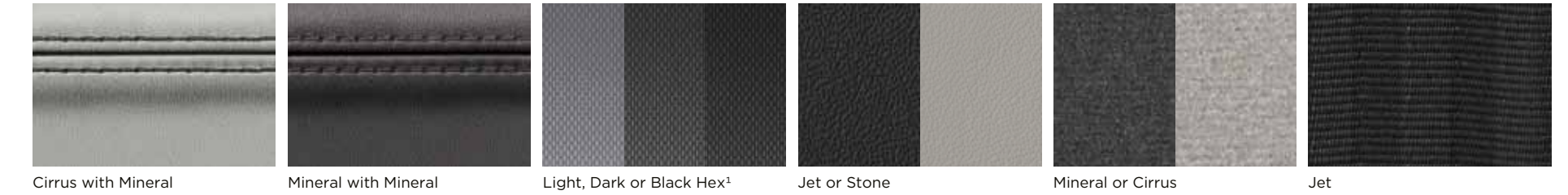
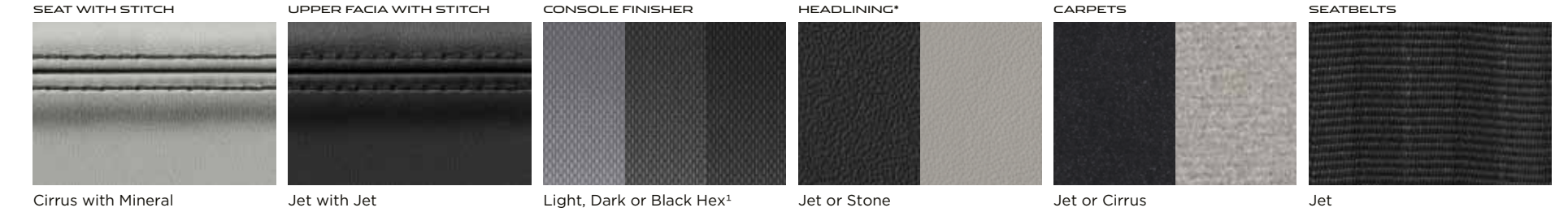

¹Black Hex Aluminium console finisher only available with Interior Black Pack
 *Jet Morzine standard and Stone Morzine optional. Leather swatches shown, also available as an option when Extended Leather Pack is selected

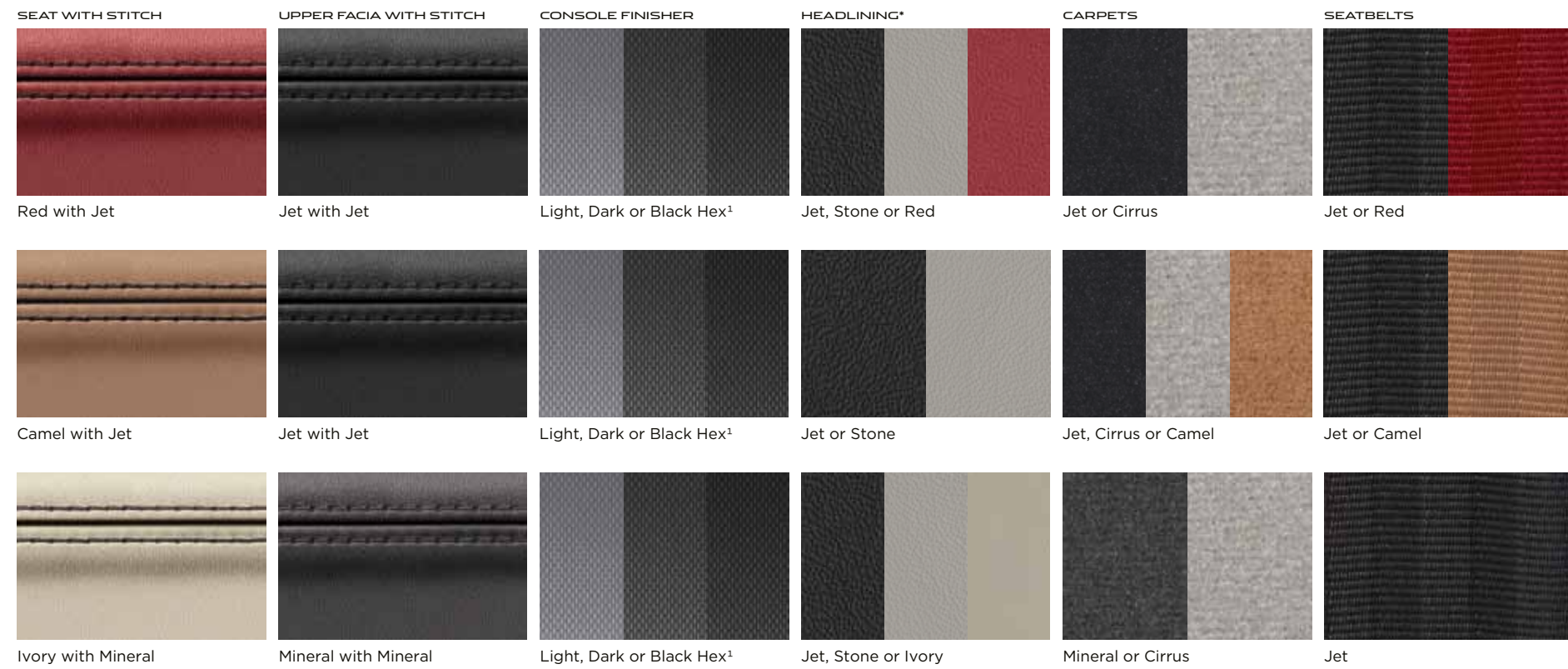

¹Black Hex Aluminium console finisher only available with Interior Black Pack

*Jet Morzine standard and Stone Morzine optional. Leather swatches shown, also available as an option when Extended Leather Pack is selected



VEHICLE SHOWN: F-TYPE S IN SATELLITE GREY WITH PERFORMANCE SEATS AND CARBON FIBRE EXTERIOR ACCESSORIES

ADDED ATTITUDE, ADDED OPTIONS

F-TYPE's strong visual assertiveness can be further enhanced thanks to the availability of two exciting options – **Design Pack** and **Black Pack**. The Design Pack features body-coloured sill extensions, front aerodynamic splitters and a Gloss Black rear valance. It also includes a colour-keyed rear venturi on **F-TYPE** and **F-TYPE S** models and a Satin Black rear venturi on **F-TYPE V8 S**. The Black Pack features a Gloss Black finish on the front grille and surround, as well as to the bumper beam, bonnet louvres and front splitter. The Gloss Black finish also extends to the front outer meshes, side power vents, rear valance and the roll over protection bars.



DESIGN PACK*

1. Body-coloured front bumper splitter **2.** Body-coloured aerodynamic splitters **3.** Body-coloured side sill extensions **4.** Gloss Black rear valance **5.** Body-coloured rear bumper venturi

INTERIOR BLACK PACK

1. Gloss Black air vent surrounds and door switch pack surrounds **2.** Flat-bottomed Sports steering wheel with Gloss Black trim finisher and Ignis paddles **3.** Gloss Black Instrument Cluster Dial Rings **4.** Black Hex Aluminium console finisher

EXTERIOR BLACK PACK*

1. Gloss Black finish to front grille and surround, bumper beam, front splitter and front outer meshes **2.** Gloss Black bonnet louvres **3.** Gloss Black side power vents **4.** Gloss Black rear valance and Roll Over Protection Bars

*Design Pack and Exterior Black Pack limited to Ultimate Black, Polaris White, Italian Racing Red, Rhodium Silver, Firesand and Satellite Grey body colours.

ACCESSORIES

A wide range of high quality accessories is available from your Jaguar dealer. They are all designed to complement your lifestyle, add further individuality or enhance practicality. For the full, extensive collection of F-TYPE accessories, please refer to the Specification and Price Guide.



SUEDECLOTH STEERING WHEEL WITH CARBON FIBRE CENTRE CONSOLE FINISHER

Enjoy the supple touch and stylish look of the luxurious Suedecloth steering wheel.



CARBON FIBRE ENGINE COVER

Add a dynamic flair to your F-TYPE with this lightweight Carbon Fibre cover.



WIND DEFLECTOR

Reduce wind in the cabin with this easy to install, quick to remove, wind deflector.

CARBON FIBRE ROLL OVER PROTECTION BARS

Accentuate your F-TYPE's contemporary sporting style with these Carbon Fibre Roll Over Protection Bars.



20" BLADE FORGED ALLOY TECHNICAL GREY/CARBON FIBRE

Add your own style to your F-TYPE with these striking forged 20 inch wheels. Featuring high-grade Carbon Fibre inserts and Jaguar's dynamic 'Blade' design.



CARBON FIBRE MIRROR COVERS

Accentuate the dynamic design of your F-TYPE's exterior mirrors and add further individuality to its sporting character.



CARBON FIBRE BONNET LOUVRES

Emphasise one of your F-TYPE's most distinctive features with these high-grade Carbon Fibre Bonnet Louvres.

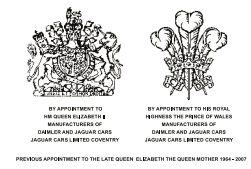

IMPORTANT NOTICE

Jaguar Cars Limited is constantly seeking ways to improve the specification, design and production of its vehicles and alterations take place continually. Whilst every effort is made to produce up to date literature, this brochure should not be regarded as an infallible guide to current specification, nor does it constitute an offer for the sale of any particular vehicle. Distributors and dealers are not agents of Jaguar Cars Limited by any express or implied undertaking or representation.

ENVIRONMENTAL INNOVATION AT JAGUAR

Jaguar is proud to continue the company's tradition with its approach to Environmental Innovation. From the choice of lightweight materials and lean production methods to the efficiency of its engines and designs, Jaguar is committed to operating as a more sustainable business and reducing its overall environmental impact.

Jaguar's flagship XJ model was the first in the company to achieve ISO 14040, the international standard for vehicle 'whole life cycle' assessment. This certification measures the environmental impact of XJ from component material sourcing and manufacturing process, through its driven life time, to final disposal. But that's not all. Every new Jaguar vehicle is designed to be 85% recyclable and reusable, in addition 95% recoverable and reusable with 10% potentially for energy generation.

The XJ, F-TYPE and XK's innovative use of lightweight aluminium, which incorporates up to 50% recycled material from the manufacturing process in the body structure, provides considerable performance benefits. This includes improved fuel consumption, and less CO₂ emissions as well as the dynamic performance inherent in its weight saving design.

Jaguar is committed to reducing dependency on fossil fuels, using fewer resources and creating less waste. Already the manufacturing assembly CO₂ emissions of each Jaguar built in the UK since 2009 is offset. For every tonne of CO₂ emitted in the assembly process, Jaguar invests in carbon reduction projects that reduce an equivalent tonne of CO₂ elsewhere.

Offsetting allows Jaguar to take action now, to reduce its impact on the environment, as part of an integrated carbon management plan. The company plan includes targets to reduce operating CO₂ emissions and waste to landfill by 25% by March 2013 and European fleet average tailpipe CO₂ emissions by 25% by 2015. All targets are based on 2007 levels.

But it doesn't stop there. We have been awarded Platinum status in the Corporate Responsibility Index 2012 from the UK's Business in the Community, in recognition of our 360 degree approach to sustainable development.

That's Environmental Innovation at Jaguar.

VEHICLE SHOWN: F-TYPE S IN SATELLITE GREY

'Trifold™' and the 'three fields' device are trademarks of Trifold Productions Ltd.
iPod, iPod touch and iPad are trademarks of Apple Inc., registered in the U.S. and other countries.



Jaguar Cars Limited,
Registered Office: Abbey Road, Whitley,
Coventry, CV3 4LF, United Kingdom
Registered in England Number: 1672070
jaguar.co.uk



