



SHIFT_

NISSAN

PRIMASTAR Euro 5



[Contents](#) | [Exterior design](#) | [Interior design](#) | [Technology & Performance](#) | [Style & Accessories](#) | [Technical specifications](#) | [Price List](#) | [Commitments](#)

[Print](#) | [Close](#)

[REQUEST A TEST DRIVE](#)





LOOK & FEEL

PRESENTATION	4
EXTERIOR DESIGN	6
INTERIOR DESIGN	8

TECHNOLOGY & PERFORMANCE

ENGINE EFFICIENCY	10
SAFETY & SECURITY	12
COST MANAGEMENT	14
LOAD SPACE	16
MINIBUS	20

STYLE & ACCESSORIES

FEATURES & OPTIONS	22
BODY STYLES	30
DIMENSIONS	32
COLOURS/TRIMS/WHEELS	34
ACCESSORIES	36
ALL ABOUT NISSAN	38

INTRODUCING NISSAN PRIMASTAR

CHOOSE A MOBILE BUSINESS SOLUTION THAT'S SIZED AROUND YOU. NISSAN PRIMASTAR MULTI-OPTION LCVS DELIVER ALL THE SPACE, COMFORT AND COST-EFFICIENCY YOU NEED TO DRIVE YOUR INTITATIVES FORWARD.

www.nissan.co.uk and www.nissan-lcv.co.uk



The PRIMASTAR range offers such an extensive choice that it's easy to create a vehicle that exactly suits your needs. The Van is available in two lengths and two heights, to match your daily cargo needs. The Good to Go conversion programme gives you further options with a six seat Crew van and Freezer or Chiller van.



BUILT AROUND YOU

The Minibus, also available in two lengths, takes loads plus workmates or passengers with ease. With a choice of engines, up to three grades and numerous options, you can see how PRIMASTAR is the ultimate made-to-measure business vehicle.



8.4 M³
MAXIMUM FLEXIBLE LOAD SPACE

1,282 KG
MAXIMUM PAYLOAD

115 HP

3-YEAR
WARRANTY



⁴
LOOK & FEEL

⁵
PRESENTATION

[Contents](#) | [Exterior design](#) | [Interior design](#) | [Technology & Performance](#) | [Style & Accessories](#) | [Technical specifications](#) | [Price List](#) | [Commitments](#)

[Print](#) | [Close](#)

[Page 1](#) | [Page 2](#)

[REQUEST A TEST DRIVE](#)



IMPRESSIVE DESIGN



6
LOOK & FEEL



ENHANCE YOUR STATUS

Driving a PRIMASTAR immediately conveys a powerful, positive impression. Its thoroughly modern design and attractive yet practical features, conveys a message of strength and efficiency to the outside world. With even greater attention to detail and quality, choosing PRIMASTAR proves your shrewd judgement.

The new front design incorporates combined headlamps and indicators that ensure you can see and be seen more easily – a benefit that also applies to the new rear lights. A larger rear bumper provides increased protection against every day knocks. With different paint treatments for the bumpers and body mouldings, the Van and Minibus have clearly individual identities that set them – and you – apart on the road and in the car park.



7
EXTERIOR DESIGN

[Contents](#) | [Exterior design](#) | [Interior design](#) | [Technology & Performance](#) | [Style & Accessories](#) | [Technical specifications](#) | [Price List](#) | [Commitments](#)

[Print](#) | [Close](#)

[Page 1](#) | [Page 2](#)

[REQUEST A TEST DRIVE](#)





USER-FRIENDLY TECHNOLOGY

THE COMFORT ZONE

Inside, PRIMASTAR feels more like a car than a van. The high quality trim is smart and inviting, again with three distinct finishes for the Van, and Minibus. Even more impressive is the level of equipment available to make driving easy and more comfortable.

The dashboard design features extra, practical storage spaces and a new range of audio systems featuring Bluetooth® for hands-free phone use, remote controls and convenient auxiliary input for your iPod and MP3 players.



Driver-friendly technology available for PRIMASTAR includes automatic wipers with speed adaptive function, automatic lighting with friendly lighting function, rear parking sensors, air conditioning, cruise control. You can also have a 3-button key, which lets you lock and unlock the front and cargo doors separately

Climate control replaced by Manual air conditioning in UK

[REQUEST A TEST DRIVE](#)





HIGHER EFFICIENCY

PRIMASTAR's wide range of engines ensure easy load hauling ability, quiet cruising and responsive acceleration. All versions are equipped with a 6 speed manual gearbox and as an option you can specify the 6 speed semi-automatic transmission which helps to reduce wear on your transmission as well as giving you an easier drive in congested stop-start conditions.

LOWER ENVIRONMENTAL IMPACT

With long maintenance intervals for lower running costs, and improved environmental responsibility, the new engine range makes driving PRIMASTAR feel even better.

2 TYPES OF TRANSMISSION
115HP



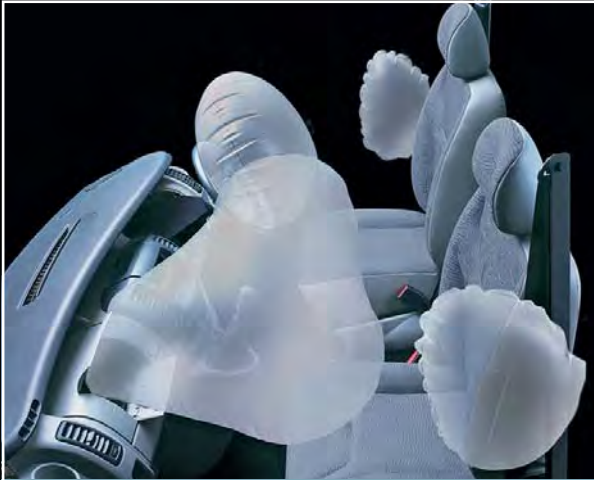

AGILE AND TOUGH

Accidents and incidents happen suddenly and without warning. Fortunately, PRIMASTAR is designed to respond rapidly and decisively to your control. With all-wheel disc brakes, EBD (Electronic Brake force Distribution) and standard ABS and EBA (Emergency Brake Assistance), PRIMASTAR has one of the shortest stopping distances in its class. The optional ESP (Electronic Stability Program) further supplements PRIMASTAR's agile handling during routine driving and in the event of emergencies.

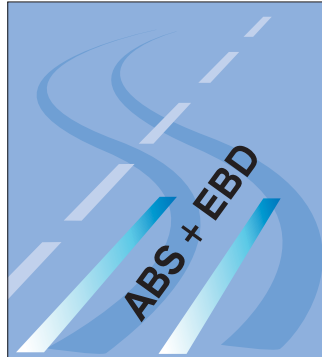

ABS & EBA EBD ESP

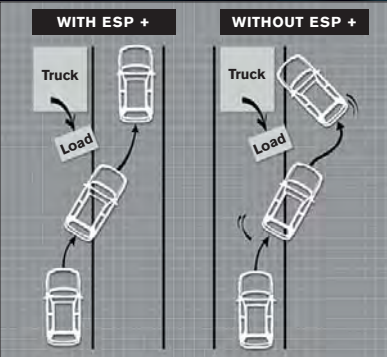

The tough reinforced cabin structure provides maximum protection in case of accident, whereas seatbelts with pretensioners and load limiters combined with airbags for driver and optionally for passenger, complete the safety equipment of PRIMASTAR. In addition, the passenger airbag can be deactivated if you need to carry a child seat. The rain sensor provides extra safety where specified. Set the wiper switch to the rain sensor function and they'll be activated automatically whenever they're needed, while the speed adaptive feature will vary their frequency according to PRIMASTAR's road speed. This improves visibility and leaves you free to concentrate. And as an extra precaution, the doors lock automatically when you reach 5mph.





14
TECHNOLOGY & PERFORMANCE

A TRUSTED WORKER



With its renowned Nissan reliability, it might seem that all you have to do with PRIMASTAR is keep it clean. You can certainly drive a long way between service appointments, with up to 18,000 between services.

The latest PRIMASTAR has a 3-year, 100,000 mile warranty, 6-year paint warranty and 12-year anti-corrosion warranty, PRIMASTAR is designed for easy repair – keeping your maintenance and insurance costs low. So it's just as well that this dependable, desirable vehicle is protected by an alarm system and immobiliser.



LOW COST OF OWNERSHIP LONG SERVICE INTERVALS

15
COST MANAGEMENT

[REQUEST A TEST DRIVE](#)



Load space is understandably one of the vital considerations when you're choosing a van. PRIMASTAR takes an impressive amount of cargo: up to 1,240kg payload for the SWB van in either height, with 5m³ of usable volume, up to 7.1m³ for the taller version.

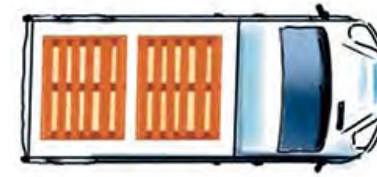

VAN L1H1
The shorter PRIMASTAR
can load 2 Euro-pallets

EASY TO LOAD, HARD TO FILL



PRIMASTAR helps you make the most of all that space. With 1m wide sliding side doors available on both sides and a low floor, it's easy to load the 2.4m long cargo deck (2.8m long in the LWB version). To make sure your loads are properly secure, there plenty of anchorage points on the floor and all points are reinforced for extra strength.





VAN L2H2
The bigger PRIMASTAR
was designed to load up to
3 Euro-pallets

8.4 M³
MAXIMUM LOAD SPACE



16
TECHNOLOGY & PERFORMANCE

[Contents](#) | [Exterior design](#) | [Interior design](#) | [Technology & Performance](#) | [Style & Accessories](#) | [Technical specifications](#) | [Price List](#) | [Commitments](#)

[Print](#) | [Close](#)

[Page 1](#) | [Page 2](#) | [Page 3](#) | [Page 4](#) | [Page 5](#) | [Page 6](#) | [Page 7](#)

[REQUEST A TEST DRIVE](#)



TAKE ON MORE

Long loads can be awkward to carry – unless, of course, you have a long wheelbase PRIMASTAR. 2.8m internal length and a 1,200kg payload means you can accommodate carpets, timber, pipes – whatever the day's challenging load might be. That's 5.9m³ of usable space or a vast 8.4m³ for the taller van.



With the long version PRIMASTAR, in either height, you can specify rear doors that open 250°, folding flat right against the sides of the van to give you totally unimpeded loading access.



2,800MM LONG
LOAD FLOOR

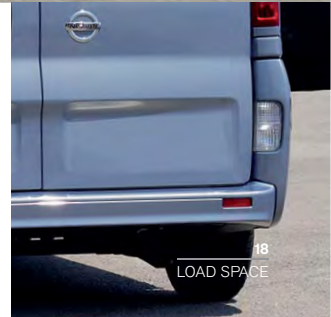

MINIBUS: YOU WIN AGAIN



The Minibus is available in two lengths. The standard version (L1) seats nine people with nearly 0.45m for loads, or if you fold down the rear seat, six people with over 1.5m of load space length. Choose the long wheelbase version (L2), and those cargo lengths increase to nearly 1.2m and over 1.9m respectively, while the load volume goes up from 1.2m³ to 4m³. And you can completely remove the third row and fold the second row for maximum load carrying when you need it. The load space incorporates four anchorage points, ready for attaching an optional cargo net.

With the PRIMASTAR Minibus you win both ways, with space to carry your workmates and their tools or your sports team and their kit. Entry and exit is easy with sliding doors on both sides. The Minibus is well appointed and comfortable; all seats have headrests and 3-point seatbelts and with optional air conditioning, you can maintain your preferred temperature throughout your journey. Yet it's still practical and durable enough to withstand the knocks that inevitably come from carrying equipment everyday.

PRIMASTAR is also available as a 6 seat Crew van with a secure load space separated from the cabin by a full bulkhead.

19
TECHNOLOGY & PERFORMANCE

9
SEATS
4M³
FLEXIBLE LOAD SPACE

20
MINIBUS

[Contents](#) | [Exterior design](#) | [Interior design](#) | [Technology & Performance](#) | [Style & Accessories](#) | [Technical specifications](#) | [Price List](#) | [Commitments](#)

[Print](#) | [Close](#)

[Page 1](#) | [Page 2](#) | [Page 3](#) | [Page 4](#) | [Page 5](#) | [Page 6](#) | [Page 7](#)

REQUEST A TEST DRIVE

REDUCE YOUR WORK LOAD

With an exceptional choice of driver-friendly equipment available, PRIMASTAR leaves you free to concentrate on the road and on your business.



21
STYLE & ACCESSORIES



SPEED LIMITER AND CRUISE CONTROL

This feature on SE+ models helps you comply with the law, avoid speeding tickets and make light work of long journeys, by maintaining any speed you choose above 20 mph. Press the + or - buttons on the steering wheel to set your chosen speed (displayed on the dashboard). PRIMASTAR stays at this speed and won't exceed it, unless you push hard on the accelerator. Using the accelerator or the brake immediately overrides the system, making sure you always retain full control.

THREE-BUTTON KEY

This remote central locking key lets you lock and unlock doors selectively. You can choose to lock or unlock the front doors only, or the loading area separately, including side and rear doors. For optimum convenience, you can also lock or unlock all doors at a time.

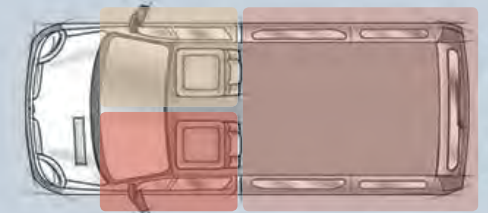

RAIN SENSING AND SPEED ADAPTIVE WIPERS

The wipers are automatically activated by rain on the windscreen, and adapt to the amount of rain and to PRIMASTAR's speed. Below 3mph, the wipers revert to the next lowest setting, e.g. from continuous to intermittent. This is especially helpful in stop-start city driving, leaving you free to keep your hands on the wheel.

AUTOMATIC LIGHTING

As long as the engine is running (and you've switched on the function), dipped headlights will switch on automatically when the sensor detects that the ambient light requires them. Another innovation that reduces your workload, particularly when conditions are deteriorating.

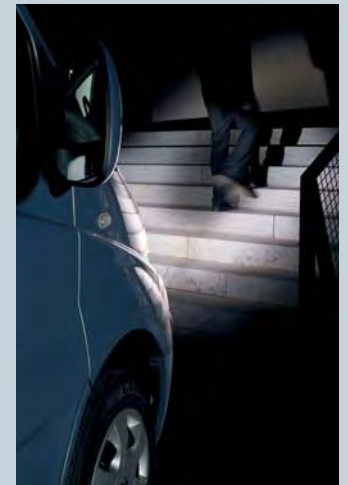

FRIENDLY LIGHTING

This feature is really helpful if you're making deliveries at night. When the engine's turned off, pull the headlamp stalk briefly to the flash setting, and the headlights will stay on for 30 seconds. You can pull the stalk up to four times, giving you as long as 2 minutes – usually plenty of time to find your way.

22
FEATURES & OPTIONS

REDUCE YOUR WORK LOAD



REAR PARKING SENSOR

On all PRIMASTAR SE and SE+ models, this feature means you can be confident that you won't damage your PRIMASTAR or any person or object behind it. Operating automatically when you engage reverse, the system emits a beep which becomes more frequent the closer you are to the object behind. When the beep is continuous, it's time to stop! The sensors are specially designed for PRIMASTAR's low loading sill and can be turned off if you're towing a trailer.

AIR CONDITIONING

The manual air conditioning system is an option on SE models and is standard on SE+ versions, helping you to enjoy a comfortable drive.



ONE TOUCH POWER WINDOWS

The electric windows will raise or lower with only one firm touch of the button – useful at barriers as your hand can go straight back to the steering wheel.



REINFORCED ANTITHEFT SYSTEM

To safeguard your goods, tools and personal items, PRIMASTAR offers a well-designed security system with protected keyholes and reinforced door locks. The security encoded key makes it virtually impossible to unlock the vehicle using any other key, and the optional built-in alarm will sound if any attempt is made to force a way in.



AUDIO RANGE

The audio range includes CD radio with an aux input jack for your MP3 player as standard equipment on all models. To make your life easier the remote audio controls allow you to operate the audio system without taking your hands off the wheel.



AUTOMATIC DOOR LOCK WHILE DRIVING

To keep you and your loads secure, all the doors lock automatically when PRIMASTAR goes above 8km/hr.

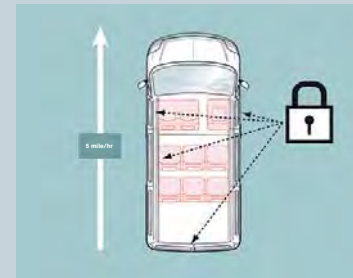

BLUETOOTH®

Bluetooth® is a practical, convenient way to link your mobile phone wirelessly to PRIMASTAR's audio system, so you can stay in touch at all times. You can take and make calls hands free*, and browse your phonebook contacts via the audio system's display. Bluetooth® can also play music from your compatible MP3 player or MP3 phone via streaming audio.

*For greater safety, we recommend you stop to make phone calls.



AUDIO AND PHONE REMOTE CONTROL

For extra convenience and safety you can control the main functions of the audio system, such as volume, source and track selection, using this steering column-mounted switch. If you have a Bluetooth®-enabled phone, you can use the same switch to start and stop calls. All without taking your hands from the steering wheel.

TACHOGRAPH

To help you comply with legislation, an advanced digital tachograph is available as an option separate smart card readers for two drivers and the ability to use a company smart card to transfer data between the tachograph and a PC. The comprehensive information display includes driver activity, time and distance, and the integrated printer can produce reports for instant checking.

THE PERFECT FIT

PRIMASTAR's many features and options have been designed with real business needs in mind. So if you have special requirements it's most likely that PRIMASTAR can satisfy them.



TUBULAR BULKHEAD

COAT HANGER
This useful coat hanger is ideally located on the bulkhead.



GLAZED BULKHEAD

BULKHEADS
A tubular bulkhead is standard on E grade vans and provides protection for the driver from sliding loads, while still allowing access from the front passenger seats to the load space. For your safety and the security of your goods SE and SE+ models have a full steel bulkhead for optimum load protection and increased comfort for everyday use by effectively reducing noise.

SOLID BULKHEAD



EXTRA ELECTRICAL CAPACITY
If you frequently use electrical accessories such as a portable navigation system, a phone kit or a DVD player for your children, it's worth having the peace of mind of PRIMASTAR's 'heavy duty' system. It provides either 85Ah or 95Ah for high-demand situations.



SECOND BATTERY RACK
If you frequently need a power supply when the engine's not running (for example, if you want to run a refrigeration unit) a second battery rack is available to house an independent power supply. This option provides the rack only, allowing you to choose the battery based on your particular application.



TWO SLIDING DOORS
Sliding doors help you access your loads more easily. They are available for both sides of the PRIMASTAR Van and are offered for the standard and long wheelbase Minibus, greatly increasing your passengers' comfort and your loading options.



ADDITIONAL ANCHORAGE POINTS
Two anchorage points on the load space floor help keep your cargo safe and secure, complementing the anchorage points on the body sides. The hooks have been designed to withstand loads of up to 625kg.



12 V MULTI-PURPOSE SOCKET
A 12V socket is conveniently located on the central dashboard so you can recharge your mobile phone, your PDA or your laptop (using the special adapters required by your device). In the Minibus, passengers can benefit from a second 12V socket located on the side wall between the second and third row of seats.



HEATING SYSTEM
The heating system now distributes warm air directly to your feet and can supply considerably more heat to the rear of the vehicle. This is particularly useful for keeping all the passengers comfortable and happy in your PRIMASTAR Minibus.



27
STYLE & ACCESSORIES



28
FEATURES & OPTIONS

[REQUEST A TEST DRIVE](#)



BODY STYLES

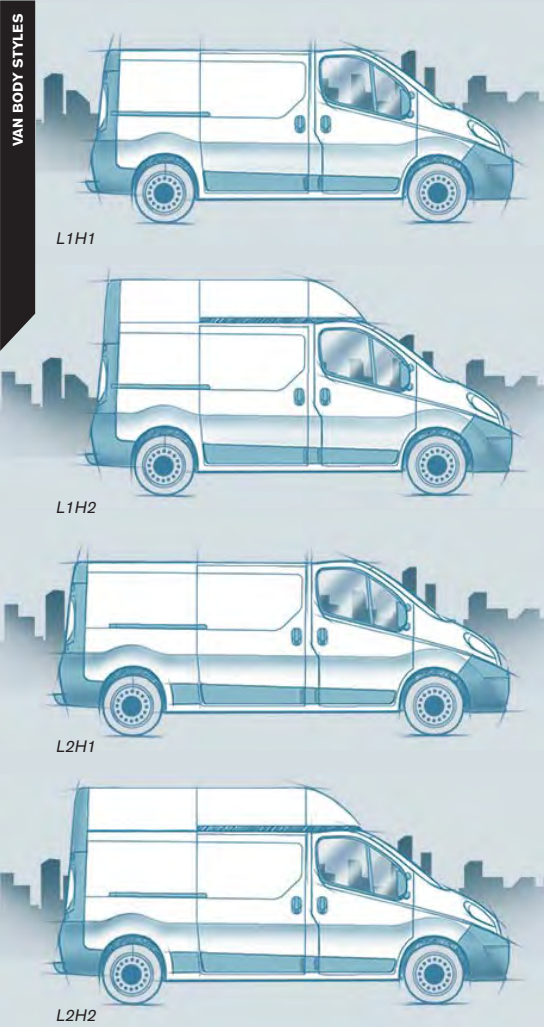

Choose which PRIMASTAR your business needs: Van or Minibus. Then you can choose from two lengths, two heights and details such as glazed or panel side doors, hinged solid or glazed rear doors or glazed tailgate.

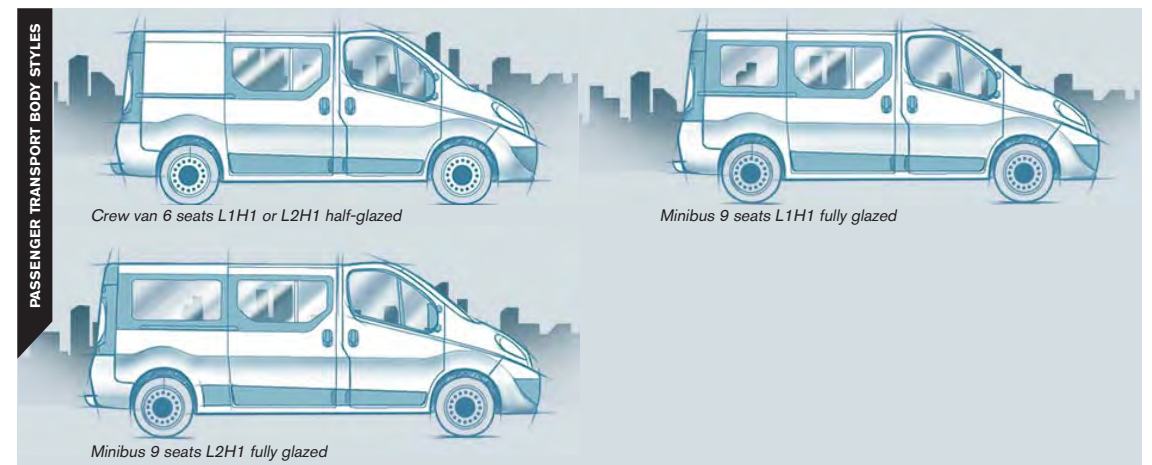
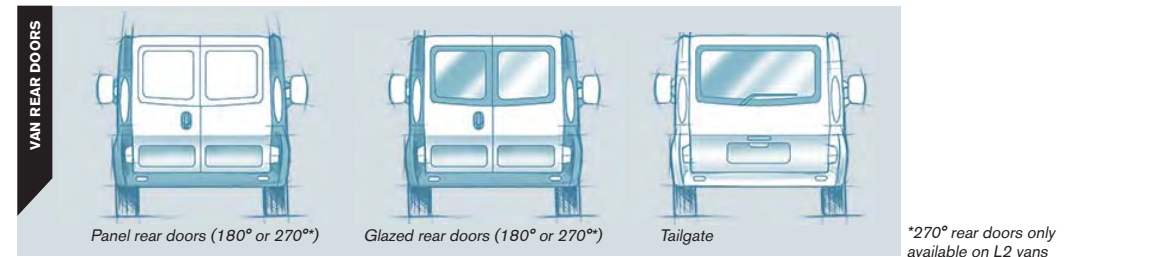
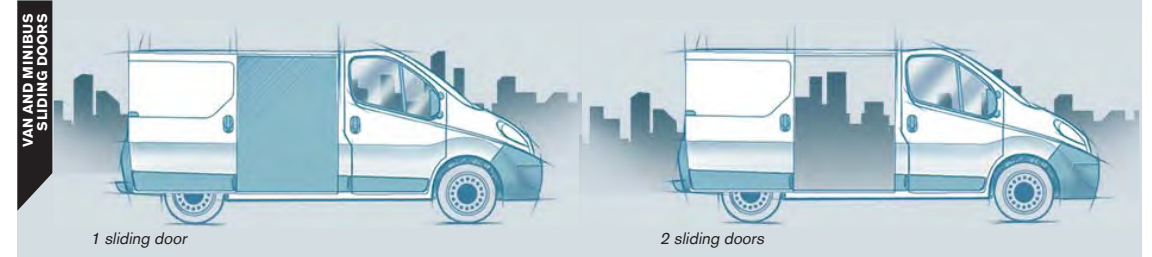
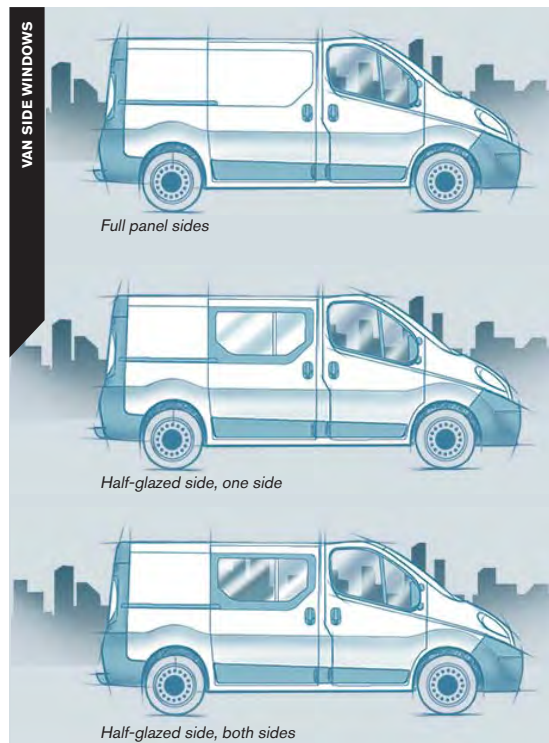

L1 = SWB, L2 = LWB

DIMENSIONS

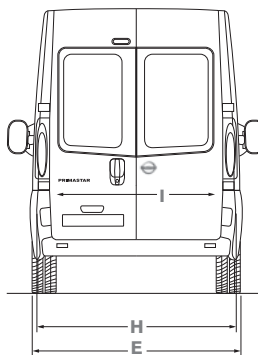
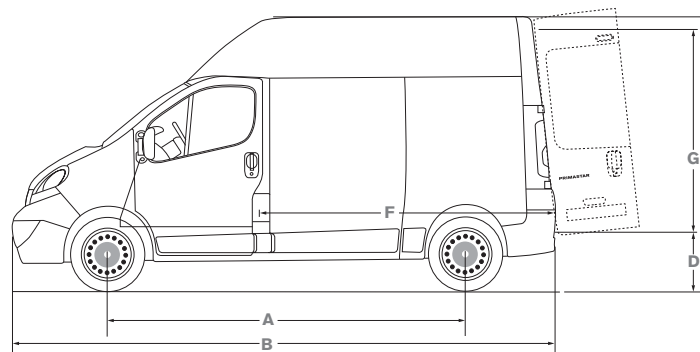
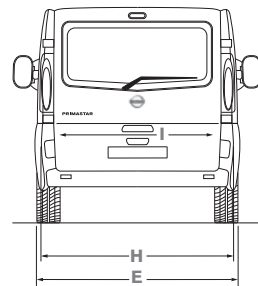
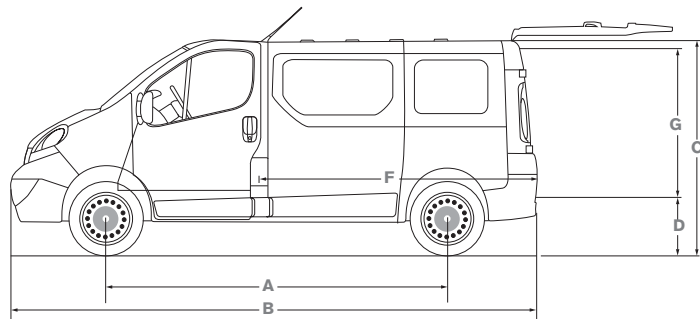
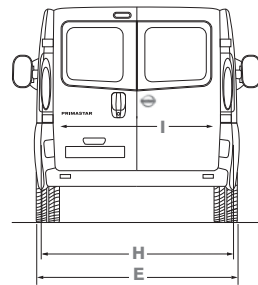
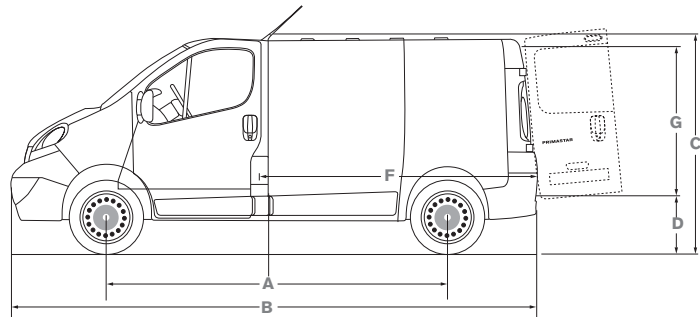

PRIMASTAR's compact external dimensions make it manoeuvrable for busy streets and let you slip into parking spaces other vans have to drive past. Yet highly efficient design ensures that, inside, PRIMASTAR offers a great deal of space.

Dimensions (mm)		VAN				MINIBUS			
		L1H1	L1H2	L2H1	L2H2	L1H1		L2H1	
						6 seats	9 seats	6 seats	9 seats
Wheelbase	A	3,098		3,498		3,098		3,498	
Overall Length	B	4,782		5,182		4,782		5,182	
Overall Height	C	1,955 [*] /1,963 ^{**}	2,465	1,962	2,464	1,952		1,956	
Load platform Height	D	534	527	533	525	540	535	538	532
Overall Width	E	1,904				1,904			
Cargo Length	F	2,400		2,800		1,548	790	1,948	1,190
Cargo Height	G	1,387	1,913	1,387	1,913	1,369			
Cargo Width	H	1,690				1,678			
Width between wheel arches	I	1,268				1,234			

* 1,000 kg payload models;

**1,200 kg payload models.

COLOURS

UPHOLSTERY

METALLIC / M SOLID / S



Polar White
Z36 / S



Furnace Red
Z35 / S



Delta Blue
Z39 / S



Solar Yellow
Z37 / S



Universe Black
Z41 / M



Steel Grey
AR0 / M



Hydra Green
Z42 / M



Ocean Blue
ZT4 / M

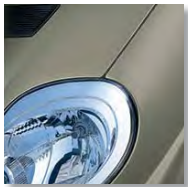

Beige Grey
ZT1 / M



Mercury Silver
Z34 / M

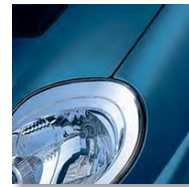

Panorama Blue
ZW6 / M



Storm Blue
ZBH / M

Seat trim Van and Minibus

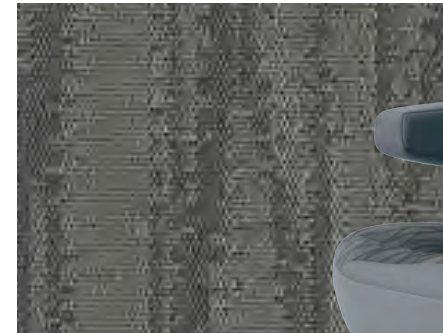

WHEELS



Standard steel wheel trim

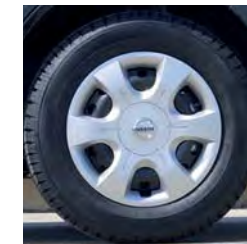

Full wheel trim - SE+



01

PRIMASTAR ACCESSORIES

Our range of genuine accessories is the logical extension of PRIMASTAR's versatility. With these special accessories, you can precisely equip your vehicle for its intended role, knowing that the extras you choose are strongly made and specifically designed to enhance your PRIMASTAR.

Featured accessories:

- 02: Mudguards
- 03: Removable towbar
- 04: Microline window protection



04

36
ACCESSORIES

Featured accessories:

- 01: The PRIMASTAR van accessorised with roof rack, roof rack platform and rear ladder.

35
STYLE & ACCESSORIES

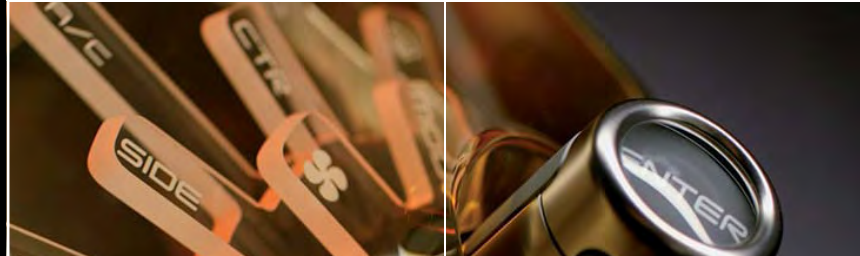
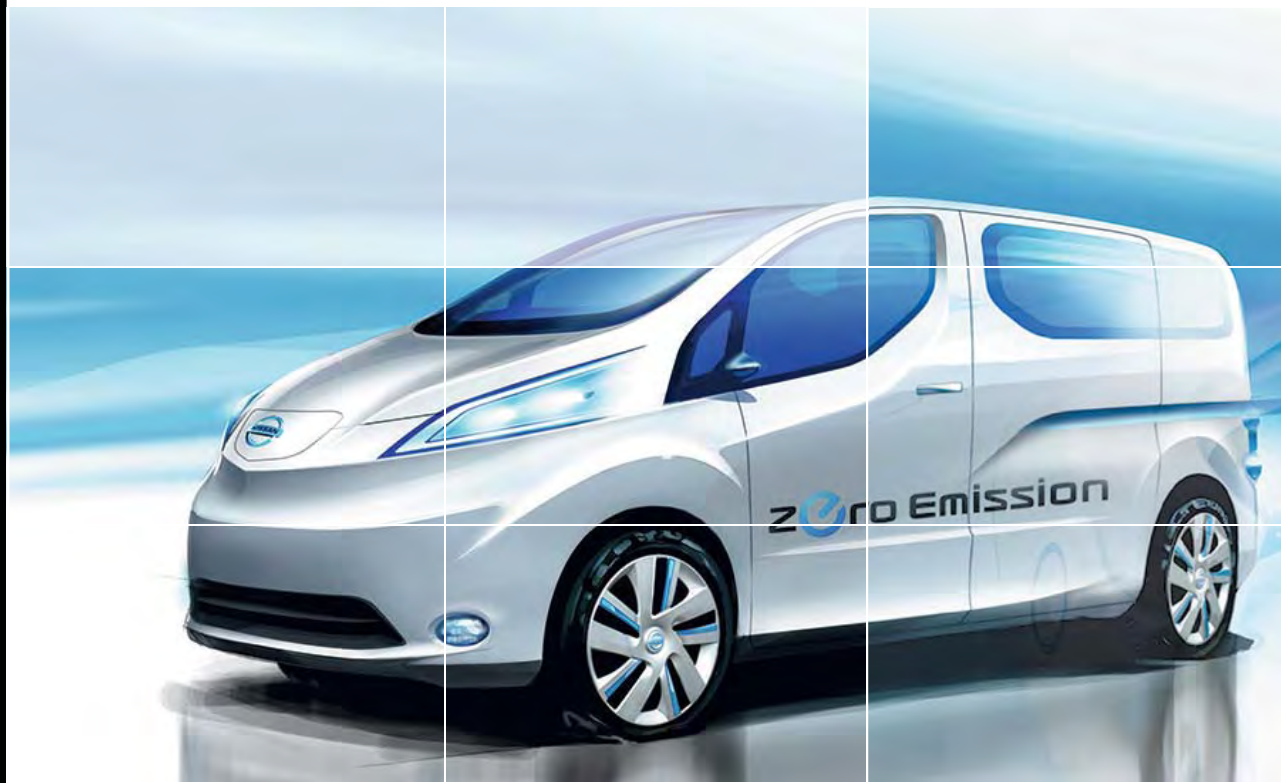

AT NISSAN, YOU BRING OUT THE BEST IN US.

You spark our imagination. You provoke our ingenuity. You inspire us to change the rules and innovate. And at Nissan, innovation is not just about additions and extensions; it's about crossing the line to reinvent the status quo. It's about developing unexpected solutions to satisfy your wildest and most pragmatic desires. At Nissan, we design cars, accessories and services that break the mould - making the practical exciting and the exciting practical to offer you a more exhilarating driving experience everyday.



NISSAN PRIMASTAR OFFERS YOU:

3-YEAR OR 100,000 MILE WARRANTY, WHICHEVER COMES FIRST

12-YEAR ANTI-CORROSION WARRANTY

25,000 MILES EVERY 2 YEAR SERVICE INTERVAL





Visit our website at:
www.nissan.co.uk
www.nissan-lcv.co.uk

Every effort has been made to ensure that the content of this publication is correct at the time of going to press June 2012. This brochure has been produced featuring prototype vehicles exhibited at motor shows. In accordance with the company's policy of continuously improving its products, Nissan Europe reserves the right to change at any time the specification and the vehicles described and shown in this publication. Nissan dealers will be informed of any such modifications as quickly as possible. Please check with your local Nissan dealer to receive the most up-to-date information. Because of the limitations of the printing processes used, the colours shown in this brochure may differ slightly from the actual colours of the paint and interior trim materials used. All rights reserved. Reproduction in whole or part of this brochure without the written permission of Nissan Europe is forbidden.

This brochure is made from chlorinefree paper - X83 GEB - 06/2012 - Printed in E.U. - PART NUMBER 99999-53146
Created by NEW Robinson Creapress, France - Tel: +33 1 40 62 37 37 and produced by E-GRAFICSFRANCE, France - Tel: +33 1 49 09 25 35.



SHIFT the way you move

Dealer stamp:

[REQUEST A TEST DRIVE](#)



NISSAN PRIMASTAR EURO 5
TECHNICAL SPECIFICATIONS



[REQUEST A TEST DRIVE](#)





PRIMASTAR GRADES

Primastar's car-like smoothness, precise steering and good visibility give excellent driver control under all conditions. Now with three grades to choose from Primastar offers the ideal van to suit your needs, whether you need a basic workhorse or comfortable cab loaded with car like features.

E GRADE

CARGO AREA ACCESSIBILITY

- Unglazed 180° opening rear doors
- Unglazed nearside (left) sliding door
- Side and rear door-activated loading lamps
- 6 x Floor mounted lashing rings

SAFETY AND SECURITY

- ABS
- Driver airbag
- 3-Point seatbelts (x2)
- Seatbelt pre-tensioners
- High mounted rear brake lamp
- 4 Disc brakes (ventilated front)
- Side-impact door bars
- 1/3 Tubular bulkhead behind driver
- Engine immobiliser and alarm
- Remote central locking
- Deadlocking
- 2-Button key

COMFORT AND CONVENIENCE

- Single CD player with steering wheel controls
- Aux input socket for MP3 players
- 3-Way adjustable driver's seat with height adjust
- Adjustable single passenger seat
- Tinted windows
- Power assisted steering
- Manual mirrors
- Manual windows
- Tachometer
- Intermittent wash-wipe (windscreen)
- Map lamp
- Dash-mounted gear lever
- Driver and passenger cup holders
- Door pocket with large bottle holder
- Glovebox with CD and sunglasses holder
- Bulkhead coats hooks in cabin

OPTIONS

- Metallic paint

SE GRADE ADDITIONAL TO E GRADE

SAFETY AND SECURITY

- Twin passenger seat with additional 3-point seatbelt

COMFORT AND CONVENIENCE

- 3-Button key with opening/locking of selective doors
- Full steel bulkhead
- Power windows
- Power and heated door mirrors
- Nissan Rear Park System (RPS)
- Trip computer
- Bluetooth

OPTIONS

- Metallic paint
- Power take-off
- Digital tachograph
- Off-side (right) unglazed sliding loading door

OPTION PACKS

- Comfort Pack
- Safety Pack
- Glazed Tailgate Pack
- Glazed Rear Doors Pack

SE+ GRADE ADDITIONAL TO SE GRADE

SAFETY AND SECURITY

- ESP
- Fog lamps
- Passenger airbag

COMFORT AND CONVENIENCE

- Air conditioning with pollen filter
- Automatic wipers and lights
- Full wheel trims
- Wooden floor liner
- Leather steering wheel
- Cruise control

OPTIONS

- Metallic paint

primastar

		MODEL											
Length		Short Wheelbase					Long Wheelbase						
Roof height		Low		High			Low		High				
Engine		M9R 115											
Payload		1000		1200		1200		1200					
Transmission		manual	semi-auto	manual	semi-auto	manual	semi-auto	manual	semi-auto	manual	semi-auto		
ENGINE													
No. of cylinders		4											
Valves per cylinder		4											
Engine capacity		1995 cm ³											
Bore x Stroke		84x90 mm											
Maximum engine power		115 hp											
		3500 rpm											
Maximum torque		300 Nm											
		1500 rpm											
Compression ratio		15.19:1											
Fuel type		Diesel											
Fuel supply		Direct Common Rail											
DRIVE TRAIN													
Transmission		6 Speed manual/6 Speed semi-automatic											
Drive wheels		Front											
CHASSIS													
Suspension		Front Independent, McPherson strut, coil springs, anti-roll bar											
		Rear Torsion beam axle, coil springs with progressive action, shock absorbers with variable damping and anti-roll bar											
Steering		Rack and pinion, power assisted											
Braking system		Ventilated discs front : 305mm/28mm, plain discs rear : 280mm/12mm, Hydraulic braking and two independent circuits in "X", power assisted (EBD, 4 sensor ABS)											
Wheel size		6 J 16											
Tyre size		Standard	205/65	215/65									
PERFORMANCE													
Maximum speed		160 km/h											
		99.4 mph											
Min. turning circle (kerb to kerb)		11.84 m					13.17 m						
FUEL CONSUMPTION & EMISSIONS													
Fuel Consumption		Urban Cycle	l/100 Km / MPG	9.1/ 31.04	7.6/ 37.17	9.1/ 31.04	7.6/ 37.17	9.2/ 30.70	8.1/ 34.87	9.1/ 31.04	7.6/ 37.17	9.2/ 30.70	8.1/ 34.87
		Extra Urban	l/100 Km / MPG	6.5/ 43.46	6.3/ 44.84	6.5/ 43.46	6.3/ 44.84	7.1/ 39.79	7.4/ 38.17	6.5/ 43.46	6.3/ 44.84	7.1/ 39.79	7.4/ 38.17
		Combined	l/100 Km / MPG	7.5/ 37.66	6.8/ 41.54	7.5/ 37.66	6.8/ 41.54	7.9/ 35.76	7.7/ 36.69	7.5/ 37.66	6.8/ 41.54	7.9/ 35.76	7.7/ 36.69
CO ₂ mas Emission (Combined)		grr/Km	198	178	198	178	207	202	198	178	207	202	

		MODEL											
Length		Short Wheelbase					Long Wheelbase						
Roof height		Low		High			Low		High				
Engine		M9R 115											
Payload		1000		1200		1200		1200					
Transmission		manual	semi-auto	manual	semi-auto	manual	semi-auto	manual	semi-auto	manual	semi-auto		
WEIGHTS													
Kerb weight		Min.	kg	1710	1710	1710	1710	1781	1781	1748	1748	1833	1833
Gross vehicle weight		kg		2790	2790	2950	2950	2940	2940	3030	3030	3030	3030
Maximum payload*		kg		1080	1080	1240	1240	1159	1159	1282	1282	1197	1197
Max trailer weight (1)		Braked		2000 kg									
		Unbraked		750 kg									
OVERALL DIMENSIONS													
Length		mm	4782					5182					
Width		mm	1904										
Height (unladen)		Min.	mm	1955	1955	1963	1963	2465	2465	1962	1962	2464	2464
Wheelbase		mm	3098					3498					
Overhang		Front		833 mm									
		Rear		851 mm									
Track		Front		1615 mm									
		Rear		1630 mm									
Ground clearance (unladen)		mm	168	177	178		177		178		177		
CARGO AREA DIMENSIONS													
Maximum length		mm	2400					2800					
Maximum width		mm	1690										
Maximum height		mm	1387			1913			1387		1913		
Maximum width between wheel arches		mm	1268										
Maximum load platform height		mm	534			527			533		525		
Cargo volume		m ³	5.02			7.09			5.94		8.36		
Side door		Width		1000 mm									
		Height		1285 mm									
Back door		Width		1390 mm									
		Height		1335			1818			1335		1818	
FUEL TANK													
Capacity		l	90										

*GVW minus unladen weight (driver and crew weight must be subtracted).

(1) When a vehicle is fitted with a towbar, it is recommended that a tachograph is fitted, since the ability to tow a trailer giving a Gross Train Weight (GVW + Trailer Weight) of over 3,500Kg without a tachograph could be considered to be contrary to EU and UK road traffic legislation.

PRIMASTAR					
Dimensions (mm)		Van			
		SWB Low	SWB High	LWB Low	LWB High
Wheelbase	A	3098		3498	
Overall length	B	4782		5182	
Overall height	C	1955* 1963**	2465	1962	2464
Sill height	D	534	527	533	525
Overall width	E	1904			
Cargo length	F	2400		2800	
Cargo height	G	1387	1913	1387	1913
Cargo width	H	1690			
Width between wheel arches	I	1268			

*1.0 tonne payload models
 **1.2 tonne payload models

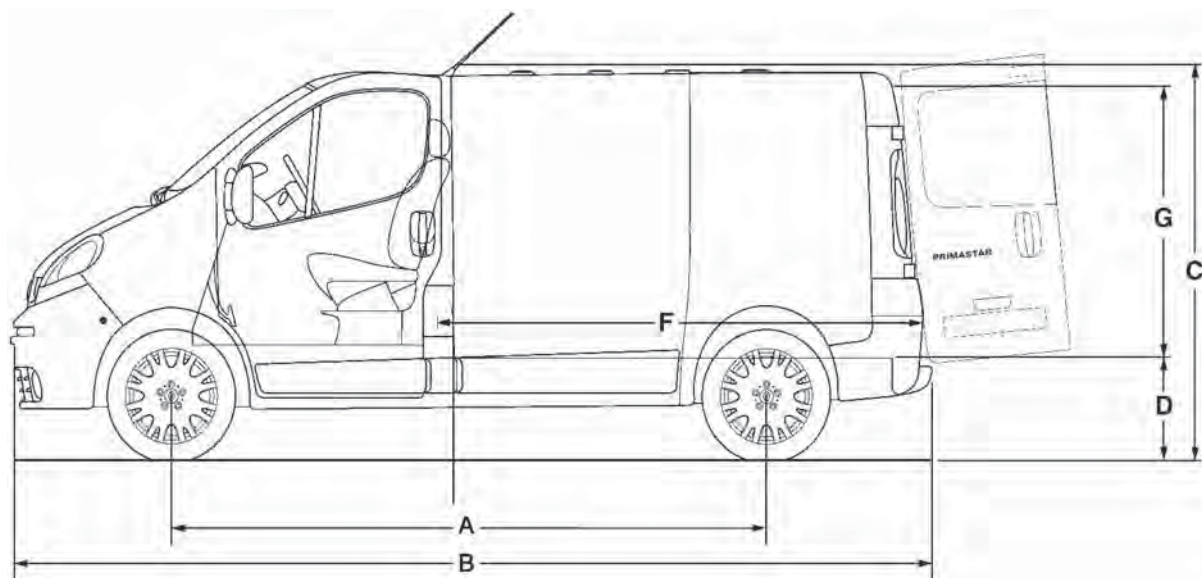
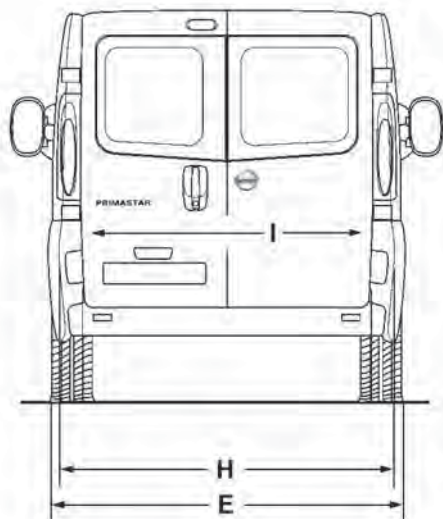



MINIBUS GRADES

The Primastar Minibus is the stylish way to transport up to eight passengers. With the responsiveness of a car and a highly effective braking system of all round disc brakes with ABS and EBD, driver or passenger, everybody can enjoy the ride of the Primastar Minibus. With the availability of several optional extras, it's easy to make the most of the Primastar Minibus, whatever your business; whatever your needs.

SE GRADE

CARGO AREA ACCESSIBILITY

- Rear glazed tailgate
- No bulkhead
- Side and rear door-activated loading lamps
- Rear load area rubber floor covering
- Double sliding doors with opening windows
- Rear wiper
- Heated rear window

SAFETY AND SECURITY

- Driver airbag
- Passenger airbag
- Seatbelt pre-tensioners
- High mounted rear brake lamp
- ABS with EBD and EBA
- Panoramic door mirrors
- Side impact door bars
- 4 Disc brakes (ventilated front)
- Nissan Rear Park System (RPS)
- Immobiliser and alarm
- Remote central locking
- Deadlocking
- 3-Button key

COMFORT AND CONVENIENCE

- Single CD player with steering wheel controls
- Aux input socket for MP3 players
- 3-Way adjustable driver seat and height adjust
- Twin passenger seat-bench with additional 3-point seatbelt
- Removable 2nd row of seats (bench - 3 seats)
- Foldable and removable 3rd row of seats (bench - 3 seats)
- Power assisted steering
- Reach adjustable steering wheel
- One-touch power windows
- Power and heated door mirrors
- Front body coloured bumper - partly coloured
- 3rd Row area with windows
- Trip computer
- Bluetooth

OPTIONS

- Metallic paint
- Digital tachograph and towbar

OPTION PACKS

- Comfort Pack
- Safety Pack
- Combi Cargo

PRIMASTAR MINIBUS			
Dimensions (mm)		Minibus	
		SWB Low	LWB Low
Wheelbase	A	3098	3498
Overall length	B	4782	5182
Overall height	C	1952 - 1956	
Sill height	D	6 seat: 540 / 9 seat: 535	6 seat: 538 / 9 seat 532
Overall width	E	1904	
Cargo length	F	2360/1548	2760/1948
Cargo height	G	1369	
Cargo width	H	1678	
Width between wheel arches	I	1234	

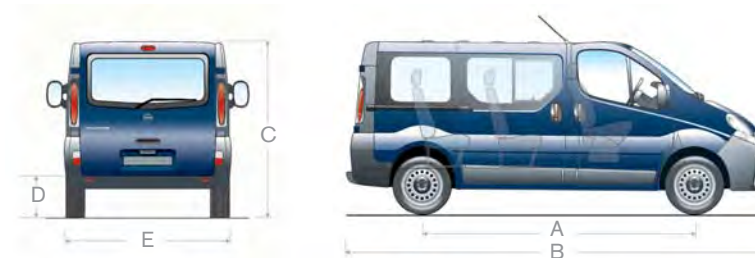

minibus

		MODEL	
		Short Wheelbase	Long Wheelbase
Length			
Roof height		Low	
Engine		M9R 115	M9R 115
Gross vehicle weight		2900	
Seats		9 / 6 Seats	
Transmission		manual	manual
ENGINE			
No. of cylinders		4	
Valves per cylinder		4	
Engine capacity	cm ³	1995	1995
Bore x Stroke	mm	84x90	84x90
Maximum engine power	hp	115	115
	rpm	3500	
Maximum torque	Nm	300	300
	rpm	1500	1500
Compression ratio		15.19:1	15.19:1
Fuel type		Diesel	
Fuel supply		Direct Common Rail	
DRIVE TRAIN			
Transmission		6 speed manual	6 speed manual
Drive wheels		Front	
CHASSIS			
Suspension	Front	Independent, McPherson strut, coil springs, anti-roll bar	
	Rear	Torsion beam axle, coil springs with progressive action, shock absorbers with variable damping and anti-roll bar	
Steering		Rack and pinion, power assisted	
Braking system		Ventilated discs front : 305mm/28mm, plain discs rear : 280mm/12mm, Hydraulic braking and two independent circuits in "X", power assisted (EBD, 4 sensor ABS)	
Wheel size		6 J 16	
Tyre size		215/65	215/65
PERFORMANCE			
Maximum speed	km/h	160	160
	mph	99.4	99.4
Min. turning circle (kerb to kerb)	m	11.84	13.17
FUEL CONSUMPTION & EMISSIONS			
Fuel Consumption	Urban Cycle	l/100 Km / MPG	9.2/30.70
	Extra-Urban	l/100 Km / MPG	6.7/42.16
	Combined	l/100 Km / MPG	7.6/37.17
CO ₂ mas Emission (Combined)	gr/Km	200	200

		MODEL	
		Short Wheelbase	Long Wheelbase
Length			
Roof height		Low	
Engine		M9R 115	M9R 115
Gross vehicle weight		2900	
Seats		9 / 6 Seats	
Engine capacity		manual	manual
WEIGHTS*			
Kerb weight	Min.	kg	1901
Gross vehicle weight			2940
Maximum payload*			1039
Max trailer weight (1)	Braked	kg	2000
	Unbraked	kg	750
OVERALL DIMENSIONS			
Length	mm	4782	5182
Width (Excluding side mirrors)	mm	1904	
Height (unladen)	Min.	mm	1954 / 1956
Wheelbase	mm	3098	3498
Overhang	Front	mm	833
	Rear	mm	851
Track	Front	mm	1615
	Rear	mm	1630
Ground clearance (unladen)	mm	180	179 / 178
CARGO AREA DIMENSIONS			
Maximum length	mm	2360 / 1548	2760 / 1948
Maximum width	mm	1678	
Maximum height	mm	1369	
Maximum width between wheel arches	mm	1234	
Maximum load platform height	mm	534 / 539	532 / 538
Cargo volume	m ³	0.94 / 2.19	1.55 / 2.81
Side door	Width	mm	1000
	Height	mm	1285
Back door	Width	mm	1390
	Height	mm	1306
FUEL TANK			
Capacity	l	90	

*Weights and dimensions for 3 seats/6 seats/9 seats versions without options, driver and passengers, including coolant, oils, spare wheel, tools and 90% full fuel.

*GVW minus unladen weight (driver and crew weight must be subtracted).

(1) When a vehicle is fitted with a towbar, it is recommended that a tachograph is fitted, since the ability to tow a trailer giving a Gross Train Weight (GVW + Trailer Weight) of over 3,500kg without a tachograph could be considered to be contrary to EU and UK road traffic legislation.



SHIFT_ is an English word from a Japanese car company that best embraces our values and the mission of this corporation. No matter where you are in the world, SHIFT_ is the way to express who we are, how we work and what we are trying to accomplish.

Everything we touch, we SHIFT_ and everything we SHIFT_ we try to make better and uniquely Nissan.

Visit our websites at:
www.nissan.co.uk
www.nissan-lcv.co.uk

Dealer stamp:



SHIFT_ the way you move

We take all our environmental responsibilities very seriously – innovation today comes with a deep respect for the environment. Our engines are now much more unobtrusive and their emissions have been considerably reduced. All our vehicles are designed with recycling in mind and are on target to reach 95% recyclability. This brochure is for general guidance only and its contents do not in any way constitute an offer or representation from Nissan. Every effort has been made to ensure the content of this publication is correct at the time of going to press (November 2011). In accordance with the company's policy of continuously improving its products, Nissan reserves the right to change at any time the specification and the vehicles described and shown in this publication. Nissan dealers will be informed of any such modifications as quickly as possible. Please check with your local Authorised Nissan Dealer to receive the most up-to-date information. Because of the limitations of the printing processes used, the colours shown in this brochure may differ slightly from the actual colours of the paint and interior trim materials used. All rights reserved. Reproduction in whole or part of this brochure without the written permission of Nissan is forbidden.

Benefits and services are provided by RAC Motoring Services and/or RAC Insurance Limited. RAC Motoring Services (Company No. 01424399, Head Office: 8 Surrey Street, Norwich, NR1 3NG) in respect of insurance mediation activities only and RAC Insurance Limited (Company No. 2355834, Head Office: 8 Surrey Street, Norwich, NR1 3NG) are authorised and regulated by the Financial Services Authority within the jurisdiction of the Financial Ombudsman Service and the Financial Services Compensation Scheme. Calls may be monitored and/or recorded. Roadside Assistance has been arranged for you by Nissan and is provided by RAC free of charge. Details of the contractual arrangements under which RAC Services are provided to you are available by calling 0870 366 5603.

Part number 99999-53141



[Contents](#) | [Exterior design](#) | [Interior design](#) | [Technology & Performance](#) | [Style & Accessories](#) | [Technical specifications](#) | [Price List](#) | [Commitments](#)

[Print](#) | [Close](#)

[Primastar Model and option prices](#) | [Further Information](#)

[REQUEST A TEST DRIVE](#)



PRIMASTAR VAN

Wheelbase	Engine	Roof	GVW (kg)	Grade	Power (PS)	Payload (kg)	Transmission	Basic Delivered	VED + 1st Reg	Basic On The Road
Short	2.0 dCi	Low	2,700	E	115	1,000	6 manual	16,980	270	17,250
	2.0 dCi	Low	2,700	SE	115	1,000	6 manual	17,480	270	17,750
	2.0 dCi	Low	2,700	SE+	115	1,000	6 manual	18,580	270	18,850
	2.0 dCi	Low	2,700	SE	115	1,000	6 Semi-auto	18,280	270	18,550
	2.0 dCi	Low	2,700	SE+	115	1,000	6 Semi-auto	19,380	270	19,650
	2.0 dCi	Low	2,900	E	115	1,200	6 manual	17,380	270	17,650
	2.0 dCi	Low	2,900	SE	115	1,200	6 manual	17,880	270	18,150
	2.0 dCi	Low	2,900	SE+	115	1,200	6 manual	18,980	270	19,250
	2.0 dCi	Low	2,900	SE	115	1,200	6 Semi-auto	18,680	270	18,950
	2.0 dCi	Low	2,900	SE+	115	1,200	6 Semi-auto	19,780	270	20,050
	2.0 dCi	High	2,900	E	115	1,200	6 manual	18,080	270	18,350
	2.0 dCi	High	2,900	SE	115	1,200	6 manual	18,580	270	18,850
	2.0 dCi	High	2,900	SE+	115	1,200	6 manual	19,680	270	19,950
	2.0 dCi	High	2,900	SE	115	1,200	6 Semi-auto	19,380	270	19,650
	2.0 dCi	High	2,900	SE+	115	1,200	6 Semi-auto	20,480	270	20,750

Wheelbase	Engine	Roof	GVW (kg)	Grade	Power (PS)	Payload (kg)	Transmission	Basic Delivered	VED + 1st Reg	Basic On The Road
Long	2.0 dC	Low	2,900	E	115	1,200	6 manual	18,180	270	18,450
	2.0 dCi	Low	2,900	SE	115	1,200	6 manual	18,680	270	18,950
	2.0 dCi	Low	2,900	SE+	115	1,200	6 manual	19,780	270	20,050
	2.0 dCi	Low	2,900	SE	115	1,200	6 Semi-auto	19,480	270	19,750
	2.0 dCi	Low	2,900	SE+	115	1,200	6 Semi-auto	20,580	270	20,850
	2.0 dCi	High	2,900	E	115	1,200	6 manual	18,880	270	19,150
	2.0 dCi	High	2,900	SE	115	1,200	6 manual	19,380	270	19,650
	2.0 dCi	High	2,900	SE+	115	1,200	6 manual	20,480	270	20,750
	2.0 dCi	High	2,900	SE	115	1,200	6 Semi-auto	20,180	270	20,450
	2.0 dCi	High	2,900	SE+	115	1,200	6 Semi-auto	21,280	270	21,550

PRIMASTAR CREW VAN*

Wheelbase	Engine	Roof	GVW (kg)	Grade	Power (PS)	Payload (kg)	Transmission	Basic Delivered	VED + 1st Reg	Basic On The Road
Short	2.0 dCi	Low	2,900	SE	115	1,100	6 manual	19,980	270	20,250
Long	2.0 dCi	Low	2,900	SE	115	1,100	6 manual	20,780	270	21,050

The Basic Delivered price excludes VAT but includes delivery to the dealership and number plates. The Basic On The Road price excludes VAT but includes delivery to the dealership, number plates, 12 months Vehicle Excise Duty (£215) and Government First Registration Fee of £55.

* Special build conversions may be subject to extended delivery.

PRIMASTAR OPTIONS

	E	SE	SE+	Crew Van SE	Basic Price
Metallic paint	○	○	○	○	350
Power Take-Off (not compatible with air con or semi auto transmission)		○	○		120
Digital Tachograph		○	○		500
Offside (right) Sliding Door		○	○	●	250
Loading ladder (prices from)	□	□	□	□	115.88
Roof rack (prices from)	□	□	□	□	517.98
Single roof bar	□	□	□	□	98.72
Towbar (fixed) and single electrics	□	□	□	□	306.25
OPTION PACKS					
Comfort Pack		○	●	○	675
- Air Conditioning with Pollen Filter					
- Driver Seat Armrest					
- Front Fog Lamps					
- Intelligent Wipers					
- Automatic Lighting System					
Safety Pack		○	●	○	500
- Front Fog Lamps					
- Passenger Airbag					
- ESP					
Glazed Tailgate Pack		○	○		250
- Rear Glazed Tailgate with Wiper					
- Heated Rear Windows					
- Glazed Bulkhead with Rearview Mirror					
Glazed Rear Doors Pack - with Glazed Bulkhead		○	○		200
- Glazed Rear Doors 180° Opening with Wiper					
- Glazed Bulkhead and Interior Rearview Mirror					
- Heated Rear Windows					

For latest information on options that can be combined together, please contact your local Nissan Dealer.
 Dealer fit option prices include fitting but are only a guide. Please check with your local Nissan dealer for exact prices.

Optional - ○ Standard - ● Optional Dealer Fit - □



PRIMASTAR MINIBUS

Wheelbase	Engine	Roof	GVW (kg)	Grade	Power (PS)	Transmission	Basic Delivered	VAT	Total Retail	On The Road
Short	2.0 dCi	Low	2,900	SE	115	6 manual	20,150	4,030	24,180	24,695
Long	2.0 dCi	Low	2,900	SE	115	6 manual	20,950	4,190	25,140	25,655

Basic and Total Retail prices include delivery to the Dealership and number plates. On The Road price includes VAT and 12 months Government Vehicle Excise Duty (£460) and Government First Registration fee of £55.

PRIMASTAR MINIBUS OPTIONS

	SE	Basic Price	VAT	Total
Metallic paint	<input type="radio"/>	350	70	420
Digital Tachograph and Towbar	<input type="radio"/>	825	165	990
Loading Ladder	<input type="checkbox"/>	115.88	23.18	139.06
Roof Rack	<input type="checkbox"/>	517.98	103.60	621.58
Single roof bar	<input type="checkbox"/>	103.10	20.62	123.72
OPTIONS PACKS				
Comfort Pack	<input type="radio"/>	1,250	250	1500
- Air Conditioning (front & rear) + Pollen Filter				
- Front Armrest				
- Intelligent Wipers				
- Automatic Lighting System				
- Front Fog Lamps				
Safety Pack	<input type="radio"/>	750	150	900
- Rear Airbag				
- Front Side Airbags				
- Front Fog Lamps				
- ESP				
- Intelligent Wipers				
- Automatic Lighting System				

Dealer fit option prices include fitting but are only a guide. Please check with your local Nissan dealer for exact prices

Optional - Optional Dealer Fit -



REFRIGERATED RANGE*

Model	Body	Wheelbase	Engine	Power (PS)	Grade	GVW (kg)	Payload (kg)	Transmission	Basic Delivered	VED + 1st Reg	Basic On The Road
NV200	Freezer	Standard	1.5 dCi	89	E	2,000	650	5 Manual	18,415	270	18,685
	Freezer	Standard	1.5 dCi	89	SE	2,000	650	5 Manual	19,100	270	19,370
	Freezer	Standard	1.5 dCi	110	SE	2,000	631	6 Manual	19,450	270	19,720
Primastar	Chiller	Short	2.0 dCi	115	SE	2,950	1,040	6 Manual	22,600	270	22,870
	Freezer	Short	2.0 dCi	115	SE	2,950	1,040	6 Manual	23,500	270	23,770
Cabstar	Chiller	Short	2.5 dCi	140	Basic+	3,500	1,188	5 Manual	30,200	270	30,470
	Freezer	Short	2.5 dCi	140	Basic+	3,500	1,188	5 Manual	30,550	270	30,820
	Chiller	Medium	2.5 dCi	140	Pro	3,500	1,091	6 Manual	31,650	270	31,920
	Freezer	Medium	2.5 dCi	140	Pro	3,500	1,091	6 Manual	32,000	270	32,270

*Special build vehicles may be subject to extended delivery. The Basic Delivered prices excludes VAT but includes delivery to the dealership and number plates. The Basic On The Road price excludes VAT but includes delivery to the dealership, number plates, 12 months Vehicle Excise Duty (£215) and Government First Registration Fee of £55.

REFRIGERATED RANGE OPTIONS

ONE STANDARD COLOUR: WHITE

Van Specification

One piece high thermal efficient GRP panels throughout body construction
 High impact fibreglass, wood free construction
 75mm upturn on floor for leak free bath
 80mm insulation pods
 Freezer -20°C

Cabstar Specification as above plus:

Twin rear doors closed with external stainless steel brace on both doors
 One set stainless steel load lock control system to side panels at 1000mm
 Alloy kick strip protection on side walls and bulkhead to 150mm
 63mm insulation side panels freezer
 25mm insulation side panels chiller
 K factor to 0.34W/°C

Additional cost items (refer to dealer)

Side door
 Curtains at rear
 Curtains at side door
 Power standby
 Rear step
 Folding step (Cabstar)
 Lock load rails
 Temp recorder
 Dual temp compartments (Restricted to certain vehicles)

NISSAN VAN INSURANCE

Did you know you can insure your van through Nissan Insurance?

With Nissan Van Insurance, you can be sure that you'll get the right cover at a great price. You'll also be dealing with people who really understand the way your business works. We know you want to save money, so our premiums are price-matched against the UK's leading insurers to give you great value.

Benefits include:

- Fully comprehensive cover available for virtually any type of business use
- 24/7 accident recovery helpline
- Discounts for branded vans and fixtures such as ladder holders
- Windscreen cover included as standard
- All repairs carried out in a Nissan dealership/Nissan approved repair centre
- All repairs carried out using Nissan Genuine Parts
- Like-for-like replacement provided if your vehicle is written off in the first 12 months

Call for a quote today on **0800 011 3528** and find out just how much money you could save with Nissan Van Insurance.

All quotes are based on individual circumstances and are subject to insurer's underwriting criteria. Terms and conditions apply, Nissan Insurance is arranged and administered by Equity Insurance Brokers Limited, which is authorised and regulated by the Financial Services Authority. Registered Office: Library House, New Road, Brentwood, Essex CM 14 4GD. Registered in England No. 258414. Nissan Motor (GB) Limited is authorised and regulated by the Financial Services Authority.

FURTHER INFORMATION

Price Protection Plan. Order a new Nissan for delivery no more than 4 weeks in advance and the price you are quoted is the price you pay. This is irrespective of any subsequent price rises between placing your order and delivery of your new vehicle. Nissan Motor (GB) is not liable for price adjustments caused by Government changes in the rate of VAT or by any other applicable legislation or regulation or Vehicle Excise Duty.

Navara - Three year/60,000 miles manufacturer's warranty - Nissan's comprehensive warranty provides cover for your new Nissan from defects in materials or workmanship. Your vehicle is covered in all European Countries where Authorised Nissan Dealers are located. If your vehicle becomes inoperative due to warrantable defects, a towing service, when necessary, to the Authorised Dealer is covered. If a warrantable defect abroad takes more than six hours to repair, the Touring Assistance Programme will pay for a hotel or rental car to a certain maximum. The paint warranty covers painted body parts (excluding the underbody) for three years regardless of mileage driven. For further details please contact your local Authorised Nissan Dealer.

LCV model (including NV200, Primastar, NV400 and Cabstar) - New Vehicle Warranty is issued by Nissan International SA is valid for 3 years from the warranty start date or 60,000 miles, whichever comes first. In addition, for each new LCV model (including NV200, Primastar, NV400 and Cabstar) sold by an authorised UK Nissan dealer, Nissan Motor (GB) Limited (NMGB) will issue an extension to the New Vehicle Warranty. This warranty extension will cover your vehicle from 60,000 miles up to 100,000 miles or 3 years from the warranty start date, whichever comes first. Please note that audio and navigation units will not be covered by the warranty extension.

Special build conversions may be subject to extended delivery.

The conversions in this price list are from Nissan Motor GB-appointed converters and have warranty terms in line with the Nissan Pan European Warranty. The converter is responsible for all aspects of the conversion.

Nissan European Roadside Assistance is provided for the first three years of your van's life. Please see www.nissan-aftersales.co.uk for full details including terms and conditions.

Recyclability - we take our environmental responsibilities very seriously - innovation today comes with a deep respect for the environment. Our engines are now much more unobtrusive and their emissions have been considerably reduced. All our vehicles are designed with recycling in mind.

All prices in this list are quoted in pounds sterling. Value Added Tax (VAT) has been calculated at 20%. Accessory prices are subject to change, please see your nearest dealership for the most up to date prices.

While all reasonable effort has been made to ensure the accuracy of the information provided, due to Nissan's policy of continuous product improvement, all particulars contained are subject to constant revision and Nissan reserves the right to change, alter or modify among other things, specifications, colours and prices of models without notice at any time. Accordingly you should consult your local Nissan Dealer for the exact introduction dates of all models and for the most up-to-date information.



YOU + NISSAN

CARE

You care about the car you drive. So do we. That's why we're making a commitment to providing the best customer service in the market.

Find out more nissan.co.uk/care



Nissan cares for you because you care about your Nissan.
That's why we'll make the following commitment:

YOU care about staying on the road when your Nissan is in for service or repair.

YOU care about quality enough to have your Nissan serviced at a Nissan dealership.

YOU care about getting the best value for money when it comes to service and repair.

YOU care about having your problems resolved quickly.

YOU care about getting the right Nissan model, engine & gear box to test drive.

NISSAN will keep you mobile free of charge.

NISSAN says thanks by giving you continuous Nissan roadside assistance for free.

NISSAN will price match like for like competitor written quotes within 10 miles of your local dealer.

NISSAN will propose how to resolve any problem within 2 working days.

NISSAN will guarantee that's what you'll get when you pre-book your test drive either online or through our customer service centre.

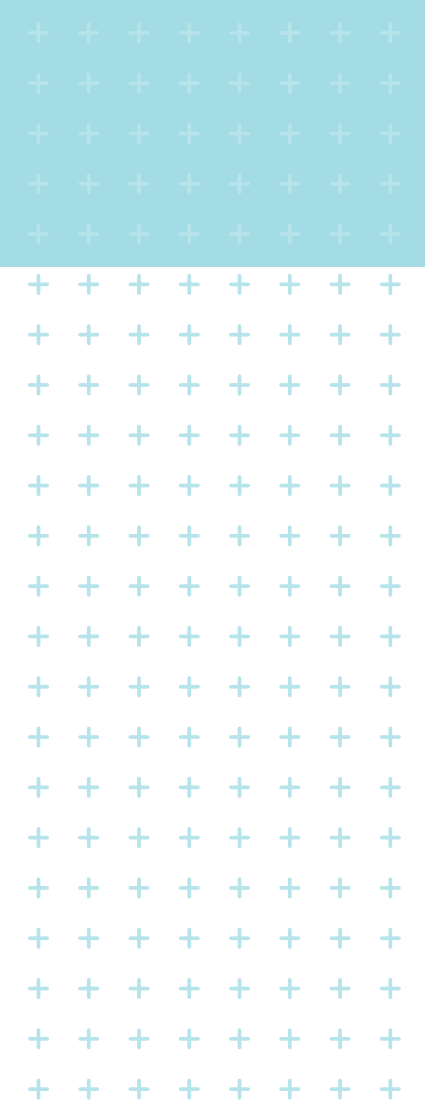

Find out more nissan.co.uk/care



[REQUEST A TEST DRIVE](#)





NV200



NV400



Cabstar

SHIFT_ is an English word from a Japanese car company that best embraces our values and the mission of this corporation. No matter where you are in the world, **SHIFT_** is the way we express who we are, how we work and what we are trying to accomplish.

Everything we touch, we **SHIFT_**. And everything we **SHIFT_** we try to make better and uniquely Nissan.

NISSAN MOTOR (GB) LIMITED

The Rivers Office Park
Denham Way
Maple Cross
Rickmansworth
Hertfordshire
WD3 9YS

Visit our website at: www.nissan.co.uk

Dealer stamp:

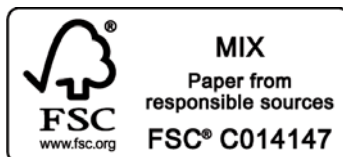

Part Number: 99999-53153

Prices effective from 1st February 2013 unless otherwise stated.