

Audi
Vorsprung durch Technik



The Audi A7 and S7 Sportback

Pricing and Specification Guide

Valid from June 2014

Personalising your Audi A7

This guide has been designed to help you tailor and price your Audi A7 quickly and logically. At the back, you will find information on CO2 emissions-based taxation and the other services offered by Audi, including Finance and Insurance. You can also configure your Audi A7 online at audi.co.uk

Audi Vision

To accompany this printed guide, we've created Audi Vision – an intuitive app that lets you find out even more about the Audi A7. Compatible with Apple and Android phones and tablets, Audi Vision gives you exclusive access to images, information and video content – all of which is designed to help you explore and understand the options available with this model.

You'll see the Audi Vision logo printed next to the page number on pages throughout this guide and wherever you do, you'll be able to view additional content on that page.



The Audi A7 Sportback

Engines	12
Transmissions	13
Efficiency	14
quattro®	16

Model details and prices

A7 model equipment	20
A7 SE model equipment	22
A7 S line model equipment	24
A7 Black Edition model equipment	26
S7 model equipment	28
Model prices	31

Colour and upholstery

Paint	32
Upholstery and seats	36
Colour and trim guide	46

Audi exclusive

48

Inlays

54

Options

Wheels, tyres and suspension	60
Packages	62
Audio and communication	64
Interior equipment	68
Exterior equipment	70
Safety and security	71
Steering wheels	75

Looking after your Audi

Audi Complete and Warranty	76
Accessories	79
Merchandise	80
Audi Difference	81

Technical details

Technical data	82
Dimensions	84
Pricing and Additional information	86





Vorsprung durch Technik

Three words that express the very essence of Audi. Vorsprung durch Technik isn't a slogan. It's our way of seeing the world. It is the driving force behind our history of innovation that continues into the 21st century. Indeed, many technologies that Audi pioneered remain in our cars today. Some are milestones in the history of the motorcar.

From our beginnings in 1899, to the Auto Union team's Grand Prix successes in the 1930s and our more recent wins at Le Mans, we have always been at the forefront of the motor industry.

Vorsprung durch Technik makes us who we are. To see more of its influence, just read on.





The Audi A7 Sportback

The Audi A7 Sportback combines sleek lines with a practical four-door design – its innovative shape and lightweight construction make this model as refined and elegant as it is versatile. It incorporates technologies like the optional cockpit-style 'head-up display' and MMI touchpad control for the Satellite Navigation system. A number of engine options are available – TDI® and TFSI® – which combine remarkable performance with fuel-efficient direct-injection technology.

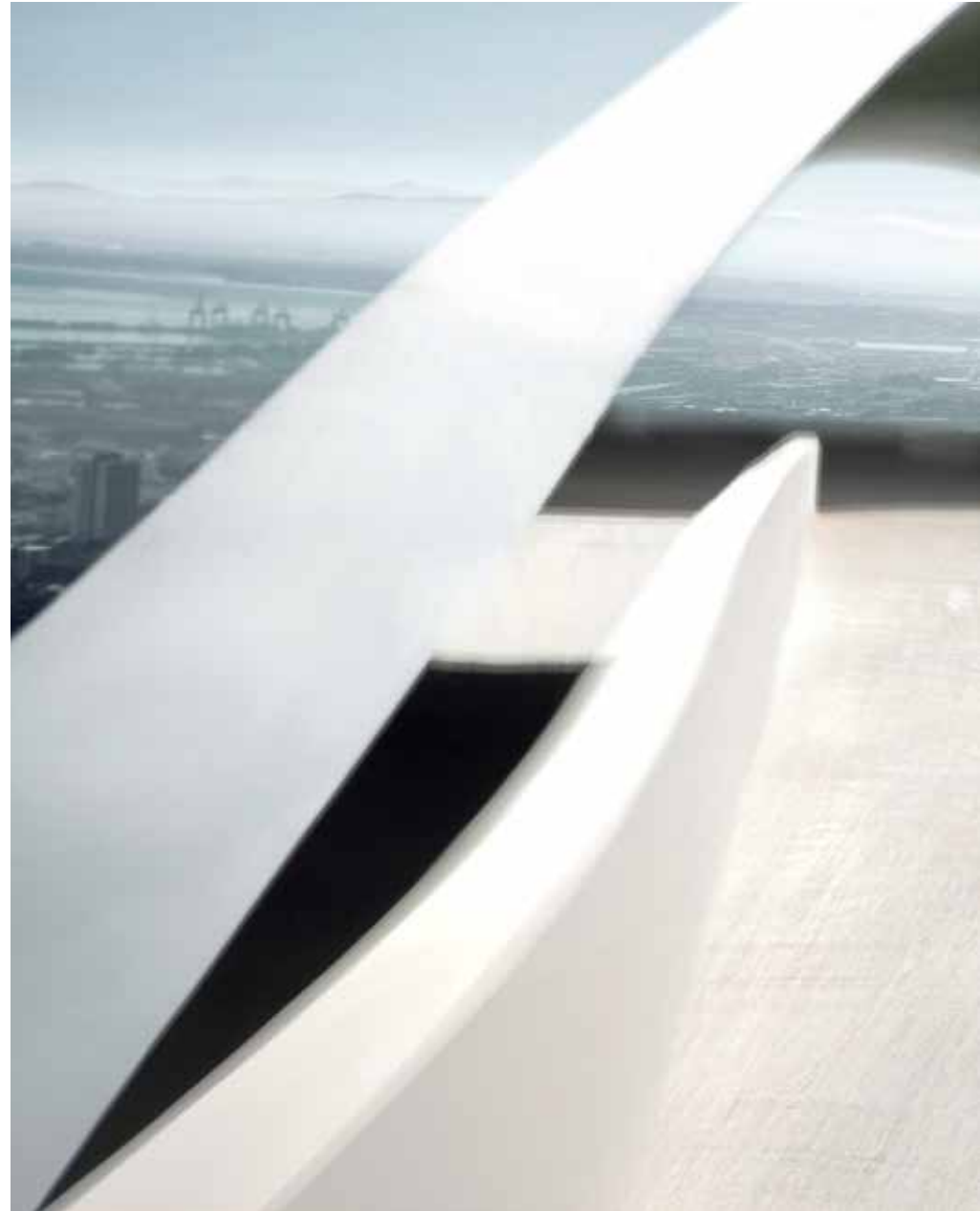







A7 Sportback interior story

We've introduced a number of finishing touches to the Audi A7 Sportback interior to make your driving experience both comfortable and unique. You'll find an impressive attention to detail in everything from the luxurious leather seating to our optional customised stitching, which means that every journey you make will be a personal one.

Engines

Petrol

FSI® direct-injection technology is a unique Audi innovation that was originally developed for the Le Mans 24-hour endurance race to deliver more power and torque, as well as enhanced fuel efficiency. Precisely the right amount of fuel and air are injected into the combustion chambers, enabling the engine to 'breathe' more easily. It results in reduced heat loss and increased output, with around a 15% reduction in fuel consumption and significantly lower exhaust emissions. We've also developed TFSI®, with turbocharging, which combines FSI® technology with forced induction – giving cars an extra injection of power.

Diesel

We introduced TDI® to the roads in 1989, and since then, we've continuously refined it, including developing common-rail technology. Under this system, a series of piezo injectors use electrical charge to precisely control the amount of fuel injected into the engine. As well as reducing noise, this allows combustion to happen at a lower temperature, with less oxygen, which lowers emissions. The recently introduced bi-turbo diesel engine is our most powerful six-cylinder diesel engine to date, capable of 313PS and an impressive combined mpg of 44.8.





Transmissions

multitronic®

Translating a driver's preferences and intentions into road performance, the multitronic® transmission system entertains no compromises – whether in terms of dynamism, convenience or economy. multitronic® automatic transmission is available on models without quattro® permanent all-wheel-drive. A continuously variable transmission, multitronic® can transmit up to 400 Nm of torque and permits an exceptionally wide range of gear ratios. The result is smooth, powerful acceleration and a high level of driving comfort. And thanks to its lightweight design and a number of advanced electronic control systems that monitor gradient, road conditions and the way the driver is using the accelerator pedal, multitronic® also plays an instrumental role in reducing fuel consumption.

S tronic®

Driving is all about thinking ahead, which is just what the S tronic® dual-clutch transmission does. It works almost as two separate systems, one engaging the odd-numbered and the other the even-numbered gears. So when you're accelerating in second, it has third gear waiting for you. And once you make the switch, it's already thinking about fourth. With two clutches working together, you can change gears almost instantly while experiencing smooth, uninterrupted power.

tiptronic®

The 8-speed tiptronic® transmission system reduces both fuel consumption and CO₂ emissions. It converts high-torque engine power into sporty performance and operating convenience, with crisp, fast gear changes and an optimised gear-shift strategy. More spontaneous gear changes are a particular benefit, especially when downshifting. Both in the 'D' (Drive) and 'S' (Sport) programme, the advanced electronics used in tiptronic® respond efficiently to every driver input.

Efficiency

At Audi, doing less is something we're trying to do more of. We're working to use less fuel, release less CO₂ and waste less energy. It's why we've incorporated a number of more efficient technologies into the Audi A7 Sportback.

Recuperation

When a vehicle brakes, the discs convert kinetic energy into thermal energy, which is wasted as it cannot be used. With a recuperation system like the one in the Audi A7 Sportback, the kinetic energy is converted into useful electrical energy. The way it works is simple. While the car is coasting or braking, the alternator voltage is raised above the level of the basic electrical system, which enables the alternator to generate electrical energy and store it temporarily in the battery. When the vehicle accelerates, this energy is used to relieve the load on the alternator, resulting in a fuel saving of up to 3%.





Audi cylinder-on-demand

High performance does not necessarily equate to higher consumption – as the engine of the new S7 proves. Using advanced cylinder-on-demand technology to automatically shut down four of the eight cylinders when they are not required, particularly in city traffic, you benefit from the efficiency and low emissions of a car with a much smaller engine. Out on the open road, meanwhile, the unbridled and instantaneous power of the turbocharged V8 is ready and waiting.

Efficiency programme

The Driver's Information System in the Audi A7 Sportback comes with a special efficiency programme as standard. This offers up-to-the-minute advice on ways to help improve fuel economy as you drive. It also shows you which items in your car are using energy, and how much, so you can make an informed choice about which ones to switch off.

Automatic Start-Stop function

In heavy traffic, your car still uses fuel and releases CO₂, even when it's stationary. The automatic Start-Stop function counteracts this problem by switching off the engine when your car comes to a standstill. As soon as you release the brake pedal, the car restarts.

quattro®

It's the technology that has given Audi the edge on the rally circuit ever since it was first introduced over 30 years ago – a technology that delivers ultimate control whilst enhancing the sporty characteristics which make the A7 Sportback so thrilling to drive. It's called quattro® permanent all-wheel-drive. The principle is simple: in the same way that four brakes ensure better deceleration, four permanently-driven wheels deliver better acceleration and road-holding, pushing or pulling the car as needed, for a driving experience that's both dynamic and safe.

In the A7 Sportback, asymmetric dynamic torque distribution continuously distributes drive power between the front and rear axles, depending on weather conditions, road surface and gradient. This leads to greater flexibility and an enhanced, sportier drive.

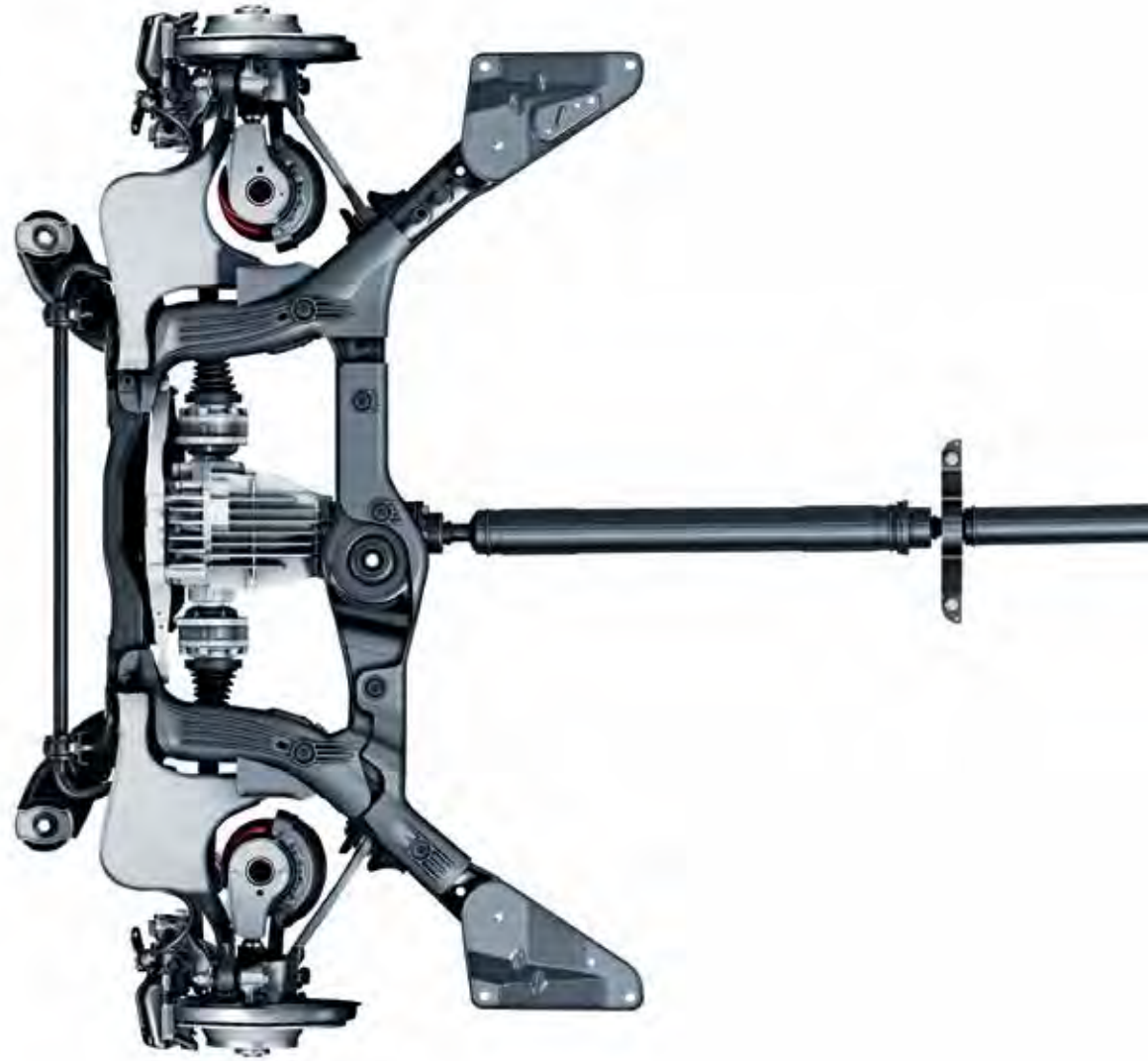

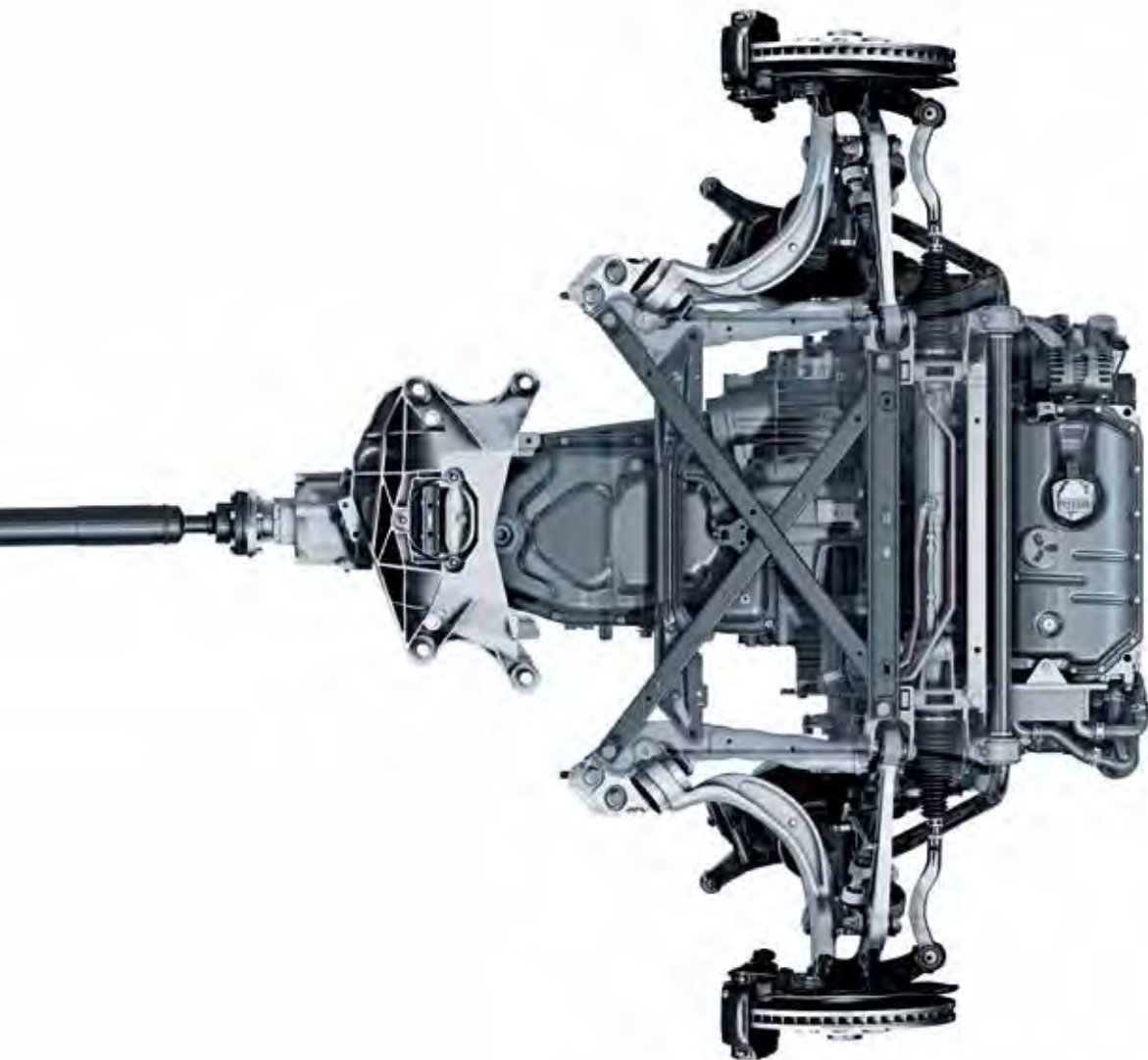

quattro® with Sports differential

The optional electronically regulated Sports differential distributes variable amounts of drive force to each rear wheel, ensuring outstanding acceleration performance in corners and stabilising the vehicle's response to load change. It also brings better direct steering characteristics and, as it requires less steering effort, more agile handling.





A7 model equipment

All A7 Sportback models have the following items of standard equipment

Engines

Start-Stop system with energy recovery

Wheels, tyres and suspension

18" x 8.5J '7-arm Dynamic' design alloy wheels, with 255/45 R18 tyres

Audi drive select with four pre-configured modes (Comfort, Auto, Dynamic and Efficiency), allowing the driver to electronically adjust the engine, transmission and steering. The new efficiency mode influences the shift programme, electromechanical power steering, engine, cruise control, and where fitted, deluxe automatic air conditioning, adaptive air suspension and quattro with Sports differential

Locking wheel bolts

Space-saver spare wheel

Audio and communication

Audi sound system

- 6-channel amplifier
- 180-watt amplifying capacity
- 10 loudspeakers including subwoofer located in spare wheel well

MMI Radio Plus including:

- MMI control panel for operating the MMI display (6.5" colour display on the dashboard)
- 2 x SDHC memory card readers (up to 32GB)
- Single CD player and memory card reader that supports MP3, WMA and AAC
- TP memo – automatically saves traffic news when driving

DAB digital radio reception – receives programmes from digital radio transmitters in addition to the range of analogue stations, with better sound quality. With the DAB twin tuner, a second DAB tuner permanently searches for alternative reception frequencies of the set station, and updates the station list

MMI Navigation (SD card based) including:

- 6.5" MMI colour display with high quality map display
- Voice control using whole words
- Dynamic route guidance

Mobile telephone preparation – Low.

A hands-free facility (including voice control for the telephone functions) and a fitting for an optional mobile-specific charger located in the centre armrest. Simply operated via the MMI, the multi-function steering wheel or the voice control system. Please contact your local Audi Centre for phone compatibility

Driver's Information System (DIS) –

5" TFT monochrome display which displays information such as audio, navigation and trip computer. There is also an efficiency program that offers fuel saving tips and a rest recommendation feature which visually and acoustically alerts the driver to take a break when getting tired

AUX-IN socket

Safety and security

Auto-dimming rear-view mirror

Anti-theft alarm with tow-away protection via angle of inclination sensors (can be switched off), including interior monitoring system which can be switched off; alarm for monitoring doors, bonnet and tailgate, independent of vehicle electrical system

Light and rain sensor – automatically switches the dipped beam or windscreen wipers on/off depending on the light and rain conditions; includes delayed deactivation/automatic activation of the rear lights and number plate lights when parking or opening the vehicle



Electronic Stability Control (ESC)

Front airbags with front passenger deactivation – also includes front side airbags and curtain airbags

Tool kit, warning triangle and car jack

Tyre Pressure loss indicator – visual and acoustic warning if the pressure drops in one or more tyres

Keyless go – conveniently allows the engine to be started by simply pressing the start/stop button in the centre console. The key just needs to be carried

Hill-hold assist holds the vehicle stationary for unlimited periods after stopping on uphill and downhill gradients

Seats

Split-folding rear seat with 3 head restraints and 3 rear seat belts (available with only 2 head restraints and 2 rear seat belts at no extra cost)

ISOFIX child seat mounting – for front passenger (with airbag deactivation) and outer rear seats. Including Top Tether attachment point for the outer rear seats

Standard seats in Milano leather upholstery including seat covers, head restraints and front centre armrest. The leather is hard-wearing and durable. Includes manual adjustment for seat height, length, backrest angle, head restraint, belt height and steering wheel reach and height

Interior equipment

4-spoke leather-trimmed multi-function steering wheel – with gear-shift paddles

Electronically controlled automatic air conditioning – separate temperature distribution for driver and front passenger

Door sill trims with aluminium inlay

Inlays in matt brushed aluminium

Floor mats, front and rear – coordinated with the selected interior colour

Front centre armrest for driver and front passenger, movable and with adjustable angle

Non-smoking package comprises a 12V socket in the front and rear centre consoles

Exterior equipment

Exterior mirrors, heated and electrically adjustable

Headlight washer system

High-gloss package – includes window trim surround in aluminium and B-pillar trim in high-gloss black finish

Power-operated boot lid – electrically opening and closing

LED tail-lights

Xenon all-weather headlights with LED daytime-running lights

Retractable rear spoiler



Image shows the A7 Sportback model with optional Ice silver, metallic paint (P5)

A7 SE model equipment

In addition to A7 model equipment

Basic RRP
£3,137.50

Total RRP inc VAT
£3,765.00

Audio and communication

Audi Music Interface – universal connection for use with stereo audio sources, USB and MP3 devices including Apple iPod generation 4 onwards (iPod, iPod classic, iPod mini, iPod nano, iPod photo, iPod video, iPod touch). Provides intuitive control through the audio system and multi-function steering wheel. It also replicates the iPod display on the audio screen and Driver's Information System (DIS), including track titles. The interface provides charging function (dependent on device)

Colour Driver's Information System (DIS) with 7" high resolution TFT screen. Shows information from the driver assistance systems; media in use, rest recommendation, telephone menu, outside temperature and other MMI content

Safety and security

Cruise control – maintains any speed above 18mph, provided that the engine power output and engine braking effect permit it; operated via separate steering column stalk, set speed displayed in Driver's Information System (DIS)

Seats

Electrically adjustable front seats – including adjustment for:
- Forwards/backwards position
- Seat height and angle
- Backrest angle
- Memory function for driver's side

Electrically adjustable 4-way lumbar support

Heated driver and front-passenger seats – heats the seat cushions, backrest surfaces and seat side bolsters and can be individually adjusted in 3 stages for each seat via a direct selection button on the air conditioning controls

Interior equipment

Light package – includes lighting for:
- Exterior: courtesy lighting on the underside of the door handles and door handle lighting with LED technology; automatically activated when the doors are unlocked; includes active internal door reflectors
- Interior: LED technology – 2 reading lights at front and rear, front footwell, inside door handles, make-up lights, storage compartment in the centre console, ambient lighting of the centre console, ambient reflected light for inside door trims

Exterior equipment

Audi Parking System Plus – acoustic and visual park assist system for the front and rear with MMI screen display

Exterior mirrors – heated and electrically adjustable with automatic kerb view function which tilts the passenger mirror downwards towards the kerb when reverse gear is engaged. Includes memory function





Image shows the A7 Sportback SE model with optional Ice silver, metallic paint (P5)

A7 S line model equipment

In addition to A7 SE model equipment

Basic RRP

£1,491.67

Total RRP inc VAT

£1,790.00

Wheels, tyres and suspension

19" x 9J '5-twin-spoke' design alloy wheels with 255/40 R19 tyres

Sports suspension lowered by 10mm with more firmly tuned springs and dampers for more direct contact with the road

Seats

Electrically adjustable front Sports seats including memory function for the driver's side

Upholstery in black Valcona leather with S line logo embossed in the front seat backrests

Interior equipment

Black headlining

Door sill trims with S line logo

Gear lever knob in black perforated leather

S line 3-spoke leather multi-function

Sports steering wheel with paddles and S line badge

Exterior equipment

Platinum grey front spoiler lip and diffuser insert

S line badges on the front wings

S line front and rear bumpers, side ventilation grilles, side skirts and diffuser insert



19" x 9J '5-twin-spoke' design alloy wheels



S line 3-spoke leather multi-function Sports steering wheel



S line body styling



Image shows the A7 Sportback S line model with optional Dakota grey, metallic paint (Y7)

A7 Black Edition model equipment

In addition to A7 S line model equipment

Basic RRP
£1,958.33

Total RRP inc VAT
£2,350.00

Wheels, tyres and suspension

21" x 9J '5-arm Rotor' design titanium-look alloy wheels with 275/30 R21 tyres

S line Sports suspension with more dynamic suspension tuning and vehicle lowered by 10mm (over Sports suspension)

Audio and communication

BOSE® Surround Sound

Interior equipment

Inlays in Piano finish, black

Exterior equipment

Black styling package – includes radiator grille frame and radiator grille struts in high-gloss black, radar sensor surrounds (if fitted) in the side ventilation grille in high-gloss black, radiator grille in matt black, front side grilles in matt black, number plate holder in matt black, window capping strips and side profile roof trim strip in high-gloss black.

Privacy glass. Dark-tinted rear and rear-side windows (from B-pillar backwards)





Image shows the A7 Sportback Black Edition model with optional Daytona grey, pearl effect paint (6Y) and Adaptive cruise control with Stop&Go function (PCG)

S7 model equipment

In addition to A7 SE model equipment

Engine and transmission

Audi cylinder-on-demand technology

Active noise cancellation system – effectively compensates for noise interference inside the car, depending on the interior noise level and engine speed. Four microphones installed in the roof lining register background engine noise and, if necessary, a precisely calculated antiphase sound is emitted through the car's internal sound system

75 litre fuel tank

Wheels, tyres and suspension

19" x 8.5J '5-parallel spoke' S design alloy wheels with 255/40 R19 tyres

'S' Sports adaptive air suspension – electronically controlled air suspension with continuously adaptive damping system on all 4 wheels to automatically regulate vehicle ride height by up to 20mm depending upon mode. Choice of 4 modes – Auto, Comfort, Dynamic and Lift, selected via the MMI system

quattro with Sports differential – the electronically regulated Sports differential distributes variable amounts of driving force to each rear wheel ensuring outstanding acceleration performance when cornering. It also ensures better steering characteristics and more agile handling

Seats

Valcona leather upholstery

'S' Super Sports front seats with driver's side memory function (12-way adjustable) including:

- Stitched diamond design with embossed S7 badge
- Electrically adjustable seat height
- Electrically adjustable seat forwards and backwards position
- Electrically adjustable upper backrest angle
- Electrically adjustable seat cushion angle
- 4-way electric lumbar support

Heated front seats

'S' Super Sports rear seats – in a 2 seat configuration with shaped bolsters and integrated head restraints, with central storage tray and split-folding



19" x 8.5J '5-parallel spoke' S design alloy wheels



Inlays and gear selector lever in Carbon atlas

Interior equipment

'S' 3-spoke leather multi-function Sports steering wheel with gear-shift paddles, contrast stitching and S7 emblem

Aluminium door sill trims with S7 logo

Inlays in Carbon atlas including upper dashboard, instrument panel, centre console and door trims

'S' instrument dials

Storage package consisting of 2 drink holders in the rear centre armrest, luggage net and 2 12V sockets in the rear

Deluxe 4-zone automatic air conditioning – includes front control panel with digital display, as well as separate temperature control for the driver and front passenger sides. There are additional controls with digital display in the rear, with separately adjustable temperature and blower settings for right and left side

Lighting package – includes lighting for the interior and exterior

Start/stop button with red surround

Exterior equipment

Aluminium-effect door mirror housings

Exterior mirrors – heated, electrically adjustable and with memory function

Dual-branch oval twin tailpipes in chrome finish

Platinum grey 'S' single-frame radiator grille – with dual struts in chrome and S7 logo

Matt black painted brake calipers with S7 logo

'S' body coloured side sill trims

Front bumper air intakes with aluminium-effect accents

Platinum grey rear bumper diffuser insert with aluminium-effect strip

Safety and security

'S' model enhanced braking system

Tracking system preparation



'S' instrument dials



Platinum grey 'S' single-frame radiator grille and S7 logo



A7

Engines	Power	Transmissions	CO ₂ g/km	Basic RRP	Total RRP inc VAT	Recommended OTR
3.0 TDI	204PS	8-speed multitronic	135	£33,666.67	£40,400.00	£41,175.00

A7 SE

Engines	Power	Transmissions	CO ₂ g/km	Basic RRP	Total RRP inc VAT	Recommended OTR
3.0 TFSI quattro	310PS	7-speed S tronic	190	£39,991.67	£47,990.00	£49,120.00
3.0 TDI	204PS	8-speed multitronic	135	£36,658.33	£43,990.00	£44,765.00
3.0 TDI quattro	204PS	7-speed S tronic	152	£38,016.67	£45,620.00	£46,445.00
3.0 TDI quattro	245PS	7-speed S tronic	156	£40,158.33	£48,190.00	£49,015.00
3.0 BiTDI quattro	313PS	8-speed tiptronic	166	£43,104.17	£51,725.00	£52,660.00

Please note: The maximum power output figures are quoted in PS (or Pferdestärke, which is the metric equivalent of brake horsepower). To convert to brake horsepower, divide the PS figure by 1.0139.

Recommended On-The-Road (OTR) retail prices include: delivery charge, half a tank of fuel, number plates at £590.00 (inc. VAT), Road Fund Licence (which may vary depending on model/transmission – see page B7 for details) and first registration fee at £55.00. Vehicle Excise Duty correct at time of going to print, but this may alter to reflect any change in the applicable VED rate.

RRP – Recommended Retail Price.

VAT is calculated at 20% but this may alter to reflect any change in the applicable VAT rate.

A7 S line

Engines	Power	Transmissions	CO ₂ g/km	Basic RRP	Total RRP inc VAT	Recommended OTR
3.0 TFSI quattro	310PS	7-speed S tronic	190	£41,483.33	£49,780.00	£50,910.00
3.0 TDI	204PS	8-speed multitronic	135	£38,150.00	£45,780.00	£46,555.00
3.0 TDI quattro	204PS	7-speed S tronic	152	£39,508.33	£47,410.00	£48,235.00
3.0 TDI quattro	245PS	7-speed S tronic	156	£41,650.00	£49,980.00	£50,805.00
3.0 BiTDI quattro	313PS	8-speed tiptronic	166	£44,595.83	£53,515.00	£54,450.00

A7 Black Edition

Engines	Power	Transmissions	CO ₂ g/km	Basic RRP	Total RRP inc VAT	Recommended OTR
3.0 TFSI quattro	310PS	7-speed S tronic	190	£43,411.67	£52,130.00	£53,260.00
3.0 TDI quattro	204PS	7-speed S tronic	152	£41,466.67	£49,760.00	£50,585.00
3.0 TDI quattro	245PS	7-speed S tronic	156	£43,608.33	£52,330.00	£53,155.00
3.0 BiTDI quattro	313PS	8-speed tiptronic	166	£46,544.17	£55,865.00	£56,800.00

S7 Sportback

Engine	Power	Transmission	CO ₂ g/km	Basic RRP	Total RRP inc VAT	Recommended OTR
4.0 TFSI quattro	420PS	7-speed S tronic	225	£50,887.50	£61,065.00	£62,345.00

Paint

We believe that every part of your car should have a personal touch. Which is why you can choose from a wide range of paint colours and finishes, from standard shades to metallic and pearl effects. We can even mix a customised colour for you to create the perfect fit.

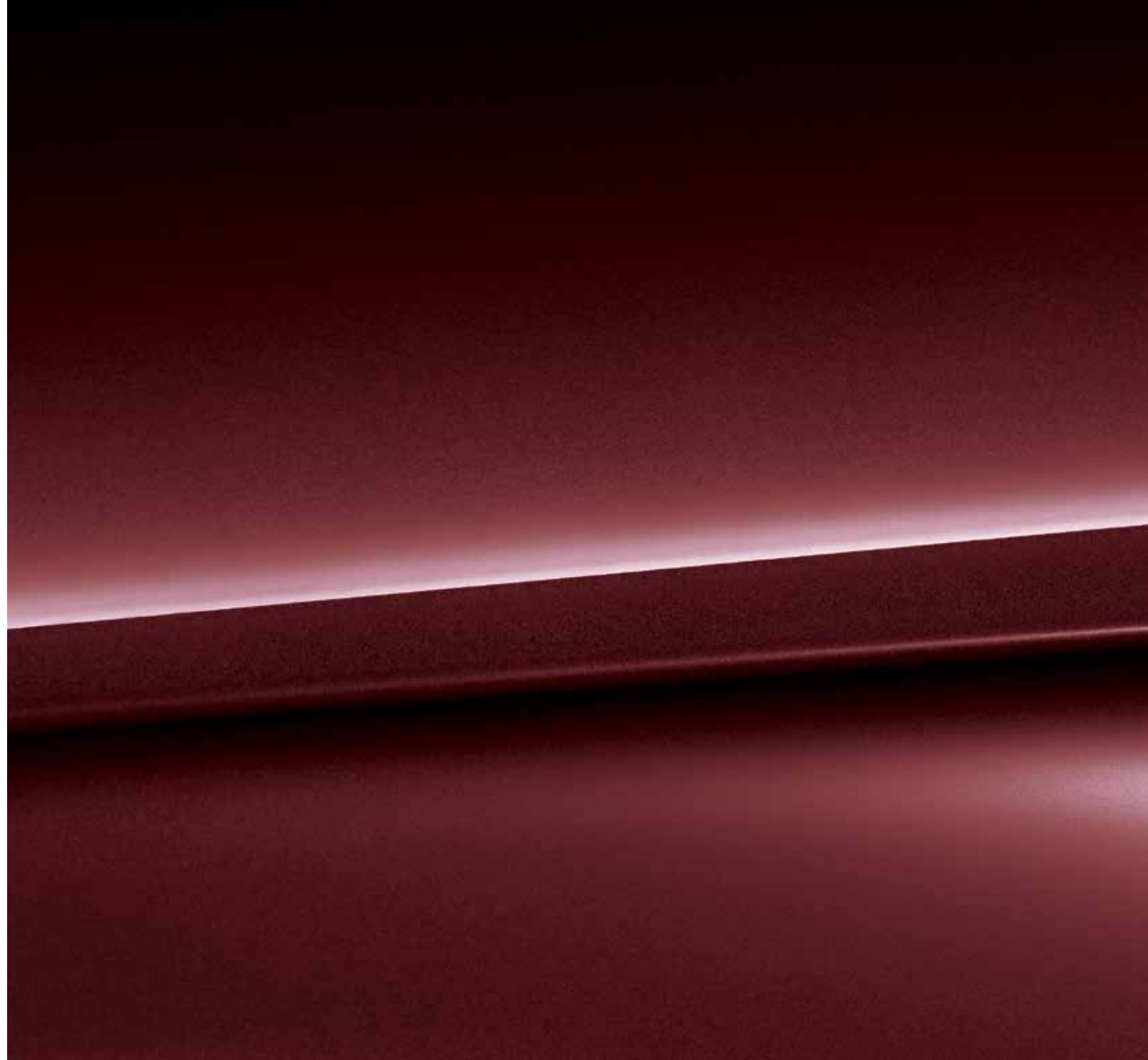

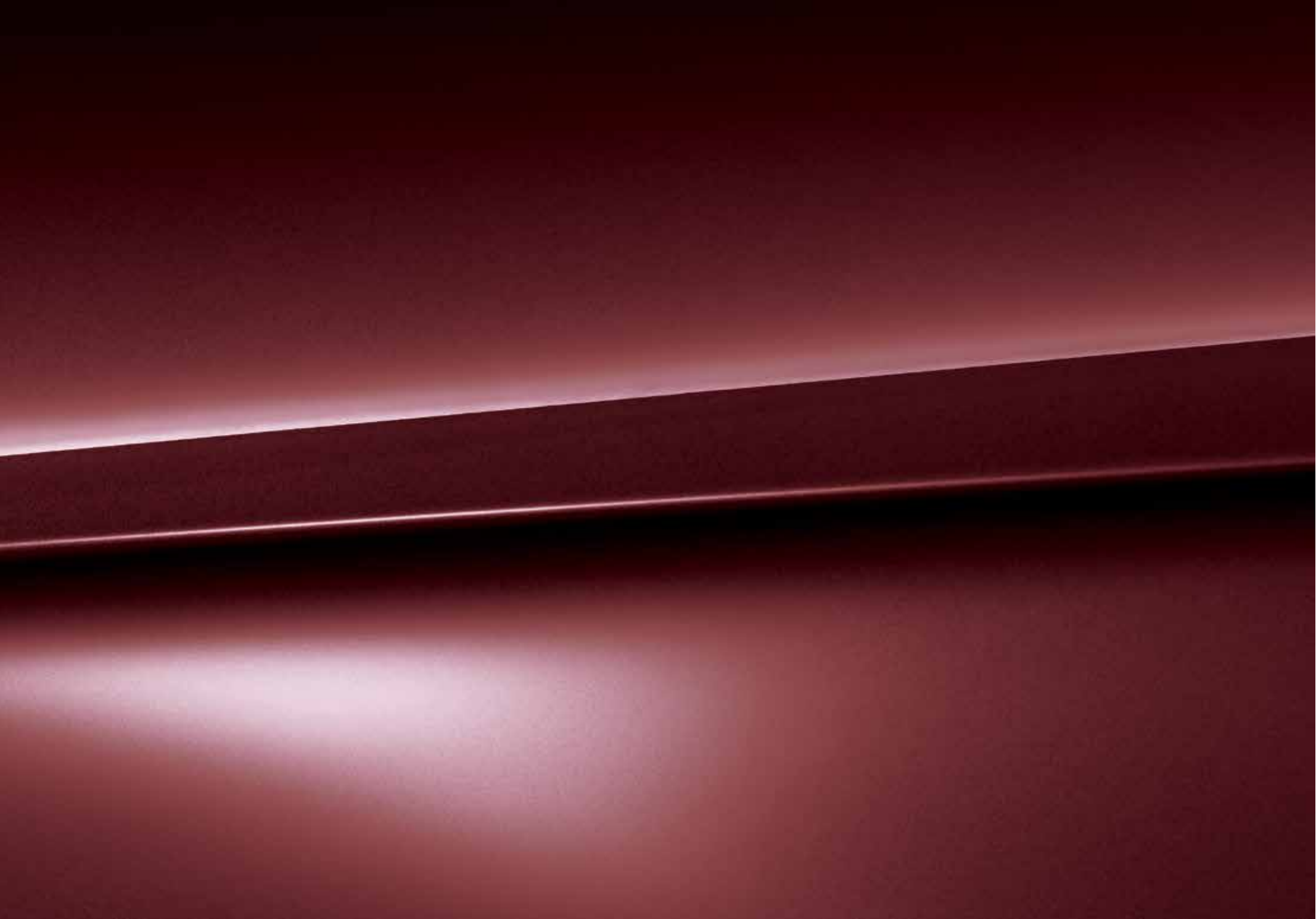

Paint

You can select one of the standard colours shown opposite or, for a different look, choose from a range of optional finishes.

Standard colours



Ibis white - T9

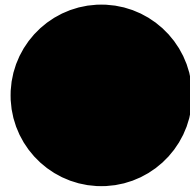

Brilliant black - A2

Optional colours

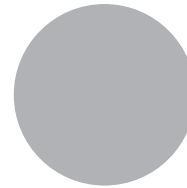

Ice silver, metallic - P5

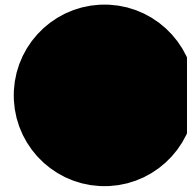

Havanna black, metallic - 4J



Glacier white, metallic - 2Y

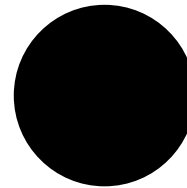

Phantom black, pearl effect - L8

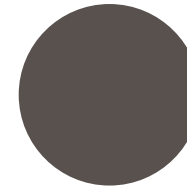

Dakota grey, metallic - Y7*

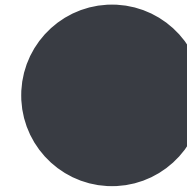

Oolong grey, metallic - 4N

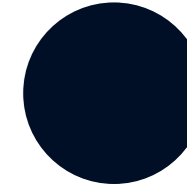

Moonlight blue, metallic - W1

S line colour

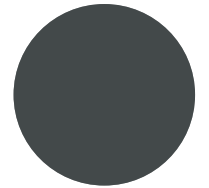

Daytona grey, pearl effect - 6Y*

*Not available on S7

Options are subject to availability and may extend delivery.

All the colour swatches on this page are matched as accurately as possible to the actual paint colours used. However, due to print processes, Audi UK cannot guarantee that colours shown are 100% accurate.

Visit your local Audi Centre for a more accurate colour swatch.

RRP - Recommended Retail Price.

VAT is calculated at 20% but this may alter to reflect any change in the applicable VAT rate.

Optional and S line colours

Basic RRP
£545.83

Total RRP inc VAT
£655.00

Paint

Audi exclusive

Everyone has a favourite colour. No matter what yours is, Audi exclusive provides a range of unique colours that have been designed to set your car apart. Choose from the swatches here, or specify any other paint colour in the Audi range.*

Customised

If you have a particular colour in mind, we'll mix the exact metallic or pearl-effect shade you want.**

*Audi exclusive paint is subject to factory approval. Visit your local Audi Centre for colour samples.

**Customised paint is subject to factory approval, and is available for metallic and pearl-effect water-based paints only. Three-colour process colours and two-tone schemes are not available.

All the colour swatches on this page are matched as accurately as possible to the actual paint colours used. However, due to print processes, Audi UK cannot guarantee that colours shown are 100% accurate.

Visit your local Audi Centre for a more accurate colour swatch.

RRP - Recommended Retail Price.

VAT is calculated at 20% but this may alter to reflect any change in the applicable VAT rate.

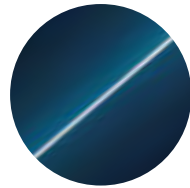

Palace blue, pearl effect

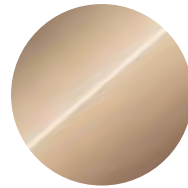

Sand beige, pearl effect

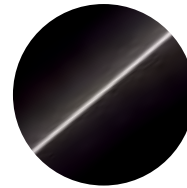

Saddle brown, pearl effect

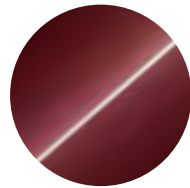

Classic red, pearl effect

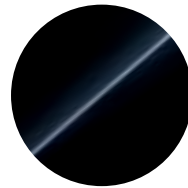

Mamba black, metallic

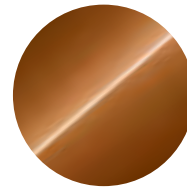

Ipanema brown, metallic



Any colour in the Audi range or 100 exclusive colours to choose from*



Customised paint**

Audi exclusive*

Basic RRP
£1,795.83

Total RRP inc VAT
£2,155.00

Customised**

Basic RRP
£2,212.50

Total RRP inc VAT
£2,655.00

Upholstery

It's important to feel comfortable on the road. Just choose from our range of luxury upholstery materials and textures, including additional support and colour options, for complete relaxation while you drive.





Upholstery

Standard seats

Choose your favourite upholstery from the swatches shown opposite to give your car's interior the look and feel you want.

Milano leather
– NSW



Black – FZ



Titanium grey – VC/KN



Velvet beige – VD/KP

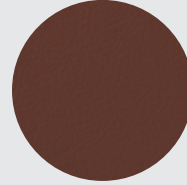

Nougat brown – VB

Valcona leather
– NSD



Black – FZ



Titanium grey – VC/KN



Velvet beige – VD/KP

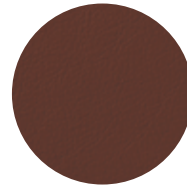

Nougat brown – VB

	A7	A7 SE	A7 S line	A7 Black Edition	S7	Basic RRP	Total RRP inc VAT
Milano leather – NSW	S	S	–	–	–	No charge	No charge
Valcona leather – NSD	•	•	–	–	–	£416.67	£500.00

Options are subject to availability and may extend delivery.

- = Not available
- = Available
- S = Standard

All leather upholstery choices include seats, head restraints, door inserts and front centre armrest in leather.

RRP – Recommended Retail Price.

VAT is calculated at 20% but this may alter to reflect any change in the applicable VAT rate.



Standard seat with optional 4-way lumbar support

Upholstery

Standard seats

Order Code		A7	A7 SE	A7 S line	A7 Black Edition	S7	Basic RRP	Total RRP inc VAT
3NZ	4 seat option. Includes only 2 rear seat belts and headrests for the rear	●	●	–	–	–	No charge	No charge
PV3	Electrically adjustable front seats. With memory function for driver's side. Electrical adjustment for seat forwards and backwards position, seat height, angle and backrest angle adjustment, 4-way lumbar support and driver's side with memory function. On entry trim, must be combined with exterior mirrors with memory function (6XF/6XL/6XM)	●	S	–	–	–	£766.67	£920.00
7P1	4-way electric lumbar support. For driver's and front passenger seats, with horizontal and vertical adjustment	●	S	–	–	–	£245.83	£295.00
4A3	Front heated seats. Heats the seat cushions, backrest surfaces and seat side bolsters and can be individually adjusted in 3 stages for each seat via a direct selection button on the air conditioning controls. On entry trim, must be combined with lumbar support (7P1)	●	S	–	–	–	£250.00	£300.00
4A4	Front and rear heated seats. Works in the same way as front seat heating, enabling you to regulate the rear seats separately. Only in combination with deluxe 4-zone climate control (9AQ). On entry trim, must be combined with lumbar support (7P1)	●	–	–	–	–	£366.67	£440.00
		–	●	–	–	–	£116.67	£140.00
4D3	Seat ventilation for front seats. 3 different intensities of cool air are drawn through the seat (for Comfort seats), or a fan (for Standard seats) provides active ventilation of the seat centre section and thigh support. To allow for the seat ventilation, the leather of the seat front is perforated. When ordered in combination with Standard seats, must be combined with deluxe 4-zone climate control (9AQ) and Milano leather (N5W). On entry trim, must also be combined with electrically adjustable front seats (PV3) and heated seats (4A3/4A4)	●	●	–	–	–	£700.00	£840.00

Options are subject to availability and may extend delivery.

– = Not available
● = Available
S = Standard

All leather upholstery choices include seats, head restraints, door inserts and front centre armrest in leather.

RRP – Recommended Retail Price.

VAT is calculated at 20% but this may alter to reflect any change in the applicable VAT rate.

Upholstery

Comfort seats – PS8

18-way adjustable seats with memory function for both front seats and mirrors. Electric adjustment of seat forwards and backwards position, cushion angle, height, thigh support and backrest angle. Manual adjustment of seat belt height and head rest height and proximity. Pneumatic adjustment of bolsters (on backrest and seat cushion) and lumbar support.

Options are subject to availability and may extend delivery.

- = Not available
 • = Available
 S = Standard

All leather upholstery choices include seats, head restraints, door inserts and front centre armrest in leather.





*Not available on S7.

**Comfort seats on S7 must be ordered with split-folding rear seat without storage tray (3NZ).

*When choosing Valcona leather with Comfort seats you must also have seat ventilation (4D3/4D8), heated seats (4A3/4A4) and deluxe 4-zone climate control (9AQ).

RRP – Recommended Retail Price.

VAT is calculated at 20% but this may alter to reflect any change in the applicable VAT rate.

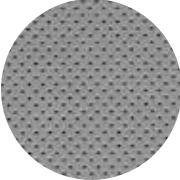
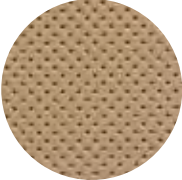
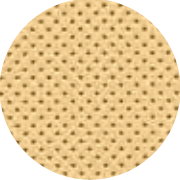
		A7	A7 SE	A7 S line	A7 Black Edition	S7**	Basic RRP	Total RRP inc VAT
Milano leather* – NSW		•	-	-	-	-	£2,166.67	£2,600.00
		-	•	-	-	-	£1,083.33	£1,300.00
		-	-	-	-	-		
		-	-	-	-	-		
Valcona leather* – NSD		•	-	-	-	-	£2,583.33	£3,100.00
		-	•	-	-	-	£1,500.00	£1,800.00
		-	-	-	-	•	No charge	No charge
		-	-	-	-	-		



Comfort seat

Upholstery

Comfort seats – PS8

Order Code		A7	A7 SE	A7 S line	A7 Black Edition	S7	Basic RRP	Total RRP inc VAT
3NZ	4 seat option. Includes only 2 rear seat belts and headrests for the rear	●	●	–	–	S	No charge	No charge
4A3	Front heated seats. For driver and front-passenger seats. Heats the seat cushions, backrest surfaces and seat side bolsters and can be individually adjusted in 3 stages for each seat via a direct selection button on the air conditioning controls	●	S	–	–	S	£250.00	£300.00
4A4	Front and rear heated seats. Works in the same way as front seat heating, enabling you to regulate the rear seats separately. Only in combination with deluxe 4-zone climate control (9AQ)	● –	– ●	– –	– –	– ●	£366.67 £116.67	£440.00 £140.00
4D3	Seat ventilation for front seats. 3 different intensities of cool air are drawn through the seat (for Comfort seats) or a fan (for Standard seats). Provides active ventilation of the seat centre section and thigh support. To allow for the seat ventilation, the leather of the seat front is perforated. Only in combination with deluxe 4-zone climate control (9AQ) and Valcona leather (NSD). On entry trim, must also be combined with heated seats (4A3/4A4)	●	●	–	–	●	£700.00	£840.00
4DB	Massage and seat ventilation for front seats. Massage function with 5 different programmes (wave, pulse, stretch, lumbar, shoulders) and 4 levels of intensity for massaging the muscles using 10 pneumatic cushions. 3 different intensities of cool air are drawn through the seat for active ventilation of the seat centre section and thigh support. To allow for the seat ventilation, the leather of the seat front is perforated. Only in combination with deluxe 4-zone climate control (9AQ) and Valcona leather (NSD). On entry trim, must also be combined with heated seats (4A3/4A4)	●	●	–	–	●	£1,333.33	£1,600.00

Options are subject to availability and may extend delivery.

- = Not available
- = Available
- S = Standard

All leather upholstery choices include seats, head restraints, door inserts and front centre armrest in leather.

RRP – Recommended Retail Price.

VAT is calculated at 20% but this may alter to reflect any change in the applicable VAT rate.

Upholstery

S line Sports seats

Front S line electrically adjustable Sports seats including 4-way electrical lumbar adjustment and memory function for driver's side. Front seats with S line logo. If you select Alcantara/Pearl Nappa leather, this comes with Black/Jet grey stitching on seats, steering wheel, gear lever gaiter and floor mats.

Valcona leather
- N1V

Perforated leather/Alcantara
- N7K



Black - QE



Black - QZ

Options are subject to availability and may extend delivery.

- = Not available
- = Available
- S = Standard

All leather upholstery choices include seats, head restraints, door inserts and front centre armrest in leather. Leather/Alcantara choices include head restraints, seat side bolsters and front centre armrest in leather with the seat centres and door inserts in Alcantara.

RRP - Recommended Retail Price.

VAT is calculated at 20% but this may alter to reflect any change in the applicable VAT rate.

Order Code	A7	A7 SE	A7 S line	A7 Black Edition	S7	Basic RRP	Total RRP inc VAT
	-	-	S	S	-	No charge	No charge
	-	-	•	•	-	No charge	No charge

Order Code	A7	A7 SE	A7 S line	A7 Black Edition	S7	Basic RRP	Total RRP inc VAT
3NZ	-	-	•	•	-	No charge	No charge
4A4	-	-	•	•	-	£116.67	£140.00

4 seat option. Includes only 2 rear seat belts and headrests for the rear

Front and rear heated seats. Works in the same way as front seat heating, enabling you to regulate the rear seats separately. Only in combination with deluxe 4-zone climate control (9AQ)



S line interior in Alcantara/leather

Upholstery

S Super Sports seats – Q4Q

Front S Super Sports seats are electrically adjustable with driver's side memory, and include electric 4-way lumbar support. Key features include extra lateral support, integrated head restraints and extendable thigh support.

Valcona leather
S-embossed
– NOK

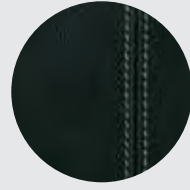

Black – IM

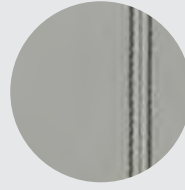

Lunar silver – IL

Leather/Alcantara
S-embossed
– N7N



Black – SX

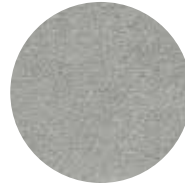

Lunar silver – IN

Options are subject to availability and may extend delivery.

- = Not available
- = Available
- S = Standard

All leather upholstery choices include seats, head restraints, door inserts and front centre armrest in leather. Leather/Alcantara choices include head restraints, seat side bolsters and front centre armrest in leather with the seat centres and door inserts in Alcantara.

RRP – Recommended Retail Price.

VAT is calculated at 20% but this may alter to reflect any change in the applicable VAT rate.

	A7	A7 SE	A7 S line	A7 Black Edition	S7	Basic RRP	Total RRP inc VAT
Valcona leather S-embossed – NOK	–	–	–	–	S	No charge	No charge
Leather/Alcantara S-embossed – N7N	–	–	–	–	•	No charge	No charge

Upholstery

S Super Sports seats options

Order Code		A7	A7 SE	A7 S line	A7 Black Edition	S7	Basic RRP	Total RRP inc VAT
4A3	Front heated seats. For driver and front-passenger seats. Heats the seat cushions, backrest surfaces and seat side bolsters and can be individually adjusted in 3 stages for each seat via a direct selection button on the air conditioning controls	-	-	-	-	S	No charge	No charge
4A4	Front and rear heated seats. Works in the same way as front seat heating, enabling you to regulate the rear seats separately	-	-	-	-	●	£116.67	£140.00
PV3	Electrically adjustable front seats. With memory function for driver's side. Electrical adjustment for seat forwards and backwards position, seat height, angle and backrest angle adjustment, 4-way lumbar support and driver's side with memory function	-	-	-	-	S	No charge	No charge



S Super Sports seat in Black Valcona leather

Colour and trim guide

Interior trim colours

Standard seats

To help you choose the right interior for your new A7 Sportback, please use this guide, showing the carpet, dashboard and headlining colours that have been matched to your chosen upholstery.

Order Code	Upholstery	Carpet	Dashboard (upper/lower)	Headlining	Milano leather (N5W)	Valcona leather (N5D)
FZ	Black	Black	Black	Lunar silver	●	●
VA	Goa beige	Black	Black	Black	—	●
VB	Nougat brown	Black	Black	Lunar silver	●	●
VC	Titanium grey	Steel grey	Steel grey/Titanium grey	Lunar silver	●	●
VD	Velvet beige	Moor brown	Moor brown/Velvet beige	Silk beige	●	●
KN*	Titanium grey	Titanium grey	Steel grey/Titanium grey	Lunar silver	●	●
KP*	Velvet beige	Velvet beige	Moor brown/Velvet beige	Silk beige	●	●

Comfort seats

Order Code	Upholstery	Carpet	Dashboard (upper/lower)	Headlining	Milano leather (N5W)	Valcona leather (N5D)
FZ	Black	Black	Black	Lunar silver	●	●
VA	Goa beige	Black	Black	Black	—	●
VB	Nougat brown	Black	Black	Lunar silver	●	—
VC	Titanium grey	Steel grey	Steel grey/Titanium grey	Lunar silver	●	●
VD	Velvet beige	Moor brown	Moor brown/Velvet beige	Silk beige	●	●
KN*	Titanium grey	Titanium grey	Steel grey/Titanium grey	Lunar silver	●	●
KP*	Velvet beige	Velvet beige	Moor brown/Velvet beige	Silk beige	●	●
SX**	Black	Black	Black/Black	Lunar silver	—	●

Options are subject to availability and may extend delivery.

— = Not available
● = Available

*Including two-section dashboard and door trim panels, single/multi-tone.

**S7 only.

RRP – Recommended Retail Price.

VAT is calculated at 20% but this may alter to reflect any change in the applicable VAT rate.

Colour and trim guide

Interior trim colours

S line Sports seats

Order Code	Upholstery	Carpet	Dashboard (upper/lower)	Headlining	Alcantara/Pearl Nappa leather (N7K)	Valcona leather (N1V)
QZ (Jet grey stitching)***	Black	Black/Black	Black	Black	●	—
QE (Black stitching)***	Black	Black/Black	Black	Black	—	●

S Super Sports seats

Order Code	Upholstery	Carpet	Dashboard (upper/lower)	Headlining	Leather/Alcantara (N7N)	Valcona leather (N0K)
IM*	Black	Black	Black	Lunar silver	—	●
IL**	Lunar silver	Black	Black	Lunar silver	—	●
SX	Black	Black	Black	Lunar silver	●	—
IN	Lunar silver	Black	Black	Lunar silver	●	—

Options are subject to availability and may extend delivery.

- = Not available
- = Available

***Black/Jet grey stitching on seats, steering wheel, gear lever gaiter and floor mats.

*Dark silver stitching on seats, steering wheel, gear-lever gaiter and floor mats.

**Graphite grey stitching on seats, steering wheel, gear-lever gaiter and floor mats.

RRP – Recommended Retail Price.

VAT is calculated at 20% but this may alter to reflect any change in the applicable VAT rate.



Rear S Super Sports seats with centre storage console in IM Black Valcona leather (N0K)

Audi exclusive

Audi exclusive enables you to create an Audi that's unique to you, with precisely the colours, finishes and interior detailing you want. You can customise as much or as little as you like, specify just one detail or design your car's overall appearance. It's entirely up to you.

Leather and stitching colours, inlays and carpets can all be tailored, and with hundreds of possible paint combinations we're sure to find the exterior colour you have in mind. We can even mix the exact metallic paint or pearlescent shade you want for your Audi.





Upholstery

Audi exclusive

With Audi exclusive, you can specify your seats in Valcona leather, Fine Nappa leather or a leather/Alcantara combination, in an array of different colours shown to the right.

Select just one all-over shade for each seat, or customise each panel in two or more complementary colours from the distinctive Audi exclusive palette. You can even choose the colour of the decorative stitching – to match or contrast with your chosen upholstery – from this varied collection. Whatever combination you decide upon, we think you'll be extremely satisfied with the result.

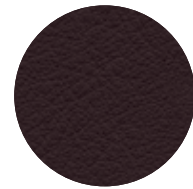

Chestnut brown



Jet grey



Alabaster white

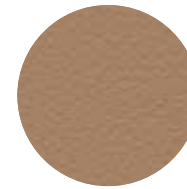

Sand beige

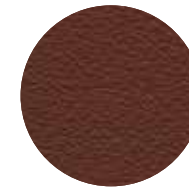

Saddle brown



Crimson red



Magnolia white



Havana brown

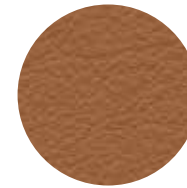

Cognac brown

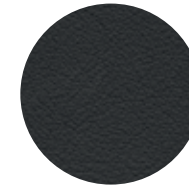

Night blue



Cloudy grey

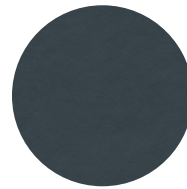

Smoky blue

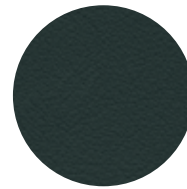

Iceland green



Powder beige

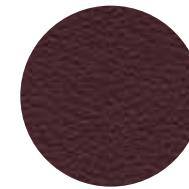

Classic red



Alcantara colours: available in all the Audi exclusive colours shown, except for Crimson red and Sand beige. Alcantara equivalents are Chilli red and Sesame beige respectively.

Please consult your Audi Centre for examples of Alcantara and carpet colours.



Upholstery

Audi exclusive

Order Code		A7	A7 SE	A7 S line	A7 Black Edition	S7	Basic RRP	Total RRP inc VAT
PYB S3G	Audi exclusive leather package 1 in Valcona leather.* Includes leather-covered seat upholstery, door trim inserts, head restraints, lower centre console and front centre armrest. On entry trim, only available in combination with 4-way lumbar support (7P1)	●	●	●	●	●	£4,166.67	£5,000.00
PYC S3G	Audi exclusive leather package 1 in Valcona leather/Alcantara.* Includes leather-covered seat-side trims, head restraints, lower centre console and front centre armrest and Alcantara door trim inserts and seat centre sections. Not available with standard seats or comfort seats (PS8)	–	–	●	●	●	£4,166.67	£5,000.00
PYR S3G	Audi exclusive leather package 2 in Valcona leather.* Includes all the contents of leather package 1 (PYB/S3G) plus: leather-covered seat backrest covers, door armrests and handles. Seat-side trims and add-on parts are colour coordinated. On entry trim, only available in combination with 4-way lumbar support (7P1)	●	●	–	–	–	£7,225.00	£8,670.00

Options are subject to availability and may extend delivery.

- = Not available
- = Available
- S = Standard

*Leather and stitching (where applicable) can be specified in a variety of colours from the Audi exclusive range shown on page 50.

RRP – Recommended Retail Price.

VAT is calculated at 20% but this may alter to reflect any change in the applicable VAT rate.



Audi exclusive leather package 1



Audi exclusive leather package 2

Upholstery

Audi exclusive interior options

Order Code		A7	A7 SE	A7 S line	A7 Black Edition	S7	Basic RRP	Total RRP inc VAT
YTO S3G	Audi exclusive seat belts*	●	●	●	●	●	£1,375.00	£1,650.00
YRH S3G	Audi exclusive leather-covered steering wheel.* Available on 3-spoke or 4-spoke steering wheels. Not available in combination with Audi exclusive controls package (YRB/S3G)	●	●	●	●	●	£458.33	£550.00
YRB S3G	Audi exclusive controls package.* Includes leather-covered steering wheel and selector lever. Not available in combination with Audi exclusive leather-covered steering wheel (YRH/S3G)	●	●	●	●	●	£691.67	£830.00
6F9	Steering wheel in wood segment design. Only in conjunction with leather-covered multi-function steering wheel in 4-spoke design with shift paddles and Walnut dark brown inlays (5MG). Not available in combination with Audi exclusive wood inlays	●	●	–	–	–	£508.33	£610.00
YSR S3G	Audi exclusive floor mats with leather piping.** Also includes 4 floor mats for front and rear. Not available in combination with Audi exclusive carpets (YSQ/S3G)	●	●	●	●	●	£395.83	£475.00
YSQ S3G	Audi exclusive carpets.** Also includes 4 Audi exclusive floor mats with leather piping. Not available in combination with Audi exclusive floor mats (YSR/S3G)	●	●	●	●	●	£1,750.00	£2,100.00

Options are subject to availability and may extend delivery.

– = Not available
● = Available
S = Standard

*Leather and stitching (where applicable) can be specified in a variety of colours from the Audi exclusive range shown on page 50.

**The floor mats and carpet colour can be specified in a variety of colours from the Audi exclusive range shown on page 50.

RRP – Recommended Retail Price.

VAT is calculated at 20% but this may alter to reflect any change in the applicable VAT rate.



Audi exclusive part-wood, part-leather steering wheel



Audi exclusive controls package



Audi exclusive wood gear lever knob



Inlays

Attention to detail can make a big impact. From contemporary black Piano finish to a brown walnut, our selection of inlays make the perfect finishing touch to your car's interior.





Inlays

Inlays are the all-important finishing touch that add flair and interest to your car's interior.

Order Code		A7	A7 SE	A7 S line	A7 Black Edition	S7	Basic RRP	Total RRP inc VAT
5TG	Matt brushed aluminium. Covers centre console, door trims and the continuous inlay seam	S	S	S	-	-	No charge	No charge
5MG	Walnut, brown. Covers centre console, door trims and the continuous inlay seam, with aluminum-look edging	●	●	-	-	-	£320.83	£385.00
5MK	Carbon atlas. Covers centre console, door trims and the continuous inlay seam, with aluminum-look edging	-	-	-	-	S	No charge	No charge
7TL	Fine grain ash, natural brown. Covers centre console, door trims and the continuous inlay seam, with aluminum-look edging	●	●	●	-	-	£320.83	£385.00
		-	-	-	-	●	No charge	No charge
5MT	Oakwood, beaufort. Covers centre console, door trims and the continuous inlay seam, with aluminum-look edging	●	●	-	-	-	£583.33	£700.00
		-	-	-	-	●	£62.50	£75.00
5TL	Piano finish, black. Covers centre console, door trims and the continuous inlay seam, with aluminum-look edging	●	●	●	S	●	£583.33	£700.00
5TB	Aluminium, beaufort black. Covers centre console, door trims and the continuous inlay seam, with aluminum-look edging	-	-	●	●	-	£2,000.00	£2,400.00
		-	-	-	-	●	£1,666.67	£2,000.00

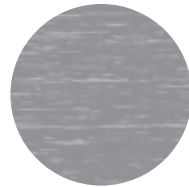

Matt-brushed aluminium – 5TG



Walnut, brown – 5MG

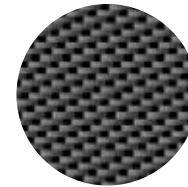

Carbon atlas – 5MK

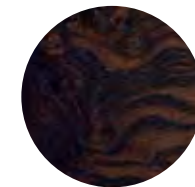

Fine grain ash, natural brown – 7TL

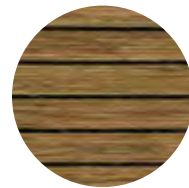

Oakwood, beaufort – 5MT

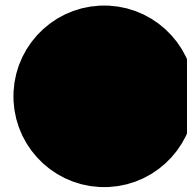

Piano finish, black – 5TL



Aluminium, beaufort black – 5TB

Options are subject to availability and may extend delivery.

- = Not available
● = Available
S = Standard

RRP – Recommended Retail Price.

VAT is calculated at 20% but this may alter to reflect any change in the applicable VAT rate.

Inlays

Audi exclusive

Audi exclusive has sourced a wide range of materials which you can select for your inlays, from Fine grain ash nougat to Oak sepia.

Order Code		A7	A7 SE	A7 S line	A7 Black Edition	S7	Basic RRP	Total RRP inc VAT
YTA S3G	Audi exclusive inlays. Cannot be combined with inlays shown on page 56. Not in combination with wooden Sports steering wheel	•	•	•	•	•	£1,137.50	£1,365.00



Fine grain ash, nougat



Fine grain myrtle, nutmeg



Modrone wood, gold



Vavona wood, bronze



Tamo ash, dark brown

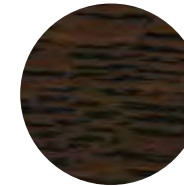

Oak, sepia



Options are subject to availability and may extend delivery.

- = Not available
- = Available
- S = Standard

RRP – Recommended Retail Price.

VAT is calculated at 20% but this may alter to reflect any change in the applicable VAT rate.

Options

Every driver has different needs, which is why we have created some useful options to further enhance your car. For extra comfort, support, style or function, you can choose from a variety of additional features, tailoring everything from your infotainment and audio equipment to your wheels and lighting.





Wheels, tyres and suspension

Choose a set of specially-selected alloy wheels to subtly enhance the way your car looks and drives. You can also specify Audi drive select, which allows you to change suspension and steering settings according to your driving style.



19" x 8.5J '10-spoke' design
alloy wheels - PRT



19" x 8.5J '5-arm Y' design
alloy wheels - PRV



20" x 9J '10-parallel-spoke' design
alloy wheels - PRC



20" x 9J '5-parallel-spoke Star'
S design alloy wheels - PRJ



21" x 9J '5-arm Rotor' design
alloy wheels - PQW

Wheels, tyres and suspension

Order Code		A7	A7 SE	A7 S line	A7 Black Edition	S7	Basic RRP	Total RRP inc VAT
PRT	19" x 8.5J '10-spoke' design alloy wheels with 255/40 R19 tyres	●	●	–	–	–	£825.00	£990.00
PRV	19" x 8.5J '5-arm Y' design alloy wheels with 255/40 R19 tyres	●	●	–	–	–	£825.00	£990.00
PRC	20" x 9J '10-parallel-spoke' design alloy wheels with 265/35 R20 tyres	●	●	–	–	–	£1,658.33	£1,990.00
PRJ	20" x 9J '5-parallel-spoke Star' S design alloy wheels with 265/35 R20 tyres	–	–	–	–	●	£1,250.00	£1,500.00
PQW	21" x 9J '5-arm Rotor' design alloy wheels with 275/35 ZR21 tyres	–	–	–	–	●	£1,958.33	£2,350.00
1BK	Adaptive air suspension. Electronically controlled air suspension with infinitely variable adaptive damping system on all 4 wheels, which automatically regulates vehicle ride height and damping, including ride height control. Different modes (Comfort, Dynamic, Auto and additional 'Lift' function for increased ground clearance) selected via Audi drive select	●	●	●	●	–	£1,666.67	£2,000.00
GH2	quattro with Sports differential. The electronically regulated Sports differential distributes variable amounts of driving force to each rear wheel, ensuring outstanding acceleration performance in corners and stabilising the vehicle's response to load change. It also ensures better direct steering characteristics and, thanks to less steering effort, more agile handling. Not available on 204PS engines	–	●	●	●	S	£916.67	£1,100.00
H46	Run-flat tyres. Journey can be continued on a flat tyre at a speed of up to 50mph and for a maximum distance of 18 miles, without having to change the wheel. Only in combination with 19" x 8.5J '10-spoke' design alloy wheels (PRT) and tyre repair kit (1G8)	●	●	–	–	–	£262.50	£315.00
1BE	Sports suspension lowered by 10mm with more firmly tuned springs and dampers for more direct contact with the road	●	●	S	–	–	£341.67	£410.00
1BV	S line Sports suspension with more dynamic suspension tuning and vehicle lowered by 10mm (over Sports suspension 1BE)	–	–	●	S	–	No charge	No charge
1N8	Dynamic steering. With this technology, driving is significantly more agile under everyday conditions, while directional stability and precision are increased at high speeds and in demanding driving situations	●	●	●	●	●	£1,008.33	£1,210.00
PCS	Ceramic brakes 19" high-performance braking system with carbon fibre-reinforced ceramic brake discs in front and rear. Includes specially designed cooling ducts in the ventilated and perforated brake discs, brake calipers in high gloss anthracite, and 'Audi ceramic' inscription on front calipers	–	–	–	–	●	£7,208.33	£8,650.00

Options are subject to availability and may extend delivery.

– = Not available

● = Available

S = Standard

RRP – Recommended Retail Price.

VAT is calculated at 20% but this may alter to reflect any change in the applicable VAT rate.

Packages

Some items work well together, which is why we've created these special packages. They provide increased convenience and value by combining several of our most popular options.

Order Code		A7	A7 SE	A7 S line	A7 Black Edition	S7	Basic RRP	Total RRP inc VAT
WB4	<p>Technology package Featuring MMI Navigation Plus with MMI Touch, Head-up display, colour Driver's Information System (DIS), and mobile telephone preparation – High with Audi connect</p> <p>MMI Navigation Plus (PNQ). Includes HDD-based navigation with topographical map display, places of interest and town models in 3D. Destinations can be entered via the speech dialogue system or MMI touch. Also includes DVD player and 2 SDHC memory card readers</p> <p>Driver's Information System (DIS) with 7" colour display (9Q8). High resolution TFT colour display in the direct field of view of the driver. It displays information from driver assistance systems, rest recommendation, media in use, telephone menu, gear, outside temperature and other display contents of the MMI, such as night vision assistant (if optionally selected)</p> <p>Head-up display (KS1). Projects driving-related information directly into the driver's field of vision using an optical system of mirrors</p> <p>Mobile telephone preparation – High with Audi connect (9ZW). Audi connect provides access to a number of innovative online services via an internal UMTS (3G) module. Audi connect online services include: navigation using Google Earth images and Google Street View, destination entry via Google Maps or myAudi, online point of interest search and information services such as weather forecasts and the latest world news. Audi connect can also create a Wi-Fi hotspot in the car for convenient internet access using a mobile device (e.g. laptop or tablet). Please see page 65 for a full description of this option including functionality and compatibility details</p> <p>For more details see pages 64, 65 and 66. On entry trim, only in combination with Audi Music Interface (UF7)</p>	●	–	–	–	–	£2,050.00	£2,460.00
	<p>Technology package advanced Includes all the features of Technology package (WB4) as well as adaptive cruise control and the Audi pre-sense plus safety package (PCN), which, in a situation where a collision is inevitable, enables full brake application to avoid or lessen the impact of the collision</p> <p>Audi adaptive cruise control with Stop&Go function including pre-sense front (PCG). Automatic distance regulation, using radar sensors to maintain the required distance between vehicles by braking and accelerating. Works at speeds between 0 and 150mph*</p> <p>Audi side assist including pre-sense rear (PCH). Aids the driver when changing lane. The system monitors the area behind the car, using radar sensors located discreetly in the rear bumper, informing the driver with a visual warning signal in the door mirror if there is a vehicle in their blind spot or approaching quickly from behind</p> <p>Audi lane assist (PCB). Helps the driver to stay in lane with gentle steering impulses for greater safety and convenience.</p> <p>Exterior mirrors (6XF). Heated, electrically adjustable and electrically folding, with automatic kerb view function which tilts the passenger mirror downwards towards the kerb when reverse gear is engaged. Includes memory function</p> <p>For more details please see pages 70, 71 and 72</p>	–	●	●	●	●	£3,125.00	£3,750.00
WB1 PS8	<p>Comfort package Featuring Audi parking system advanced (rear-view camera), advanced key and electrically adjustable Comfort seats with memory function</p> <p>Audi parking system advanced (KA2). Uses a rear-view camera to display the area behind the car on the MMI unit when reversing. Also includes steering path</p> <p>Advanced key (4F2). Allows the driver to keep their key in their pocket or bag at all times. To unlock and open you simply lift the exterior door handle. The door is locked by pressing the button on the handle</p> <p>Electrically adjustable Comfort front seats with memory function (P58). The front seats have 18-way electrical adjustment and include a memory function for both front seats and mirrors. Also includes electrically adjustable 4-way lumbar support</p> <p>For more details please see pages 40, 72 and 74</p>	–	●	–	–	–	£1,458.33	£1,750.00

Options are subject to availability and may extend delivery.

- = Not available
- = Available
- S = Standard

RRP – Recommended Retail Price.

*Where the law permits.

VAT is calculated at 20% but this may alter to reflect any change in the applicable VAT rate.

Packages

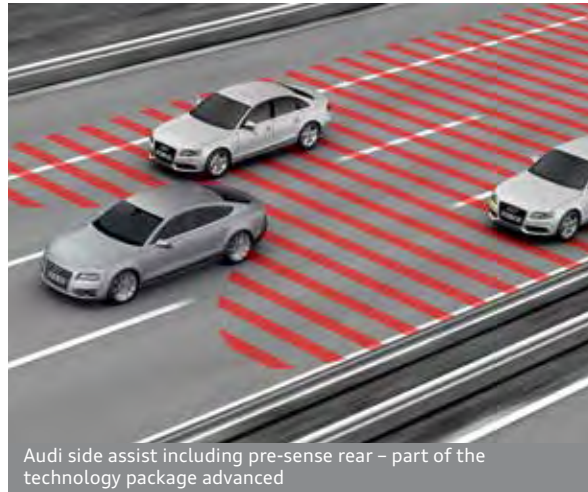

Audio and communication

Stay in touch using our range of communication functions, and give each journey its own soundtrack with our advanced audio equipment.

Options are subject to availability and may extend delivery.

- = Not available
• = Available
S = Standard

RRP – Recommended Retail Price.

VAT is calculated at 20% but this may alter to reflect any change in the applicable VAT rate.

Order Code	A7	A7 SE	A7 S line	A7 Black Edition	S7	Basic RRP	Total RRP inc VAT
8RY BOSE® surround sound - 14 speakers including centre speaker in the dashboard and subwoofer in the spare wheel well - 12-channel amplifier with a total output of over 600 Watts - Acoustics specially tuned to the interior - Surround sound 5.1 reproduction (in conjunction with MMI Navigation Plus) and stereo recordings (CD, radio, MP3) - Audiopilot for noise-compensating volume adjustment - Powerful, precise bass reproduction	•	•	•	S	•	£833.33	£1,000.00
8RF Bang & Olufsen Advanced Sound System - 15 speakers including subwoofer and centre speaker, each with their own amplifier channel for genuine 5.1 surround sound - 10-channel Digital Sound Processing (DSP) full-digital amplifier with a total output of over 1,200 Watts, fully digitised and highly efficient 5-channel ICEPower amplifier for woofers and subwoofer - When switched on, two acoustic lenses extend from the dashboard for excellent sound rendition and perspective from all seats - Polished aluminium speaker covers - Acoustics specially tuned to the interior through the targeted use of tweeters, mid-range speakers and woofers - Speakers in encapsulated housings isolate music and telephone conversations within the vehicle for privacy when making phone calls in handsfree mode - Automatic adjustment of volume to the driving situation Only in combination with MMI Navigation Plus (PNQ/WB4/WB7)	•	•	•	•	•	£5,250.00	£6,300.00
PNQ MMI Navigation Plus including MMI Touch. Hard disk navigation with topographical map display, places of interest and town models in 3D. Destinations can be entered via the speech dialogue system or MMI Touch. The system offers 3 alternative routes, with the ability to scroll along the selected route and manoeuvre within the map. Includes 8" screen with split-screen mode for route information, dynamic route guidance (TMC), intersection zoom function, motorway exits and lane recommendations in colour Driver's Information System (9QB). Incorporates MPEG4-compatible DVD player and two SDHC memory card readers (for cards of up to 32GB). Also allows DAB radio to receive DAB+ and DMB audio signals. Adapts lights, transmission and adaptive cruise control (if fitted) to the road conditions – for example, bends in the road, motorways, intersections and urban areas – even when navigation is deactivated. On entry trim, only in combination with Audi Music Interface (UF7)	•	•	•	•	–	£979.17	£1,175.00
	–	–	–	–	•	£625.00	£750.00



BOSE surround sound



Bang & Olufsen Advanced Sound System

Audio and communication

Options are subject to availability and may extend delivery.

- = Not available
- = Available
- S = Standard

¹Online services are only available for mobile phone contracts or SIM cards which include a data option and only within the coverage of the mobile phone network; there may be additional costs for the use of these services (charges and billing correspond to the personal mobile phone contract or SIM card contract). Due to high data volumes, a mobile phone contract including an unlimited or high usage data plan is strongly recommended. The content and scope of the online based services offered may vary.

²To check the compatibility of your mobile phone and whether it has SIM Access Profile compatibility, please visit www.audi.co.uk/owners-area/phonecompatibility.html

RRP – Recommended Retail Price.

VAT is calculated at 20% but this may alter to reflect any change in the applicable VAT rate.

Order Code		A7	A7 SE	A7 S line	A7 Black Edition	S7	Basic RRP	Total RRP inc VAT
KS1	<p>Head-up display. An optical system of mirrors projects driving-related information directly into the driver's field of vision. To prevent ghost images, a special windscreen with a wedge-shaped film is fitted. Measuring approx. 26 x 9cm in size, the driver perceives the display to be 2 to 2.5m beyond the windscreen. This display has many benefits:</p> <ul style="list-style-type: none"> - Helps to increase safety, convenience and driving pleasure - Straightforward operation via MMI - Display is height-adjustable, adjusts to ambient brightness - High resolution of up to 480 x 240 pixels <p>The following are displayed, however some are dependent on additional options being chosen:</p> <ul style="list-style-type: none"> - Road speed - Navigation instructions - Adaptive cruise control status, distance from vehicle ahead and set speed (optional) - Warning messages from optional night vision assistant (optional) - Infotainment lists - Audi active lane assist (optional) - Speed limit display (optional) 	•	•	•	•	•	£1,033.33	£1,240.00
9ZW	<p>Mobile telephone preparation – High, with Audi Connect. Audi connect provides access to a number of innovative online services via an internal UMTS (3G) module. Audi connect online services include: navigation using Google Earth images and Google Street View, destination entry via Google Maps or myAudi, online point of interest search and information services such as weather forecasts and the latest world news. Audi connect also includes Audi traffic information online, which gives accurate real-time forecasts of the traffic situation along the chosen route. The traffic situation can be displayed on the navigation map or Google Earth image. Audi connect can also create a Wi-Fi hotspot in the car for convenient internet access using a mobile device (e.g. laptop or tablet). Many Audi connect features can be simply operated via MMI, the multi-function steering wheel or the voice control system. Only in combination with MMI Navigation Plus (PNQ) or as part of the Technology packages (WB4/WB7)</p> <p>Important connectivity information: An external data source is required to enable the Audi connect online services. One of the two following external data sources can be used¹:</p> <ol style="list-style-type: none"> 1. A mobile telephone with Bluetooth SIM Access Profile² 2. A separate SIM card which can be inserted in the included SIM card reader. When a separate SIM card is used, hands free phone calls are possible using the SIM card or by connecting a different mobile telephone via Bluetooth Hands Free Profile 	•	•	•	•	•	£291.67	£350.00



MMI Navigation Plus including MMI Touch



Head-up display

Audio and communication

Order Code		A7	A7 SE	A7 S line	A7 Black Edition	S7	Basic RRP	Total RRP inc VAT
6G0	DVD/CD changer in glove compartment, for 6 DVDs or CDs, supports audio CDs, video DVDs, MP3, WMA, AAC, MPEG-4 and playlists as well as UDF file system (Windows Vista); supports up to 4,000 tracks per medium; shock-resistant and easily accessible in the glove compartment. Only in combination with MMI Navigation Plus (PNQ/WB4/WB7)	●	●	●	●	●	£366.67	£440.00
QU6	Digital TV reception. Reception of digital (DVB-T) uncoded television stations (MPEG-2 standard), TV picture, teletext and Electronic Programme Guide (EPG). Facility to connect 2 external AV sources via adaptor cables (available from Audi Genuine Accessories). Please note: TV reception depends on local digital network availability. No AV or TV video output when driving (only audio output available when driving). Only in combination with MMI Navigation Plus (PNQ/WB4/WB7)	●	●	●	●	●	£725.00	£870.00
9WQ	Audi Entertainment Mobile. Rear seat entertainment system includes two 9" screens* supplied by Audi Genuine Accessories. These can be easily fitted and connect to modern storage devices such as Bluetooth interface, CD/DVD-drive, SD-card slot, USB-interface and AV-IN/OUT. Includes a carry case for player and accessories, remote control, table-top stand, battery for 2.5 hours' external player time, charging lead, head phones, operating instructions and a bonus DVD. The back of both front seats are fitted with mountings and wiring and the system can also be used outside the car with the rechargeable battery. Not available in combination with Super Sports seats (Q4Q)	●	●	●	●	●	£875.00	£1,050.00
UF7	Audi Music Interface universal connection for use with stereo audio sources, USB and MP3 devices including Apple iPod generation 4 onwards (iPod, iPod classic, iPod mini, iPod nano, iPod photo, iPod video, iPod Touch). Provides intuitive control through the audio system and multi-function steering wheel. It also replicates the iPod display on the audio screen and DIS, including track titles. The interface provides charging function (dependent on device). Includes 2 cables to connect your iPod or USB MP3 player device	●	S	S	S	S	£216.67	£260.00
9Q8	Colour Driver's Information System including 7" high resolution TFT colour display in the direct field of view of the driver. It displays information from driver assistance systems, rest recommendation, media in use, telephone menu, gear, outside temperature and other display contents of the MMI, such as night vision assistant (if optionally selected). The integral efficiency program provides assistance in the form of consumption data overviews, a display of additional consumers and fuel-saving tips for a more economical driving style; very clearly arranged with easily readable header and status lines (tab concept) and automatic brightness adjustment. Operated via a multi-function leather steering wheel	●	S	S	S	S	£341.67	£410.00

Options are subject to availability and may extend delivery.

- = Not available
- = Available
- S = Standard

*Screens must be ordered by your local Audi Centre via Audi Genuine Accessories.

RRP – Recommended Retail Price.

VAT is calculated at 20% but this may alter to reflect any change in the applicable VAT rate.



Interior equipment

Specify every detail of your car's interior with this range of exclusive options.

Order Code		A7	A7 SE	A7 S line	A7 Black Edition	S7	Basic RRP	Total RRP inc VAT
QQ1	Lighting package. Interior includes entrance lighting and LED lighting for front footwell, inside door handles, vanity mirror lights and centre console storage compartment. Also includes ambient lighting for the centre console and ambient reflected light for interior door trim. Exterior includes courtesy lighting under the door handles and LED-illuminated handle recess for easy entry in the dark (automatically activated when the doors are unlocked)	●	S	S	S	S	£245.83	£295.00
QQ2	Ambient lighting. Including anti-glare illumination for the passenger compartment with LED technology. Lighting for door pockets, footwells and inside door handles, reflected lighting for centre console and door inner panels to help occupants find their way around. Surround lighting for centre console (floating effect), make-up lights at front and active door reflectors, with illuminated door sill trims (please note this will delete S line or S7 logo). Configured via MMI System	●	—	—	—	—	£495.83	£595.00
		—	●	●	●	●	£250.00	£300.00
9AQ	Deluxe 4-zone automatic climate control. In addition to standard automatic air conditioning, this features a digital display control panel, separate temperature control for driver, front passenger and rear passengers; additional air conditioning controls with digital display for climate control in the rear with separately adjustable temperature and blower settings and air distribution for the right and left-hand sides (rear functions can also be set from the front air conditioning controls). It also comes with additional air vents in the B pillars; automatic recirculation mode by means of air quality sensor, use of residual heat, separate regulation of footwell temperature, ventilated glove compartment. Choice of 3 settings: gentle, medium, intensive	●	●	●	●	S	£516.67	£620.00
2C7	Electrically adjustable steering column. Adjustable for height and reach with auto easy-entry and exit function. On entry trim, only in combination with electrically adjustable front seats (PV3/PS8) and cruise control (8T1/PCN/PCG)	●	●	●	●	●	£350.00	£420.00
6NQ	Cloth headlining – black. On entry and SE trim, only available in combination with interior colours FZ and VB	●	●	S	S	●	£225.00	£270.00
PAC	Storage package including tie-down straps. Consisting of 2 drinks holders in the rear centre armrest, luggage net for luggage compartment and 2 12-Volt sockets in the rear	●	●	●	●	S	£87.50	£105.00
7HB	Extended leather package with lower part of centre console, armrests in the doors and door-pull handles in leather. Only in combination with Milano leather	●	●	—	—	—	£429.17	£515.00
7HE	Leather covered door armrests. Only in combination with Valcona leather	●	●	●	●	●	£279.19	£335.00
6SJ	Reversible luggage compartment mat. Velour on one side, rubber on the other. Folds out to cover the luggage compartment, even with the rear seats folded down	●	●	●	●	●	£91.67	£110.00
3X2	Through-load facility with removable ski/snowboard bag. For practical and safe transportation of long objects, e.g. up to 4 pairs of skis or 2 snowboards; unrestricted use of the rear seats	●	●	●	●	●	£175.00	£210.00
3Y6	Manual blind for rear window	●	●	●	●	●	£112.50	£135.00
9JC	Smoking package cigarette lighter and ashtray	●	●	●	●	●	No charge	No charge

Options are subject to availability and may extend delivery.

— = Not available
● = Available
S = Standard

RRP – Recommended Retail Price.

VAT is calculated at 20% but this may alter to reflect any change in the applicable VAT rate.



Exterior equipment

Make sure your car looks exactly as you want it to by selecting some of our striking options.

Order Code		A7	A7 SE	A7 S line	A7 Black Edition	S7	Basic RRP	Total RRP inc VAT
6XF	Exterior mirrors – heated, electrically adjustable and folding, with automatic kerb view function which tilts the passenger mirror downwards towards the kerb when reverse gear is engaged. Includes memory function. On entry trim, only in combination with electric front seats (PV3/PS8)	●	●	●	●	●	£195.83	£235.00
	In combination with Technology package advanced (WB7)	–	●	●	●	●	No charge	No charge
6XM	Exterior mirrors – heated, electrically adjustable and auto-dimming, with automatic kerb view function which tilts the passenger mirror downwards towards the kerb when reverse gear is engaged. Includes memory function. On entry trim, only in combination with electric front seats (PV3/PS8)	●	●	●	●	●	£229.17	£275.00
6XL	Exterior mirrors – heated, electrically adjustable, electrically folding and auto-dimming, with automatic kerb view function which tilts the passenger mirror downwards towards the kerb when reverse gear is engaged. Includes memory function. On entry trim, only in combination with electric front seats (PV3/PS8)	●	●	●	●	●	£429.17	£515.00
	In combination with Technology package advanced (WB7)	–	●	●	●	●	£233.33	£280.00
GZ2	Power door closure. Automatically pulls doors that are not completely engaged into the lock	●	●	●	●	●	£362.50	£435.00
4KF	Privacy glass. Dark tinted rear and rear-side windows (from B pillar backwards) - Windscreen in heat/sound insulating glass - Front side windows in standard glass (single-layer safety glass) - Rear side windows in standard glass (single-layer safety glass) with privacy glass - Rear window in standard glass (single-layer safety glass) with privacy glass	●	●	●	S	●	£325.00	£390.00
PDW	Heat/sound-insulating glass with privacy glass - Windscreen in heat/sound-insulating glass with visible vehicle identification number. Also includes a clear area in the upper section of the driver's side windscreen for toll road pass tags - Front side windows in heat/sound-insulating glass - Rear side windows in standard glass (single-layer safety glass) with privacy glass - Rear window in standard glass (single-layer safety glass) with privacy glass	●	●	●	●	●	£708.33	£850.00
PDV	Heat/sound-insulating glass - Windscreen in heat/sound-insulating glass with visible vehicle identification number. Also includes a clear area in the upper section of the driver's side windscreen for toll road pass tags - Front side windows in heat/sound-insulating glass - Rear side windows in heat/sound-insulating glass - Rear window in standard glass (single-layer safety glass)	●	●	●	–	●	£875.00	£1,050.00
3FE	Slide-and-tilt sunroof with tinted single-glazed safety glass and infinitely adjustable sun shield, integral wind deflector, and convenient closing from outside via the central locking and the radio-operated remote control	●	●	●	●	●	£791.67	£950.00
1D4	Towing bar. Ball head and ball joint coupling made from forged steel. Mechanically swivelling ball head, operated via Bowden cable, with indicator light on Bowden cable and display in instrument cluster to monitor secure attachment of trailer towing hitch. Includes trailer stabilisation system via the Electronic Stability Control (ESC). Includes single European 13-pin electric socket and may require a 13- to 7-pin adaptor. Please consult your Audi Centre for details*	●	●	●	●	●	£854.17	£1,025.00
4ZD	Black styling package. Includes radiator grille frame and radiator grille struts in high-gloss black, radar sensor surrounds (if fitted) in the side ventilation grille in high-gloss black, radiator grille in matt black, front side grilles in matt black, number plate holder in matt black, window capping strips and side profile roof trim strip in high-gloss black	●	●	●	S	–	£537.50	£645.00
2Z0	Deletion of model designation, engine technology and quattro badges at rear	●	●	●	●	●	No charge	No charge
2Z7	Deletion of model designation and quattro badges at rear	●	●	●	●	–	No charge	No charge

Options are subject to availability and may extend delivery.

– = Not available
● = Available
S = Standard

*Additional wiring is required for auxiliary equipment.

RRP – Recommended Retail Price.

VAT is calculated at 20% but this may alter to reflect any change in the applicable VAT rate.

Safety and security

Intelligent technology designed to give you better all-round awareness and safety on the road.

Options are subject to availability and may extend delivery.

*Where the law permits.

- = Not available
 • = Available
 S = Standard

RRP – Recommended Retail Price.

VAT is calculated at 20% but this may alter to reflect any change in the applicable VAT rate.

Order Code		A7	A7 SE	A7 S line	A7 Black Edition	S7	Basic RRP	Total RRP inc VAT
PCB	Audi active lane assist helps the driver to stay in lane with gentle steering impulses for greater safety and convenience, particularly on motorways and country roads: - Informs driver if car is drifting out of lane unintentionally above approximately 37mph - Driver has the choice of two system settings in the MMI: - early steering intervention: continuously helps the driver to stay in lane with steering impulses that centre the vehicle in its lane - late steering intervention: alerts the driver that the vehicle is possibly crossing the lane markings at the same time as providing a corrective steering prompt - Additional warning via vibrating steering wheel when lane markings are crossed, if specified by driver - Camera identifies individual or coloured lane markings, e.g. yellow lines at roadworks - Additional indication in head-up display (if selected as an option)	•	•	•	•	•	£333.33	£400.00
7W1	Pre-sense basic networks the different vehicle systems, enabling driving situations to be categorised and, where necessary, actions to be implemented to protect passengers. These include: belt tightening, activating the hazard warning system, closing the windows and – if fitted – sliding roof	•	•	•	•	•	£216.67	£260.00
8T1	Cruise control. Maintains any speed above 18mph, provided that the engine power output and engine braking effect permit it. Operated via separate steering column stalk, set speed displayed in Driver's Information System (DIS)	•	S	S	S	S	£237.50	£285.00
PCG	Adaptive cruise control (ACC) with Stop&Go function including pre-sense front. Automatic distance regulation, using radar sensors to maintain required distance by braking and accelerating. Four programs (distance 1 to distance 4) set via steering column controls of the cruise control system. Works at speeds between 0 and 150mph* and also includes Audi braking guard – a system which triggers a visual and acoustic alarm when it detects the risk of a rear end collision with the vehicle in front. In addition, the airbags are pre-conditioned if a crash is sensed and the braking system is prepared to assist with the necessary braking force once the brake pedal is touched. On entry trim, only in combination with colour Driver's Information System (9Q8) and Audi parking system plus (7X2) or Park assist (7X5)	•	-	-	-	-	£1,341.67	£1,610.00
		-	•	•	•	-	£1,108.33	£1,330.00
		-	-	-	-	•	£650.00	£780.00

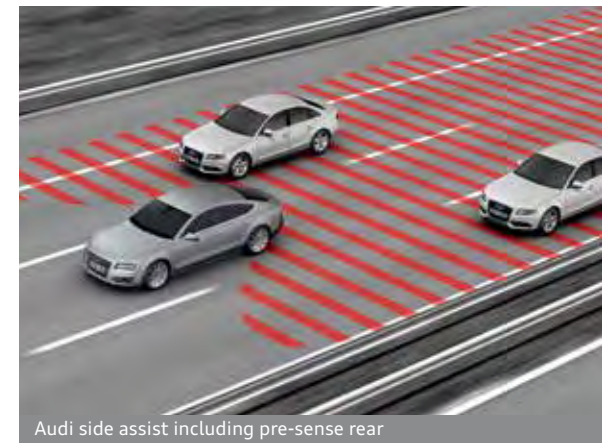
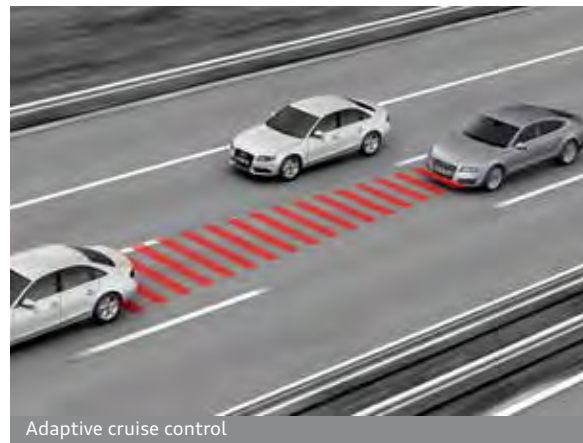
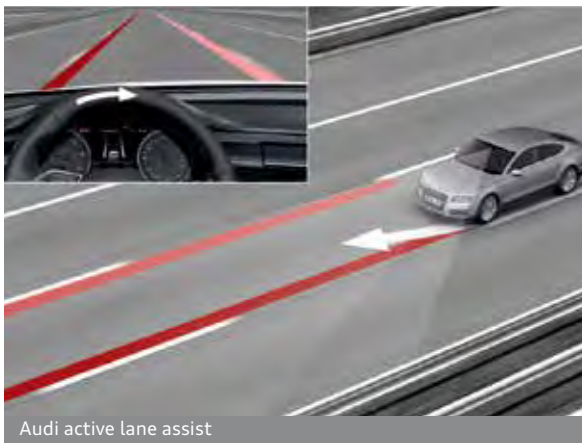

Safety and security

Order Code		A7	A7 SE	A7 S line	A7 Black Edition	S7	Basic RRP	Total RRP inc VAT
PCH	Audi side assist including pre-sense rear. Aids the driver when changing lane. Audi side assist monitors the area behind your car, using radar sensors located discreetly in the rear bumper, informing the driver with a visual warning signal in the door mirror if there is a vehicle in their blind spot or approaching quickly from behind. The system is activated using a button in the driver's door and works at speeds above 19mph. If a rear collision is sensed, the upper backrest and headrest are adjusted automatically (where memory seats are fitted) to provide more protection. If Comfort front seats or Comfort front Sports seats are also selected, the pneumatic bolsters are filled to provide extra protection. In addition, the airbags are pre-conditioned. Only in combination with electrically folding mirrors (6XL/6XF) and on entry trim must also be combined with electrically adjustable front seats (PV3/PS8)	•	•	•	•	•	£437.50	£525.00
PCN	Adaptive cruise control with Stop&Go function, Audi side assist and Audi active lane assist with pre-sense plus. Only in combination with electrically folding door mirrors (6XL/F). On entry trim, only in combination with electrically adjustable front seats (PV3/PS8), colour Driver's Information System (9Q8) and parking system plus (7X2/7X5)	•	•	•	•	•	£1,775.00	£2,130.00
PCD	Audi side assist including pre-sense rear and Audi active lane assist. Only in combination with electrically folding door mirrors (6XL/6XF) and on entry trim, only in combination with electrically adjustable front seats (PV3/PS8)	•	•	•	•	•	£770.83	£925.00
QR9	Speed limit display via the Driver's Information System (DIS). Should the camera fail to see a sign properly, the speed limit from the data for the navigation system will be shown instead. The specific advantages: - Display of the speed limits currently registered, which can be called up in the Driver's Information System at any time - Display can be called up in every instrument cluster view and in the head-up display (optionally available) - Camera-based system is also capable of detecting temporary speed restrictions in roadworks and on digital displays (e.g. over motorways) within the system limits - Display of national speed limits for Western European countries Only in combination with MMI Navigation Plus (PNQ/WB4/WB7), and with active lane assist (PCB), Audi side assist (PCD), or adaptive cruise control (PCG/PCN)	•	•	•	•	•	£208.33	£250.00
4X4	Rear side airbags. For the outer rear seats, incorporated into the seat backrests. Supplement the side impact protection in the doors and the head airbag system	•	•	•	•	•	£312.50	£375.00
1T3	First aid kit in the storage compartment of the rear centre armrest	•	•	•	•	S	£25.00	£30.00
VC1	Garage door opener (HomeLink®*). Programmable radio-operated remote control for compatible doors/gates. Control buttons integrated in the front roof module	•	•	•	•	•	£204.17	£245.00
PGD	Advanced key. Access and authorisation system that works through automatic data exchange between key and vehicle, allowing the driver to keep their car key in their pocket or bag at all times. To unlock and open, simply lift the exterior door handle. The door is locked by pressing the button on the handle. Pressing the start/stop button integrated in the centre console starts and stops the engine. Also featured is a hands-free tailgate release sensor located underneath the rear bumper, which can be operated by a simple kicking movement underneath the sensor	•	•	•	•	•	£566.67	£680.00
8N7	High-beam assist. Variable headlight range control featuring a camera on the interior mirror which registers sources of light from other road users. The range and width of the headlight beam are continuously varied between dipped and main beam to suit ambient conditions, ensuring that the headlights provide good visibility without dazzling other road users	•	•	•	•	•	£116.67	£140.00
OM5	75-litre fuel tank	•	•	•	•	S	£95.83	£115.00

Options are subject to availability and may extend delivery.

- = Not available
• = Available
S = Standard

*Homelink® is a registered trademark of Johnson Controls. For information on compatibility, visit www.homelink.com.

RRP – Recommended Retail Price.

VAT is calculated at 20% but this may alter to reflect any change in the applicable VAT rate.

Safety and security

Intelligent technology designed to give you better all-round awareness and safety on the road.

Options are subject to availability and may extend delivery.

- = Not available
- = Available
- S = Standard

RRP – Recommended Retail Price.

VAT is calculated at 20% but this may alter to reflect any change in the applicable VAT rate.

Order Code	A7	A7 SE	A7 S line	A7 Black Edition	S7	Basic RRP	Total RRP inc VAT
PXB	•	•	•	•	•	£500.00	£600.00
PX2	•	•	•	•	•	£1,416.67	£1,700.00
9R1	•	•	•	•	•	£1,258.33	£1,510.00

Adaptive light and high-beam assist. Includes swivelling headlights for improved illumination of a winding road, and dynamic cornering light function which pivots the headlights based on the movement of the steering wheel (operational between speeds of approximately 6mph and 68mph). Turning light function is activated when indicator is switched on (up to speeds of 45mph). The headlights have three different light distribution modes: town light, motorway light, or country light, which are adjusted according to speed or via navigation route data (if fitted with MMI navigation plus with MMI touch – PNQ). Additional functionality via navigation-based vehicle support includes junction light, which provides a wide front light setting, as well as travel mode, which switches between right and left-hand drive modes assisted by GPS data. High-beam assist automatically adjusts headlights from high-beam to dipped-beam when another vehicle is approaching or when other ambient lighting is detected (i.e. street lights) by a camera on the interior mirror. Not available in combination with all-LED headlights (PX2)

All-LED headlights including high-beam assist. LEDs for all front lighting functions. LED technology provides lower energy consumption and enhanced contrast with a colour similar to daylight, for increased safety and good recognition by other road users. Includes all-weather light function to reduce the risk of the driver being dazzled when visibility is poor (in fog, rain or snow), turning-light function which is activated when indicator is switched on (up to speeds of 45mph), and an additional motorway light which automatically increases headlight range at speeds above approximately 68mph. Also includes high-beam assist which automatically adjusts headlights from high-beam to dipped-beam when another vehicle is approaching or when other ambient lighting is detected (i.e. street lights) by a camera on the interior mirror. Not available in combination with Adaptive headlights and high-beam assist (PXB)

Night vision assistant with pedestrian detection. A thermal imaging camera (remote infrared with resolution of 320 x 240 pixels) registers heat dissipation in front of the vehicle and represents this image in the Driver's Information System (DIS). Image recognition software highlights people detected in the darkness in yellow, and if the system classifies them as being at risk, a warning bell is sounded and the image changes to red. If combined with Adaptive light and high-beam assist (PXB), the person detected is also illuminated by the headlights three times in succession to alert them to the danger. Warning can also be shown in the Head-up display (KS1) if ordered. System operation may be restricted in too much ambient light, high humidity and high night temperatures (over 28°C). On entry trim, only in combination with colour Driver's Information System (9Q8)



Adaptive light and high-beam assist



Night vision assistant with pedestrian detection

Safety and security

Intelligent technology designed to give you better all-round awareness and safety on the road.

Options are subject to availability and may extend delivery.

- = Not available
- = Available
- S = Standard

RRP – Recommended Retail Price.

VAT is calculated at 20% but this may alter to reflect any change in the applicable VAT rate.

Order Code		A7	A7 SE	A7 S line	A7 Black Edition	S7	Basic RRP	Total RRP inc VAT
7X2	Audi parking system plus – acoustic and visual park assist system for the front and rear with MMI screen display. Measurement is by ultrasonic sensors concealed in the bumpers	•	S	S	S	S	£416.67	£500.00
7X5	Park assist searches for suitable parking spaces along the road by means of ultrasonic sensors, calculates the ideal parking path and performs the steering action virtually automatically. Steering is done by the vehicle – the driver just needs to accelerate and apply the brakes	•	-	-	-	-	£1,025.00	£1,230.00
KA2	Audi parking system advanced with reversing camera . An image of the area behind the vehicle is shown on the MMI display, with dynamic display modes showing the calculated path (steer-angle dependent); includes help lines, guidelines and identification of the point at which to apply opposite lock when parallel parking. The reversing camera is concealed in the handle strip of the tailgate. Also available as part of the Comfort package (WB1). On entry trim, only in combination with Audi parking system plus (7X2) or Park assist (7X5)	•	•	•	•	•	£333.33	£400.00
KA4	Audi parking system advanced with corner-view camera . Aids parking and manoeuvring, with the help of guiding lines, providing a reversing camera concealed in the handle of the luggage compartment lid, and additional display modes for the front-left and right, and rear-left and right. Only available in combination with MMI plus (PNQ/WB4/WB7). On entry trim, only in combination with Audi parking system plus (7X2) or Park assist (7X5)	•	•	•	•	•	£541.67	£650.00



Steering wheels

Order Code		A7	A7 SE	A7 S line	A7 Black Edition	S7	Basic RRP	Total RRP inc VAT
2ZM	4-spoke leather-trimmed multi-function steering wheel – heated (no paddles). On entry trim, only in combination with cruise control (8T1)	●	●	–	–	–	£33.33	£40.00
1XX	3-spoke leather-trimmed multi-function Sports steering wheel – with paddles	●	●	S	S	S	£95.83	£115.00
1XT	3-spoke leather-trimmed multi-function Sports steering wheel – heated and with paddles. On entry trim, only in combination with cruise control (8T1)	–	–	●	●	●	£262.50	£315.00
		–	–	●	●	●	£166.67	£200.00

Options are subject to availability and may extend delivery.

- = Not available
- = Available
- S = Standard

RRP – Recommended Retail Price.

VAT is calculated at 20% but this may alter to reflect any change in the applicable VAT rate



Looking after your Audi

When you've chosen your ideal model, it's reassuring to know that it will remain in safe hands. That's why we've created products to protect your Audi, from extended warranties to Audi Complete – our comprehensive service and maintenance package. And there's also a range of Audi accessories and merchandise to choose from, enabling you to further enhance and safeguard your car.





Audi Complete

Audi Complete is simply a way to look after the servicing and maintenance costs for your Audi in a single package. You pay a one-off or monthly fee and we'll cover all your servicing, maintenance and tyres for the next three years, including your MOT. It means you only have to pay for fuel, insurance and your Road Fund Licence. So you can be reassured that your car will be maintained by trained Audi Technicians, using genuine Audi parts. You can also opt for our Service only or Service and Maintenance packages if you prefer.

*Retail customers only. Pricing correct at time of print and based on a 3 years/30,000 miles agreement. All pricing is a 'starting from' price for the Audi A7 model range and is therefore subject to change and mileage/ model dependent. If you drive under 10,000 miles per annum your vehicle will be placed on a fixed inspection service schedule. If your mileage tends to exceed 10,000 miles per annum it will be placed on the Flexible Service schedule.

Warranty

Options are subject to availability and may extend delivery.

- = Not available
• = Available
S = Standard

**Only available prior to registration of your new A7. Please speak to your Audi Centre for full details.

RRP - Recommended Retail Price.

VAT is calculated at 20% but this may alter to reflect any change in the applicable VAT rate.

Order Code		A7	S7	Basic RRP	Total RRP inc VAT
-	Audi Complete - Service only. Comprehensive care for your Audi covering all your servicing for 3 years. Visit your local Audi Centre for further information or audi.co.uk/audicomplete for full details including terms and conditions	Monthly Direct Debit	● -	£18.33	£22.00*
		- ●		£27.50	£33.00*
-	Audi Complete - Service and Maintenance. Comprehensive care for your Audi covering all your servicing and maintenance for 3 years, as well as your MOT. Visit your local Audi Centre for further information or audi.co.uk/audicomplete for full details including terms and conditions	Monthly Direct Debit	● -	£24.17	£29.00*
		- ●		£39.17	£47.00*
-	Audi Complete - Service, Maintenance and Tyres. Comprehensive care for your Audi covering all your servicing, maintenance and tyres for 3 years, as well as your MOT. Visit your local Audi Centre for further information or audi.co.uk/audicomplete for full details including terms and conditions	Monthly Direct Debit	● -	£39.17	£47.00*
		- ●		£58.83	£70.00*

Order Code		A7	S7	Basic RRP	Total RRP inc VAT
-	Audi Warranty , covering you for unlimited mileage in the first 2 years of ownership, and up to 60,000 miles in the third year. Transferable between owners**	S	S	No charge	No charge
EA6	Audi Warranty , covering you for up to 4 years or 75,000 miles, whichever comes soonest. Cover includes a 2-year unlimited mileage warranty, and up to 75,000 miles in the third and fourth years. Transferable between owners**	●	●	£608.33	£730.00
EA9	Audi Warranty , covering you for up to 5 years or 90,000 miles, whichever comes soonest. Cover includes a 2-year unlimited mileage warranty, and up to 90,000 miles in the third, fourth and fifth years. Transferable between owners**	●	●	£1,458.33	£1,750.00

Accessories

Choosing an Audi isn't just a matter of deciding on the model you want; it's about creating a car that suits your needs perfectly. That's why we've developed a whole range of accessories to enhance your A7, enabling you to customise it down to the last detail. Like your Audi, all these accessories are developed to the highest possible standards. They're all available exclusively from Audi. To find out more, just visit your local Audi Centre.

Warranty

All the accessories available on the A7 are covered by a 3-year warranty* if they are ordered and included in the purchase price of the car at date of delivery. Any accessories ordered and installed after delivery include a 2-year warranty.*

*Excluding Road Angel products.

Audi Accessories warranty terms and conditions can be found at audi.co.uk



Merchandise

From the enthusiasts' motorsport collection to the sophisticated Audi collection, there's a wide variety of adults' and children's clothing, lifestyle accessories and collectables, all of which bear the Audi name.

Please speak to a member of our team at your local Audi Centre to see the full Audi collection and to place an order. A selection of Audi merchandise is also available to buy from audi.co.uk/merchandise



The Audi **Difference**

The experts in Vorsprung durch Technik

Our Audi Approved Master Technicians have undergone an impressive 100,000 hours of training over a 10-year programme to ensure they have the latest technical expertise for maintaining and servicing your Audi. All our Service Advisors undergo a specialist induction and training to ensure they are Audi professionals and able to talk to you about any issues you may have with your Audi vehicle.

Servicing tailored to your needs

Regular servicing is key to safeguarding your Audi's performance and a full Audi service history could help you enhance the future re-sale value. To make servicing easy, the Audi Service Schedules have been designed to work with your individual driving style and vehicle.

We offer two different schedules: the fixed Inspection Service and the Flexible Service schedule. The conventional fixed Inspection Service schedule has fixed intervals for the Oil-change Service and Inspection Service, which are determined by time and distance.

With the Flexible Service schedule, the Inspection Service intervals are also fixed but the Oil-change Service intervals are variable. Sensors take account of driving style and conditions to determine when the Oil-change Service is required and the driver is informed via the on-board service interval display.

The choice of Service Schedule will depend on journey type and mileage as well as individual driving style and conditions. The table to the right can be used for guidance but your Audi Centre will help you to determine the most suitable Service schedule for you based on your individual circumstances and preferences.

Fixed Inspection Service Schedule

	Vehicle usage:
Mileage	Less than 10,000 miles per annum Mainly city/town centre driving. Short journeys.
	Service Intervals:
Oil-change Service	Fixed to every 9,000+ miles/1 year
Inspection Service	Fixed to every 19,000+ miles/2 years

Flexible Service Schedule

	Vehicle usage:
Mileage	More than 10,000 miles per annum Motorway and main road driving. Mainly longer distance journeys. Constant speeds.
	Service Intervals:
Oil-change Service	Variable to a maximum of every 19,000+ miles/2 years
Inspection Service	Fixed to every 19,000+ miles/2 years

When a vehicle is frequently used in the following conditions, we recommend a Fixed Inspection Service Schedule, regardless of mileage:

Uneconomical driving styles, e.g. heavy acceleration and braking, constant use of high revs

High engine-loading conditions, e.g. frequent towing and hill climbs

*As indicated by the service interval display. Mileages are approximate as the Service Indicator system uses kilometres as its distance measurement.

Your convenience comes first

At Audi you can choose from a range of convenient services that suit your needs. Why not book a 'service while you wait' appointment* and enjoy our complimentary refreshments while your car is with us? Or, if you need to be mobile, take advantage of one of our courtesy cars which we can even deliver to you.* We guarantee we can service your Audi within 5 days without a courtesy car or within 10 days if you need transport. We will also ensure your car is returned to you with a full valet.

Audi Genuine Parts

You can rest assured that only Audi Genuine Parts will be used on your vehicle. What's more, Audi parts and labour come with a 2-year guarantee.**

No hidden costs

We believe strongly in transparency when it comes to our prices. For added peace of mind, we will give you a quotation over the phone for the work you have requested and email you the price confirmation. We'll consult you if any additional work on your car is needed when it is with us. We won't carry out any extra work without asking your permission first.

All part of the service

Whenever we see an Audi for a service, we connect it directly to our headquarters in Ingolstadt which enables us to check your car's software and make sure it's as up-to-date as possible. If the factory has released a software upgrade for your model, it can be applied immediately - improving anything from your car's efficiency to the precision of its parking system.

Audi Roadside Assistance

Your new car comes complete with 3 years' complimentary roadside assistance and recovery across the UK, provided by Automobile Association Insurance Services Limited. Also included is roadside assistance throughout Europe, managed by Automobile Association Insurance Services Limited.

For further information and terms and conditions please visit audi.co.uk

*Subject to availability.

**Excludes wear and tear.



A7 Sportback technical data

Engine	Petrol			Diesel	
	3.0 TFSI quattro	3.0 TDI	3.0 TDI quattro	3.0 TDI quattro	3.0 BiTDI quattro
Transmission	7-speed S tronic	8-speed multitronic	7-speed S tronic	7-speed S tronic	8-speed tiptronic
Cylinder	6-cylinder	6-cylinder	6-cylinder	6-cylinder	6-cylinder
Displacement, cubic cm (valves per cylinder)	2995 (4)	2967 (4)	2967 (4)	2967 (4)	2967 (4)
Max. power, ¹ PS at rpm	310/5250-6500	204/3750-4500	204/3250-4500	245/4000-4500	313/3900-4500
Max. torque, Nm at rpm	440/2900-4500	400/1250-3500	450/1250-3000	580/1400-3250	650/1450-2800
0-62mph acceleration, seconds	5.6	7.4	7.2	6.3	5.3
Top speed, mph	155*	146	146	155*	155*
CO ₂ emissions, ² g/km	190	135	152	156	166
Benefit in kind (BIK)%	31%	23%	26%	27%	29%
Fuel consumption ² , mpg (l/100km) Urban	26.2 (10.8)	47.9 (5.9)	41.5 (6.8)	39.2 (7.2)	35.8 (7.9)
Fuel consumption ² , mpg (l/100km) Extra Urban	42.8 (6.6)	60.1 (4.7)	55.4 (5.1)	54.3 (5.2)	51.4 (5.5)
Fuel consumption ² , mpg (l/100km) Combined	34.4 (8.2)	55.4 (5.1)	48.7 (5.8)	47.9 (5.9)	44.8 (6.3)
ABI insurance group 1-50 ⁺	41 E	34 E	36 E	41 E	42 E
Unladen weight, ³ kg	1785	1695	1785	1785	1850
Gross weight limit, kg	2395	2305	2395	2395	2460
Roof load limit/nose weight, kg	100/85	100/85	100/85	100/85	100/85
Max trailer load unbraked, ⁴ kg	750	750	750	750	750
Max trailer load with 12% gradient, ⁴ kg	2100	1800	1800	2000	2100
Max trailer load with 8% gradient, ⁴ kg	2100	1900	1900	2100	2100
Luggage compartment capacity, rear seats upright, litres	535	535	535	535	535
Luggage compartment capacity, rear seats folded, litres	1390**	1390**	1390**	1390**	1390**
Fuel tank capacity approx, litres	65	65	65	65	65
Emission standard	EU5	EU5	EU5	EU5	EU5

*Electronically limited

**Loaded up to roof with rear seat folded down.

⁺Highest insurance group rating shown. Group may be lower dependent on trim level. Please visit www.thatcham.org/abigrouprating for details.

¹The given value was obtained in accordance with the specified measurement procedure (the respective current version of the Directive 80/1269/EEC).

²Fuel consumption and CO₂ emissions figures are obtained under standardised test conditions (Directive 93/116/EEC) using a representative model. This allows direct comparison between different models from different manufacturers, but may not represent the actual fuel consumption achieved in 'real world' driving conditions. More information is available at www.vca.gov.uk

³Vehicle's unladen weight without driver (calculated in accordance with the current version of Directive 80/1268/EEC). The fitting of additional equipment may increase the vehicle's unladen weight and drag coefficient, whereupon the potential carrying capacity and top speed will be correspondingly reduced.

⁴The engine's power output always goes down with increasing altitude. At 1,000m above sea level, and for every additional 1,000m, deduct 10% from the weight of the outfit (trailer load limit + gross weight of the towing vehicle).

Please note: The maximum power output figures are quoted in PS (or Pferdestärke, which is the metric equivalent of brake horsepower). To convert to brake horsepower, divide the PS figure by 1.0139.

S7 Sportback technical data

Petrol

Engine	4.0 TFSI quattro
Transmission	7-speed S tronic
Cylinder	V8
Displacement, cubic cm (valves per cylinder)	3993
Max. power, ¹ PS at rpm	420/5500-6400
Max. torque, Nm at rpm	550 /1400-5200
0-62mph acceleration, seconds	4.7
Top speed, mph	155*
CO ₂ emissions, ² g/km	225
Benefit in kind (BIK)%	35%
Fuel consumption ² , mpg (l/100km) Urban	21.1 (13.4)
Fuel consumption ² , mpg (l/100km) Extra Urban	37.7 (7.5)
Fuel consumption ² , mpg (l/100km) Combined	29.4 (9.6)
ABI insurance group 1-50 [†]	44 E
Unladen weight, ³ kg	1945
Gross weight limit, kg	2555
Roof load limit/nose weight, kg	100/85
Max trailer load unbraked, ⁴ kg	750
Max trailer load with 12% gradient, ⁴ kg	2100
Max trailer load with 8% gradient, ⁴ kg	2100
Luggage compartment capacity, rear seats upright, litres	535
Luggage compartment capacity, rear seats folded, litres	1390**
Fuel tank capacity approx, litres	75
Emission standard	EU5

*Electronically limited

**Loaded up to roof with rear seat folded down.

†Highest insurance group rating shown. Group may be lower dependent on trim level. Please visit www.thatcham.org/abigrouprating for details.

¹The given value was obtained in accordance with the specified measurement procedure (the respective current version of the Directive 80/1269/EEC).

²Fuel consumption and CO₂ emissions figures are obtained under standardised test conditions (Directive 93/116/EEC) using a representative model. This allows direct comparison between different models from different manufacturers, but may not represent the actual fuel consumption achieved in 'real world' driving conditions. More information is available at www.vca.gov.uk

³Vehicle's unladen weight without driver (calculated in accordance with the current version of Directive 80/1268/EEC). The fitting of additional equipment may increase the vehicle's unladen weight and drag coefficient, whereupon the potential carrying capacity and top speed will be correspondingly reduced.

⁴The engine's power output always goes down with increasing altitude. At 1,000m above sea level, and for every additional 1,000m, deduct 10% from the weight of the outfit (trailer load limit + gross weight of the towing vehicle).

Please note: The maximum power output figures are quoted in PS (or Pferdestärke, which is the metric equivalent of brake horsepower). To convert to brake horsepower, divide the PS figure by 1.0139.



A7 Sportback dimensions

The technical drawings opposite show the exact dimensions of the Audi A7 Sportback, so you can check everything – from whether the car will fit in your garage to whether your luggage will fit in the boot.

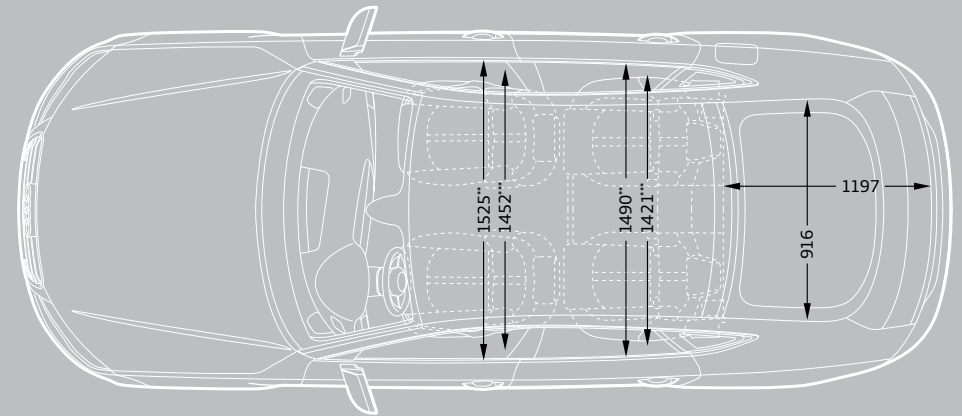
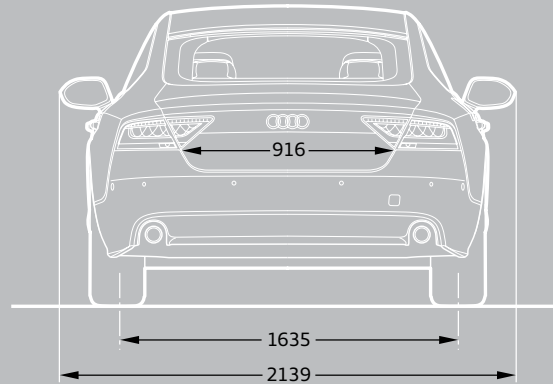
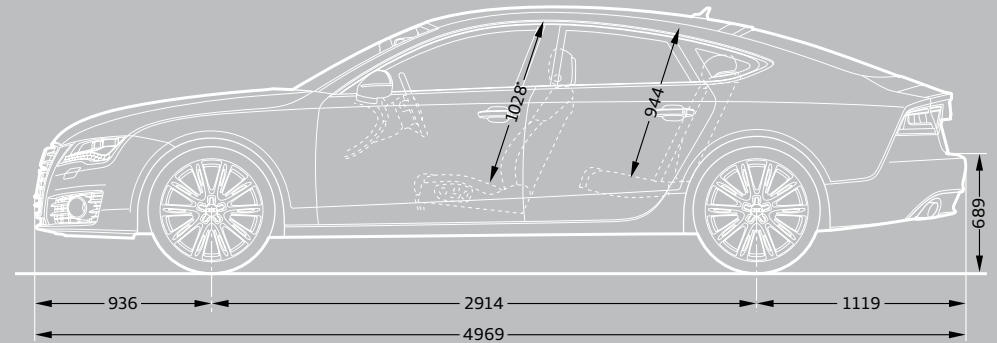
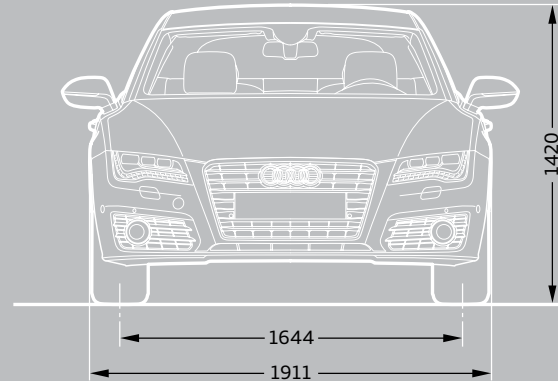

*Maximum headroom.

**Elbow room width.

***Shoulder room width.

Dimensions in millimetres.

Turning circle approx 11.9m.

Dimensions were measured with vehicle at unladen weight. Luggage compartment volume in litres: 535/1390 (measured by the VDA standard test method using 200 x 100 x 50mm blocks; second value: with rear seat folded down).

S7 Sportback dimensions

The technical drawings opposite show the exact dimensions of the Audi S7 Sportback, so you can check everything – from whether the car will fit in your garage to whether your luggage will fit in the boot.

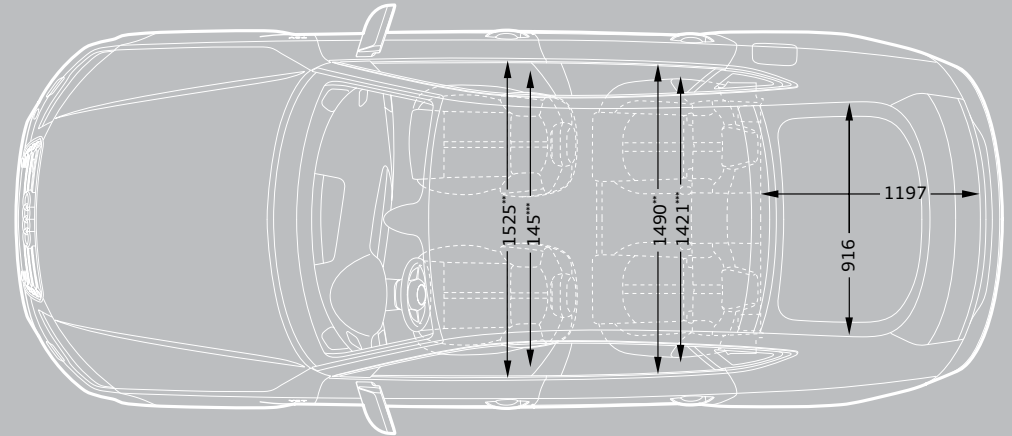
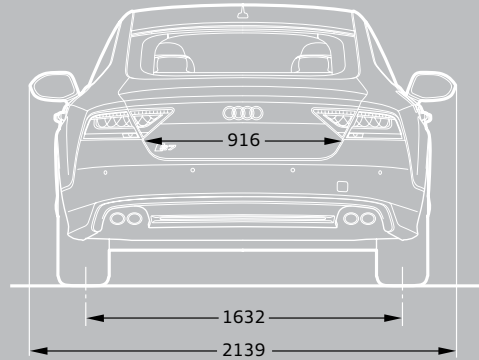
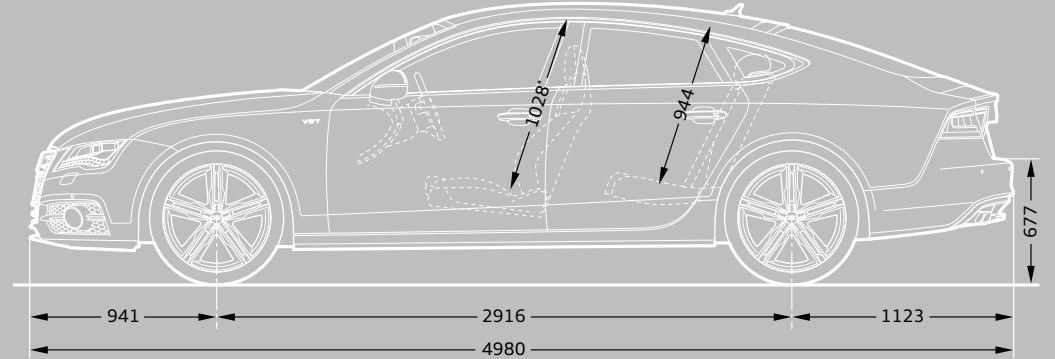
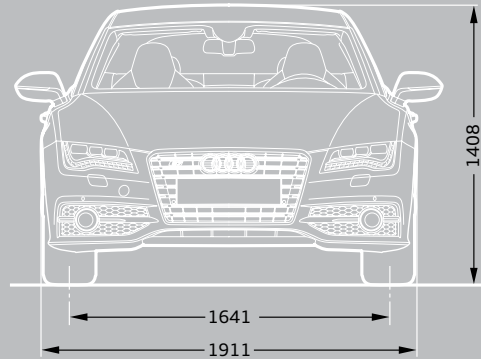

*Maximum headroom.

**Elbow room width.

***Shoulder room width.

Dimensions in millimetres.

Turning circle approx 11.9m.

Dimensions were measured with vehicle at unladen weight. Luggage compartment volume in litres: 535/1390 (measured by the VDA standard test method using 200 x 100 x 50mm blocks; second value: with rear seat folded down).

Pricing and Additional information

Welcome to Audi

By placing an order for your Audi, you're choosing to get behind the wheel of one of the most sophisticated cars on the road. And because we believe the service we offer should be just as advanced, we want to let you know exactly what you can expect from us, now and in the future.

We've agreed a set of standards with all our Centres which governs the way we do business with you. It outlines the kind of service we promise to deliver for every customer, right down to filling each new Audi we sell with half a tank of fuel.

So whether you're interested in the date your car will arrive in the UK or the way we'll dispose of non-biodegradable materials after we service your Audi, you can have total confidence in us.

Audi Promise

Audi Centres

We guarantee that all our Centres will be open as follows:

Sales: Monday to Friday 9am–6pm
Saturday 9am–5pm

Service: Monday to Friday 8am–6pm
Saturday 8.30am–1pm

Sunday opening is at local discretion.

New car delivery

Once we've confirmed a delivery date for your car, we'll keep you informed of progress. Subject to reasonable notice, we'll then deliver it to a place of your choice, whether that's your home or work. In the unlikely event of a delay, we'll provide a courtesy car to minimise inconvenience and keep you mobile.

Environmental commitment

We promise to dispose of all non-biodegradable materials from your vehicle in a responsible manner.

Pricing

Prices and specifications given are correct at the time of printing. Always check details with your Audi Centre as Audi policies are continually developing. We reserve the right to change prices or specifications at any time.

All prices are subject to VAT, currently charged at 20%, but this may alter to reflect any change in the applicable VAT rate.

Delivery charges and number plates are not included in the vehicle price.

Delivery charge	£471.66
Number plate	£20.00
VAT	£98.34
Total	£590.00

Audi Customer Care

Every new Audi benefits from the comprehensive Audi Customer Care Package, which comprises:

- ▶ A 3-year Audi warranty, which covers you for unlimited mileage in the first 2 years of ownership, with a full mechanical and electrical warranty which covers you for up to 60,000 miles in the 3rd year
- ▶ A 3-year paint warranty
- ▶ A 12-year anti-corrosion warranty
- ▶ 3 years' UK roadside assistance and recovery

You also have the option when ordering your new car of choosing a 4-year or 5-year Audi warranty. Speak to a member of the sales team for more information.

Audi tax-free sales

If you are entitled to purchase a vehicle free of VAT, normally through military or diplomatic privilege, please contact your local Audi Centre for full details.

Should you have any difficulty obtaining the information you require, please call 01908 548 356.

Audi Finance

Audi Finance specialises in providing funding solutions for Audi drivers. Whether your Audi is for private or business use, there is a range of funding options to choose from.

Below is the full range of finance products, which comprises:

- ▶ Solutions – a Personal Contract Plan
- ▶ Hire purchase
- ▶ Lease purchase
- ▶ Finance lease
- ▶ Contract hire

With all products, you can choose a fixed-cost maintenance plan designed to help you budget accurately.

No matter which Audi model you choose, your local Audi Centre can provide you with a personalised quote designed to fit your budget and motoring needs.

Audi Finance is a trading name of Volkswagen Financial Services (UK) Limited. An offer of finance depends on certain conditions. Available to people over 18 in the UK only.

Audi Insurance

We want you to start enjoying your new car from day one and thanks to Audi Insurance complimentary 7-day cover, you can. Call free on 0800 316 7893 (lines are open Monday to Friday 8am–9pm, and Saturday 9am–5pm), provide a few details and a cover note will be sent to your Audi Centre. They will then tax your car and you can drive it away.

Additional information

CO₂ data and information

CO₂ emissions-based Vehicle Excise Duty

Vehicle Excise Duty (Road Fund Licence) is based upon the amount of Carbon Dioxide (CO₂) a vehicle emits, measured in grams per kilometre (g/km). First year VED rates apply to the first year of ownership. Annual VED rates apply thereafter. The DVLA has created thirteen categories:

Petrol and Diesel engines	First year	Annual rate (second year onwards)
A – up to 100g/km	£0.00	£0.00
B – 101 to 110g/km	£0.00	£20.00
C – 111 to 120g/km	£0.00	£30.00
D – 121 to 130g/km	£0.00	£110.00
E – 131 to 140g/km	£130.00	£130.00
F – 141 to 150g/km	£145.00	£145.00
G – 151 to 165g/km	£180.00	£180.00
H – 166 to 175g/km	£290.00	£205.00
I – 176 to 185g/km	£345.00	£225.00
J – 186 to 200g/km	£485.00	£265.00
K – 201 to 225g/km	£635.00	£285.00
L – 226 to 255g/km	£860.00	£485.00
M – over 255g/km	£1,090.00	£500.00

Vehicle Excise Duty (VED) rates correct at time of going to print, but these may alter to reflect any change in the applicable VED rate





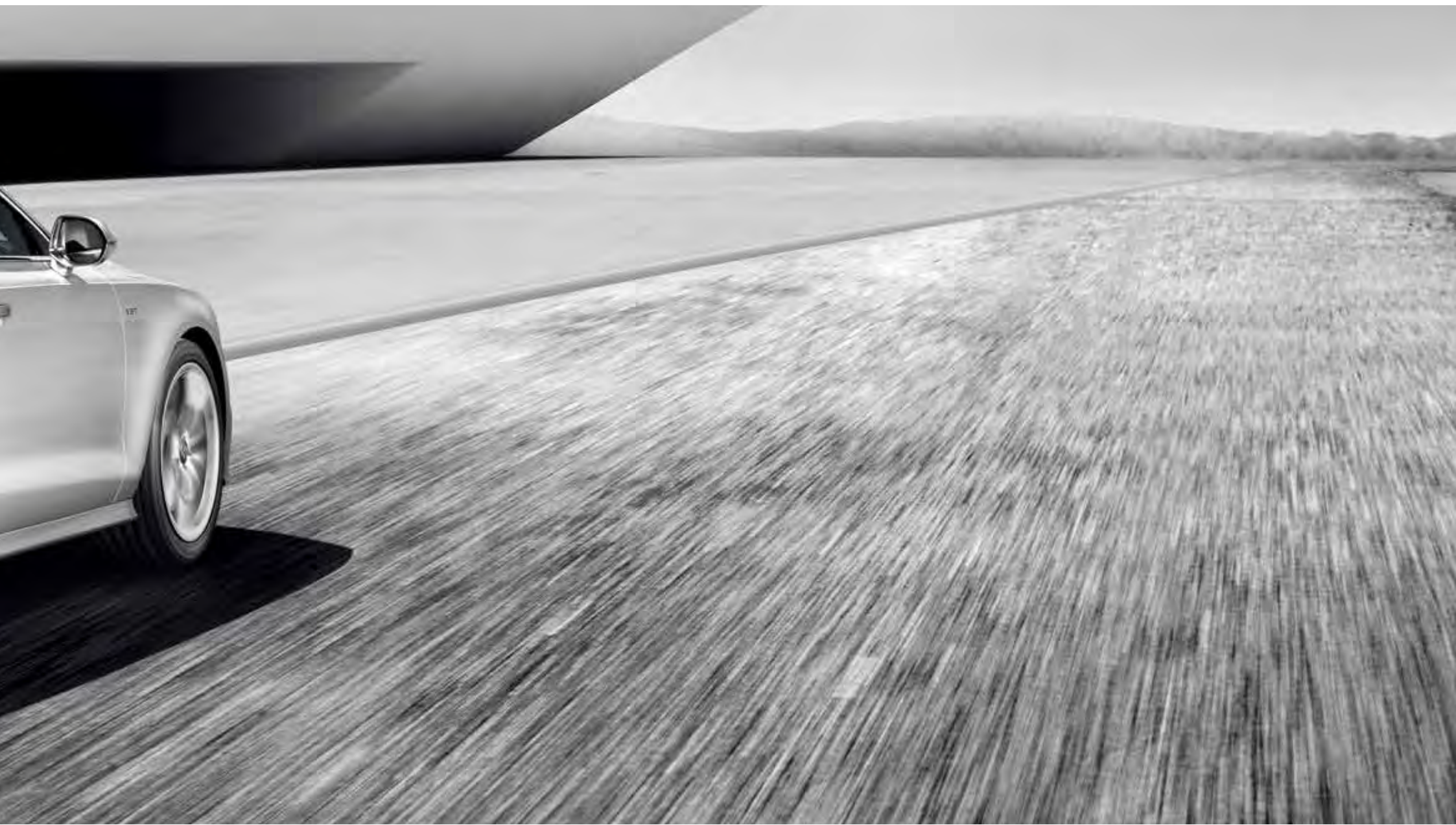

Audi UK

Customer Services
Selectapost 29
Sheffield
S97 3FG
0800 699888
audi.co.uk

Specifications and prices subject
to change without notice.

© Audi (UK)

Printed in the UK
Edition 3.1 06/14
2014 Model Year

Images are for illustrative purposes only.

