



The Audi Q7

Pricing and Specification Guide
Valid from April 2014

Personalising your Audi Q7

This guide has been designed to help you tailor and price your Audi Q7 quickly and logically. At the back, you will find information on CO2 emissions-based taxation and the other services offered by Audi, including Finance and Insurance. You can also configure your Audi Q7 online at audi.co.uk

Audi Vision

To accompany this printed guide, we've created Audi Vision – an intuitive app that lets you find out even more about the Audi Q7. Compatible with Apple and Android phones and tablets, Audi Vision gives you exclusive access to images, information and video content – all of which is designed to help you explore and understand the options available with this model.

You'll see the Audi Vision logo printed next to the page number on pages throughout this guide and wherever you do, you'll be able to view additional content on that page.



The Audi Q7

Engines	12
Transmission	13
Efficiency	14
quattro®	16

Model details and prices

SE model equipment	20
S line model equipment	22
S line Plus model equipment	24
S line Style Edition model equipment	26
S line Sport Edition model equipment	28
Model prices	30

Colour and upholstery

Paint	32
Upholstery	36
Seats	41
Colour and trim guide	42

Audi exclusive

44

Inlays

52

Options

Wheels and tyres	56
Packages	60
Audio and communication	62
Interior equipment	64
Exterior equipment	66
Safety and security	68
Steering wheels	69

Looking after your Audi

Audi Complete and Warranty	70
Accessories	73
Merchandise	74
Audi Difference	75

Technical details

Technical data	76
Dimensions	77
Pricing and Additional information	78





Vorsprung durch Technik

Three words that express the very essence of Audi. Vorsprung durch Technik isn't a slogan. It's our way of seeing the world. It is the driving force behind our history of innovation that continues into the 21st century. Indeed, many technologies that Audi pioneered remain in our cars today. Some are milestones in the history of the motorcar.

From our beginnings in 1899, to the Auto Union team's Grand Prix successes in the 1930s and our more recent wins at Le Mans, we have always been at the forefront of the motor industry.

Vorsprung durch Technik makes us who we are. To see more of its influence, just read on.









The Audi Q7 is available with our latest technology

The Audi Q7 is available with a choice of powerful engines, all of which use advanced fuel-injection technology. Features include adaptive air suspension, rear acoustic parking, rear LED lights and an optional HDD-based navigation system, as well as one other trademark Audi innovation: road-holding quattro® permanent all-wheel-drive, which keeps the car balanced in all conditions, across any terrain. Whichever model you choose, you'll also benefit from the practical 7-seat interior, which leaves enough room for the whole family.





Q7 interior story

We've introduced a number of finishing touches to the Audi Q7 interior to make your driving experience both comfortable and unique. You'll find an impressive attention to detail in everything from the luxurious leather seating to our optional customised stitching, which means that every journey you make will be a personal one.

Engines

Diesel

We introduced TDI® to the roads in 1989, and since then we've continuously refined it, including developing common-rail technology. Under this system, a series of piezo injectors uses electrical charge to precisely control the amount of fuel injected into the engine. As well as reducing noise, this allows combustion to happen at a lower temperature, with less oxygen, which lowers emissions.

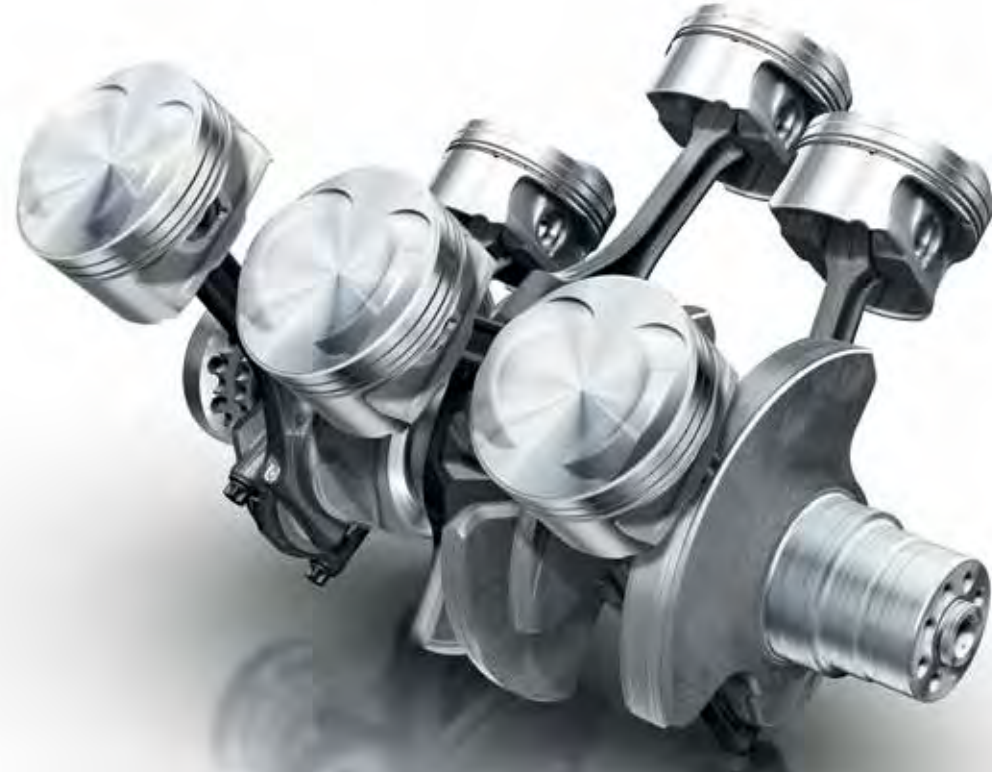



Transmission

8-speed tiptronic

The Audi Q7 comes with an advanced 8-speed tiptronic transmission system which reduces both fuel consumption and CO₂ emissions. It converts high-torque engine power into sporty performance and operating convenience, with crisp, fast gear changes and an optimised gear-shift strategy. More spontaneous gear changes are a particular benefit, especially when downshifting. Both in the 'D' (Drive) and 'S' (Sport) programme, the advanced electronics used in tiptronic respond efficiently to every driver input.

Efficiency

At Audi, doing less is something we're trying to do more of. We're working to use less fuel, release less CO₂ and waste less energy. It's why we've incorporated a number of more efficient technologies into the Audi Q7.

Recuperation

When a vehicle brakes, the discs convert the kinetic energy into thermal energy, which is wasted as it cannot be used. With a recuperation system like the one in the Audi Q7, the kinetic energy is converted into useful electrical energy. The way it works is simple. While the car is coasting or braking, the alternator voltage is raised above the level of the basic electrical system, which enables the alternator to generate electrical energy and store it temporarily in the battery. When the vehicle accelerates, this energy is used to relieve the load on the alternator, resulting in a fuel saving of up to 3%.





Aerodynamics

A car's shape can have a big impact on its efficiency. It's why we've worked to make the Audi Q7 as aerodynamic as possible, including technology such as adaptive air suspension that responds to changes in speed. It means that the Audi Q7 becomes more aerodynamic at high speeds while still offering good ground clearance in off-road situations.

Automatic Start-Stop function*

In heavy traffic, your car still uses fuel and releases CO₂, even when it's stationary. The automatic Start-Stop function counteracts this problem by switching off the engine when your car comes to a standstill. As soon as you release the brake pedal, the car restarts.

*Only available on 3.0 TDI engines.

quattro®

It's the technology that gave us the edge on the rally circuit from the moment it was first introduced over 30 years ago, bringing victory for the Audi quattro on its very first outing. It's called quattro® permanent all-wheel-drive. In this system, four permanently driven wheels deliver better acceleration, road-holding and safety, while asymmetric-dynamic torque distribution intelligently controls the flow of power to the front and rear axles.

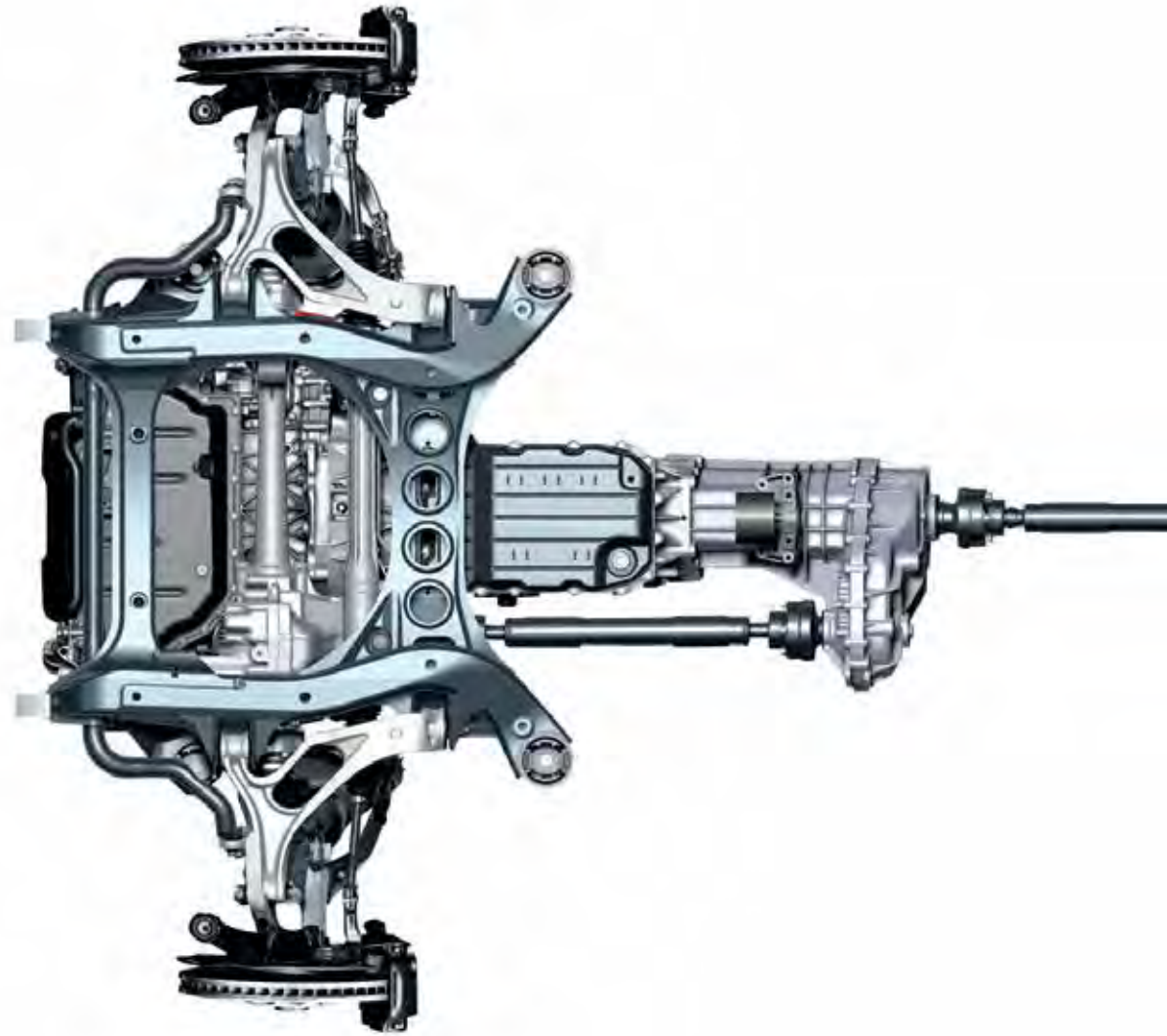

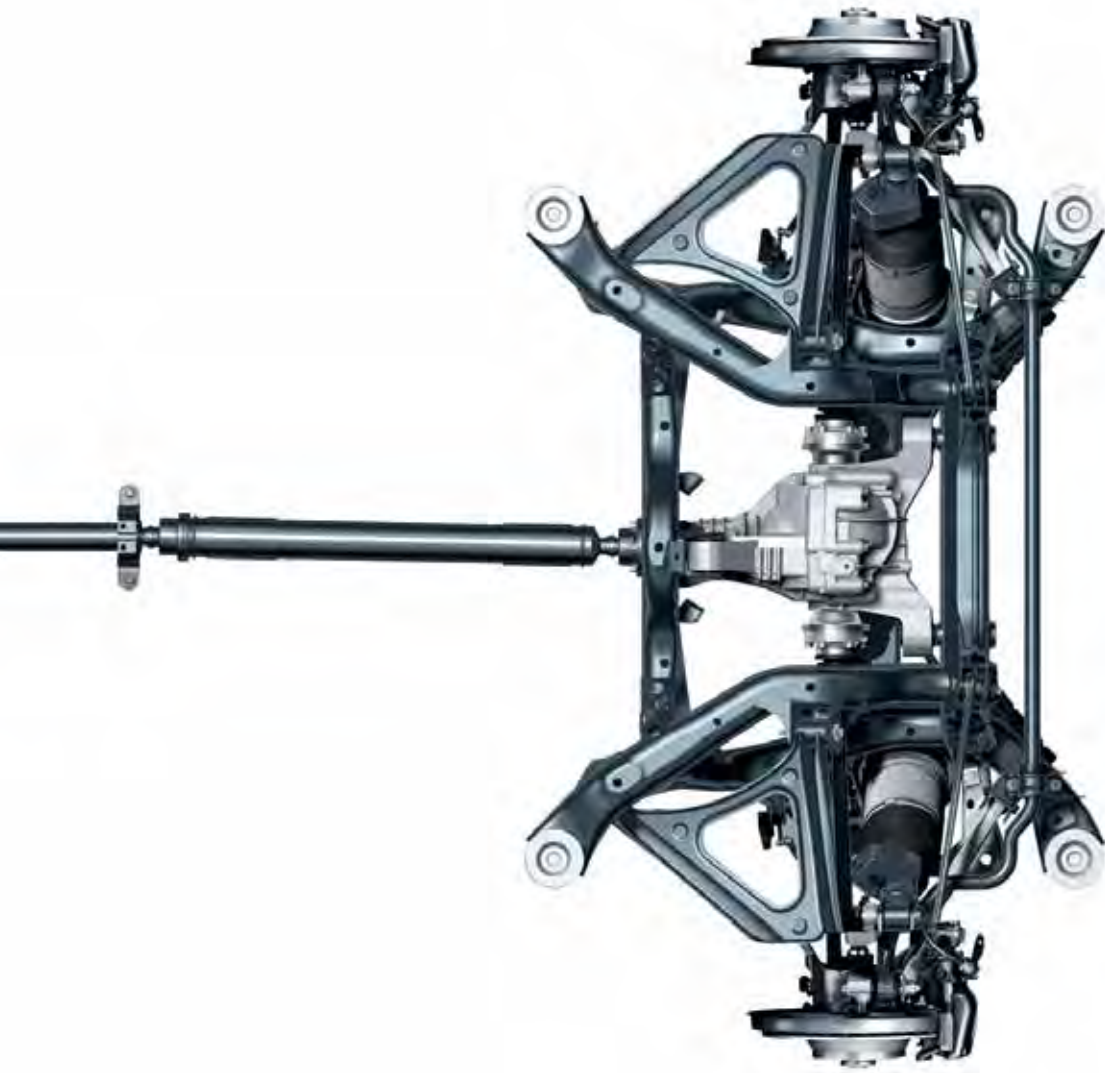

It means that the Audi Q7 can 'read' the road, sensing changes in the surface beneath the wheels and adjusting their grip accordingly. So when conditions get a little more demanding – in particular, when you go off-road – quattro® adapts, putting all the force of the Audi Q7's engine precisely where it's needed to handle the change in terrain.





SE model equipment

All Q7 SE models have the following items of standard equipment

Engine and transmission

Start-Stop system with energy recuperation (3.0 TDI engines only)

Wheels, tyres and suspension

19" x 8.5J '5-arm V' design alloy wheels with 265/50 R19 110Y tyres

Collapsible spare wheel with compressor – maximum speed 50mph (not on 4.2 TDI models)

Tyre Repair Kit (4.2 TDI models only)

Adaptive air suspension – electronically controlled air suspension with continuously adaptive damping system for all four wheels which regulates ride height and damping automatically. Choice of 5 modes (automatic, comfort, dynamic, off-road and lift) selected via the MMI system

Locking wheel bolts

Tool kit and car jack

Parking brake – foot-operated

Servotronic steering – power-steering with speed-dependent control

Safety and security

Driver's Information System (DIS) – monochrome display in the direct field of view of the driver. The DIS displays information from the on-board computer and digital speed display. The integrated efficiency programme provides consumption data overviews and fuel-saving tips

Cruise control – maintains any speed above 19mph, provided the engine power output and engine braking effect permit it; operated via separate steering column stalk. The set speed is displayed in the Driver's Information System display

Light and rain sensor – automatically switches the dipped beam or windscreen wipers on/off depending on the light and rain conditions. Includes coming home/leaving home function, automatic switching-on/delayed switching-off of the front fog lights, and number plate lighting when parking/opening the vehicle

Rear parking system – acoustically indicates how far away the vehicle is from an obstacle at the rear; measurement is by ultrasonic sensors integrated discreetly in the bumpers

Tyre pressure loss indicator – visual and acoustic warning if the pressure drops in one or more tyres

Double glazing – windscreen and side windows in 2-layer laminated safety glass, connected to each other by a plastic film. Improves insulation against outside noise and adds break-in protection

Side airbags for driver and front passenger

Side-impact protection in the doors

Sideguard head airbag system over the entire length of the side windows to protect front and outer rear passengers in the event of a side impact

Anti-theft alarm – Thatcham Category 1 approved

Anti-lock Braking System (ABS) and Electronic Brake-force Distribution (EBD)

Electronic Stability Control (ESC) with extended on- and off-road functions, and Trailer Stabilisation system

Electronic Differential Lock (EDL)

First-aid kit with warning triangle

Seats

7 seats (3 rows of seats) – second and third row can be split and folded flat to form a level load area

Standard seats in Cricket leather upholstery including seat covers, head restraints, front and rear centre armrests. Door panel in Alcantara



19" x 8.5J '5-arm V' design alloy wheels



Cricket leather upholstery



Aluminium window trim



Comfort front centre armrest

Front seats, electrically adjustable with adjustment for forwards/backwards position, seat height, seat and backrest angle, and electric lumbar support

Seat heating for front seats

ISOFIX child seat mounting – for front passenger (with airbag deactivation) and outer rear seats of the second and third row. Including Top Tether attachment point for outer rear seats of the second row

Audio and communication

MMI Radio Plus:

- 6.5" screen with colour display
- FM/AM radio
- DSP sound system
- 2 SDHC memory card readers (up to 32GB and a single CD player that supports MP3, WMA and AAC)
- TP memo – automatically saves traffic news when driving

DAB digital radio reception – integrated into MMI, receives digitally transmitted radio stations in addition to the range of analogue stations. Displays music track, artist and radio programme. Capable of DAB slideshow where transmitted. Also receives DAB+ and DMB audio signals. Reception dependent on local digital network. Automatic switch from DAB to FM reception if the network signal is not strong enough

Mobile telephone preparation – Bluetooth interface – Bluetooth-compatible mobile phones can be connected to the vehicle via the interface, allowing hands-free calls via the microphone. Please contact your Audi Centre for phone compatibility

Interior equipment

Dual-zone electronic climate control – automatic air conditioning which electronically regulates the air temperature, air-flow rate and distribution for the driver and front passenger sides

4-spoke leather multi-function steering wheel

Auto-dimming rear-view mirror – uses a photocell to recognise when the headlights behind are too bright and dims automatically

Comfort front centre armrest – for driver and front passenger, with fold-open storage compartment for the driver's side, a cup holder at the front on the passenger side as well as an additional cup holder in the armrest on the passenger side

Rear centre armrest in rear-seat backrest, folding, with 2 cup holders

Cup holders – 2 in side trim of third seating row

Inlays in Aluminium Trigon

Aluminium-look air vent surrounds

Illuminated vanity mirrors

Lighting package – includes door lighting under the exterior door mirrors, ambient LED lighting of the centre console, active door reflectors in the front and rear doors, footwell LED lighting at front and rear, rear door exit lights, lighting for air vents in the B-pillar and ashtray in the rear

Floor mats – front and rear

12V sockets – 1 at front of centre console, 2 at rear of centre console and 1 in luggage compartment

Cargo nets on backs of front seats

Sticker plates with metal inlays

Double load-floor with storage compartment and dirt-resistant tray

Luggage compartment cover

Luggage and storage net in luggage compartment

Through-load hatch in the rear-seat backrest

Exterior equipment

Contrasting bumpers – front and rear bumpers and side sills painted (bumper colour is dependent on paint colour – see page 43 for more information)

Door mirrors – electrically adjustable, heated and folding

Halogen headlights including fog lights incorporated into the front bumper apron

Rear LED lights

Aluminium roof rails

Aluminium window trim framing the exterior side windows



Image shows the Q7 SE model with optional Ice silver, metallic paint (P5)

S line model equipment

In addition to SE model equipment

Basic RRP
£1,383.33

Total RRP inc VAT
£1,660.00

Wheels, tyres and suspension

20" x 9J '5-spoke' design alloy wheels with 275/45 R20 107Y tyres

Seats

Front Sports seats, electrically adjustable with adjustment for forwards/backwards position, seat height, seat and backrest angle, and electric lumbar support

Pearl Nappa leather/Alcantara upholstery

Interior equipment

3-spoke, multi-function, leather steering wheel with gear-shift paddles

Black headlining

Inlays in matt-brushed aluminium

S line scuff plates

Exterior equipment

Headlight washers

S line badge on side wings

S line body styling, fully body coloured

Xenon Plus headlights with LED daytime-running lights and LED indicators



20" x 9J '5-spoke' design alloy wheels



Xenon Plus headlights with LED daytime-running lights



Front Sports seats in Pearl Nappa leather/Alcantara



3-spoke, multi-function, leather steering wheel



Image shows the Q7 S line model with optional Ice silver, metallic paint (P5) and stainless steel running boards (YNB)

S line Plus model equipment

In addition to S line model equipment

Basic RRP
£3,750.00

Total RRP inc VAT
£4,500.00

Wheels, tyres and suspension

21" x 10J '5-segment spoke' design alloy wheels with 295/35 R21 tyres

Seats

Verano leather upholstery

Exterior equipment

Privacy glass – dark tinted glass from B-pillar backwards

Running boards

Metallic or pearl-effect paint – a choice of 12 colours

Power-operated tailgate – opens by pressing button on the car key, button in the driver's door trim or soft-touch button in the handle recess on the luggage compartment lid. Includes lid-closing assistance unit and programmable angle for the luggage compartment lid

Audio and communication

Satellite Navigation system, HDD-based including MMI Radio Plus – route planning and guidance using voice, pictogram and 3D mapping. Includes AM/FM tuner with TP memo function. Single front-loading CD/DVD player with MP3 compatibility, suitable for audio and DVD playback. Third generation MMI system including high-resolution (800x400) 7" colour TFT display, two SD card readers and 40GB hard drive, 10GB of which can be used to store up to 4,000 songs. HDD navigation functionality includes advanced speech recognition, 7-digit postcode functionality, 3D and topographical mapping display, and advanced 3D building display

Mobile telephone preparation, High with Audi connect – allows a Bluetooth-capable mobile phone to connect to the vehicle's internal UMTS module (providing the mobile phone has a SIM Access Profile*). This allows the navigation to use Google Earth images and Audi traffic information online. Please see page 60 for more details

Colour Driver's Information System (DIS) with efficiency programme

Audi parking system advanced – aids parking by acoustically and visually indicating distances to obstacles with guiding lines measured by sensors and reversing camera

Audi Music Interface – universal connection for use with stereo audio sources, USB and MP3 devices including Apple iPod generation 4 onwards (iPod, iPod classic, iPod mini, iPod nano, iPod photo, iPod video, iPod touch). Provides intuitive control through the audio system and multi-function steering wheel. It also replicates the iPod display on the audio screen and DIS, including track titles. The interface provides charging function (dependent on device). Includes 2 cables to connect your iPod or USB MP3 player

When ordered with a sunroof (3FU/3FV) and electric trailer towing hitch (1D9), deletion of third seating row (5KM) must be added.

*Online services are only available for mobile phone contracts including a data option and only within the coverage of the mobile phone network; there may be additional costs for the use of these services (charges and billing correspond to the personal mobile phone contract). Due to high data volumes, a mobile phone contract including an unlimited data plan is strongly recommended. The content and scope of online-based services offered may vary.



21" x 10J '5-segment spoke' design alloy wheels



Running boards



Privacy glass

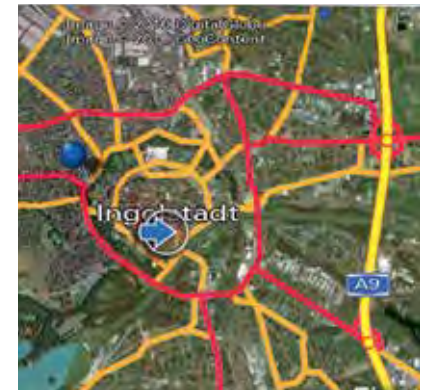

Satellite Navigation system – HDD-based



S line Style Edition model equipment

In addition to S line Plus
model equipment

Basic RRP
£1,250.00

Total RRP inc VAT
£1,500.00

Wheels, tyres and suspension

21" x 9J '5-arm rotor' design alloy wheels
in matt titanium finish with 275/40 R21
107Y tyres

Exterior equipment

Off-road style package in body colour including

- underbody guard in stainless steel finish
- chrome inserts in door handles
- extended wheel arches and front and rear bumper in body colour
- door trim-strips in body colour

Only available in the following colours

- Night black, solid
- Teak brown, metallic
- Lava grey, pearl effect
- Orca black, metallic
- Graphite grey, metallic
- Daytona grey, pearl effect
- Scuba blue, metallic



21" x 9J '5-arm rotor' design alloy wheels in matt titanium finish



Door trim strips in body colour and running boards



Underbody guard in stainless steel finish



S line Sport Edition model equipment

In addition to S line Plus
model equipment

Basic RRP
£2,500.00

Total RRP inc VAT
£3,000.00

Wheels, tyres and suspension

21" x 10J '5-segment-spoke' design alloy wheels in titanium finish with 295/35 R21 107Y tyres

Exterior equipment

Exterior sports styling package including

- front lower bumper spoilers
- stainless steel underbody protection
- large side air intakes with high-gloss black painted horizontal side bars
- extended wheelarches and door trims
- dual oval shaped tailpipes integrated in the rear bumper
- door lower protection strips

Please note that the exterior sports styling package removes front fog lights



21" x 10J '5-segment spoke' design alloy wheels in titanium finish



Large side air intakes with high-gloss black painted horizontal side bars



Dual oval shaped tailpipes integrated in the rear bumper



Audi Q7 SE

Engines	Power	Transmission	CO2 g/km	Basic RRP	Total RRP inc VAT	Recommended OTR
3.0 TDI quattro	204PS	8-speed tiptronic	189	£35,637.50	£42,765.00	£43,895.00

Audi Q7 S line

Engines	Power	Transmissions	CO2 g/km	Basic RRP	Total RRP inc VAT	Recommended OTR
3.0 TDI quattro	204PS	8-speed tiptronic	189	£37,020.83	£44,425.00	£45,555.00
3.0 TDI quattro	245PS	8-speed tiptronic	195	£38,212.50	£45,855.00	£46,985.00
4.2 TDI quattro	340PS	8-speed tiptronic	242	£45,929.17	£55,115.00	£56,620.00

Please note: The maximum power output figures are quoted in PS (or Pferdestärke, which is the metric equivalent of brake horsepower). To convert to brake horsepower, divide the PS figure by 1.0139.

Recommended On-The-Road (OTR) retail prices include: delivery charge, half a tank of fuel, number plates at £590.00 (inc. VAT), Road Fund Licence (which may vary depending on model/transmission – see page 79 for details) and first registration fee at £55.00. Vehicle Excise Duty correct at time of going to print, but this may alter to reflect any change in the applicable VED rate.

RRP – Recommended Retail Price. VAT is calculated at 20% but this may alter to reflect any change in the applicable VAT rate.

Audi Q7 S line Plus

Engines	Power	Transmissions	CO2 g/km	Basic RRP	Total RRP inc VAT	Recommended OTR
3.0 TDI quattro	204PS	8-speed tiptronic	189	£40,770.83	£48,925.00	£50,055.00
3.0 TDI quattro	245PS	8-speed tiptronic	195	£41,962.50	£50,355.00	£51,485.00
4.2 TDI quattro	340PS	8-speed tiptronic	242	£49,679.17	£59,615.00	£61,120.00

Audi Q7 S line Style Edition

Engines	Power	Transmissions	CO2 g/km	Basic RRP	Total RRP inc VAT	Recommended OTR
3.0 TDI quattro	245PS	8-speed tiptronic	195	£43,212.50	£51,855.00	£52,985.00
4.2 TDI quattro	340PS	8-speed tiptronic	242	£50,929.17	£61,115.00	£62,620.00

Audi Q7 S line Sport Edition

Engines	Power	Transmissions	CO2 g/km	Basic RRP	Total RRP inc VAT	Recommended OTR
3.0 TDI quattro	245PS	8-speed tiptronic	195	£44,462.50	£53,355.00	£54,485.00
4.2 TDI quattro	340PS	8-speed tiptronic	242	£52,179.17	£62,615.00	£64,120.00



Paint

We believe that every part of your car should have a personal touch. Which is why you can choose from a wide range of paint colours and finishes, from standard shades to metallic and pearl effects. We can even mix a customised colour for you to create the perfect fit.

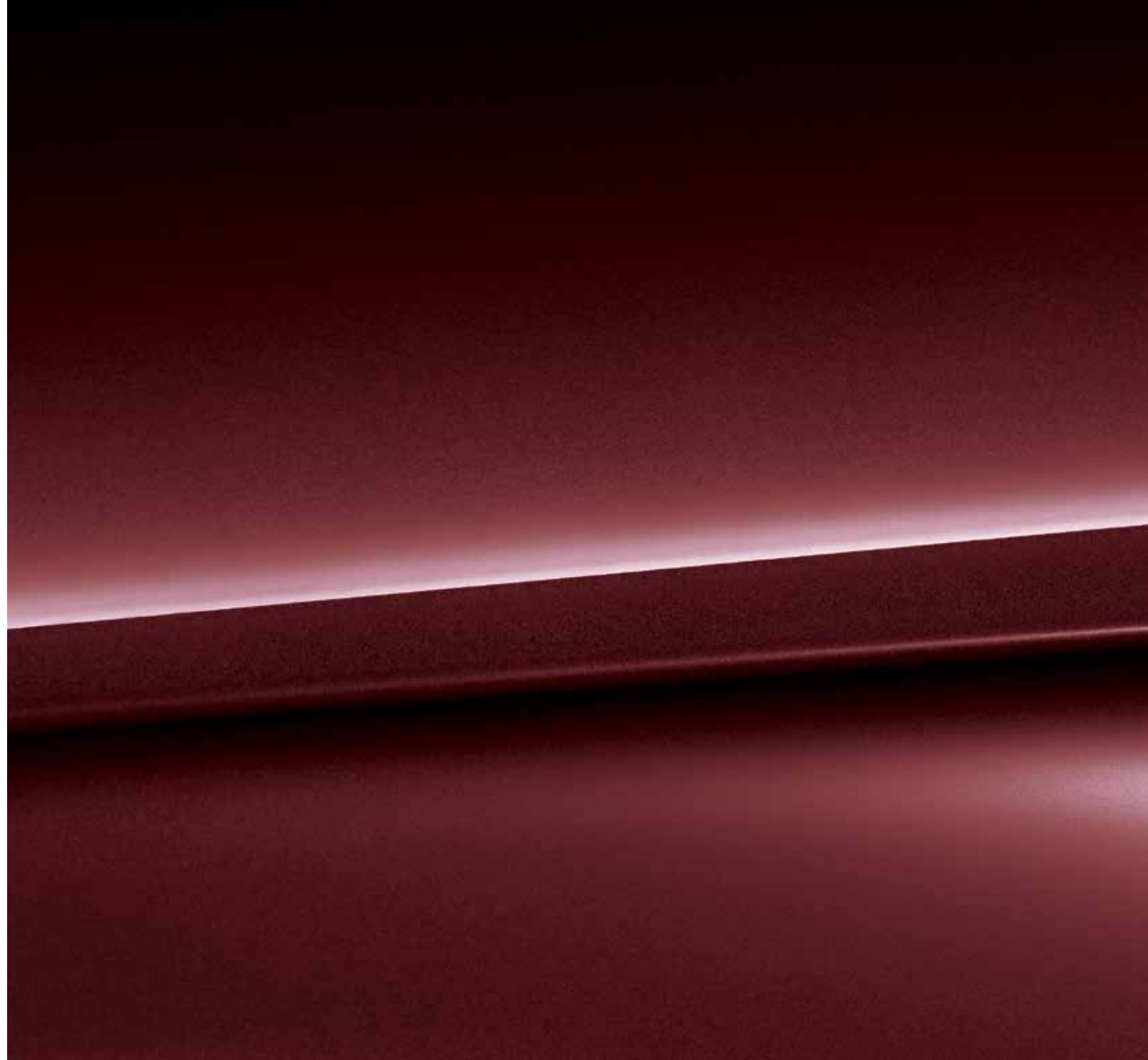

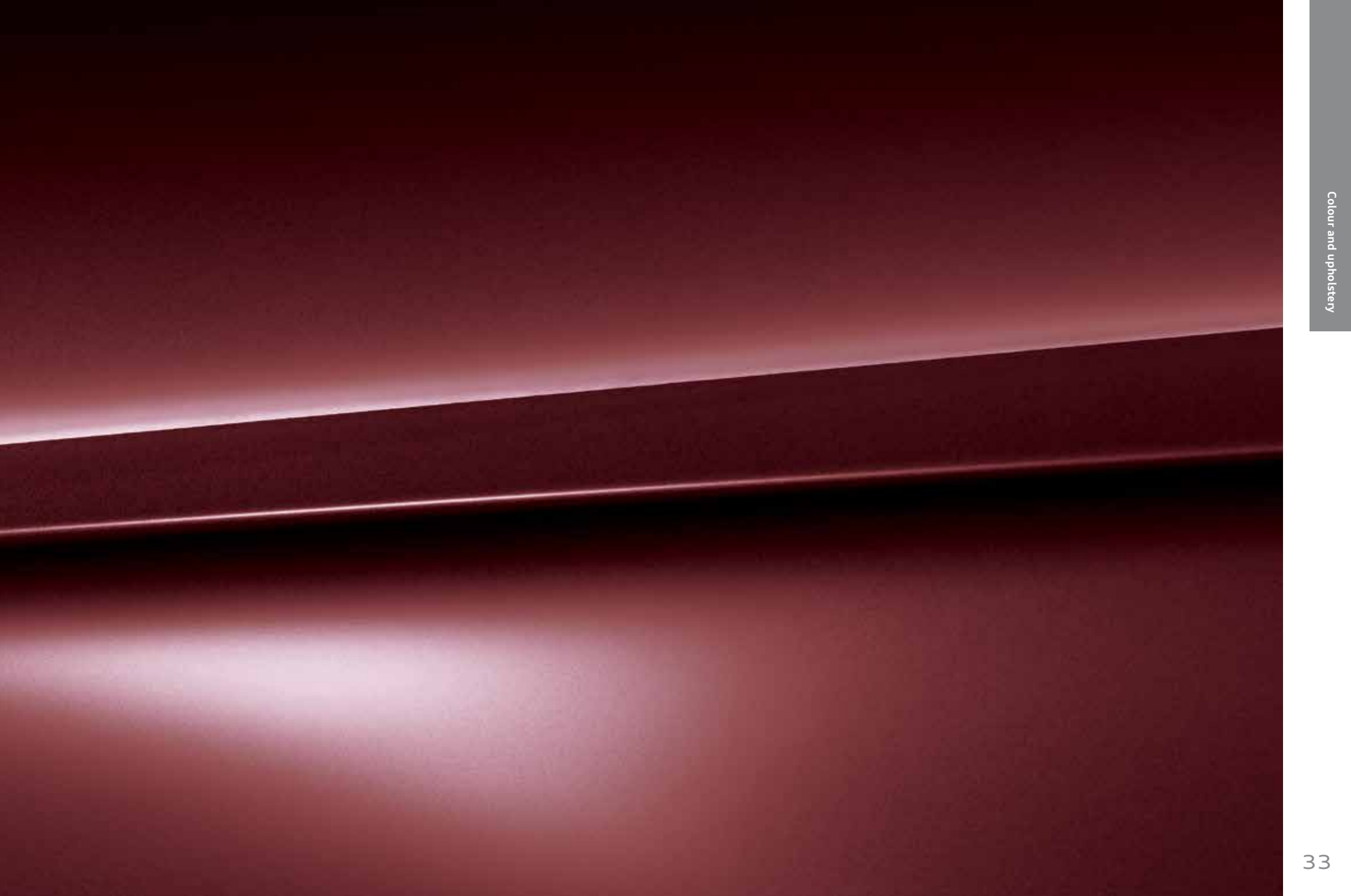

Paint

You can select one of the standard colours shown opposite or, for a different look, choose from a range of optional finishes.

Options are subject to availability and may extend delivery.

All the colour swatches on this page are matched as accurately as possible to the actual paint colours used. However, due to print processes, Audi UK cannot guarantee that colours shown are 100% accurate.

Visit your local Audi Centre for a more accurate colour swatch.

*Not available on S line Style Edition.

RRP – Recommended Retail Price.

VAT is calculated at 20% but this may alter to reflect any change in the applicable VAT rate.

Standard colours



Pure white – 0Q*

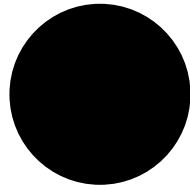

Night black – A1

Optional colours

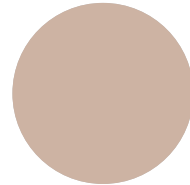

Bahia beige, metallic – 6L*

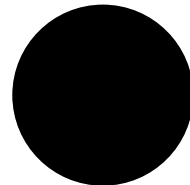

Orca black, metallic – 2T

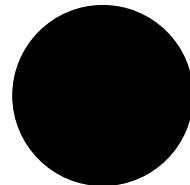

Lava grey, pearl effect – 1R

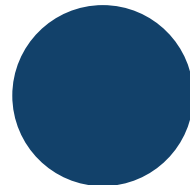

Scuba blue, metallic – S9

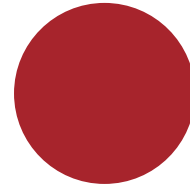

Garnet red, pearl effect – 9C*

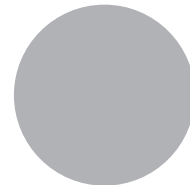

Ice silver, metallic – P5*

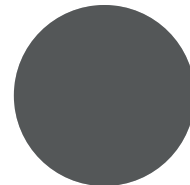

Graphite grey, metallic – 9Q



Glacier white, metallic – 2Y*

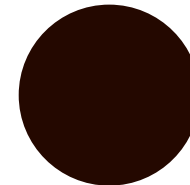

Teak brown, metallic – 4U

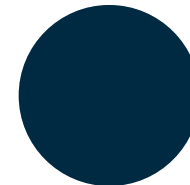

Atlantis blue, metallic – Z2*

S line colours

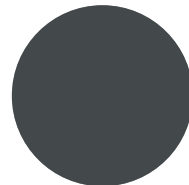

Daytona grey, pearl effect – 6Y

Optional and S line colours

Basic RRP

£545.83

Total RRP inc VAT

£655.00

No charge on S line Plus, S line Style Edition and S line Sport Edition models

Paint

Audi exclusive

Everyone has a favourite colour. No matter what yours is, Audi exclusive provides a range of unique colours that have been designed to set your car apart. Choose from the swatches here, or specify any other paint colour in the Audi range – whether it's Sepang blue from the Audi R8 or Alpine white from the original Audi quattro. The choice is yours.**

Customised

If you have a particular colour in mind, we'll mix the exact metallic or pearl-effect shade you want.***

*Not available on the S line Style Edition.

*Audi exclusive paint is subject to factory approval. Visit your local Audi Centre for colour samples.

**Customised paint is subject to factory approval, and is available for metallic and pearl-effect water-based paints only. Three-colour process colours and two-tone schemes are not available.

All the colour swatches on this page are matched as accurately as possible to the actual paint colours used. However, due to print processes, Audi UK cannot guarantee that colours shown are 100% accurate.

Visit your local Audi Centre for a more accurate colour swatch.

RRP – Recommended Retail Price.

VAT is calculated at 20% but this may alter to reflect any change in the applicable VAT rate.

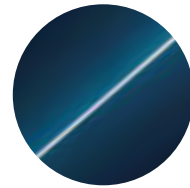

Palace blue, pearl effect

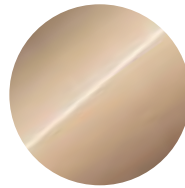

Sand beige, pearl effect

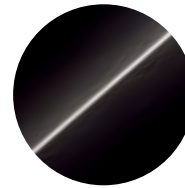

Saddle brown, pearl effect

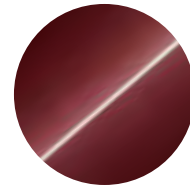

Classic red, pearl effect

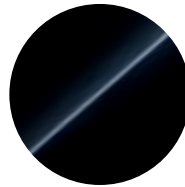

Mamba black, metallic

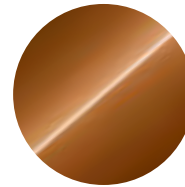

Ipanema brown, metallic



Any colour in the Audi range or 100 exclusive colours to choose from**



Customised paint***

Audi exclusive†*

Basic RRP
£1,795.83

Total RRP inc VAT
£2,155.00

Customised†**

Basic RRP
£2,212.50

Total RRP inc VAT
£2,655.00

Upholstery

It's important to feel comfortable on the road. Just choose from our range of luxury upholstery materials and textures, including additional support and colour options, for complete relaxation while you drive.





Upholstery

Standard seats

Choose your favourite upholstery from the swatches shown opposite to give your car's interior the look and feel you want.

Cricket leather – PEB

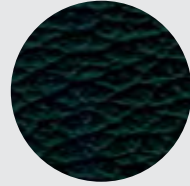

Black – CA/FP

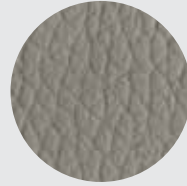

Light grey – CF/CG



Paranut brown – FR /FQ



Savanna beige – FT/FS



Cardamom beige – FV/FU

Verano leather – PEC

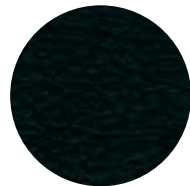

Black – CA/FP

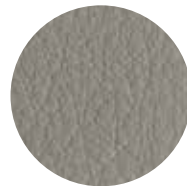

Light grey – CF/CG

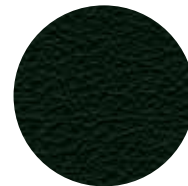

Paranut brown – FR/FQ

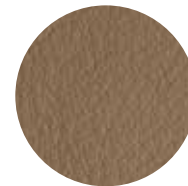

Savanna beige – FT/FS

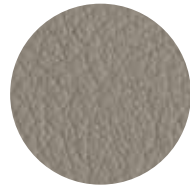

Cardamom beige – FV/FU

SE	S line	S line Plus	S line Style Edition	S line Sport Edition	Basic RRP	Total RRP inc VAT
S	-	-	-	-	No charge	No charge
•	-	-	-	-	£679.17	£815.00

Options are subject to availability and may extend delivery.

- = Not available
- = Available
- S = Standard

RRP – Recommended Retail Price.

VAT is calculated at 20% but this may alter to reflect any change in the applicable VAT rate.

Upholstery

Sports seats

Front seats are electrically adjustable.

Pearl Nappa
leather/Alcantara
– PED



Black – CA/FP



Light grey – CF/CG

Verano leather
– PEE

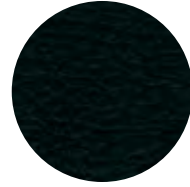

Black – CA/FP

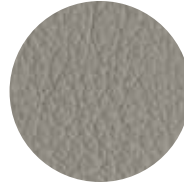

Light grey – CF/CG

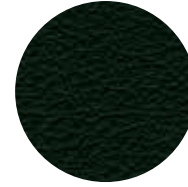

Paranut brown – FR/FQ

SE	S line	S line Plus	S line Style Edition	S line Sport Edition	Basic RRP	Total RRP inc VAT
●	–	–	–	–	£554.17	£665.00
●	–	–	–	–	£1,704.17	£2,045.00



Options are subject to availability and may extend delivery.

- = Not available
- = Available
- S = Standard

RRP – Recommended Retail Price.

VAT is calculated at 20% but this may alter to reflect any change in the applicable VAT rate.

Upholstery

S line Sports seats

Sports seats including electrically adjustable lumbar support.

Leather/Alcantara
– N7K



Black – QE



Black with silver stitching – QF

Verano leather
– N1W

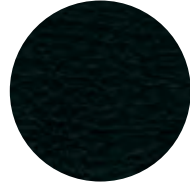

Black – QE

SE	S line	S line Plus	S line Style Edition	S line Sport Edition	Basic RRP	Total RRP inc VAT
–	S	–	–	–	No charge	No charge
–	•	–	–	–	£1,150.00	£1,380.00
–	–	S	S	S	No charge	No charge

Options are subject to availability and may extend delivery.

- = Not available
- = Available
- S = Standard

RRP – Recommended Retail Price.

VAT is calculated at 20% but this may alter to reflect any change in the applicable VAT rate.

Seats

Choose from a variety of different seat options so you can maintain the correct driving posture at all times.

Order Code		SE	S line	S line Plus	S line Style Edition	S line Sport Edition	Basic RRP	Total RRP inc VAT
4A4	Heated front and outer rear seats for the second row. Individually controlled with variable temperature adjustment	●	●	●	●	●	£116.67	£140.00
PV6 6XL	Electrically adjustable front seats with driver and front passenger seat memory. Includes adjustment for height, forwards and backwards position, backrest angle and lumbar support, as well as memory for electrically adjusted steering column, if fitted. Also includes electrically folding, heated, auto-dimming door mirrors with memory	●	●	●	●	●	£512.50	£615.00
5KM	Deletion of third seating row	●	●	●	●	●	No charge	No charge
3X2	Through-load facility. Includes removable ski bag for transporting long objects	●	●	●	●	●	£129.17	£155.00



7-seat configuration

Options are subject to availability and may extend delivery.

- = Not available
- = Available
- S = Standard

RRP – Recommended Retail Price.

VAT is calculated at 20% but this may alter to reflect any change in the applicable VAT rate.

Colour and trim guide

Interior trim colours

Standard seats

To help you choose the right interior for your Audi Q7, please use this guide, showing the carpet, dashboard and headlining colours that have been matched to your chosen upholstery.

Order Code	Upholstery	Carpet	Dashboard (upper/lower)	Headlining	Cricket leather (PEB)	Verano leather (PEC)
CA	Black	Black Velour	Black/Black	Light grey	●	●
CF	Light grey	Grey Velour	Black/Grey	Light grey	●	●
FR	Paranut brown	Black Velour	Black/Black	Light grey	●	●
FT	Savanna beige	Black Velour	Black/Black	Linen beige	●	●
FV	Cardamom beige	Tara beige Velour	Pimento beige/Tara beige	Linen beige	●	●
FP	Black	Black/Multicolour Fresco	Black/Black	Light grey	●	●
CG	Light grey	Grey-beige/Multicolour Fresco	Black/Grey	Light grey	●	●
FQ	Paranut brown	Black/Multicolour Fresco	Black/Black	Light grey	●	●
FS	Savanna beige	Black/Multicolour Fresco	Black/Black	Linen beige	●	●
FU	Cardamom beige	Grey-beige/Multicolour Fresco	Pimento beige/Tara beige	Linen beige	●	●

Sports seats

Order Code	Upholstery	Carpet	Dashboard (upper/lower)	Headlining	Verano leather (PEE)	Pearl Nappa leather/Alcantara (PED)
CA	Black	Black Velour	Black/Black	Light grey	●	●
CF	Light grey	Grey Velour	Black/Grey	Light grey	●	●
FR	Paranut brown	Black Velour	Black/Black	Light grey	●	—
FP	Black	Black Velour	Black/Black	Light grey	●	●
CG	Light grey	Grey-beige/Multicolour Fresco	Black/Grey	Light grey	●	●
FQ	Paranut brown	Black/Multicolour Fresco	Black/Black	Light grey	●	—

S line Sports seats

Order Code	Upholstery	Carpet	Dashboard (upper/lower)	Headlining	Verano leather (N1W)	Pearl Nappa leather/Alcantara (N7K)
QE	Black	Black	Black/Black	Black	●	●
QF	Black with silver stitching	Black	Black/Black	Black	—	●

Options are subject to availability and may extend delivery.

- = Not available
- = Available
- S = Standard

Colour and trim guide

Exterior colour and bumper guide (SE models only)

Solid paint

Metallic paint

Pearl-effect paint

Order Code	Exterior colour	Soul black	Platinum grey
0Q	Pure white	●	—
A1	Night black	—	●

Order Code	Exterior colour	Soul black	Platinum grey
P5	Ice silver	●	—
9Q	Graphite grey	●	—
4U	Teak brown	●	—
2T	Orca black	—	●
2Y	Glacier white	—	●
Z2	Atlantis blue	—	●
6L	Bahia beige	●	—

Order Code	Exterior colour	Soul black	Platinum grey
1R	Lava grey	—	●
9C	Garnet red	—	●

Options are subject to availability and may extend delivery.

- = Not available
- = Available
- S = Standard

Audi exclusive

Audi exclusive enables you to create an Audi that's unique to you, with precisely the colours, finishes and interior detailing you want. You can customise as much or as little as you like, specify just one detail or design your car's overall appearance. It's entirely up to you.

Leather and stitching colours, inlays and carpets can all be tailored, and with hundreds of possible paint combinations we're sure to find the exterior colour you have in mind. We can even mix the exact metallic paint or pearlescent shade you want for your Audi.

Or, if you'd rather leave some of the decisions in the capable hands of our designers, that's possible too thanks to the Audi exclusive line – combining some of the most popular elements of the exclusive range in one, beautifully coordinated package.





Upholstery

Audi exclusive

With Audi exclusive, you can specify your seats and any other Audi exclusive options, in Fine Nappa leather or Fine Nappa/Alcantara, from an array of different colours shown here as well as black.

Select just one all-over shade for each seat, or customise each panel in two or more complementary colours from the distinctive Audi exclusive palette – all for the same price. You can even choose the colour of the decorative stitching – to match or contrast with your chosen upholstery – from this varied collection. Whatever combination you decide upon, we are sure you'll be more than satisfied with the result.

Also available:

Alcantara colours: available in all the Audi exclusive colours shown, except for Crimson red, Jet grey and Sand beige. Alcantara equivalents are Chilli red, Amethyst grey and Sesame beige respectively.

Dashboard: available in Havanna brown, Saddle brown, Chestnut brown, Cognac brown, Classic red, Crimson red, Jet grey, Night blue, Smoky blue and Iceland green.

Please consult your Audi Centre for examples of Alcantara and carpet colours.

Options are subject to availability and may extend delivery.

Audi exclusive colours

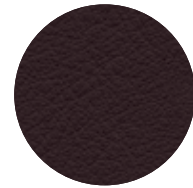

Chestnut brown



Jet grey



Alabaster white

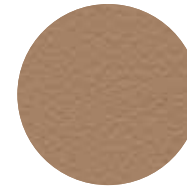

Sand beige

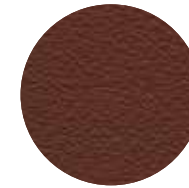

Saddle brown



Crimson red



Magnolia white



Havanna brown

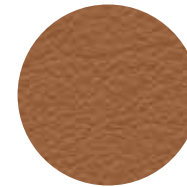

Cognac brown

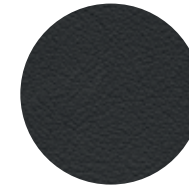

Night blue



Cloudy grey

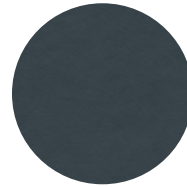

Smoky blue

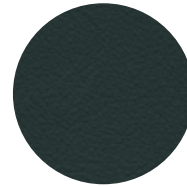

Iceland green

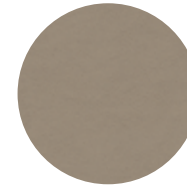

Powder beige

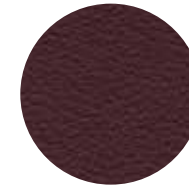

Classic red



Audi exclusive leather package in one all-over shade in Havanna brown, with black stitching



Audi exclusive leather package in two-tone design in Alabaster white and black, with Alabaster white stitching

Upholstery

Audi exclusive

Order Code		SE	S line	S line Plus	S line Style Edition	S line Sport Edition	Basic RRP	Total RRP inc VAT
PYA S3G	Audi exclusive leather package 1 in Fine Nappa leather* . Includes leather-covered seat upholstery and front centre armrest, velour carpets and floor mats and aluminium air-vent surrounds. Backrest covers and seat add-on parts come in the interior trim colour. Only available in combination with CA/CF interior trim	●	—	—	—	—	£2,783.33	£3,340.00
PYG S3G	Audi exclusive leather package 1 in Fine Nappa leather with Sports seats*** . Includes all the contents of leather package 1 (PYA/S3G) plus: leather-covered front Sports seats. Seat side trims and add-on parts come in the interior trim colour. Only available in combination with Carbon or Piano finish black inlays (STU/STL) on all models excluding SE	●	—	—	—	—	£3,808.33	£4,570.00
PYD S3G	Audi exclusive leather package 2 in Fine Nappa leather* . Includes all the contents of leather package 1 (PYA/S3G) plus: leather-covered seat backrest covers, door armrests and handles. Seat-side trims and add-on parts are colour-coordinated. Only available in combination with CA/CF interior trim	—	●	●	●	●	£2,866.67	£3,440.00
PYJ S3G	Audi exclusive leather package 2 in Fine Nappa leather with Sports seats*** . Includes all the contents of leather package 2 plus: leather-covered front Sports seats. Seat side trims and add-on parts colour-coordinated. Only available in combination with Carbon or Piano finish black inlays (STU/STL) on all models excluding SE	●	—	—	—	—	£4,679.17	£5,615.00
YSP S3G	Audi exclusive leather package 3 in Fine Nappa leather with Sports seats** . Includes all the contents of leather package 2 (PYJ) plus: front centre console, door armrests and handles, upper and lower door trims, upper and lower dashboard (7HD) and instrument cowl in Fine Nappa leather. Only available in combination with Alcantara headlining (PL2/PL6), manual blinds (3Y3) and Carbon or Piano finish black inlays (STU/STL)	—	●	●	●	●	£5,704.17	£6,845.00
YYB S3G	Audi exclusive piping . Only available in combination with an Audi exclusive leather package (PYA/PYG/PYD/PYJ/YSP)	—	●	●	●	●	£4,787.50	£5,745.00
		—	●	●	●	●	£9,920.83	£11,905.00
		●	●	●	●	●	No charge	No charge

Options are subject to availability and may extend delivery.

- = Not available
- = Available
- S = Standard

*Leather, stitching and piping (where applicable) can be specified in a variety of colours from the Audi exclusive range shown on page 46.

**The floor mats and carpet colour can be selected from any of the Audi exclusive colours shown on page 46.

*Please see available dashboard colours on page 46.

**On SE, only available in combination with CA/CF interior trim. On S line, S line Plus, S line Style and S line Sport editions, only available in combination with Carbon inlay (STU) or Piano finish, black inlay (STL).

RRP – Recommended Retail Price.

VAT is calculated at 20% but this may alter to reflect any change in the applicable VAT rate.



Audi exclusive leather package 1

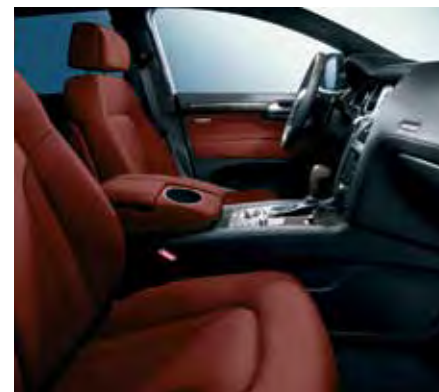

Audi exclusive leather package 2



Audi exclusive leather package 3

Upholstery

Audi exclusive interior options

Order Code		SE	S line	S line Plus	S line Style Edition	S line Sport Edition	Basic RRP	Total RRP inc VAT
YRI S3G	Audi exclusive part-wood, part-leather steering wheel* . Wood and leather can be chosen from the Audi exclusive inlays and leather colours. Only available in combination with matching Audi exclusive inlays (YTA). Not available in combination with 4-spoke multi-function steering wheel – heated, with gear shift paddles (2ZD) and Audi lane assist (PU1/PU2) or Piano finish, black inlay (STL)	●	–	–	–	–	£554.17	£665.00
YRB S3G	Audi exclusive controls package* . Includes leather-covered steering wheel and gear-shift gaiter	●	●	●	●	●	£466.67	£560.00
YSR S3G	Audi exclusive floor mats with leather piping** . Includes 4 floor mats for front and rear. Not available in combination with Audi exclusive carpets (YSQ)	●	●	●	●	●	£295.83	£355.00
YSQ S3G	Audi exclusive carpets** . Includes 4 Audi exclusive floor mats with leather piping. Not available in combination with Audi exclusive floor mats (YSR)	●	●	●	●	●	£1,191.67	£1,430.00
YUR S3G	Audi exclusive headlining in black Alcantara . Stitching can be specified in a variety of colours from the Audi exclusive range	●	–	–	–	–	£1,870.83	£2,245.00
		–	●	●	●	●	£1,658.33	£1,990.00
YZV S3G	Audi exclusive rear reading lights . With manually adjustable light cone. Not available in combination with Panoramic sunroof (3FU/3FV)	●	●	●	●	●	£766.67	£920.00

Options are subject to availability and may extend delivery.

– = Not available
● = Available
S = Standard

*Leather, stitching and piping (where applicable) can be specified in a variety of colours from the Audi exclusive range shown on page 46.

**The floor mats and carpet colour can be selected from any of the Audi exclusive colours shown on page 46.

RRP – Recommended Retail Price.

VAT is calculated at 20% but this may alter to reflect any change in the applicable VAT rate.



Audi exclusive part-wood, part-leather steering wheel



Audi exclusive carpet, including floor mats



Upholstery

Audi exclusive line

Audi exclusive is ultimately about choice – but if you'd rather leave some of the decisions in the capable hands of our designers, the expert team at quattro GmbH have compiled Audi exclusive line, combining some of the most popular elements of the exclusive range in one, beautifully coordinated package.

Order Code	SE	S line	S line Plus	S line Style Edition	S line Sport Edition	Basic RRP	Total RRP inc VAT
WQ7 YED	–	•	•	–	–	£2,212.50	£2,655.00

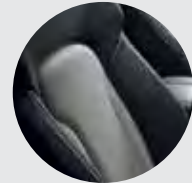

Silver – QL

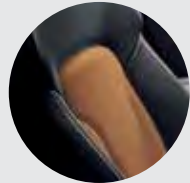

Cognac brown – QX

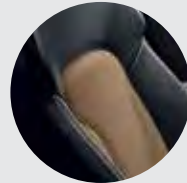

Sand beige – QV

This package includes:

- ▶ Two-tone Valcona leather upholstery. Seat centres in Silver (QL), Cognac brown (QX) or Sand beige (QV). Seat-side sections and head restraints in black with decorative stitching to match seat centres
- ▶ Door trim inserts in Valcona leather to match seat centres
- ▶ Black dashboard and carpets
- ▶ Black cloth headlining
- ▶ Audi exclusive door sill trims
- ▶ Matt-brushed aluminium inlays
- ▶ Black front and rear floor mats with leather piping to match seat centres
- ▶ 3-spoke Sports multi-function steering wheel in black leather and gear-lever gaiter with stitching to match seat centres



Door trim inserts in contrast colour



Gear-lever gaiter with contrast stitching



Steering wheel with contrast stitching

Options are subject to availability and may extend delivery.

– = Not available
• = Available
S = Standard

RRP – Recommended Retail Price.

VAT is calculated at 20% but this may alter to reflect any change in the applicable VAT rate.



Image shows optional Audi exclusive line Silver (QL)

Inlays

Attention to detail can make a big impact. From contemporary black gloss to a natural walnut, our selection of inlays offers the perfect finishing touch to your car's interior.





Inlays

Inlays are the all-important finishing touch that add flair and interest to your car's interior.

Order Code		SE	S line	S line Plus	S line Style Edition	S line Sport Edition	Basic RRP	Total RRP inc VAT
5TE	Aluminium trigon	S	-	-	-	-	No charge	No charge
5TG	Matt-brushed aluminium	-	S	S	S	S	No charge	No charge
5TS	Walnut, natural	●	-	-	-	-	No charge	No charge
5MQ	Olive ash, beige	●	-	-	-	-	No charge	No charge
5TA	Tamo ash, dark brown	●	-	-	-	-	No charge	No charge
5TL	Piano finish, black	-	●	●	●	●	£279.17	£335.00
5TU	Carbon	-	●	●	●	●	£825.00	£990.00

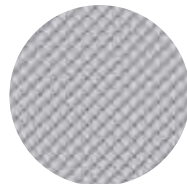

Aluminium trigon – 5TE

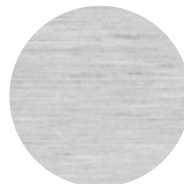

Matt-brushed aluminium – 5TG

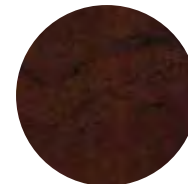

Walnut, natural – 5TS



Olive ash, beige – 5MQ



Tamo ash, dark brown – 5TA

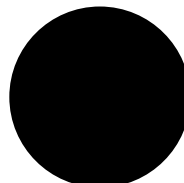

Piano finish, black – 5TL



Carbon – 5TU

Options are subject to availability and may extend delivery.

- = Not available
- = Available
- S = Standard

RRP – Recommended Retail Price.

VAT is calculated at 20% but this may alter to reflect any change in the applicable VAT rate.

Inlays

Audi exclusive

Audi exclusive has sourced a varied range of materials from which to craft these elements – from fine grain ash, nougat to clean, contemporary Piano finish, black.

Order Code		SE	S line	S line Plus	S line Style Edition	S line Sport Edition	Basic RRP	Total RRP inc VAT
YTA S3G	Audi exclusive inlays (cannot be combined with the inlays shown on page 54)	●	●	●	●	●	£766.67	£920.00
YTD S3G	Audi exclusive gear lever in wood (Only available in combination with matching Audi exclusive inlays YTA)	●	●	●	●	●	£170.83	£205.00

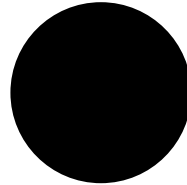

Piano finish, black - 5TL*



Fine grain ash, nougat



Fine grain myrtle, nutmeg

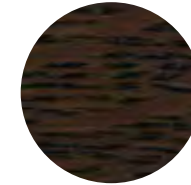

Oak, sepia

Options are subject to availability and may extend delivery.

- = Not available
- = Available
- S = Standard

*Piano finish, black inlay available on S line, S line Plus, S line Style Edition and S line Sport Edition at a lower price, as shown on page 54.

RRP – Recommended Retail Price.

VAT is calculated at 20% but this may alter to reflect any change in the applicable VAT rate.



Options

Every driver has different needs, which is why we have created some useful options to further enhance your car. For extra comfort, support, style or function, you can choose from a variety of additional features, tailoring everything from your infotainment and audio equipment to your wheels and lighting.





Wheels and tyres

Choose a set of specially selected alloy wheels to subtly enhance the way your car looks and drives.



19" x 8.5J '5-arm V' design alloy wheels - PRL



20" x 9J '10-spoke V' design alloy wheels - PRM



20" x 10J '20-spoke' design two-piece alloy wheels - PQS



20" x 10J '10-spoke' design alloy wheels - PQ5



21" x 10J '5-segment-spoke' design alloy wheels - PQ6



21" x 10J '5-segment-spoke' design alloy wheels in titanium finish - PQ8



21" x 10J '7-double-spoke' design alloy wheels - PQF



21" x 10J '7-double-spoke' design polished alloy wheels - PQN



21" x 9J '5-arm Rotor' design matt titanium finish alloy wheels - PQW

Wheels and tyres

Order Code		SE	S line	S line Plus	S line Style Edition	S line Sport Edition	Basic RRP	Total RRP inc VAT
PRL	19" x 8.5J '5-arm V' design alloy wheels with 265/50 R19 110Y tyres	S	-	-	-	-	No charge	No charge
PQR	20" x 9J '5-spoke' design alloy wheels with 275/45 R20 107Y tyres**	-	S	-	-	-	No charge	No charge
PRM	20" x 9J '10-spoke V' design alloy wheels with 275/45 R20 110Y tyres	●	-	-	-	-	£654.17	£785.00
PQ5	20" x 10J '20-spoke' design two-piece alloy wheels with 295/40 R20 107Y tyres*	●	-	-	-	-	£1,391.67	£1,670.00
		-	●	-	-	-	£337.50	£405.00
PQ5	20" x 10J '10-spoke' design alloy wheels with 295/40 R20 110Y tyres*	●	-	-	-	-	£1,391.67	£1,670.00
		-	●	-	-	-	£337.50	£405.00
		●	-	-	-	-	£1,862.50	£2,235.00
PQ6	21" x 10J '5-segment-spoke' design alloy wheels with 295/35 R21 107Y tyres*	-	●	S	-	-	£808.33	£970.00
		-	-	-	-	●	No charge	No charge
		●	-	-	-	-	£1,945.83	£2,335.00
PQ8	21" x 10J '5-segment-spoke' design alloy wheels in titanium finish with 295/35 R21 107Y tyres*	-	●	-	-	-	£891.67	£1,070.00
		-	-	●	-	-	£83.33	£100.00
		-	-	-	-	S	No charge	No charge
		●	-	-	-	-	£1,987.50	£2,385.00
PQF	21" x 10J '7-double-spoke' design alloy wheels with 295/35 R21 107Y tyres*	-	●	-	-	-	£933.33	£1,120.00
		-	-	●	-	-	£125.00	£150.00
		●	-	-	-	-	£2,329.17	£2,795.00
PQN	21" x 10J '7-double-spoke' design polished alloy wheels with 295/35 R21 107Y tyres*	-	●	-	-	-	£1,275.00	£1,530.00
		-	-	●	-	-	£466.67	£560.00
PQW	21" x 9J '5-arm Rotor' design alloy wheels in matt titanium finish with 275/40 R21 107Y tyres*	-	-	-	S	-	No charge	No charge

Options are subject to availability and may extend delivery.

- = Not available
● = Available
S = Standard

*Please note, this option includes a small extension to the wheel arches.

**For image please refer to page 22.

RRP – Recommended Retail Price.

VAT is calculated at 20% but this may alter to reflect any change in the applicable VAT rate.

Packages

Some items work well together, which is why we've created these special packages. They provide increased convenience and value by combining several of our most popular options.

Order Code		SE	S line	S line Plus	S line Style Edition	S line Sport Edition	Basic RRP	Total RRP inc VAT
WB0 9ZW UF7	Technology package: ▶ Satellite Navigation system – HDD-based ▶ Colour Driver's Information System (DIS) with efficiency programme ▶ Single CD/DVD player ▶ Mobile phone preparation – High with Audi connect	●	●	S	S	S	£1,850.00	£2,220.00
	▶ Power-operated tailgate ▶ DSP sound system ▶ Voice dialogue system ▶ Audi parking system advanced ▶ Audi Music Interface							

Satellite Navigation system Plus. Hard disk navigation with topographical map display, places of interest and town models in 3D, with high-resolution 7" colour TFT display. The system offers three alternative routes, with the ability to scroll along the selected route and manoeuvre within the map. Uses 7-digit postcode recognition. Includes split-screen mode for route information, dynamic route guidance (TMC), intersection zoom function, motorway exits and lane recommendations in Driver's Information System (DIS). Includes 2 SD card readers, single CD/DVD player, 40GB hard drive and Jukebox (20GB) for storing and managing music files in WMA and MP3 format. Includes European navigation data (where digitised).

Mobile telephone preparation – High with Audi connect. Audi connect provides access to a number of innovative online services via an internal UMTS (3G) module. Audi connect online services include: navigation using Google Earth images and Google Street View, destination entry via Google Maps or myAudi, online point of interest search and information services such as weather forecasts and the latest world news. Audi connect also includes Audi traffic information online, which gives accurate real-time forecasts of the traffic situation along the chosen route. The traffic situation can be displayed on the navigation map or Google Earth image. Audi connect can also create a Wi-Fi hotspot in the car for convenient internet access using a mobile device (e.g. laptop or tablet). Many Audi connect features can be simply operated via MMI, the multi-function steering wheel or the voice control system

Important connectivity information: An external data source is required to enable the Audi connect online services. One of the two following external data sources can be used¹:

1. A mobile telephone with Bluetooth SIM Access Profile²
2. A separate SIM card which can be inserted in the included SIM card reader. When a separate SIM card is used, hands free phone calls are possible using the SIM card or by connecting a different mobile telephone via Bluetooth Hands Free Profile

Options are subject to availability and may extend delivery.

- = Not available
- = Available
- S = Standard

¹Online services are only available for mobile phone contracts or SIM cards which include a data option and only within the coverage of the mobile phone network; there may be additional costs for the use of these services (charges and billing correspond to the personal mobile phone contract or SIM card contract). Due to high data volumes, a mobile phone contract including an unlimited or high usage data plan is strongly recommended. The content and scope of the online based services offered may vary.

²To check the compatibility of your mobile phone and whether it has SIM Access Profile compatibility, please visit www.audi.co.uk/owners-area/phone-compatibility.html

RRP – Recommended Retail Price.

VAT is calculated at 20% but this may alter to reflect any change in the applicable VAT rate.



Packages

Options are subject to availability and may extend delivery.

- = Not available
 • = Available
 S = Standard

**When Off-road styling package (YND) is ordered with a sunroof (3FU/3FV) and electric trailer towing hitch (1D9), deletion of third seating row (5KM) must be added.

Off-road styling package (YND) not available in combination with 20"/21" wheels with tyre size 295.

RRP - Recommended Retail Price.

VAT is calculated at 20% but this may alter to reflect any change in the applicable VAT rate.

Order Code	SE	S line	S line Plus	S line Style Edition	S line Sport Edition	Basic RRP	Total RRP inc VAT
WB7 PV6 Comfort package: ▶ Advanced key ▶ Electrically adjustable steering column with memory ▶ Electrically adjustable front seats with memory ▶ Electrically folding, heated, auto-dimming door mirrors with memory	•	•	•	•	•	£1,233.33	£1,480.00
WTC 1D2 Load package: ▶ Towing bracket – removable and lockable ▶ Load-securing set with rails ▶ Reversible luggage compartment mat ▶ Net partition	•	•	•	•	•	£708.33	£850.00
YND Off-road styling package:** ▶ Front and rear lower bumper spoilers with stainless steel under-body protection ▶ Side door lower protection strips ▶ Stainless steel running boards ▶ Wheel arch extensions ▶ Front bumper protection strips ▶ Reshaped exhaust tailpipes	•	-	-	-	-	£2,129.17	£2,555.00
PX4 8Q7 Visibility package: ▶ Adaptive headlights ▶ Xenon Plus headlights with LED daytime-running lights and LED indicators ▶ Headlight washers	•	-	-	-	-	£725.00	£870.00
	-	•	•	•	•	£400.00	£480.00

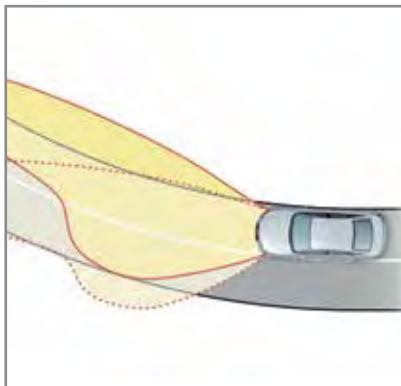

Adaptive headlights – part of the Visibility package



Xenon Plus headlights – part of the Visibility package



The Off-road styling package



Colour Driver's Information System – part of the Technology package

Audio and communication

Stay in touch using our range of communication functions, and give each journey its own soundtrack with our advanced audio equipment.

Order Code		SE	S line	S line Plus	S line Style Edition	S line Sport Edition	Basic RRP	Total RRP inc VAT
8RY	BOSE® surround sound system. Dynamic noise compensation, 8-channel amplifier, 13 loudspeakers including centre speaker in the dashboard and 2 surround loudspeakers in the rear shelf. Total output of 330 watts. 5-channel surround sound	●	●	●	●	●	£487.50	£585.00
8RF	Bang & Olufsen Advanced Sound System. Surround sound reproduction with dynamic compensation for road noise. 5-channel amplifier, 14 loudspeakers with total output of 1,000 watts, motorised Acoustic Lens speakers in dashboard, aluminium loudspeaker grilles for all other visible speakers, 14-channel Digital Signal Processing (DSP). Four different settings are available to adapt sound to the seat positions. Only available in combination with deluxe automatic air conditioning (9AH) and Technology package (WBO). Only available on the 4.2 TDI engine	—	●	●	●	●	£3,829.17	£4,595.00
PT5	Mobile telephone preparation – Low with Bluetooth and voice control. Provides hands-free connection via Bluetooth using mobile phone aerial. Alternatively, it can use a cradle with charging facility for optimal reception via external aerial. Located in front centre armrest. Cradle available at extra cost – please contact your Audi Centre for phone compatibility	●	●	—	—	—	£145.83	£175.00

Options are subject to availability and may extend delivery.

- = Not available
- = Available
- S = Standard

RRP – Recommended Retail Price.

VAT is calculated at 20% but this may alter to reflect any change in the applicable VAT rate.

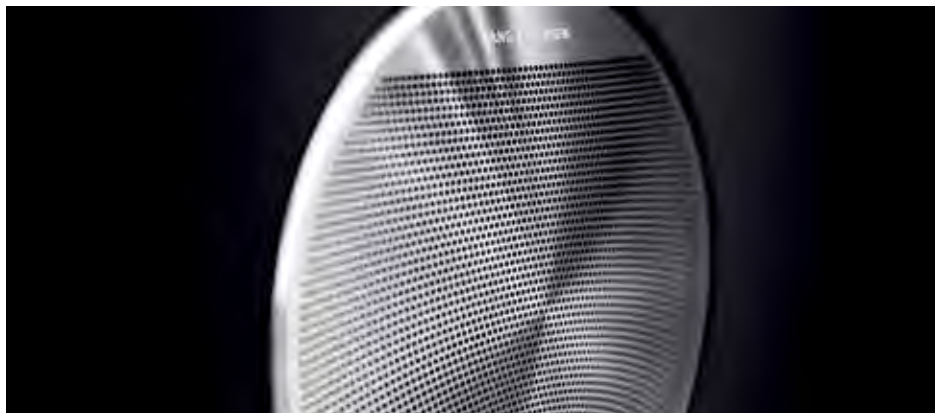

Bang & Olufsen Advanced Sound System



Bang & Olufsen Advanced Sound System

Audio and communication

Order Code		SE	S line	S line Plus	S line Style Edition	S line Sport Edition	Basic RRP	Total RRP inc VAT
UF7	Audi Music Interface (AMI). Universal connection for use with stereo audio sources, USB and MP3 devices including Apple iPod generation 4 onwards (iPod, iPod classic, iPod mini, iPod nano, iPod photo, iPod video, iPod touch). Provides intuitive control through the audio system and multi-function steering wheel. It also replicates the iPod display on the audio screen and DIS, including track titles. The interface provides charging function (dependent on device). Includes 2 cables to connect your iPod or USB MP3 player device	●	●	S	S	S	£212.50	£255.00
7D1	CD changer. For six CDs with MP3 compatibility. Operated via MMI system. Located in centre console. When ordered with MMI system, a single CD player is fitted under the centre armrest. Only available in combination with Technology package (WBO)	●	●	●	●	●	£270.83	£325.00
9Q8	Driver's Information System (DIS) – colour. With efficiency programme	●	●	S	S	S	£108.33	£130.00
9WM	Audi Entertainment Mobile. Includes two 9-inch screens* supplied by Audi Genuine Accessories which can be easily fitted and includes the ability to connect modern storage devices such as Bluetooth interface, CD/DVD-drive, SD-card slot, USB-interface and AV-IN/OUT. Includes a carry case for player and accessories, remote control, table-top stand, battery for 2.5 hours external player time, charging lead, headphones, operating instructions and a bonus DVD. The back of both front seats are fitted with mountings and wiring, and the system can also be used outside the car with the rechargeable battery	●	●	●	●	●	£875.00	£1,050.00
9WP FE2	Rear Seat Entertainment System Plus. Comprising 6-disc DVD player in luggage compartment, 2x7" monitors in the front head restraints with separate TV/DVD/AUX input for each screen, connections for AUX input such as games console, sound output through vehicle sound system or headphones, and analogue and digital TV reception. Includes 2 sets of headphones. This option deletes the standard collapsible spare wheel and replaces it with tyre mobility system. Only available in combination with Technology package (WBO) and TV reception (QU6), and on 3.0 TDI engines also with BOSE® surround sound system (8RY)	●	●	●	●	●	£3,575.00	£4,290.00
QU6	Digital TV reception. TV tuner for reception of 'free-to-air' TV channels. Picture display only possible on MMI screen when vehicle is stationary, audio available at all times. Reception dependent upon local digital network availability. Only available in combination with Technology package (WBO)	●	●	●	●	●	£670.83	£805.00

Options are subject to availability and may extend delivery.

- = Not available
- = Available
- S = Standard

*Screens must be ordered by the Audi Centre via Audi Genuine Accessories.

RRP – Recommended Retail Price.

VAT is calculated at 20% but this may alter to reflect any change in the applicable VAT rate.



Interior equipment

Specify every detail of your car's interior with this range of exclusive options.

Options are subject to availability and may extend delivery.

- = Not available
- = Available
- S = Standard

RRP – Recommended Retail Price.

VAT is calculated at 20% but this may alter to reflect any change in the applicable VAT rate.

Order Code		SE	S line	S line Plus	S line Style Edition	S line Sport Edition	Basic RRP	Total RRP inc VAT
4F2	Advanced key. Access and authorisation system which automatically exchanges data between key and vehicle, allowing the driver to keep the key in their pocket or bag at all times. To unlock and open, simply lift the exterior door handle. To lock, press the button on the handle. Pressing the start/stop button integrated in the centre console starts and stops the engine	•	•	•	•	•	£812.50	£975.00
6NQ	Cloth headlining – black. Only available in combination with upholstery codes CA, FP, FQ or FR	•	S	S	S	S	£212.50	£255.00
PL6	Alcantara headlining – with contrast stitching and retractable sun visors. The headlining is in light grey or linen beige depending on interior chosen. When ordered with S line interiors the headlining is light grey	•	-	-	-	-	£937.50	£1,125.00
		-	•	•	•	•	£725.00	£870.00
PL2	Alcantara headlining – black, with light grey stitching. Also includes retractable sun visor. On SE models only available in combination with upholstery codes FP, FQ, CA	•	-	-	-	-	£1,487.50	£1,785.00
		-	•	•	•	•	£1,275.00	£1,530.00
9AH	Deluxe automatic air conditioning at the rear. Temperature settings and air distribution can be adjusted at the rear on the C-pillar outlets. Passengers can adjust rear air conditioning via controls in the centre console at rear or via air-conditioning controls at front	•	•	•	•	•	£466.67	£560.00
2C7	Electrically adjustable steering column. Adjustment for height and reach with auto easy-entry-and-exit function	•	•	•	•	•	£254.17	£305.00
PAD	Folding tables on the front seat backrests	•	•	•	•	•	£66.67	£80.00



Deluxe automatic air conditioning at the rear



Advanced key start/stop button

Interior equipment

Options are subject to availability and may extend delivery.

- = Not available
- = Available
- S = Standard

*HomeLink® is a registered trademark of Johnson Controls. For information on compatibility, visit www.homelink.com

RRP – Recommended Retail Price.

VAT is calculated at 20% but this may alter to reflect any change in the applicable VAT rate.

Order Code		SE	S line	S line Plus	S line Style Edition	S line Sport Edition	Basic RRP	Total RRP inc VAT
VC1	Garage door opener (Homelink®). Programmable radio-operated remote control for compatible doors/gates. Control buttons integrated in the front roof module	•	•	•	•	•	£150.00	£180.00
7HB	Leather package. Includes front centre console, door armrest and door handles in Fine Nappa leather	•	•	•	•	•	£595.83	£715.00
7HD	Leather package advanced. As leather package plus dashboard and door shoulder line in Fine Nappa leather. Only available in combination with Alcantara headlining (PL2/PL6) and manual blinds (3Y3). On SE models, only available in combination with Visibility package (PX4/8Q7). On SE models stitching is in Silver, on S line models stitching is in Black	•	•	•	•	•	£3,829.17	£4,595.00
3GN	Load-area fixing kit. Includes telescopic bar and securing belt for dividing up luggage compartment	•	•	•	•	•	£150.00	£180.00
9JA	Non-smoking pack. Replaces ashtray and cigarette lighter with 12V socket and centre storage compartment. Ashtrays in rear door armrests unchanged	•	•	•	•	•	No charge	No charge
3Y3	Rear window and side window blinds – manual	•	•	•	•	•	£175.00	£210.00
3CX	Removable net partition. Located between rear seats and rear luggage compartment. Can be used with rear seat-back in upright position, one side folded down, or completely folded down	•	•	•	•	•	£87.50	£105.00
65J	Reversible load floor mat. Luggage compartment floor mat can be reversed to provide a rubber mat which extends to protect rear bumper. Includes bumper cover	•	•	•	•	•	£70.83	£85.00



Load-securing set with rails



Leather package advanced

Exterior equipment

Make sure your car looks exactly as you want it to by selecting some of our striking options.

Order Code		SE	S line	S line Plus	S line Style Edition	S line Sport Edition	Basic RRP	Total RRP inc VAT
4ZM	Black styling package. Includes radiator grille, window surround and number plate holder in matt black, radiator grille frame in high-gloss black, and black roof rails	●	●	●	●	—	£383.33	£460.00
2Z7	Deletion of engine capacity designation at rear	●	●	●	●	●	No charge	No charge
2Z0	Deletion of model and engine capacity designation at rear	●	●	●	●	●	No charge	No charge
6XK	Door mirrors – electrically folding, heated and auto-dimming	●	●	●	●	●	£137.50	£165.00
PAP	Full paint finish and chrome package. Bumpers are painted in body colour with matt finish	●	—	—	—	—	£520.83	£625.00
3FU	Panoramic sunroof.** Large 3-piece panoramic glass sunroof, extending to the third row of seats. Electrical operation for tilting and opening the front glass section, tinted glass insert, adjustable sun-shield above the whole glass surface, electrically adjustable at front, manually adjustable at rear. Automatic close function from outside via central-locking	●	●	●	●	●	£1,062.50	£1,275.00
3FV	Panoramic sunroof dark tinted.** Large 3-piece panoramic glass sunroof, extending to the third row of seats. Electrical operation for tilting and opening the front glass section, tinted glass insert, adjustable sun-shield above the whole glass surface, electrically adjustable at front, manually adjustable at rear. Automatic close function from outside via central-locking	●	●	●	●	●	£1,145.83	£1,375.00
4E9	Power-operated tailgate. Opens by pressing button on the car key, button in the driver's door trim or soft-touch button in the handle recess on the luggage compartment lid. Includes lid-closing assistance unit and programmable angle for the luggage compartment lid	●	●	S	S	S	£320.83	£385.00
YNB	Stainless steel running boards**	●	●	S	S	S	£595.83	£715.00
1D9	Towing bracket – electrically folding.** Electrically folding ball head operated via button in the luggage compartment, including trailer stabilisation via the Electronic Stability Programme. Includes single 13-pin electric socket. Please contact your local Audi Centre if you require a 13- to 7-pin adaptor*	●	●	●	●	●	£725.00	£870.00
	In combination with load package (WTG)	●	●	●	●	●	£170.83	£205.00
1D2	Towing equipment – removable. Factory-fitted and removable. Includes single European 13-pin electrical socket and may require a 13- to 7-pin adaptor. Please consult your Audi Centre for details*	●	●	●	●	●	£554.17	£665.00

Options are subject to availability and may extend delivery.

– = Not available
● = Available
S = Standard

*Additional wiring is required for auxiliary equipment.

**When ordering Stainless steel running boards (YNB) with a Sunroof (3FU/3FV) and Electric trailer towing hitch (1D9) then Deletion of third seating row (SKM) must be added.

RRP – Recommended Retail Price.

VAT is calculated at 20% but this may alter to reflect any change in the applicable VAT rate.



Safety and security

Intelligent technology designed to give you better all-round awareness and safety on the road.

Options are subject to availability and may extend delivery.

- = Not available
- = Available
- S = Standard

RRP – Recommended Retail Price.

VAT is calculated at 20% but this may alter to reflect any change in the applicable VAT rate.

Order Code		SE	S line	S line Plus	S line Style Edition	S line Sport Edition	Basic RRP	Total RRP inc VAT
7X2	Audi parking system plus. Aids parking by acoustically and visually indicating distances to obstacles	•	•	-	-	-	£270.83	£325.00
KA2 7X2	Audi parking system advanced with reversing camera. Aids parking by acoustically and visually indicating distances to obstacles with guiding lines. Measured by sensors and reversing	•	•	S	S	S	£604.17	£725.00
KA4	Audi parking system advanced with corner view. Aids parking and manoeuvring with the help of guiding lines, providing a reversing camera concealed in the handle of the luggage compartment lid, and additional display modes for the front-left and right, and rear-left and right. Only available in combination with Technology package (WB0)	•	•	•	•	•	£208.33	£250.00
PU1	Audi lane assist. Uses a discreet camera mounted at the top of the windscreen to monitor the road ahead. The driver is warned with a vibration of the steering wheel if the vehicle is about to exit its lane unintentionally. Only available in combination with a 4-spoke multi-function steering wheel. Not available in combination with Audi exclusive line (WQ7/YED). Only available in combination with 4-spoke multi-function leather steering wheel (2ZD) on all models excluding SE. Please use order code PU2 for Audi lane and side assist together	•	•	•	•	•	£341.67	£410.00
7Y1	Audi side assist. Aids the driver when changing lane. Audi side assist monitors the area behind your car using radar sensors located discreetly in the rear bumper, informing the driver with a visual warning signal in the door mirror if there is a vehicle in their blind spot or approaching quickly from behind. The system is activated using a button in the driver's door. Please use order code PU2 for Audi lane and side assist together	•	•	•	•	•	£383.33	£460.00
4K5	Privacy glass. Dark tinted glass from B-pillar backwards	•	•	S	S	S	£325.00	£390.00
8N7	High-beam assist. Automatically adjusts headlights from high-beam to dipped-beam when another vehicle is approaching	•	•	•	•	•	£95.83	£115.00
4X4	Rear side airbags. Situated in side of rear seats	•	•	•	•	•	£212.50	£255.00



Audi parking system advanced with reversing camera

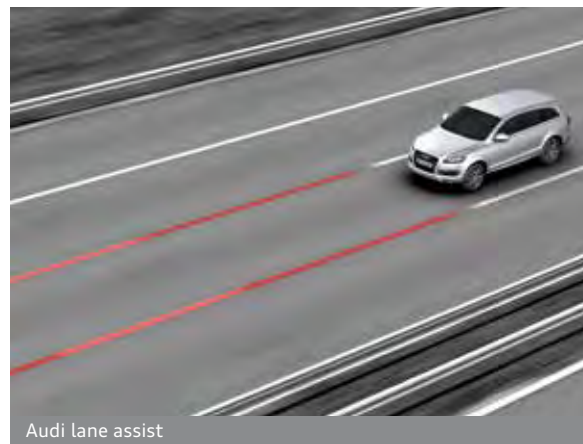

Audi lane assist

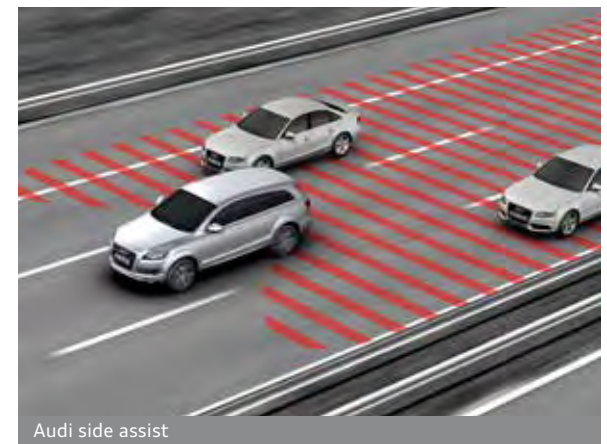

Audi side assist

Steering wheels

You can choose from a selection of advanced leather multi-function steering wheels, allowing you to control your audio system at the touch of a button.

Order Code		SE	S line	S line Plus	S line Style Edition	S line Sport Edition	Basic RRP	Total RRP inc VAT
1XX	3-spoke multi-function steering wheel with gear-shift paddles. Includes S line badging on S line models only	●	S	S	S	S	£179.17	£215.00
2ZD	4-spoke multi-function leather steering wheel – heated, with gear-shift paddles. Only available in combination with Audi lane assist (PU1/PU2). Not available in combination with Audi exclusive line (WQ7/YED) or Audi exclusive steering wheel in wood and leather (YRI)	●	●	●	●	●	£225.00	£270.00
2Z5 6F9	4-spoke multi-function leather/wood steering wheel with gear-shift paddles. Only available in combination with Walnut natural inlays (5TS)	●	–	–	–	–	£450.00	£540.00

Options are subject to availability and may extend delivery.

- = Not available
- = Available
- S = Standard

RRP – Recommended Retail Price.

VAT is calculated at 20% but this may alter to reflect any change in the applicable VAT rate.



Looking after your Audi

When you've chosen your ideal model, it's reassuring to know that it will remain in safe hands. That's why we've created products to protect your Audi: from extended warranties to Audi Complete – our comprehensive service and maintenance package. And there's also a range of Audi accessories and merchandise to choose from, enabling you to further enhance and safeguard your car.





Audi Complete

Audi Complete is simply a way to look after the servicing and maintenance costs for your Audi in a single package. You pay a one-off or monthly fee and we'll cover all your servicing, maintenance and tyres for the next three years including your MOT. It means you only have to pay for fuel, insurance and your Road Fund Licence. So you can be reassured that your car will be maintained by trained Audi Technicians, using genuine Audi parts. You can also opt for our Service only or Service and Maintenance packages if you prefer.

*Retail customers only. Pricing correct at time of print and based on a 3 years/30,000 miles agreement. All pricing is a 'starting from' price for the Audi Q7 model range and is therefore subject to change and mileage/ model dependent. If you drive under 10,000 miles per annum your vehicle will be placed on a fixed inspection service schedule. If your mileage tends to exceed 10,000 miles per annum it will be placed on the Flexible Service schedule.

Warranty

Options are subject to availability and may extend delivery.

- = Not available
● = Available
S = Standard

**Only available prior to registration of your Audi Q7. Please speak to your Audi Centre for full details.

RRP – Recommended Retail Price.

VAT is calculated at 20% but this may alter to reflect any change in the applicable VAT rate.

Order Code		Q7	Basic RRP	Total RRP inc VAT
-	Audi Complete – Service only. Comprehensive care for your Audi covering all your servicing for 3 years. Visit your local Audi Centre for further information or audi.co.uk/audicomplete for full details including terms and conditions	●	£15.83	£19.00*
-	Audi Complete – Service and Maintenance. Comprehensive care for your Audi covering all your servicing and maintenance for 3 years, as well as your MOT. Visit your local Audi Centre for further information or audi.co.uk/audicomplete for full details including terms and conditions	●	£23.33	£28.00*
-	Audi Complete – Service, Maintenance and Tyres. Comprehensive care for your Audi covering all your servicing, maintenance and tyres for 3 years, as well as your MOT. Visit your local Audi Centre for further information or audi.co.uk/audicomplete for full details including terms and conditions	●	£41.67	£50.00*

Order Code		Q7	Basic RRP	Total RRP inc VAT
-	Audi Warranty, covering you for unlimited mileage in the first two years of ownership, and up to 60,000 miles in the third year. Transferable between owners**	S	No charge	No charge
EA6	Audi Warranty, covering you for up to 4 years or 75,000 miles, whichever comes sooner. Cover includes a two-year unlimited mileage warranty, and up to 75,000 miles in the third and fourth years. Transferable between owners**	●	£466.67	£560.00
EA9	Audi Warranty, covering you for up to 5 years or 90,000 miles, whichever comes sooner. Cover includes a two-year unlimited mileage warranty, and up to 90,000 miles in the third, fourth and fifth years. Transferable between owners**	●	£1,112.50	£1,335.00

Accessories

Choosing an Audi isn't just a matter of deciding on the model you want – it's about creating a car that perfectly suits your needs. And that's why we've developed a whole range of accessories to enhance your Audi Q7, enabling you to customise it down to the last detail. Like your Audi, all these accessories are developed to the highest possible standards. And they're all available exclusively from Audi.

So whether you are looking for mats or a loadliner, to find out more just visit audi.co.uk/accessories or contact your local Audi Centre.

Warranty

All the accessories available on the Audi Q7 are covered by a three-year warranty* if they are ordered and included in the purchase price of the car at date of delivery. Any accessories ordered and installed after delivery include a two-year warranty.*



Audi Entertainment Mobile



Flexible load liner



Front and rear mud flaps



Combined roof bars and bike rack

*Excluding Road Angel products. Audi Accessories warranty terms and conditions can be found at audi.co.uk

Merchandise

From the enthusiasts' motorsport collection to the sophisticated Audi collection, there's a wide variety of adults' and children's clothing, lifestyle accessories and collectables, all of which bear the Audi name.

Please speak to a member of our team at your local Audi Centre to see the full Audi collection and to place an order. A selection of Audi merchandise is also available to buy from audi.co.uk/merchandise



The Audi **Difference**

The experts in Vorsprung durch Technik

Our Audi Approved Master Technicians have undergone an impressive 100,000 hours of training over a 10-year programme to ensure they have the latest technical expertise for maintaining and servicing your Audi. All our Service Advisors undergo a specialist induction and training to ensure they are Audi professionals and able to talk to you about any issues you may have with your Audi vehicle.

Servicing tailored to your needs

Regular servicing is key to safeguarding your Audi's performance and a full Audi service history could help you enhance the future re-sale value. To make servicing easy, the Audi Service Schedules have been designed to work with your individual driving style and vehicle.

We offer two different schedules: the fixed Inspection Service and the Flexible Service schedule. The conventional fixed Inspection Service schedule has fixed intervals for the Oil-change Service and Inspection Service, which are determined by time and distance.

With the Flexible Service schedule, the Inspection Service intervals are also fixed but the Oil-change Service intervals are variable. Sensors take account of driving style and conditions to determine when the Oil-change Service is required and the driver is informed via the on-board service interval display.

The choice of Service Schedule will depend on journey type and mileage as well as individual driving style and conditions. The table to the right can be used for guidance but your Audi Centre will help you to determine the most suitable Service schedule for you based on your individual circumstances and preferences.

Fixed Inspection Service Schedule

	Vehicle usage:
Mileage	Less than 10,000 miles per annum. Mainly city/town centre driving. Short journeys.
	Service Intervals:
Oil-change Service	Fixed to every 9,000+ miles/1 year
Inspection Service	Fixed to every 19,000+ miles/2 years

Flexible Service Schedule

	Vehicle usage:
Mileage	More than 10,000 miles per annum. Motorway and main road driving. Mainly longer distance journeys. Constant speeds.
	Service Intervals:
Oil-change Service	Variable to a maximum of every 19,000+ miles/2 years
Inspection Service	Fixed to every 19,000+ miles/2 years

When a vehicle is frequently used in the following conditions, we recommend a Fixed Inspection Service Schedule, regardless of mileage:

Uneconomical driving styles, e.g. heavy acceleration and braking, constant use of high revs

High engine-loading conditions, e.g. frequent towing and hill climbs

*As indicated by the service interval display. Mileages are approximate as the Service Indicator system uses kilometres as its distance measurement.

Your convenience comes first

At Audi you can choose from a range of convenient services that suit your needs. Why not book a 'service while you wait' appointment* and enjoy our complimentary refreshments while your car is with us? Or, if you need to be mobile, take advantage of one of our courtesy cars which we can even deliver to you.* We guarantee we can service your Audi within 5 days without a courtesy car or within 10 days if you need transport. We will also ensure your car is returned to you with a full valet.

Audi Genuine Parts

You can rest assured that only Audi Genuine Parts will be used on your vehicle. What's more, Audi parts and labour come with a 2-year guarantee.**

No hidden costs

We believe strongly in transparency when it comes to our prices. For added peace of mind, we will give you a quotation over the phone for the work you have requested and email you the price confirmation. We'll consult you if any additional work on your car is needed when it is with us. We won't carry out any extra work without asking your permission first.

All part of the service

Whenever we see an Audi for a service, we connect it directly to our headquarters in Ingolstadt which enables us to check your car's software and make sure it's as up-to-date as possible. If the factory has released a software upgrade for your model, it can be applied immediately - improving anything from your car's efficiency to the precision of its parking system.

Audi Roadside Assistance

Your new car comes complete with 3 years' complimentary roadside assistance and recovery across the UK, provided by Automobile Association Insurance Services Limited. Also included is roadside assistance throughout Europe, managed by Automobile Association Insurance Services Limited.

For further information and terms and conditions please visit audi.co.uk

*Subject to availability.

**Excludes wear and tear.



Audi Q7

technical data

Engine	Diesel		
	3.0 TDI quattro	3.0 TDI quattro	4.2 TDI quattro
Transmission	8-speed tiptronic	8-speed tiptronic	8-speed tiptronic
Cylinder	6-cylinder	6-cylinder	8-cylinder
Displacement, cubic cm (valves per cylinder)	2967 (4)	2967 (4)	4134 (4)
Max. power ¹ , PS at rpm	204/3200-4400	245/3800-4400	340/4000
Max. torque, Nm at rpm	450/1250-2750	550/1750-2750	800/1750-2750
Top speed ² , mph	127	135	150
0-62mph acceleration, seconds	9.1	7.8	6.4
CO ₂ emissions ³ , g/km	189	195	242
Benefit in kind (BIK)%	33%	35%	35%
Fuel consumption ³ , mpg (l/100km) Urban	34.4 (8.2)	32.8 (8.6)	23.5 (12.0)
Fuel consumption ³ , mpg (l/100km) Extra Urban	43.5 (6.5)	42.2 (6.7)	37.2 (7.6)
Fuel consumption ³ , mpg (l/100km) Combined	39.2 (7.2)	38.2 (7.4)	30.7 (9.2)
ABI insurance group 1-50*	37 E	41 E	47 E
Unladen weight ⁴ , kg	2300	2300	2440
Gross weight limit, kg	3125	3125	3265
Roof load limit/nose weight, kg	100/130	100/130	100/130
Max trailer load unbraked ⁵ , kg	750	750	750
Max trailer load with 12% gradient ⁵ , kg	3200	3200	3200
Max trailer load with 8% gradient ⁵ , kg	3200	3200	3200
Luggage compartment capacity/seats folded flat, litres	330/2035	330/2035	330/2035
Fuel tank capacity approx, litres	100	100	100
Emission standard	EU5	EU5	EU5

*Highest insurance group rating shown. Group may be lower dependent on trim level. Please visit www.thatcham.org/abigrouprating for details.

¹The given values were obtained in accordance with the specified measurement procedure (the respective current version of the Directive 80/1269/EEC).

²Top speed is achieved in 6th gear.

³Fuel consumption and CO₂ emissions figures are obtained under standardised test conditions (Directive 93/116/EEC) using a representative model. This allows direct comparison between different models from different manufacturers, but may not represent the actual fuel consumption achieved in 'real world' driving conditions. More information is available at www.vca.gov.uk

⁴Vehicle's unladen weight without driver (calculated in accordance with the current version of Directive 92/21/EEC). The fitting of additional equipment may increase the vehicle's unladen weight and drag coefficient, whereupon the potential carrying capacity and top speed will be correspondingly reduced.

⁵The engine's power output always goes down with increasing altitude. At 1,000m above sea level, and for every additional 1,000m, deduct 10% from the weight of the outfit (trailer load limit + gross weight of the towing vehicle). Value applies to trailer load for factory-fitted trailer towing hitch.

Audi Q7 dimensions

The technical drawings opposite show the exact dimensions of the Audi Q7, so you can check everything – from whether the car will fit in your garage to whether your luggage will fit in the boot.

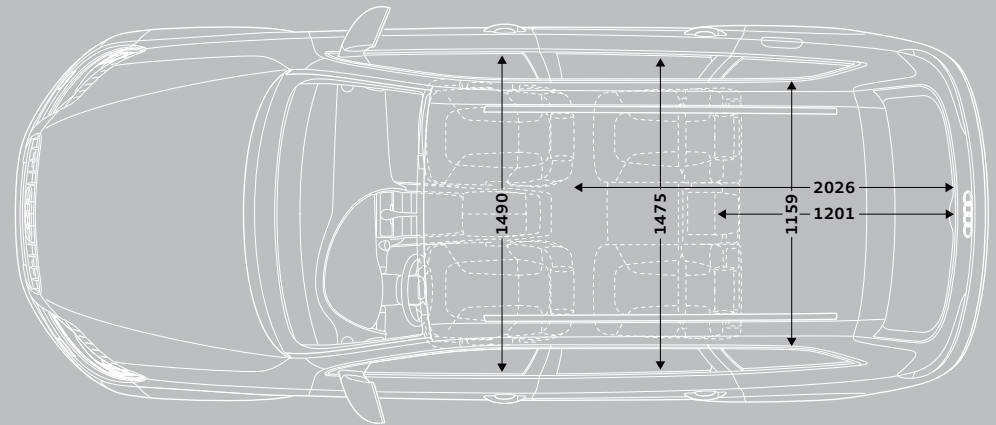
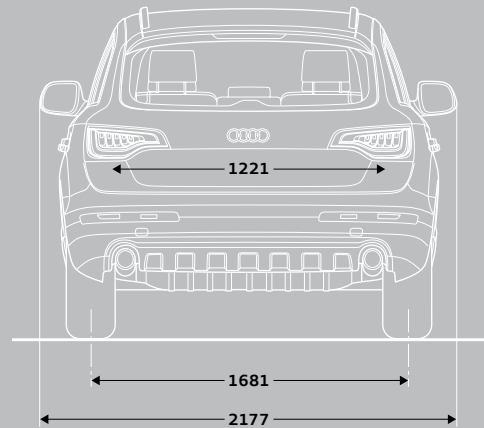
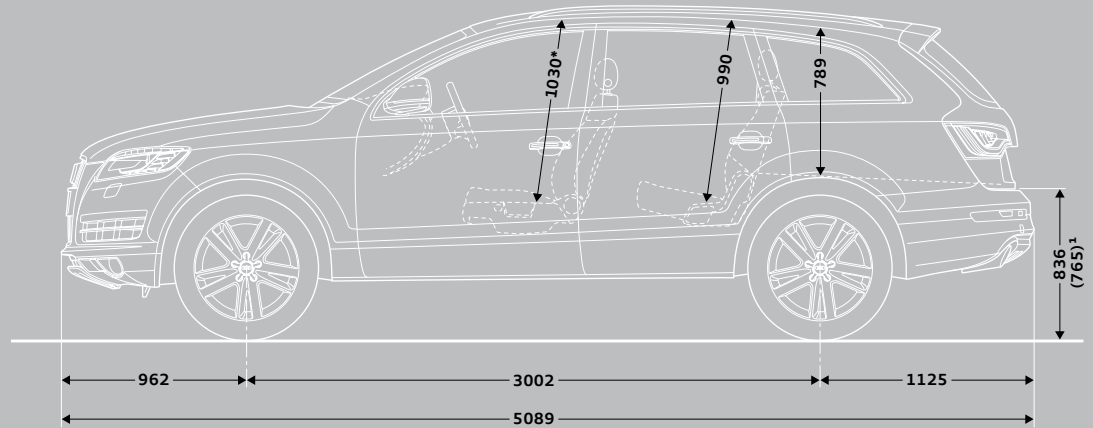
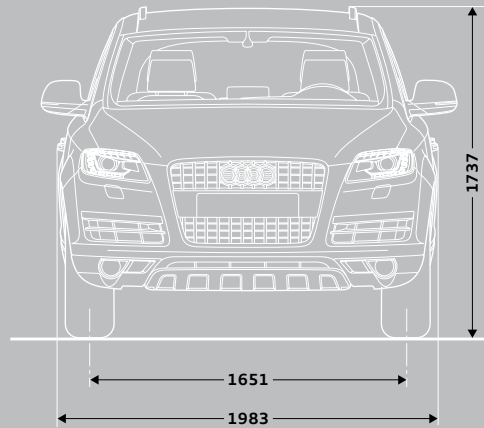

Dimensions in millimetres.

*Maximum headroom.

Dimensions measured with vehicle at unladen weight, ground clearance measured with vehicle carrying its maximum load. Luggage load area in litres: 330/2035 (measured by the VDA standard test method using 200 x 100 x 50mm blocks. Second value is with the rear seat folded down and the vehicle loaded up to the roof height).

Turning circle approx 12m.

²With air suspension, in lift mode.

Pricing and Additional information

Welcome to Audi

By placing an order for your Audi, you're choosing to get behind the wheel of one of the most sophisticated cars on the road. And because we believe the service we offer should be just as advanced, we want to let you know exactly what you can expect from us, now and in the future.

We've agreed a set of standards with all our Centres which governs the way we do business with you. It outlines the kind of service we promise to deliver for every customer, right down to filling each new Audi we sell with half a tank of fuel.

So whether you're interested in the date your car will arrive in the UK or the way we'll dispose of non-biodegradable materials after we service your Audi, you can have total confidence in us.

Audi Promise

Audi Centres

We guarantee that all our Centres will be open as follows:

Sales: Monday to Friday 9am–6pm
Saturday 9am–5pm

Service: Monday to Friday 8am–6pm
Saturday 8.30am–1pm

Sunday opening is at local discretion.

New car delivery

Once we've confirmed a delivery date for your car, we'll keep you informed of progress. Subject to reasonable notice, we'll then deliver it to a place of your choice, whether that's your home or work. In the unlikely event of a delay, we'll provide a courtesy car to minimise inconvenience and keep you mobile.

Environmental commitment

We promise to dispose of all non-biodegradable materials from your vehicle in a responsible manner.

Pricing

Prices and specifications given are correct at the time of printing. Always check details with your Audi Centre as Audi policies are continually developing. We reserve the right to change prices or specifications at any time.

All prices are subject to VAT, currently charged at 20%, but this may alter to reflect any change in the applicable VAT rate.

Delivery charges and number plates are not included in the vehicle price.

Delivery charge	£471.66
Number plate	£20.00
VAT	£98.34
Total	£590.00

Audi Customer Care

Every new Audi benefits from the comprehensive Audi Customer Care Package, which comprises:

- ▶ A 3-year Audi warranty, which covers you for unlimited mileage in the first 2 years of ownership, with a full mechanical and electrical warranty which covers you for up to 60,000 miles in the 3rd year
- ▶ A 3-year paint warranty
- ▶ A 12-year anti-corrosion warranty
- ▶ 3 years' UK roadside assistance and recovery

You also have the option when ordering your new car of choosing a 4-year or 5-year Audi warranty. Speak to a member of the sales team for more information.

Audi tax-free sales

If you are entitled to purchase a vehicle free of VAT, normally through military or diplomatic privilege, please contact your local Audi Centre for full details.

Should you have any difficulty obtaining the information you require, please call 01908 548 356.

Audi Finance

Audi Finance specialises in providing funding solutions for Audi drivers. Whether your Audi is for private or business use, there is a range of funding options to choose from.

Below is the full range of finance products, which comprises:

- ▶ Solutions – a Personal Contract Plan
- ▶ Hire purchase
- ▶ Lease purchase
- ▶ Finance lease
- ▶ Contract hire

With all products, you can choose a fixed-cost maintenance plan designed to help you budget accurately.

No matter which Audi model you choose, your local Audi Centre can provide you with a personalised quote designed to fit your budget and motoring needs.

Audi Finance is a trading name of Volkswagen Financial Services (UK) Limited. An offer of finance depends on certain conditions. Available to people over 18 in the UK only.

Audi Insurance

We want you to start enjoying your new car from day one and thanks to Audi Insurance complimentary 7-day cover, you can. Call free on 0800 316 7893 (lines are open Monday to Friday 8am–9pm, and Saturday 9am - 5pm), provide a few details and a cover note will be sent to your Audi Centre. They will then tax your car and you can drive it away.

Additional information

CO₂ data and information

CO₂ emissions-based Vehicle Excise Duty

Vehicle Excise Duty (Road Fund Licence) is based upon the amount of Carbon Dioxide (CO₂) a vehicle emits, measured in grams per kilometre (g/km). First year VED rates apply to the first year of ownership. Annual VED rates apply thereafter. The DVLA has created thirteen categories:

Petrol and Diesel engines	First year	Annual rate (second year onwards)
A – up to 100g/km	£0.00	£0.00
B – 101 to 110g/km	£0.00	£20.00
C – 111 to 120g/km	£0.00	£30.00
D – 121 to 130g/km	£0.00	£110.00
E – 131 to 140g/km	£130.00	£130.00
F – 141 to 150g/km	£145.00	£145.00
G – 151 to 165g/km	£180.00	£180.00
H – 166 to 175g/km	£290.00	£205.00
I – 176 to 185g/km	£345.00	£225.00
J – 186 to 200g/km	£485.00	£265.00
K – 201 to 225g/km	£635.00	£285.00
L – 226 to 255g/km	£860.00	£485.00
M – over 255g/km	£1,090.00	£500.00

Vehicle Excise Duty (VED) rates correct at time of going to print, but these may alter to reflect any change in the applicable VED rate.







Audi UK
Customer Services
Selectapost 29
Sheffield
S97 3FG
0800 699888
audi.co.uk

Specifications and prices subject
to change without notice.

© Audi UK

Printed in the UK
Edition 5.1 04/14
2015 model year

Images are for illustrative purposes only.

