



The new Audi TT Coupé range

Pricing and Specification Guide

Valid from August 2014

Personalising your Audi TT

This guide has been designed to help you tailor and price your Audi TT quickly and logically. At the back, you will find information on CO2 emissions-based taxation and the other services offered by Audi, including Finance and Insurance. You can also configure your Audi TT online at audi.co.uk

The new Audi TT Coupé

Audi Matrix LED lights	10
quattro®	14
Efficiency	16
Audi Virtual Cockpit	22
Audi Connect	24
Technology	26

Model details and prices

Sport model equipment	28
S line model equipment	30
Model prices	32

Colour and upholstery

Paint	34
Upholstery	38
Colour and trim guide	42

Interior styling

Options

Wheels, tyres and suspension	48
Packages	52
Audio and communication	54
Interior equipment	54
Exterior equipment	58
Safety and security	59

Looking after your Audi

Warranty	62
Accessories	66
Merchandise	67
Audi Difference	68

Technical details

Technical data	70
Dimensions	71
Pricing and Additional information	72





Vorsprung durch Technik

Three words that express the very essence of Audi. Vorsprung durch Technik isn't a slogan. It's our way of seeing the world. It is the driving force behind our history of innovation that continues into the 21st century. Indeed, many technologies that Audi pioneered remain in our cars today. Some are milestones in the history of the motorcar. From our beginnings in 1899, to the Auto Union team's Grand Prix successes in the 1930s and our more recent wins at Le Mans, we have always been at the forefront of the motor industry.

Vorsprung durch Technik makes us who we are. To see more of its influence, just read on.

Audi TT. The history of an icon.

When revolutionary design meets advanced technology, legends are born.

Indeed, when the Audi TT concept car was first unveiled to the public in 1995, it met with immediate and huge acclaim.

Few production cars resembled their concept quite as closely as this one. And, when the Audi TT first went on sale in 1998, it quickly became one of the most popular sports car in its class.

In 2006, another milestone. The second generation TT launches. With Audi Space Frame technology, it's 90kg lighter. Translating into an agile and responsive drive that garners award after award.

And now, we're unveiling the third generation TT. Unique, distinctive, unmistakably Audi: the all-new TT continues to define the notion of what a sports car should be.









The new Audi TT. Redesigned, re-engineered, reborn.

The curves, contours and proportions are familiar. But the design is sharper. The performance more powerful. The handling more responsive.

Welcome to the third generation Audi TT. An all-new iteration that combines the latest Audi technology with a striking evolution of its iconic design.

The changes begin with a wider, more imposing stance. At the front, a broad, single-framed grille flanked by dramatic, angular headlights. And at the rear, a hidden central brake light underneath a concealed spoiler that rises above speeds of 74mph.

Inside, a redesigned cabin, featuring the Audi virtual cockpit showing all driver information in a display never seen before in an Audi.

Under the bonnet, a new 2.0 TFSI petrol engine. With output increased from 211PS to 230PS, acceleration is even more responsive. And with 50kg of weight saved, the new TT is more efficient as well as more agile.

The new Audi TT. The icon is reborn.





Matrix LED lights

Look good, see better.

Far from just making a dramatic statement, optional Matrix LED headlights featured on the new Audi TT incorporate remarkable technology that adapts automatically to the car's surroundings.

Sensors and an inbuilt camera allow Matrix LED headlights to detect rear and oncoming lights of other road users, as well as ambient light in built-up areas. The technology then reacts by dipping individual LEDs to prevent dazzle, while still fully illuminating the remainder of the road.

Using the vehicle's optional navigation data, Matrix LED technology can even anticipate corners, adjusting LEDs as you negotiate the bend. The result is a much wider visual range, benefitting both you and other road users. And with dynamic, sweeping LED indicators at both front and rear, the striking look is complete.









quattro®

New TT. New quattro.

quattro reborn: our legendary all-wheel drive system returns in the new Audi TT to give you even more traction, grip and driving enjoyment.

The mechanics of quattro in the new TT have been refined and developed, but particular attention has been devoted to the controlling software.

Coupled with Dynamic mode in Audi drive select, the system that enables you to adjust the performance characteristics of your car, more torque is now distributed to the rear axle in fractions of a second for more agility on sportier drives. While in Efficiency, Comfort, Auto and Individual modes, the ideal amount of power is distributed to each wheel to maintain the new TT's perfectly balanced handling according to driving conditions and your preference.

Improved traction, better grip, more driving fun. Welcome to new quattro all wheel drive in the new Audi TT.

Efficiency

Sometimes less is more.

At Audi, doing less is something we're trying to do more of. We're constantly working to use less fuel, release less CO₂ and waste less energy. That's why we've incorporated Audi ultra technology into the new TT: to make your drive dynamic, powerful and efficient.

It begins with lightweight engineering. With Audi Space frame technology, both aluminium and steel are used for elements of the body - making the new TT up to 50kg lighter than its predecessor. So, while the car is more agile, it's less demanding at the fuel pump.

Efficiency continues with Audi drive select including Eco mode, standard on the new TT. This allows you to change the vehicle to a more frugal configuration when it suits you.

Yet, this efficiency in no way compromises performance. So while the 2.0 TDI ultra engine achieves up to 67.3 mpg and CO₂ emissions of just 110g/km, it also produces a staggering 380Nm of torque with acceleration of 0-62mph in 7.1 seconds.











Change from within.

Using our latest innovations and meticulous attention to detail, our designers created a sleek, uncluttered new cabin.

Gone is the analogue instrument cluster, replaced by the Audi virtual cockpit displaying all information from directly behind the steering wheel. This, in turn, makes for a slimmed down instrument panel.

With a stroke of inspiration, the classic TT round air vents now house air conditioning controls and optional digital displays.

Standard Sports seats in Alcantara leather with integrated headrests complete the cabin's radical new look: sharp, minimalist, sporty.

Audi Virtual Cockpit

Visible innovation.

Always evolving, ever improving: the Audi virtual cockpit, featured for the first time in the new Audi TT, sets new standards.

Located directly behind the steering wheel, a 1440 x 540 pixel, 12.3-inch digital screen shows all information directly in front of the driver. Operated via the MMI touch button, voice control and the multifunction steering wheel,

the display can be switched between 'classic', with prominent speedometer and rev counter, or 'infotainment', which brings functions such as the navigation map or media to the fore.

With brilliant graphics, a 3D impression and highly detailed effects, the Audi virtual cockpit is the embodiment of the new TT's technological innovation.





Switch views at the touch of a button

Drivers can choose their preferred view but switch easily as required, simply by pressing the 'view' button on the multi-function steering wheel.



Ultimate driver control

Virtual cockpit can be controlled using the multi-function steering wheel, the latest voice-control technology or the MMI® touch - the touch sensitive panel on the rotary/push-button in the centre console which enables the driver to enter letters and digits with their fingers - allowing for intuitive operation without taking your eyes off the road.

Audi Connect



Stay networked on the move.

Being inside your car shouldn't mean losing touch with the outside world. That's why, with Audi Connect, the new TT creates a link between you and the Internet.

With high-speed, 4G Internet access in your car, you can go online to access information, entertainment and Google Earth navigation maps by scrolling, tapping or speaking your commands. Audi Connect can even find you the cheapest fuel price in your area. And, with a wireless hotspot within the car, passengers can connect their mobile devices - to browse the Internet, download emails, or access social media.

With Audi Connect, the world stays at your fingertips.

Please note that an external data source is required to enable Audi Connect online services, please see page 73 for further details. Terms and conditions apply to certain Audi Connect functions. Please see page 73 for additional information. *Only available if your mobile phone has the bluetooth profile MAP (Message Access Profile)



Wi-fi hotspot

connects your mobile devices to the internet



Email

Your emails can be transmitted to your Audi MMI and read out conveniently'



Online Media Streaming

Pairing a smartphone with the Audi Music stream app offers access to worldwide radio stations and music stored on the smartphone



Facebook

Integrate your personal network into Audi Virtual Cockpit. With text-to-speech and other convenient text functions



Twitter

Enables you to tweet and receive updates on the move. With text-to-speech and other convenient text functions



Weather information

Gives you forecasts and maps for your chosen destination



Map update

The map version delivered can be updated free of charge with the first 5 navigation updates which are issued at intervals of 6 months



News online (individual)

Text and images from your favourite news sources with text-to-speech function



City events

Up-to-date information about events - happening at your destination



Points of interest

Search Google™ using voice control



Traffic information online

Complements the dynamic route guidance with real-time traffic flow information for individual stretches of road



myAudi – special destinations

Import individual point-of-interest (POI) lists to your Satellite Navigation System via the myAudi portal



Train information

Find departure and arrival times and platform information while you're on the road. (Also available for other types of public transport such as underground systems)



Country specific information

The legal regulations for a specific country, such as speed limits or whether it is compulsory to carry a high-visibility vest or display a motorway toll sticker, are displayed when crossing a border



Fuel prices

Information on filling stations with the cheapest prices in your selected search area



Parking information

Helps you find car parks nearby and, where available, information on prices and currently vacant spaces



Flight information

Get information about departure and arrival times as well as the corresponding gates and search directly for flight numbers



Access smartphone voice control

Such as Siri (iPhone 4S and higher). By pressing and holding the voice control button on the multifunction leather steering wheel you can access the voice control function of the Bluetooth-connected smartphone directly even while driving



Navigate with Google Earth™ and Google Street View™

Uses high-resolution aerial and satellite images as well as photos to guide you to your destination with destination input via myAudi or Google maps



Technology



Technology is advancing at an ever faster pace, and choosing the right technology for your car is an important decision.

Here at Audi, we strive to make that choice as easy as possible, so we have packaged some of our most popular equipment together for simplicity, but also added value. The most popular of which are our Technology package, featuring Audi Connect and our Comfort and Sound package. For further details please see page 52.

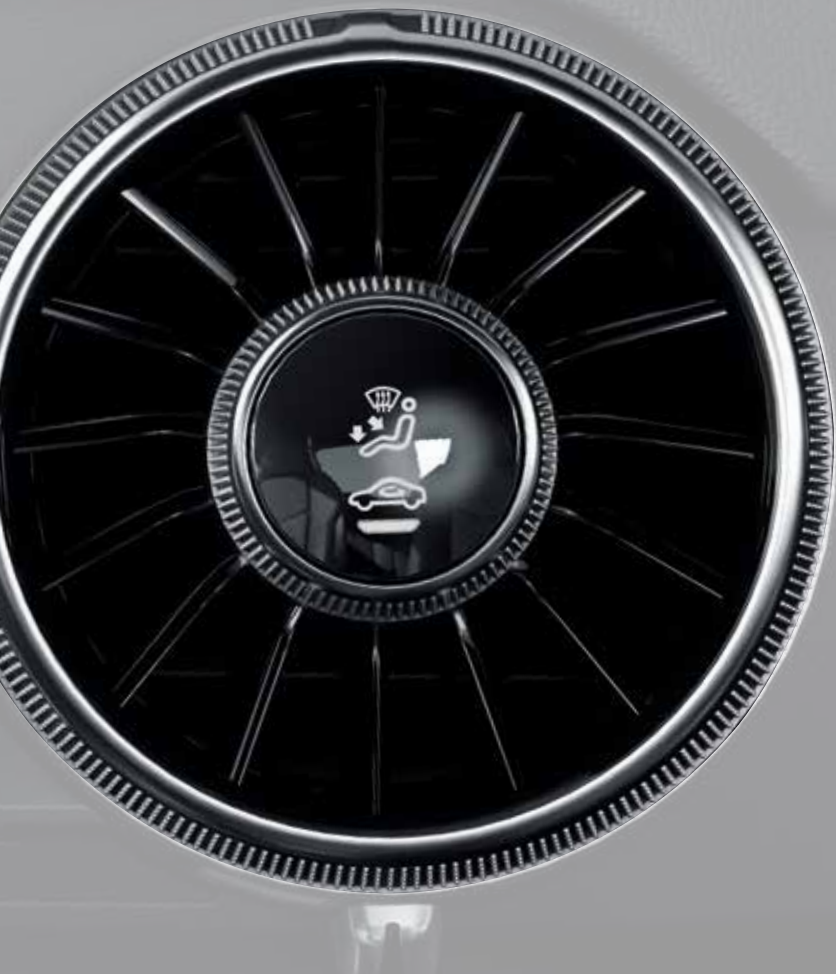

Climate control

Set low and with an arresting turbine-like look, the round air vents exemplify the new TT's leaner interior design. With controls and optional digital displays integrated within the vents, space has been saved on the dash, contributing to a clutter-free look in the cabin. For convenience, adjustment functions for seat heating, temperature, direction and strength are fixed in the vents' axes. Deluxe electronic climate control automatically maintains the air temperature at a desired setting and includes digital displays. This option is available within the Comfort and Sound Package.



MMI Navigation Plus

With MMI Navigation plus, the navigation system is integrated into the stunning 12.3" Audi Virtual Cockpit to offer a 3D map display. It enables you to set your destination by simply by writing characters on the touchpad or by saying a town or street name, so you don't need to divert your eyes from the road.



Bang & Olufsen

An extraordinary car demands an extraordinary sound system. With a 680-watt, 14-channel amplifier and 12 optimally placed loudspeakers, the new Audi TT's Bang & Olufsen system provides just that. When combined with Technology Package, the system delivers high-definition, 5.1 surround sound which, thanks to the standard active VNC (Vehicle Noise Control), is never impaired by internal or external ambient noise.

But it's not just about listening pleasure: every visible part of the system is designed to integrate elegantly into the car's sleek new cabin.

Sport model equipment

All TT Coupé Sport models have the following items of standard equipment

Wheels, tyres and suspension

18" x 8.5J '10-spoke' design alloy wheels with 245/40 R18 tyres

Audi drive select with 4 pre-configured modes – Auto, comfort, dynamic, efficiency and an individual mode, allowing the driver to electronically adjust the engine, transmission and steering. Modes can be selected via a button in the centre console or via the MMI system

Anti-theft wheel bolts

Tyre repair kit

Electromechanical Parking Brake

Progressive steering – High steering precision combined with minimised steering effort thanks to variable steering ratio. Increases the vehicle's agility when cornering and reduces steering work when parking - can be configured via Audi drive select

Start-Stop system with energy recuperation

Audio and communication

Audi Virtual Cockpit – 12.3" high resolution LCD display. The fully digital instrument cluster is customisable by the driver. All the functions and services are depicted using superb graphics with a 3D impression and detailed effects in brilliant clarity

Audi Music Interface – Universal connection for use with stereo audio sources, USB and MP3 devices including Apple iPod generation 4 onwards. The interface provides charging function (dependent on device)

MMI Radio which includes:

- Single CD player and two SDXC memory card readers (MP3, WMA and ACC compatible)
- MMI control panel with MMI touch - a touch sensitive control panel that the user can enter letters and digits on by using fingers
- TP memo, which automatically saves traffic news when driving
- FM and AM (MW) radio reception
- 4 front passive speakers

DAB digital radio

Preparation for Navigation to be fitted – Allows maps to be retro-fitted using parts from Audi Genuine Accessories

Bluetooth Mobile telephone preparation – For hands free mobile phone connectivity and Bluetooth audio streaming (depending on compatibility of mobile phone)



Exterior equipment

Xenon headlights with LED daytime-running lights with automatic headlight range control. Also includes LED rear lights, brake lights and rear indicators

Door mirrors – electrically adjustable and heated with built-in LED side indicators and painted in body colour

Retractable rear spoiler – deploys and retracts automatically at set speed or when the centre console button is pushed

Interior equipment

3-spoke flat bottomed leather-trimmed Sport multi-function steering wheel – Includes speech dialogue system, adjustable in height and distance. With gear shift paddles on S tronic models

Manual Air Conditioning with adjustable controls integrated directly in the air vents

Inlays in aluminium design

Aluminium door sill trims

Non-smoking package – Includes standard 12V socket

Seats

Front Sports Seats with integrated head restraints with manual forward, backwards and backrest angle adjustment (on driver's and front passenger's side)

Alcantara/leather upholstery

- Seat centre panels and door trim inserts in Black Alcantara
- Seat side bolsters and head restraints in black leather

ISOFIX child seat mounting for front passenger seat (with airbag deactivation) and outer rear seats. Including Top Tether attachment point

Split folding rear seat

Safety and security

Front airbags with front passenger deactivation

Front side airbags with head level airbag system

Tool kit, warning triangle and car jack

Keyless go – allows engine to be started by simply pressing the start/stop button in the centre console

Anti theft Alarm

First aid kit

Tyre Pressure loss indicator

Audi Lane Assist (2.0 TFSI only)

Integrated head restraint system increases the protection and reduces the risk of whiplash



Audi Virtual Cockpit

S line model equipment

In addition to Sport model equipment

Basic RRP
£2,125.00

Total RRP inc VAT
£2,550.00

Wheels, tyres and suspension

19" x 9J '5-arm Star' design alloy wheels with 245/35 R19 tyres

Optional S line Sports suspension – lowered by 10mm. Must be ordered using code 1BV at no charge

Exterior equipment

All weather LED headlights. LED technology provides lower energy consumption and enhanced contrast with a colour similar to daylight, for increased safety and good recognition by other road users. Includes all-weather light function to reduce the risk of the driver being dazzled when visibility is poor (in fog, rain or snow). Also includes Headlight cleaning system

LED tail lights including LED Dynamic Rear indicators

S line badges on the front wings

Radiator grille in high-gloss black

S line body styling comprising:

- S line front and rear bumpers
- S line side sills
- S line rear diffuser with platinum grey insert

Interior equipment

S line badge on the steering wheel

Extended aluminium look in the interior with pedals in stainless steel

Inlays in matt-brushed aluminium

Door sill trims with S line logo

Gear lever knob in black perforated leather

Black headlining

Seats

Black Alcantara/leather upholstery with S line embossing and contrasting silver stitching on the upholstery, steering wheel and gear knob gaiter

Electric 4-way Lumbar Support - for front seats

Safety and security

Light and rain sensors – Automatically switches the dipped beam headlights and windscreen wipers on/off depending on the light and rain conditions. Includes coming home/leaving home function which delays the deactivation of the front and rear lights after locking and automatic activation of the lights when unlocking



19" x 9J '5-arm Star' design alloy wheels



LED headlights



Image shows an S line model in Daytona Grey, pearl effect paint with optional 20" x 9J "10- Y-spoke" design alloy wheels (CES)

TT Coupé Sport

Engines	Power	Transmissions	CO ₂ g/km	Basic RRP	Total RRP inc VAT	Recommended OTR
2.0 TFSI	230PS	6-speed manual	137	£24,237.50	£29,085.00	£29,860.00
2.0 TFSI quattro	230PS	6-speed S tronic	149	£26,662.50	£31,995.00	£32,785.00
2.0 TDI ultra	184PS	6-speed manual	110	£24,270.83	£29,125.00	£29,770.00

TT Coupé S line

Engines	Power	Transmissions	CO ₂ g/km	Basic RRP	Total RRP inc VAT	Recommended OTR
2.0 TFSI	230PS	6-speed manual	137	£26,362.50	£31,635.00	£32,410.00
2.0 TFSI quattro	230PS	6-speed S tronic	149	£28,787.50	£34,545.00	£35,335.00
2.0 TDI ultra	184PS	6-speed manual	110	£26,395.83	£31,675.00	£32,320.00

The choice of wheel may affect Fuel consumption figures and CO₂ emissions and corresponding VED amount payable.

Please note: The maximum power output figures are quoted in PS (or Pferdestärke, which is the metric equivalent of brake horsepower). To convert to brake horsepower, divide the PS figure by 1.0139.

Recommended On-The-Road (OTR) retail prices include: delivery charge, half a tank of fuel, number plates at £590.00 (inc. VAT), Road Fund Licence (which may vary depending on model/transmission – see page 73 for details) and first registration fee at £55.00. Vehicle Excise Duty correct at time of going to print, but this may alter to reflect any change in the applicable VED rate.

RRP – Recommended Retail Price. VAT is calculated at 20% but this may alter to reflect any change in the applicable VAT rate.





Paint

We believe that every part of your car should have a personal touch. Which is why you can choose from a wide range of paint colours and finishes, from standard shades to metallic and pearl effects. We can even mix a customised colour for you to create the perfect fit.

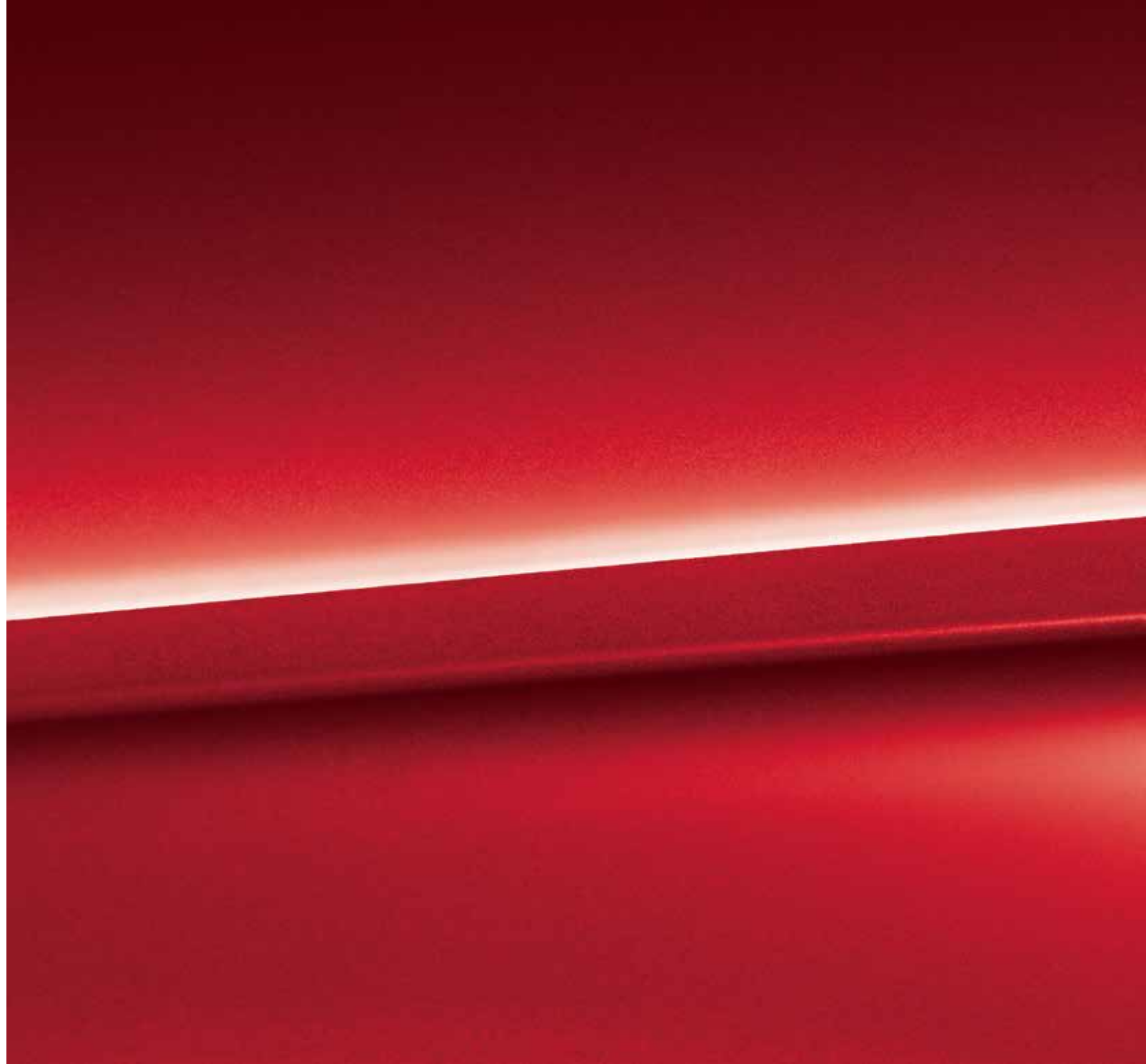

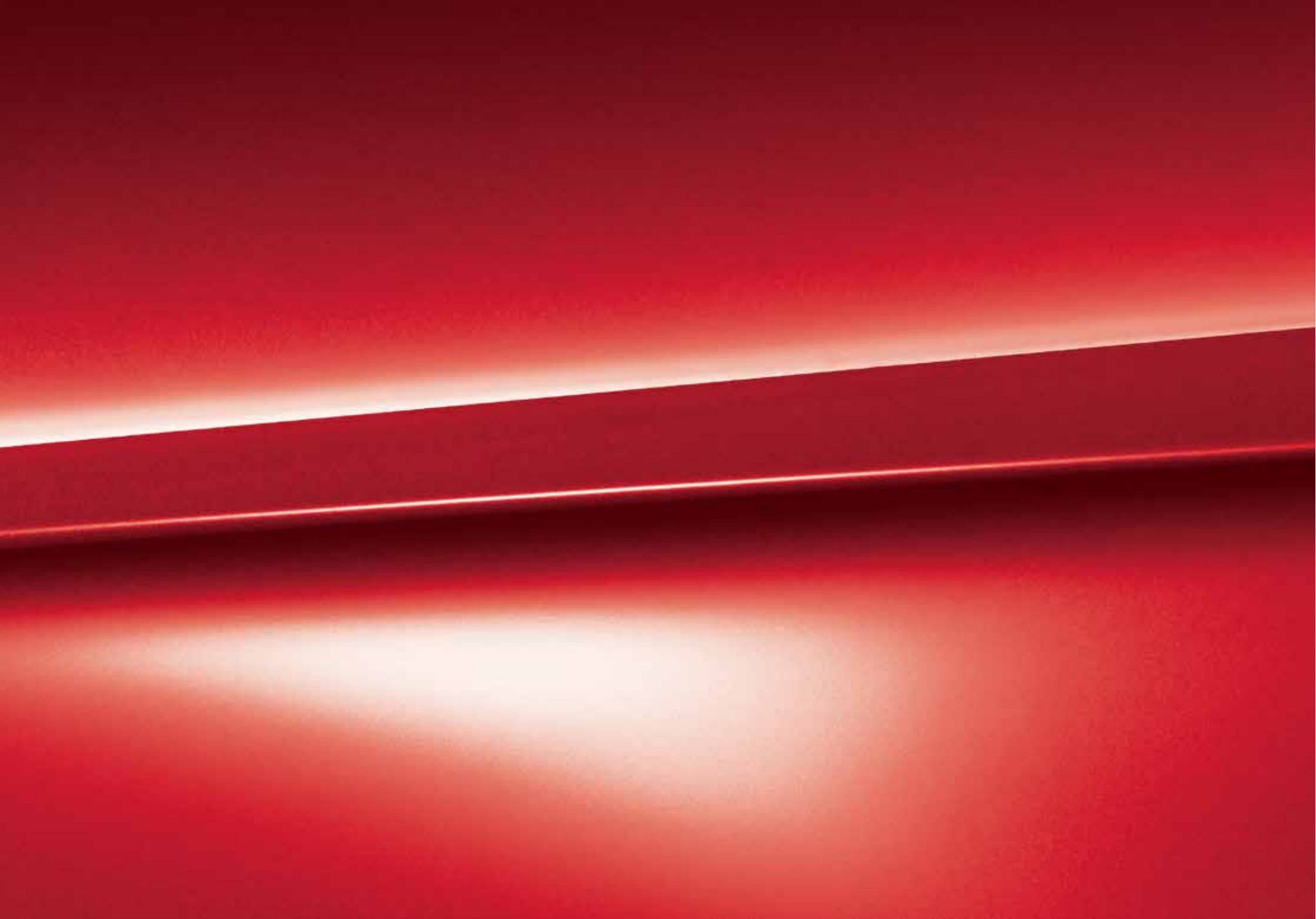

Paint

You can select one of the standard colours shown opposite or, for a different look, choose from the range of metallic or pearl-effect finishes.

Standard colours



Ibis white - T9

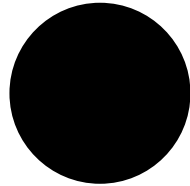

Brilliant black - A2

Optional colours

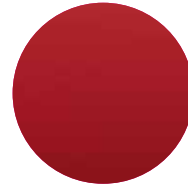

Tango red, metallic - Y1

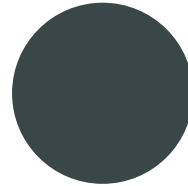

Monsoon grey, metallic - 0C



Glacier white, metallic - 2Y

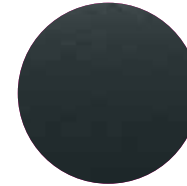

Nano grey, metallic - G3

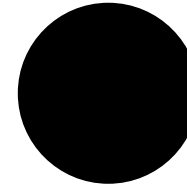

Mythos black, metallic - 0E

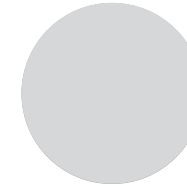

Floret silver, metallic - L5

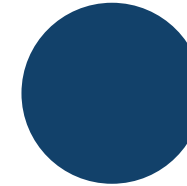

Scuba blue, metallic - S9

S line colour

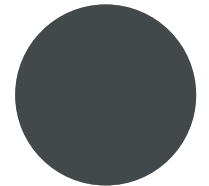

Daytona grey, pearl effect - 6Y

Options are subject to availability and may extend delivery.

All the colour swatches on this page are matched as accurately as possible to the actual paint colours used. However, due to print processes, Audi UK cannot guarantee that colours shown are 100% accurate.

Visit your local Audi Centre for a more accurate colour swatch.

RRP - Recommended Retail Price.

VAT is calculated at 20% but this may alter to reflect any change in the applicable VAT rate.

Optional colours Metallic and Pearl effect

Basic RRP
£454.17

Total RRP inc VAT
£545.00

Paint

Audi exclusive

Everyone has a favourite colour. No matter what yours is, Audi exclusive provides a range of unique colours that have been designed to set your car apart. Choose from the swatches here, or specify any other paint colour in the Audi range.*

Customised

If you have a particular colour in mind, we'll mix the exact metallic or pearl-effect shade you want.**

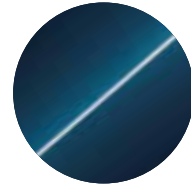

Palace blue, pearl effect

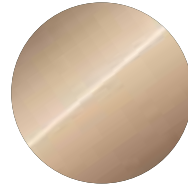

Sand beige, pearl effect

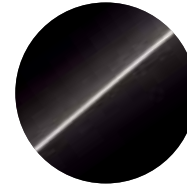

Saddle brown, pearl effect

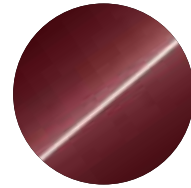

Classic red, pearl effect

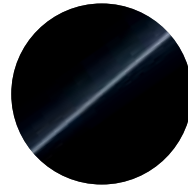

Mamba black, metallic

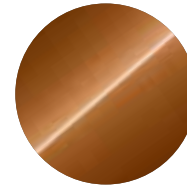

Ipanema brown, metallic



Any colour in the Audi range or 100 exclusive colours to choose from*



Customised paint**

Audi exclusive*

Basic RRP
£1,687.50

Total RRP inc VAT
£2,025.00

Customised**

Basic RRP
£2,104.17

Total RRP inc VAT
£2,525.00

*Audi exclusive paint is subject to factory approval. Visit your local Audi Centre for colour samples.

**Customised paint is subject to factory approval, and is available for metallic and pearl-effect water-based paints only. Three-colour process colours and two-tone schemes are not available.

All the colour swatches on this page are matched as accurately as possible to the actual paint colours used. However, due to print processes, Audi UK cannot guarantee that colours shown are 100% accurate.

Visit your local Audi Centre for a more accurate colour swatch.

RRP – Recommended Retail Price.

VAT is calculated at 20% but this may alter to reflect any change in the applicable VAT rate.

Upholstery





Upholstery

TT Coupé Sport models with Sports seats

Choose your favourite upholstery from the swatches shown opposite to give your car's interior the look and feel you want.

TT Coupé S line models with Sports seats



Options are subject to availability and may extend delivery.

- = Not available
• = Available
S = Standard

RRP – Recommended Retail Price.

VAT is calculated at 20% but this may alter to reflect any change in the applicable VAT rate.

Sports Seats and options

			Sport	S line	Basic RRP	Total RRP inc VAT
Alcantara/leather	 <p>Black – JN/MI</p>	<p>Sports seats in Alcantara/leather. Seat centre sections and door trim inserts in Alcantara. Head restraints, seat side bolsters and front centre armrest (if ordered) in leather</p>	S	–	No charge	No charge
Alcantara/leather	 <p>Black – EI</p>	<p>Sports seats in Alcantara/leather with S line embossing on the front seats. Seat centre sections and door trim inserts in Alcantara. Head restraints, seat side bolsters and front centre armrest (if ordered) in leather</p>	–	S	No charge	No charge
	7P1	Electric lumbar support. For front seats with horizontal and vertical adjustment	•	S	£204.17	£245.00
	4A3	Heated front seats. Individually controlled variable temperature adjustment for driver and front passenger seats	•	•	£270.83	£325.00

Upholstery

TT Coupé Sport models with Super Sport seats

Super Sports seats include integrated head restraints, pronounced side bolsters for improved lateral support when cornering, manual seat adjustment with extendable thigh support and electric lumbar support.

TT Coupé S line models with Super Sport seats







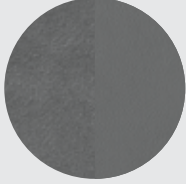

Options are subject to availability and may extend delivery.

- = Not available
• = Available
S = Standard

RRP – Recommended Retail Price.

VAT is calculated at 20% but this may alter to reflect any change in the applicable VAT rate.

Super Sports Seats and options

			Sport	S line	Basic RRP	Total RRP inc VAT
Alcantara/leather	  <p>Black – JN/MI Rock grey – NJ/NI</p>	<p>Super Sports seats in Alcantara/leather. Seat centre sections in Alcantara with diamond quilting. Door trim inserts in Alcantara. Head restraints, seat side bolsters and front centre armrest (if ordered) in leather</p>	•	–	£579.17	£695.00
	   <p>Black – JN/MI Rock grey – NJ/NI Palomino brown – OD</p>		<p>Super sports seats in Fine Nappa leather. Seat centre sections in Fine Nappa leather with diamond quilting. Door trim inserts, head restraints, seat side bolsters and front centre armrest (if ordered) in Fine Nappa leather. Rear seats partly in artificial leather</p>	•	–	£1,158.33
Alcantara/leather	  <p>Black with Rock Grey stitching – EI Rotor grey with Anthracite stitching – OQ</p>	<p>Super sports seats in Fine Nappa leather with S line embossing on the front seats. Seat centre sections in Fine Nappa leather with diamond quilting. Door trim inserts, head restraints, seat side bolsters and front centre armrest (if ordered) in Fine Nappa leather. Rear seats partly in artificial leather</p>	–	•	£579.17	£695.00
	  <p>Black – EI Rock grey – OQ</p>		<p>Super sports seats in Fine Nappa leather with S line embossing on the front seats. Seat centre sections in Fine Nappa leather with diamond quilting. Door trim inserts, head restraints, seat side bolsters and front centre armrest (if ordered) in Fine Nappa leather. Rear seats partly in artificial leather</p>	–	•	£1,158.33
4A3	Heated front seats. Individually controlled variable temperature adjustment for driver and front passenger seats		•	•	£270.83	£325.00
3PK	Electric front seats. Includes adjustment for height, forwards and backwards position and backrest angle. Only in combination with Super Sports seats (PS6)		•	•	£829.17	£995.00

Colour and trim guide

Interior trim colours

Sport models with Sports seats

Order Code	Upholstery	Carpet	Dashboard (upper/lower)	Headlining	Alcantara/leather (N7U)
JN	Black	Black	Black/Black	Black	●
MI	Black	Black	Black/Black	Rock grey	●

S line models with Sports seats

Order Code	Upholstery	Carpet	Dashboard (upper/lower)	Headlining	Alcantara/leather (N7K)
EI	Black	Black	Black/Black	Black	●

Sport models with Super Sports seats

Order Code	Upholstery	Carpet	Dashboard (upper/lower)	Headlining	Alcantara/leather (N7U/PS6)	Fine Nappa leather (N3Q/PS6)
JN	Black	Black	Black/Black	Black	●	●
MI	Black	Black	Black/Black	Rock grey	●	●
NJ	Rock grey	Black	Black/Black	Black	●	●
NI	Rock grey	Black	Black/Black	Rock grey	●	●
OD	Palomino brown	Black	Black/Black	Black	—	●

S line models with Super Sports seats

Order Code	Upholstery	Carpet	Dashboard (upper/lower)	Headlining	Alcantara/leather (N7K/PS6)	Fine Nappa leather (N2R/PS6)
EI	Black with Rock grey stitching	Black	Black/Black	Black	●	●
OQ	Rotor grey with Anthracite stitching	Black	Black/Black	Black	●	●

Options are subject to availability and may extend delivery.

- = Not available
- = Available
- S = Standard



Interior Styling





Inlays

Inlays are the all-important finishing touch that add flair and interest to your car's interior.

Order Code		Sport	Standard	Basic RRP	Total RRP inc VAT
5TH	Aluminium drift silver	S	-	No charge	No charge
5TG	Matt-brushed aluminium	-	S	No charge	No charge

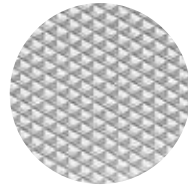

Aluminium drift silver – **5TH**

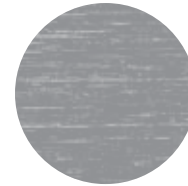

Matt-brushed aluminium – **5TG**

Options are subject to availability and may extend delivery.

- = Not available
- = Available
- S = Standard

RRP – Recommended Retail Price.

VAT is calculated at 20% but this may alter to reflect any change in the applicable VAT rate.

Interior elements

Add some additional personalisation to your TT with our Interior elements options, which complement your interior with your chosen finish on the side of seat, sides of the centre console and air vents.

Order Code		Sport	S line	Basic RRP	Total RRP inc VAT
OUF	Interior elements in Fine Lacquer Bronze. Only in combination with Super Sports seats	●	—	£208.33	£250.00
OUL	Interior elements in Fine Lacquer Metal Grey. Only in combination with Super Sports seats	●	—	£208.33	£250.00
OUI	Interior elements in Quartz Lacquer Anthracite. Only in combination with Super Sports seats	—	●	£208.33	£250.00
OUK	Interior elements in Quartz Lacquer Silver. Only in combination with Super Sports seats	—	●	£208.33	£250.00

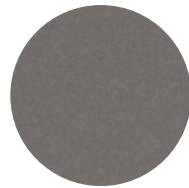

Interior elements in
Fine Lacquer Bronze – **OUF**

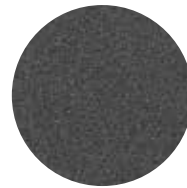

Interior elements in
Fine Lacquer Metal Grey – **OUL**

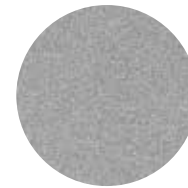

Interior elements in
Quartz Lacquer Anthracite – **OUI**

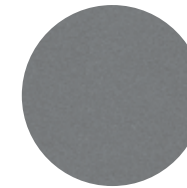

Interior elements in
Quartz Lacquer Silver – **OUK**

Options

Every driver has different needs, which is why we have created some useful options to further enhance your car. For extra comfort, support, style or function, you can choose from a variety of additional features, tailoring everything from your infotainment and audio equipment to your wheels and lighting.





Wheels, tyres and suspension

Choose a set of specially selected alloy wheels to subtly enhance the way your car looks.



18" x 8.5J '10-spoke'
design alloy wheels - CV8



18" x 8.5J '20-spoke-V'
design alloy wheels - C3A



18" x 8.5J '5-twin-spoke Dynamic'
design alloy wheels - C3G



18" x 8.5J '10-V-spoke'
design alloy wheels - C6C



19" x 9J '5-Arm Star'
design alloy wheels - CJ3



19" x 9J '5-twin-spoke'
design alloy wheels - C5K



20" x 9J '10-Y-spoke'
design alloy wheels - CE5*

*This wheel will affect the fuel consumption figures and the CO₂ emissions. This may result in an increase in subsequent Vehicle Excise Duty payable. Please see page 70 for details.

Wheels, tyres and suspension

Order Code		Sport	S line	Basic RRP	Total RRP inc VAT
CV8	18" x 8.5J '10-spoke' design alloy wheels with 245/40 R18 tyres	S	—	No charge	No charge
C3A	18" x 8.5J '20-spoke-V' design alloy wheels with 245/40 R18 tyres	●	—	No charge	No charge
C3G	18" x 8.5J '5-twin-spoke Dynamic' design alloy wheels with 245/40 R18 tyres	●	—	£375.00	£450.00
C6C	18" x 8.5J '10-V-spoke' design alloy wheels with 245/40 R18 tyres	—	●	No charge	No charge
CJ3	19" x 9J '5-Arm Star' design alloy wheels with 245/35 R19 tyres	—	S	No charge	No charge
C5K	19" x 9J '5-twin-spoke' design alloy wheels with 245/35 R19 tyres	—	●	£375.00	£450.00
CE5	20" x 9J '10- Y-spoke' design alloy wheels with 255/30 R20 tyres*	—	●	£708.33	£850.00
1BV	S line suspension lowered by 10mm	—	●	No charge	No charge

Options are subject to availability and may extend delivery.

*This wheel will affect the fuel consumption figures and the CO₂ emissions. This may result in an increase in subsequent Vehicle Excise Duty payable. Please see page 70 for details.

— = Not available
● = Available
S = Standard

RRP – Recommended Retail Price.

VAT is calculated at 20% but this may alter to reflect any change in the applicable VAT rate.



Packages

Some items work well together, which is why we've created these special packages. They provide increased convenience and value by combining several of our most popular options.

Options are subject to availability and may extend delivery.

- = Not available
- = Available
- S = Standard

RRP – Recommended Retail Price.

VAT is calculated at 20% but this may alter to reflect any change in the applicable VAT rate.

Order Code	Sport	S line	Basic RRP	Total RRP inc VAT
<p>WB4</p> <p>Technology Package featuring Audi Connect. Utilise the stunning graphics of Audi Virtual Cockpit with 3D navigation and the addition of Audi Connect to offer internet access on the move. Includes:</p> <p>MMI Navigation Plus, highlights include: Navigation system integrated into the stunning 12.3" Audi Virtual Cockpit to offer 3D map display, map update service for the first five half yearly navigation updates, 8 passive loudspeakers, total power of 100 watts, Media jukebox with space for approximately 10GB and album cover display, DVD drive (MP3, WMA, AAC and MPEG-4-compatible) for music CDs and video DVDs, Whole word address input in one sentence using voice control system and MMI Search: Free text search with intelligent suggestions during input</p> <p>Audi Connect. Convenient connection of your vehicle to the internet via an integrated data module with LTE/ UMTS connection Highlights of Audi Connect services include navigation with Google Earth™ and Google Street View™, destination input via myAudi or Google Maps™, access to Facebook and Twitter, Wi-Fi hotspot, weather and news online and travel information Please see pages 24 & 73 for a full description of this option including functionality and compatibility details</p> <p>Important Connectivity Information. An external data source is required to enable the Audi Connect Online Services. A separate SIM card can be inserted in the SIM card reader</p>	•	•	£1,495.83	£1,795.00
<p>WB3 9VS</p> <p>Comfort and Sound package. Combines the ultimate in sound quality together with everyday comfort items Includes:</p> <p>Bang & Olufsen Sound System. Features 12 high-performance speakers, a 14-channel amplifier with a total power of 680 watts. The system is equipped with VNC (Vehicle Noise Compensation), which, through the on-board microphone detects the sound reproduced and enable compensation for external and internal noise. When combined with Technology Package 5.1 surround sound is achieved</p> <p>Deluxe Automatic Air Conditioning with integrated digital displays. Features digital integrated displays directly in the air vents and electronically regulates the air temperature, air flow rate and air distribution. Automatic recirculation mode by means of air quality sensor, combined filter, and humidity regulation for more efficient climate control</p> <p>Audi Parking System, rear. Makes reverse parking easier by indicating acoustically how far away the vehicle is from an object detected behind it. Measurement is by ultrasonic sensors integrated discreetly in the bumper</p> <p>Front Centre Armrest with angle and lengthways adjustment. Also includes an additional fold-out cupholder</p>	•	•	£1,325.00	£1,590.00



MMI Navigation Plus - Part of the Technology Package



Electronic Climate Controls - Part of the Comfort and Sound Package



Bang & Olufsen - Part of the Comfort and Sound Package



Image shown also features aluminium foot rest. On UK models this will be black.

Audio and communication

Stay in touch using our range of communication functions, and give each journey its own soundtrack with our advanced audio equipment.

Order Code		Sport	S line	Basic RRP	Total RRP inc VAT
9VD	Audi sound system. Audi sound system ensures perfectly balanced sound throughout the entire passenger compartment: - 9 speakers in total including centre speaker and two bass speakers in the doors - 5-channel amplifier with a total output of 155 watts	●	●	£225.00	£270.00
9ZE	Audi Phone Box. Allows telephone calls to be made in the vehicle by placing the mobile phone in the Centre console compartment that is designed for this purpose: - Contains a hands-free system and voice control for the telephone functions - Includes connection to the vehicles aerial via intergrated coupling, hence lower SAR radiation in the vehicle interior - Charging option via USB connection - Operation is via the MMI control unit, the multi-function steering wheel or voice command	●	●	£270.83	£325.00

Interior equipment

Specify every detail of your car's interior with this range of exclusive options.

Order Code		Sport	S line	Basic RRP	Total RRP inc VAT
6E3	Front centre amrest	●	●	£145.83	£175.00
QE1	Storage and luggage package provides additional space for storage, including: - Storage nets on the backs of the front seat back rests - Storage net in the front passenger footwell - Storage under the front seats containing 2 safety vests - A 12V socket and additional LED lighting in the luggage compartment	●	●	£145.83	£175.00
PU7	Auto-dimming rear-view mirror with light and rain sensor package. includes: - A light sensor which detects when the headlights behind are too bright and dims the rear-view mirror automatically - Automatically switches the dipped beam headlights and windscreen wipers on/off depending on the light and rain conditions - Coming home/leaving home function which delays the deactivation of the front and rear lights after locking and automatic activation of the lights when unlocking	●	—	£220.83	£265.00
QJ1	LED interior lighting package, in addition to the standard interior lighting: - Anti-glare lighting for the passenger compartment comprising door sill and footwell lighting at the front - Illuminated inside door openers - Active door reflectors	—	●	£91.67	£110.00
QJ1	LED interior lighting package, in addition to the standard interior lighting: - Anti-glare lighting for the passenger compartment comprising door sill and footwell lighting at the front - Illuminated inside door openers - Active door reflectors	●	●	£225.00	£270.00
PG3	Advanced key. Access and authorisation system which automatically exchanges data between key and vehicle, allowing the driver to keep the key in their pocket or bag at all times. To unlock and open, simply lift the exterior door handle. To lock, press the button on the handle	●	●	£379.17	£455.00
9JD	Smoking package with cigarette lighter and 12V socket in the centre console	●	●	£25.00	£30.00

Options are subject to availability and may extend delivery.

- = Not available
- = Available
- S = Standard

RRP – Recommended Retail Price.

VAT is calculated at 20% but this may alter to reflect any change in the applicable VAT rate.







Exterior equipment

Make sure your car looks exactly as you want it to by selecting some of our striking options.

Order Code		Sport	S line	Basic RRP	Total RRP inc VAT
PX2 PU7	LED headlights. All-weather LED headlights LEDs for all front lighting functions. LED technology provides lower energy consumption and enhanced contrast with a colour similar to daylight, for increased safety and good recognition by other roads. Includes all-weather light function to reduce the risk of the driver being dazzled when visibility is poor (in fog, rain or snow). Also includes Light and Rain Sensors (PU7) and includes LED tail lights with dynamic flashing rear indicators and headlight cleaning system	●	S	£1,412.50	£1,695.00
8G1	High-beam assist. Working within system limits, automatically detects the headlights of oncoming traffic, the rear lights of other road users and built-up areas and depending on the traffic situation, the high beam is automatically switched on or off. Only in combination with Auto-dimming rear-view mirror with light and rain sensor package (PU7)	●	●	£133.33	£160.00
PXC PU7	Audi Matrix LED Headlights. Audi Matrix technology provides maximum and precise illumination at all times without dazzling other road users, and minimum energy required. The Matrix LED units each incorporate 12 separate controllable LEDs which form the high beam and can be individually shut off when sensors detect traffic ahead or approaching to 'divert' the beam around other road users without diminishing its effectiveness. The vehicle uses information from a camera to detect other road users to identify the appropriate lighting required. Also includes: - Dynamic front and rear indicators which sweep from inside out - Headlight cleaning system (8X1) - Light and rain sensors with auto dimming rear view mirror (PU7)	●	—	£1,979.17	£2,375.00
		—	●	£787.50	£945.00
VW1	Privacy glass. Dark tinted rear and rear-side windows from B-pillar backwards	●	●	£375.00	£450.00
6XE	Door mirrors – Electrically adjustable, folding and heated. Also includes an automatic kerb view dipping function on the passenger side when reverse gear is selected	●	●	£179.17	£215.00
6XK	Door mirrors – Auto-dimming on the driver's side, electrically adjustable, folding and heated. Also includes an automatic kerb view dipping function on the passenger side when reverse gear is selected. Only in combination with auto-dimming rear-view mirror (PU7)	●	●	£233.33	£280.00
2Z0	Deletion of model and technology designation	●	●	No charge	No charge

Options are subject to availability and may extend delivery.

- = Not available
- = Available
- S = Standard

RRP – Recommended Retail Price.

VAT is calculated at 20% but this may alter to reflect any change in the applicable VAT rate.

Safety and security

Intelligent technology designed to give you better all-round awareness and safety on the road.

The drivers assistance systems featured on these pages work only within system limits. They assist the driver with driving tasks. However, the driver remains responsible for driving the vehicle and is required to be attentive.

Options are subject to availability and may extend delivery.

- = Not available
• = Available
S = Standard

RRP – Recommended Retail Price.

VAT is calculated at 20% but this may alter to reflect any change in the applicable VAT rate.

Order Code		Sport	S line	Basic RRP	Total RRP inc VAT
UH2	Hold assist	•	•	£75.00	£90.00
7X1	Audi parking system, rear (also available as part of the Comfort and Sound package). The system warns the driver about obstacles with a warning tone which gets progressively faster as the vehicle moves closer to the obstacle	•	•	£358.33	£430.00
7X2	Audi parking system plus, front and rear with selective display. In addition to Audi parking system rear, also includes: - - Selectable sensors and detection systems for the front of the vehicle - A visual display in the virtual cockpit which shows the parking situation around the vehicle which displays white distance markers for obstacles that would not be touched and red symbols for obstacles that may be touched	•	•	£700.00	£840.00
	In combination with Comfort and Sound package	•	•	£341.67	£410.00
7X5	Audi parking system plus, with park assist. In addition to parking system plus front and rear with selected display: - - Ultrasonic sensors are used to search for parking spaces by the roadside and the system calculates the ideal parking path for reverse and parallel parking spaces - The steering action is performed almost automatically - Assisted parking is now even possible in smaller parking spaces and bend areas, and the system will park the car in several moves if required - Steering is done by the vehicle, while the driver only needs to accelerate and apply the brakes - Additional sensors indicate obstacles detected all around and at the side of the vehicle, and warn the driver, making parking easier and safer by setting the correct steering angle	•	•	£891.67	£1,070.00
	In combination with Comfort and Sound package	•	•	£533.33	£640.00
8T6	Cruise control. Maintains any speed above 18mph, provided that the engine power output and engine braking effect permit it. Operated via separate steering column stalk, with set speed displayed in the virtual cockpit	•	•	£245.83	£295.00
6I1	Audi active lane assist. Helps the driver stay in lane by gentle steering intervention, thereby providing enhanced safety and comfort, especially on motorways and country roads: - - Working within the system limits, it functions between speeds of approx 37 mph to 155 mph and detects lane markings - It then helps the driver remain in lane by active steering intervention and, if desired, vibration when inadvertently leaving the lane without indicating - The system is activated manually by a switch indicator stalk (Standard on the 2.0 TFSI engines) Only in combination with Auto-dimming rear-view mirror with light and rain sensor package (PU7) on the 2.0 TDI engine on Sport trim	•	•	£541.67	£650.00
7Y1	Audi side assist. Increased safety thanks to monitoring of the blind spot: - - Working within the system limits, it functions above 19 mph using radar sensors to monitor the areas to the side behind the vehicle - It then informs the driver with a visual warning signal in the door mirror if there is a vehicle in their blind spot or approaching quickly from behind - The system is activated using the MMI car settings	•	•	£495.83	£595.00
QR9	Speed limit display. Camera-based detection and display of speed limits, including temporary speed limit displays. Speed limit signs are recognised by the camera and this enables the current speed limit to be read conveniently in the Driver's Information System (DIS). Should the camera not detect a sign, the speed limit from the navigation system data (if fitted) will be shown. Only available as a no-cost option when Technology package (WB4) and Audi active lane assist (7Y4) are ordered together	•	•	£133.33	£160.00





Looking after your Audi

When you've chosen your ideal model, it's reassuring to know that it will remain in safe hands. That's why we've created products to protect your Audi such as extended warranties. And there's also a range of Audi accessories and merchandise to choose from, enabling you to further enhance and safeguard your car.





Warranty

All new Audi models now come with a choice of a three, four or five-year warranty.* What's more, if you decide to sell your Audi before the warranty expires, it will be fully transferred to the new owner. So, whichever length of warranty you choose, you can forget about unexpected repair bills and enjoy several years of carefree driving.

Options are subject to availability and may extend delivery.

- = Not available
- = Available
- S = Standard

*Three year warranty consists of a two-year unlimited mileage warranty and a third year warranty with a 60,000 mile limitation. Four year warranty consists of two-years' unlimited mileage coverage, and two further years' coverage with a 75,000 mile limitation. Five year warranty consists of two-years' unlimited mileage coverage, and three further years' coverage with a 90,000 mile limitation.

**Only available prior to registration of your Audi TT Coupé. Please speak to your Audi Centre for full details.

RRP – Recommended Retail Price.

VAT is calculated at 20% but this may alter to reflect any change in the applicable VAT rate.

Order Code		TT Coupé	Basic RRP	Total RRP inc VAT
-	Audi Warranty , covering you for unlimited mileage in the first two years of ownership, and up to 60,000 miles in the third year. Transferable between owners**	S	No charge	No charge
EA6	Audi Warranty , covering you for up to 4 years or 75,000 miles, whichever comes sooner. Cover includes a two-year unlimited mileage warranty, and up to 75,000 miles in the third and fourth years. Transferable between owners**	•	£320.83	£385.00
EA9	Audi Warranty , covering you for up to 5 years or 90,000 miles, whichever comes sooner. Cover includes a two-year unlimited mileage warranty, and up to 90,000 miles in the third, fourth and fifth years. Transferable between owners**	•	£754.17	£905.00



Accessories

Choosing an Audi isn't just a matter of deciding on the model you want; it's about creating a car that suits your needs perfectly. And that's why we've developed a range of accessories to enhance your TT Coupé, enabling you to customise it down to the last detail. Like your Audi, all these accessories are developed to the highest possible standards. They're all available exclusively from Audi. To find out more, just visit audi.co.uk/accessories or contact your local Audi Centre.

Warranty

All of the accessories available on the TT Coupé are covered by a three-year warranty* if they are ordered and included in the purchase price of the car at date of delivery. Any accessories ordered and installed after delivery include a two-year warranty.*

*Excluding Road Angel products.

Audi Accessories warranty terms and conditions can be found at audi.co.uk



Merchandise

From the enthusiasts' motorsport collection to the sophisticated Audi collection, there's a wide variety of adults' and children's clothing, lifestyle accessories and collectables, all of which bear the Audi name.

Please speak to a member of our team at your local Audi Centre to see the full Audi collection and to place an order. A selection of Audi merchandise is also available to buy from audi.co.uk/merchandise



The Audi Difference

The experts in Vorsprung durch Technik

Our Audi Approved Master Technicians have undergone an impressive 100,000 hours of training over a 10-year programme to ensure they have the latest technical expertise for maintaining and servicing your Audi. All our Service Advisors undergo a specialist induction and training to ensure they are Audi professionals and able to talk to you about any issues you may have with your Audi vehicle.

Servicing tailored to your needs

Regular servicing is key to safeguarding your Audi's performance and a full Audi service history could help you enhance the future re-sale value. To make servicing easy, the Audi Service Schedules have been designed to work with your individual driving style and vehicle.

We offer two different schedules: the fixed Inspection Service and the Flexible Service schedule. The conventional fixed Inspection Service schedule has fixed intervals for the Oil-change Service and Inspection Service, which are determined by time and distance.

With the Flexible Service schedule, the Inspection Service intervals are also fixed but the Oil-change Service intervals are variable. Sensors take account of driving style and conditions to determine when the Oil-change Service is required and the driver is informed via the on-board service interval display.

The choice of Service Schedule will depend on journey type and mileage as well as individual driving style and conditions. The table to the right can be used for guidance but your Audi Centre will help you to determine the most suitable Service Schedule for you based on your individual circumstances and preferences.

Fixed Inspection Service Schedule

	Vehicle usage:
Mileage	Less than 10,000 miles per annum Mainly city/town centre driving. Short journeys.
	Service intervals:
Oil-change Service	Fixed to every 9,000+ miles/1 year
Inspection Service	Fixed to every 19,000+ miles/2 years

Flexible Service Schedule

	Vehicle usage:
Mileage	More than 10,000 miles per annum Motorway and main road driving. Mainly longer distance journeys. Constant speeds.
	Service intervals:
Oil-change Service	Variable to a maximum of every 19,000+ miles/2 years
Inspection Service	Fixed to every 19,000+ miles/2 years

When a vehicle is frequently used in the following conditions, we recommend a Fixed Inspection Service Schedule, regardless of mileage:

Uneconomical driving styles, e.g. heavy acceleration and braking, constant use of high revs
High engine-loading conditions, e.g. frequent towing and hill climbs

*As indicated by the service interval display. Mileages are approximate as the Service Indicator system uses kilometres as its distance measurement.

Your convenience comes first

At Audi you can choose from a range of convenient services that suit your needs. Why not book a 'service while you wait' appointment* and enjoy our complimentary refreshments while your car is with us? Or, if you need to be mobile, take advantage of one of our courtesy cars which we can even deliver to you.* We guarantee we can service your Audi within 5 days without a courtesy car or within 10 days if you need transport. We will also ensure your car is returned to you with a full valet.

Audi Genuine Parts

You can rest assured that only Audi Genuine Parts will be used on your vehicle. What's more, Audi parts and labour come with a 2-year guarantee.**

No hidden costs

We believe strongly in transparency when it comes to our prices. For added peace of mind, we will give you a quotation over the phone for the work you have requested and email you the price confirmation. We'll consult you if any additional work on your car is needed when it is with us. We won't carry out any extra work without asking your permission first.

All part of the service

Whenever we see an Audi for a service, we connect it directly to our headquarters in Ingolstadt which enables us to check your car's software and make sure it's as up-to-date as possible. If the factory has released a software upgrade for your model, it can be applied immediately - improving anything from your car's efficiency to the precision of its parking system.

Audi Roadside Assistance

Your new car comes complete with 3 years' complimentary roadside assistance and recovery across the UK, provided by Automobile Association Insurance Services Limited. Also included is roadside assistance throughout Europe, managed by Automobile Association Insurance Services Limited.

For further information and terms and conditions please visit audi.co.uk

*Subject to availability.

**Excludes wear and tear.





TT Coupé

technical data

*Optional 20" wheels may affect the fuel consumption figures, the CO₂ emissions and BIK. This may result in an increase in subsequent Vehicle Excise Duty payable. See page 73 for more details on VED rates.

[†]Highest insurance group rating shown. Group may be lower dependent on trim level. Please visit www.thatcham.org/abigrouprating for details.

Please note: The maximum power output figures are quoted in PS (or Pferdestärke, which is the metric equivalent of brake horsepower). To convert to brake horsepower, divide the PS figure by 1.0139.

[‡]The given value was obtained in accordance with the specified measurement procedure (the respective current version of the Directive 80/1269/EEC).

[§]Top speed is achieved in top gear.

[¶]Fuel consumption and CO₂ emissions figures are obtained under standardised test conditions (Directive 93/116/EEC) using a representative model. This allows direct comparison between different models from different manufacturers, but may not represent the actual fuel consumption achieved in 'real world' driving conditions. More information is available at www.vca.gov.uk

^{||}Vehicle's unladen weight without driver (calculated in accordance with the current version of Directive 80/1268/EEC). The fitting of additional equipment may increase the vehicle's unladen weight and drag coefficient, whereupon the potential carrying capacity and top speed will be correspondingly reduced.

^{|||}The engine's power output always goes down with increasing altitude. At 1,000m above sea level, and for every additional 1,000m, deduct 10% from the weight of the outfit (trailer load limit + gross weight of the towing vehicle).

Engine	Petrol		Diesel
	2.0 TFSI	2.0 TFSI quattro	2.0 TDI ultra
Transmission	6-speed manual	6-speed S tronic	6-speed manual
Cylinder	4-cylinder	4-cylinder	4-cylinder
Displacement, cubic cm (valves per cylinder)	1984 (4)	1984 (4)	1968 (4)
Max. power [‡] , PS at rpm	230/4500-6200	230/4500-6200	184/3500-4000
Max. torque, Nm at rpm	370/1600-4300	370/1600-4300	380/1750-3250
Top speed [§] , mph	155	155	150
0-62mph acceleration, seconds	6.0	5.3	7.1
CO ₂ emissions [¶] , g/km*	137	149	110
with 20" optional wheels	139	151	114
Benefit in kind (BIK)%	20%	22%	18%
with 20" optional wheels	N/A	23%	N/A
Fuel consumption , mpg (l/100km) Urban*	38.7 (7.3)	34.0 (8.3)	57.6 (4.9)
with 20" optional wheels	38.2 (7.4)	33.6 (8.4)	55.4 (5.1)
Fuel consumption , mpg (l/100km) Extra Urban*	56.5 (5.0)	52.3 (5.4)	76.3 (3.7)
with 20" optional wheels	55.4 (5.1)	51.4 (5.5)	72.4 (3.9)
Fuel consumption , mpg (l/100km) Combined*	47.9 (5.9)	44.1 (6.4)	67.3 (4.2)
with 20" optional wheels	47.1 (6.0)	43.5 (6.5)	64.2 (4.4)
ABI insurance group 1-50 [†]	TBC	TBC	TBC
Unladen weight , kg	1230	1335	1265
Gross weight limit, kg	1630	1735	1665
Roof load limit	75	75	75
Luggage compartment capacity, rear seats upright, litres	305	305	305
Luggage compartment capacity, rear seats folded, litres	712	712	712
Fuel tank capacity approx, litres	50	55	50
Emission standard	EU6	EU6	EU6

TT Coupé dimensions

The technical drawings opposite show the exact dimensions of the new Audi TT Coupé, so you can check everything – from whether the car will fit in your garage to whether your luggage will fit in the boot.

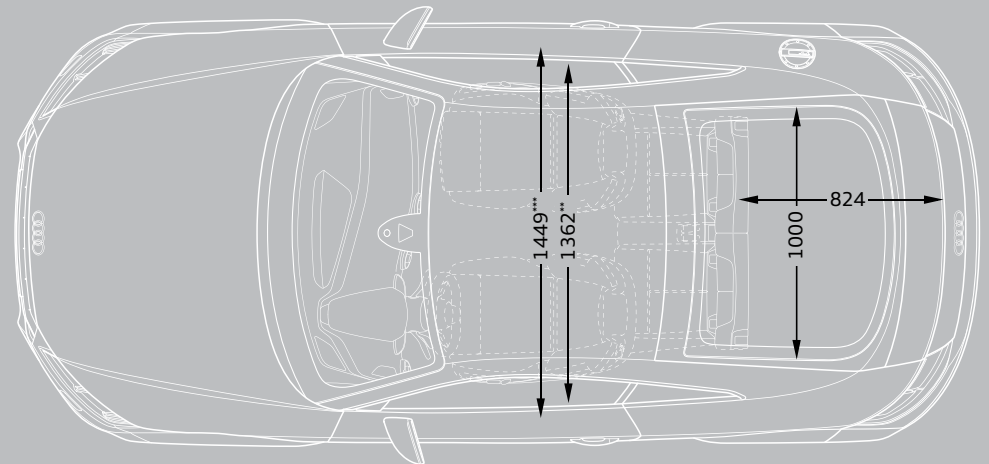
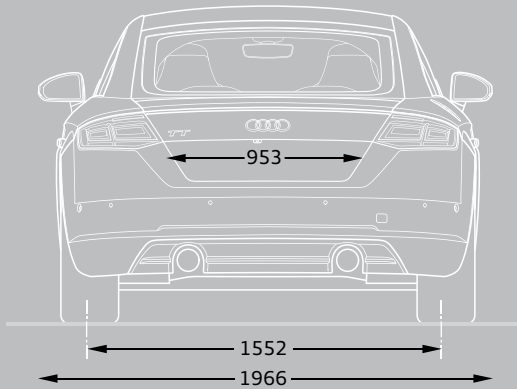
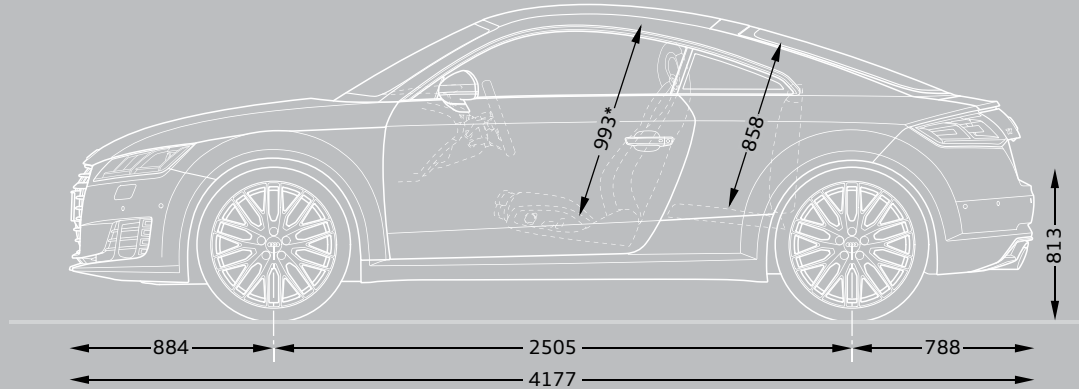
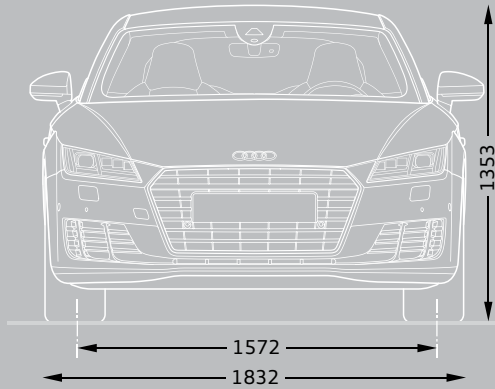

*Maximum headroom.

**Elbow room width.

***Shoulder room width.

Dimensions in millimetres.

Turning circle approx 11m.

Dimensions measured with vehicle at unladen weight.

Pricing and Additional information

Welcome to Audi

By placing an order for your Audi, you're choosing to get behind the wheel of one of the most sophisticated cars on the road. And because we believe the service we offer should be just as advanced, we want to let you know exactly what you can expect from us, now and in the future.

We've agreed a set of standards with all our Centres which governs the way we do business with you. It outlines the kind of service we promise to deliver for every customer, right down to filling each new Audi we sell with half a tank of fuel.

So whether you're interested in the date your car will arrive in the UK or the way we'll dispose of non-biodegradable materials after we service your Audi, you can have total confidence in us.

Audi Promise

Audi Centres

We guarantee that all our Centres will be open as follows:

Sales: Monday to Friday 9am–6pm
Saturday 9am–5pm

Service: Monday to Friday 8am–6pm
Saturday 8.30am–1pm

Sunday opening is at local discretion.

New car delivery

Once we've confirmed a delivery date for your car, we'll keep you informed of progress. Subject to reasonable notice, we'll then deliver it to a place of your choice, whether that's your home or work. In the unlikely event of a delay, we'll provide a courtesy car to minimise inconvenience and keep you mobile.

Environmental commitment

We promise to dispose of all non-biodegradable materials from your vehicle in a responsible manner.

Pricing

Prices and specifications given are correct at the time of printing. Always check details with your Audi Centre as Audi policies are continually developing. We reserve the right to change prices or specifications at any time.

All prices are subject to VAT, currently charged at 20%, but this may alter to reflect any change in the applicable VAT rate.

Delivery charges and number plates are not included in the vehicle price.

Delivery charge	£471.66
Number plate	£20.00
VAT	£98.34
Total	£590.00

Audi Customer Care

Every new Audi benefits from the comprehensive Audi Customer Care Package, which comprises:

- ▶ A 3-year Audi warranty, which covers you for unlimited mileage in the first 2 years of ownership, with a full mechanical and electrical warranty which covers you for up to 60,000 miles in the 3rd year
- ▶ A 3-year paint warranty
- ▶ A 12-year anti-corrosion warranty
- ▶ 3 years' UK roadside assistance and recovery

You also have the option when ordering your new car of choosing a 4-year or 5-year Audi warranty. Speak to a member of the sales team for more information.

Audi tax-free sales

If you are entitled to purchase a vehicle free of VAT, normally through military or diplomatic privilege, please contact your local Audi Centre for full details.

Should you have any difficulty obtaining the information you require, please call 01908 548 356.

Audi Finance

Audi Finance specialises in providing funding solutions for Audi drivers. Whether your Audi is for private or business use, there is a range of funding options to choose from.

Below is the full range of finance products, which comprises:

- ▶ Solutions – a Personal Contract Plan
- ▶ Hire purchase
- ▶ Lease purchase
- ▶ Finance lease
- ▶ Contract hire

With all products, you can choose a fixed-cost maintenance plan designed to help you budget accurately.

No matter which Audi model you choose, your local Audi Centre can provide you with a personalised quote designed to fit your budget and motoring needs.

Audi Finance is a trading name of Volkswagen Financial Services (UK) Limited. An offer of finance depends on certain conditions. Available to people over 18 in the UK only.

Audi Insurance

We want you to start enjoying your new car from day one and thanks to Audi Insurance complimentary 7-day cover, you can. Call free on 0800 316 7893 (lines are open Monday to Friday 8am–9pm, and Saturday 9am–5pm), provide a few details and a cover note will be sent to your Audi Centre. They will then tax your car and you can drive it away.

Additional information

CO₂ data and information

CO₂ emissions-based Vehicle Excise Duty

Vehicle Excise Duty (Road Fund Licence) is based upon the amount of Carbon Dioxide (CO₂) a vehicle emits, measured in grams per kilometre (g/km).

First year VED rates apply to the first year of ownership. Annual VED rates apply thereafter. The DVLA has created thirteen categories:

Petrol and Diesel engines	First year	Annual rate (second year onwards)
A – up to 100g/km	£0.00	£0.00
B – 101 to 110g/km	£0.00	£20.00
C – 111 to 120g/km	£0.00	£30.00
D – 121 to 130g/km	£0.00	£110.00
E – 131 to 140g/km	£130.00	£130.00
F – 141 to 150g/km	£145.00	£145.00
G – 151 to 165g/km	£180.00	£180.00
H – 166 to 175g/km	£290.00	£205.00
I – 176 to 185g/km	£345.00	£225.00
J – 186 to 200g/km	£485.00	£265.00
K – 201 to 225g/km	£635.00	£285.00
L – 226 to 255g/km	£860.00	£485.00
M – over 255g/km	£1,090.00	£500.00

Vehicle Excise Duty (VED) rates correct at time of going to print, but these may alter to reflect any change in the applicable VED rate.

Audi Connect

An external data source is required to enable Audi Connect online services. One of the two can be used:

1. A mobile telephone with Bluetooth SIM Access Profile – to check the compatibility of your mobile phone and whether it has SIM Access Profile compatibility, please visit <http://www.audi.co.uk/owners-area/get-to-know-your-audi/communication-services.html>
2. A separate SIM card which can be inserted in the included SIM card reader. When a separate SIM card is used, hands free phone calls are possible using the SIM card or by connecting a different mobile telephone via Bluetooth Hands Free Profile

Online services are only available for mobile phone contracts or SIM cards which include a data option with the use of LTE if LTE usage is required. Online services will only be available within the coverage of the mobile phone network; there may be additional costs for the use of these services (charges and billing correspond to the personal mobile phone contract or SIM card contract). Due to high data volumes, a mobile phone contract including an unlimited or high usage data plan is strongly recommended. The content and scope of the online based services offered may vary.

The Audi Connect services are provided for at least one year from vehicle delivery available. After 24 months from delivery of the vehicle, the term of the Audi Connect services will be extended free of charge once for 12 months.

Audi Connect enables access to the services of Facebook, Google and Twitter. Permanent availability cannot be guaranteed as this is the responsibility of Facebook, Google and Twitter.

Please note that the services received are also dependent on the capability of your mobile phone.

Google and the Google logo are registered trademarks of Google Inc.

The availability of services supported Audi Connect varies from country to country.

Online Map updates

The map version delivered can be updated with the first 5 updates which are issued at intervals of 6 months. The Current navigation data can be downloaded from the myAudi Platform at www.audi.com/myaudi and installed in the vehicle via SD card. In conjunction with Audi Connect, the update can be carried out online in the vehicle. In addition it is possible to have the new navigation data installed by an Audi partner at extra cost.



Audi UK
Customer Services
Selectapost 29
Sheffield
S97 3FG
0800 699888
audi.co.uk

Specifications and prices subject
to change without notice.

© Audi (UK)

Printed in the UK
Edition 0.3 08/14
2015 model year

Images are for illustrative purposes only.

