

F-TYPE







F-TYPE

It had to be powerful, agile and utterly distinctive. It had to look, feel and drive like a Jaguar. A true Jaguar sports car; the latest in a distinguished bloodline. We couldn't just call it F-TYPE; we had to make it F-TYPE.

F-TYPE is engineered for high performance and instantaneously responsive handling. Powerful, supercharged engines and a lightning-fast gearbox; lightweight aluminium body construction and an obsession with balance and proportion; a superb suspension and a host of advanced driving technologies; peerless design and a driver focussed cockpit.

Together they produce a uniquely connected driving experience, and a sports car that only Jaguar could create - ultra-precise, powerful, sensual and, most of all, alive.

F-TYPE CONVERTIBLE AND COUPÉ
F-TYPE S CONVERTIBLE AND COUPÉ
F-TYPE V8 S CONVERTIBLE
F-TYPE R COUPÉ

VEHICLE SHOWN ON FRONT COVER: F-TYPE R IN POLARIS WHITE WITH OPTIONAL PANORAMIC ROOF,
GYRODYNE DARK GREY AND DIAMOND TURNED ALLOY WHEELS AND BLACK PACK
VEHICLE SHOWN LEFT: F-TYPE V8 S IN SALSA RED
VEHICLE SHOWN ON BACK COVER: F-TYPE IN STRATUS GREY

ONE PHILOSOPHY, SIX LIVES

F-TYPE's technical excellence delivers a breadth of capabilities to suit the road, the conditions and the demands of the driver. Its single engineering philosophy encompasses two bodystyles, Convertible and Coupé, as well as including all six models. While each offers its own distinctive flavour and characteristics, every **F-TYPE** is equally at home on the switchback of a mountain pass, on the highway and in the city.

F-TYPE CONVERTIBLE



3.0 V6 340 Supercharged
Jaguar Performance Braking System
Sports Suspension
Sports Exhaust

VEHICLE SHOWN: F-TYPE IN STRATUS GREY

F-TYPE COUPÉ



3.0 V6 340 Supercharged
Jaguar Performance Braking System
Sports Suspension
Sports Exhaust

VEHICLE SHOWN: F-TYPE IN RHODIUM SILVER

F-TYPE is designed to deliver pure driving pleasure. It combines effortless, exhilarating performance, instant response and precise agile handling, with everyday refinement and usability. **F-TYPE S** adds greater power and an increased range of sophisticated driving technologies. **F-TYPE V8 S** offers exceptional performance and even greater levels of dynamic ability and control. **F-TYPE R** delivers supercar levels of performance combined with advanced dynamic technologies for the ultimate driver focussed experience.

F-TYPE S CONVERTIBLE



3.0 V6 380 Supercharged
Jaguar High Performance Braking System
Sports Suspension with Adaptive Dynamics
Active Sports Exhaust
Limited Slip Differential

VEHICLE SHOWN: F-TYPE S IN LUNAR GREY

F-TYPE S COUPÉ



3.0 V6 380 Supercharged
Jaguar High Performance Braking System
Sports Suspension with Adaptive Dynamics
Active Sports Exhaust
Limited Slip Differential

VEHICLE SHOWN: F-TYPE S IN RHODIUM SILVER



F-TYPE V8 S CONVERTIBLE

5.0 V8 495 Supercharged
Jaguar Super Performance Braking System
Sports Suspension with Adaptive Dynamics
Switchable Active Sports Exhaust
Electronic Active Differential
Quad Exhaust Pipes

VEHICLE SHOWN: F-TYPE V8 S IN SALSA RED



F-TYPE R COUPÉ

5.0 V8 550 Supercharged
Jaguar Super Performance Braking System
Sports Suspension with Adaptive Dynamics
Switchable Active Sports Exhaust
Electronic Active Differential with Torque Vectoring by braking
Quad Exhaust Pipes

VEHICLE SHOWN: F-TYPE R IN STRATUS GREY



START

ENGINE

STOP

SUPERCHARGED ENGINES

Power is delivered from a range of four highly advanced engines - 3.0 V6 340PS, 3.0 V6 380PS, 5.0 V8 495PS and 5.0 V8 550PS. Each features a Roots-type twin vortex supercharger mounted in the "V" of the engine to maintain the powerplants' compact dimensions.

Jaguar is a leader in the field of **supercharged induction technology**. The advantages of supercharging are clear and compelling. It provides a linear delivery of performance, and instant access to high levels of torque at all engine speeds, minimising the gap between the driver's demand for power and the engine's response.

F-TYPE's Sports Exhaust delivers a crisp note from start up, with the promise of performance building to a race-car inspired crescendo at high rpm and during overrun. An **Active Sports Exhaust** is standard on **F-TYPE S** and optional on **F-TYPE**. The system features active bypass valves which open during performance driving to allow exhaust gases to exit more directly for a deep, dramatic sound. **F-TYPE V8 S** and **F-TYPE R** have a **Switchable Active Exhaust** that allows manual control of the system, for even greater driver involvement.

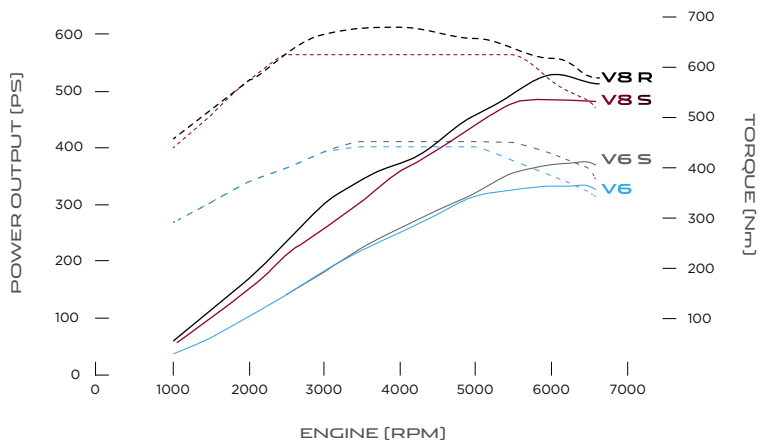

V6

3.0 LITRE 340PS



0-100 KM/H



TOP SPEED KM/H

3.0 LITRE 380PS



0-100 KM/H



TOP SPEED KM/H

Jaguar's new generation, supercharged 3.0 V6 engines are powerful and refined. Generating extremely high specific power outputs of up to 127PS per litre, they deliver thrilling performance and a rewarding driving experience. The compact supercharger's sophisticated boost control and secondary throttle valve ensure that torque curves rise steeply over a broad range of engine speeds. A water-cooled intercooler reduces the temperature of the intake air for greater power and efficiency, while an innovative system of counter-rotating front and rear balancer weights aids smoothness and refinement. They also feature a fast-reacting **Intelligent Stop/Start** system that can improve fuel economy by up to 5 percent.



V8

5.0 LITRE 495PS

5.0 LITRE 550PS



0-100 KM/H



TOP SPEED KM/H



0-100 KM/H



TOP SPEED KM/H



Both 5.0 V8 engines are supremely powerful. A larger supercharger delivers up to 550PS and as much as an astonishing 680Nm of torque. Acceleration is rapid and progressive, response is immediate and predictable. Advanced technologies deliver performance, refinement and efficiency. The lightweight die-cast aluminium blocks are supplemented by cross-bolted main bearing caps to increase rigidity. Valves are controlled by dual independent variable cam timing to optimise power at all engine speeds. Spray-guided direct injection delivers precisely measured quantities of fuel directly into the centre of the combustion chambers at pressures of up to 150bar for cleaner, more efficient combustion. In common with the V6 engines, they also feature an **Intelligent Stop/Start** system that can improve fuel economy by up to 5 percent.



SET +

AS

RES

CAN

MAX

+

QUICKSHIFT TRANSMISSION



**8-SPEED
RATIOS**

**ADAPTIVE
SOFTWARE**

**INSTANTANEOUS
RESPONSE**

F-TYPE's Quickshift automatic transmission is both lightning-fast and superbly refined, offering the benefits of a double clutch transmission and a conventional automatic without the limitations of either. Eight closely-spaced ratios keep the engine within its most effective rev range for longer, providing instantaneous response and outstanding driver feedback, while also optimising the engine for both economy and outright performance.

The transmission control system is intelligent and adaptive. It monitors the driving situation together with the demands the driver is making on the car, and responds to provide a truly dynamic experience. Adaptive software automatically modifies the gear shift strategy, ensuring the right gear is selected for every situation. **Fast Throttle-Off** recognises when the driver is making rapid throttle adjustments, for example during multiple manoeuvres, and automatically holds the gear ratio in anticipation of the next move. **Corner Recognition** senses when the car is in a corner and holds the ratio ensuring the car is in the correct gear when exiting a bend. When decelerating and changing down, the **Speed Matching Management System** matches the engine speed to the gearbox speed, and automatically 'blips' the throttle during downshifts when in Sport Automatic mode, while **Spontaneous Vehicle Deceleration** enables F-TYPE to rapidly downshift under very hard braking conditions.

Dynamic Launch Mode, standard on **F-TYPE S**, applies maximum torque through the gear changes delivering optimum acceleration from rest to 100 km/h. The driver can, of course, take full manual control of the transmission using either gear shift paddles mounted behind the steering wheel, or the joystick-style SportShift gear selector. Once in manual mode, the Quickshift system delivers rapid and precisely timed engine torque interventions, creating shorter and crisper sounding gear shifts.

LIGHTWEIGHT ALUMINIUM CONSTRUCTION



STRONG AND RIGID

HIGH POWER-TO-WEIGHT AND TORQUE-TO-WEIGHT RATIOS



Jaguar has been at the forefront of aluminium car construction for more than a decade and continues to push the boundaries of the technology. A lightweight aluminium body structure with high torsional rigidity is the ideal platform for a sports car, and is fundamental to the way F-TYPE performs, handles and feels. A strong, stiff structure provides an inherently stable platform for precise, agile handling and allows the finely tuned suspension system to deliver connectivity and driver feedback. F-TYPE's body is the perfect complement to its high-performance engine range. Together they produce the exceptional power-to-weight and torque-to-weight ratios that deliver the real world measures of performance in a sports car.

All exterior panels are aluminium with the exception of the boot lid and tailgate, which are made from composite materials. These exterior panels are constructed from a new AC600 alloy that combines robustness and quality of finish with much greater formability for greater clarity and tightness of radii and feature lines. On Coupé models, the side pressing is one of the most technically advanced in the automotive industry and results in cleaner lines with an extraordinarily beautiful, uninterrupted sweep from the A pillar all the way to the trailing edge. Whichever F-TYPE you choose, the use of advanced materials and innovative techniques allowed Jaguar's engineers to reproduce F-TYPE's beautifully crisp, crafted lines exactly as the designers had intended, as well as delivering a vehicle with extraordinary structural integrity.





ON BALANCE



**OPTIMUM WEIGHT
DISTRIBUTION**

**LOW CENTRE
OF GRAVITY**

**PERFECT
PROPORTIONS**

It is essential in the design of a great sports car that weight is kept to a minimum, is evenly distributed front to rear and that the centre of gravity is kept as low as possible. This configuration in F-TYPE means that the car has natural balance and is the result of meticulous attention to detail during the design and construction of the body structure. An uncompromising focus on weight distribution achieves the optimum balance between front and rear wheels, with items such as the battery, electronic systems and even the washer bottle located at the rear of the car.

A shorter car is more agile; a wider car is more stable. The relationship between F-TYPE's length of 4,470mm and width of 1,923mm was precisely engineered to deliver inherent agility and means that the car has outstanding driving dynamics. Its low centre of gravity reduces body roll in corners, while short front and rear overhangs mean that the mass is concentrated within the wheelbase. These essential factors combine to ensure that F-TYPE is naturally agile.

MASS MOMENT OF INERTIA

The closer the weight is to the centre of the car, the easier it is to turn the car.

$$I = \sum_{i=1}^N m_i r_i^2$$

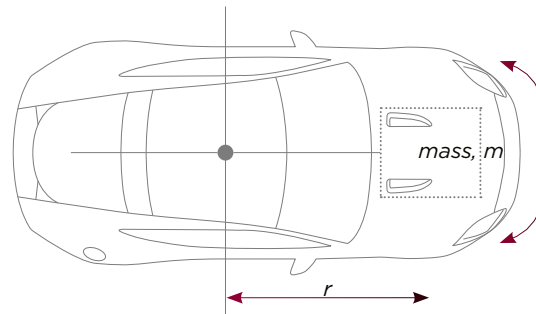

VEHICLE SHOWN: F-TYPE R IN POLARIS WHITE WITH JET AND RED DUOTONE PERFORMANCE SEATS AND OPTIONAL PANORAMIC ROOF



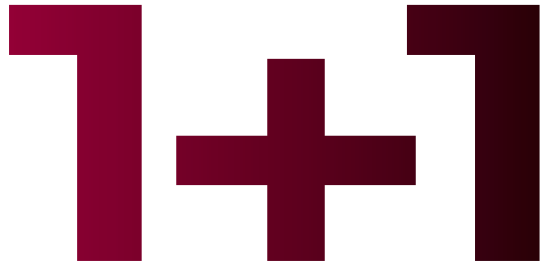

F-TYPE immediately connects with the driver, so that he or she becomes almost an extension of the car. Its 1+1 configuration is designed to wrap around the driver. The cockpit's design provides visibility, minimal distractions and close-to-the-centre-of-gravity seating with rigid seat frames and structure. The fascia has been intentionally kept as low as possible and free from clutter to increase the forward view. The **Intelligent Venting System**, part of the advanced climate control system, hides the twin central air vents which automatically deploy when required, rising from the dashboard and retracting after use. On F-TYPE Coupé models, an optional panoramic roof brings an atmosphere of increased light and airiness to the interior.

Two seat styles are available, the standard **Sports Seat**, and an optional **Performance Seat**, offering enhanced lateral support during rapid cornering and upholstered in Premium leather. For the ultimate in luxury, all models can also be specified with the optional **Premium leather interior**, which adds leather to the upper fascia, centre console and door casings. **Premium leather interior with twin needle stitching** and Performance Seats are standard on F-TYPE R.



JAGUAR
10:30 AM
14°C
18/08/2015 102635 km

Veloc Home menu		JAGUAR 10:30 AM	
Set-up	Audio/Video	CD 2	Groupie Armada
Cameras	Navigation	T+ 3:10	02:32
Dynamic-I	Phone	Valefajue	10:55 / 21km
Timed climate	Extra features	Destination entry	
		Christopher's phone	



AUTO A/C

P R N D S

DRIVER ORIENTATED CONTROLS

F-TYPE presents information to the driver only as necessary or when requested. Instruments are simple, clear and easy to read featuring two large analogue dials - essential in a sports car. The three spoke design of the steering wheel incorporates key functions, with gearshift paddles mounted behind the spokes for manual control without the need for the driver's hands to be taken from the wheel.

The **Jaguar SportShift Selector** is simple and intuitive to use, inviting greater driver involvement: it offers full Auto mode plus, in Sports mode, manual operation. This allows the driver to select gears sequentially by tipping the lever forward to shift down a ratio and shift up a gear by pulling the lever back.

Dual Mode Rotary Switches are used as part of the controls for the advanced climate control system. Right and left dials control cockpit temperature on the respective sides of the car when dual zone climate control is specified. When pressed, the dials change mode to control the optional seat heating functions, with the screen at the centre of the dial changing to display the corresponding use.

F-TYPE's **8 inch colour Touch-screen** provides simple control of a number of the car's features, including Navigation, Infotainment and, where specified, the Dynamic-i display system.

INTERIOR SHOWN: F-TYPE V8 S WITH PERFORMANCE SEATS IN CIRRUS PREMIUM LEATHER WITH JET UPPER FACIA AND STITCH



NARDO RING TEST TRACK

ITALY

700 hectares of land with a
6.2 km long handling circuit
and a 12.5 km long oval

**HIGH-SPEED
STABILITY TESTING**



NÜRBURGRING NORDSCHLEIFE

GERMANY

Asphalt and concrete mixed surface.
20.8 km long with 73 turns

**DIFFERENTIALS
TESTING**



PUT TO THE TEST

F-TYPE first took to the road in the virtual world of Jaguar's Computer Aided Engineering (CAE) systems ensuring that all components underwent extensive development and testing before being committed to the physical testing process. Engineers produced a series of virtual prototypes to realistically simulate the behaviour of complex mechanical systems allowing them to analyse multiple variations until the optimum design was achieved. For example, using a technique first used in the aerospace industry, aerodynamic testing took place in a virtual wind tunnel with Computational Fluid Dynamics running on high speed supercomputers. During its virtual life, F-TYPE completed half a million analyses, requiring 10 million computer processor hours and creating 300TB of data. The CAE development process was one of the key contributing factors in delivering F-TYPE's exhilarating performance and responsiveness.



**COMPUTER AIDED
ENGINEERING**

**COMPUTATIONAL
FLUID DYNAMICS**

**10 MILLION
PROCESSOR HOURS**

The real world testing to prove the car and fine tune the set-up took place in specialist facilities and the harshest environments across the globe in temperatures ranging from -40°C to +50°C, and at altitudes of up to 4,000m. High-speed stability tests, for example, were conducted at Nardo in southern Italy. The Nordschleife circuit at the Nürburgring in Germany was the perfect location to prove out handling, braking, cooling and durability. Known as the “Green Hell”, and featuring 20.8 kilometres of track with 73 turns, it is renowned as the most demanding circuit in the world and the ultimate test of both car and driver.





A CAR THAT FEELS ALIVE

The essential ingredients in place, F-TYPE is ready to take on the world's most thrilling roads. You'll discover an intuitive and instinctive driving experience like no other. An experience that surpasses high performance and pin sharp handling to deliver pure entertainment. The most awe-inspiring and exhilarating twists and turns on the road belong to F-TYPE.



ACTIVE AERODYNAMICS

Aerodynamic performance is the essence of F-TYPE's design and is seamlessly integrated into the body for low levels of lift and excellent stability at high speed. A front splitter beneath the grille and rear venturi manages airflow along the vehicle's underside with the sharply defined tail helping air to separate cleanly at lower speeds. A deployable rear spoiler rises at higher speeds to reduce lift by up to 120kg. Even the door handles retract when not required, with their flush design creating an uninterrupted airflow along the flanks.





THE FASTEST CONNECTION BETWEEN DRIVER AND ROAD

F-TYPE's quick, responsive steering is designed to provide the most direct connection between the driver's hands on the wheel and the contact point of the tyres on the road. The car's quick steering rack delivers a precise reaction to driver input. The feeling of connection is also maximised by the use of aluminium alloy for the front subframe. This not only helps to reduce weight, but, in conjunction with F-TYPE's forged alloy suspension, also creates an immensely strong structure for the ultimate in precise feedback and control.

VEHICLES SHOWN: F-TYPE V8 S IN SALSA RED





CHASSIS AND SUSPENSION

F-TYPE's aluminium body creates an immensely stable platform from which the all-round forged aluminium double wishbone suspension can control the car. With the damping set-up optimised for the best partnership between dynamics and refinement, it gives the perfect combination of control, agility and feedback.

On **F-TYPE S**, **F-TYPE V8 S** and **F-TYPE R** models, Adaptive Damping assesses body motion and pitch rates 100 times per second, and adjusts the settings for each damper accordingly. The system improves control, handling and agility as well as the ability to rapidly detect and react to critical driving conditions and driver demands. It achieves this with a series of sensors that are placed around the car to monitor the body's vertical movement, pitch and roll rates. The steering wheel position is measured 500 times a second enabling the system to predict the body's roll rate. The stiffness of each individual damper is then adjusted to help maintain body control, stability and agility.

MONITORS ROAD-INDUCED BODY
MOTION **100 TIMES** PER SECOND

MONITORS STEERING
WHEEL INPUT **500 TIMES**
PER SECOND

PREDICTS PITCH FROM
THROTTLE AND BRAKE INPUTS

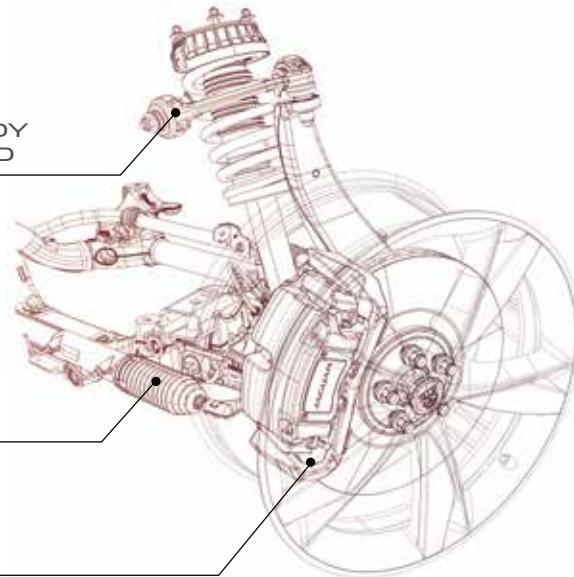

VEHICLES SHOWN: F-TYPE S IN RHODIUM SILVER



PERFORMANCE BRAKING SYSTEMS

A range of braking systems is available, each one engineered to deliver confident, progressive feel and sustained, consistent high performance. The front calipers make extensive use of aluminium to reduce the 'unsprung mass' of the car, benefiting both handling and ride refinement. Each system features large, ventilated brake discs - up to 380mm in diameter on the High Performance and Super Performance systems. This large 'swept area' improves braking force as well as providing greater capacity for the discs to absorb and dissipate the heat energy generated during braking.

Brake cooling is also enhanced with additional suspension scoops and ducts developed with the assistance of advanced Computational Fluid Dynamics systems. This channels cooling air directly to the brakes, reducing fade, and helping sustain their performance during extended periods of dynamic driving.

F-TYPE
JAGUAR
PERFORMANCE



CALIPERS: SILVER (STANDARD)
RED (OPTIONAL)

F-TYPE S
JAGUAR HIGH
PERFORMANCE



CALIPERS: BLACK (STANDARD)
RED (OPTIONAL)

F-TYPE V8 S AND F-TYPE R
JAGUAR SUPER
PERFORMANCE*

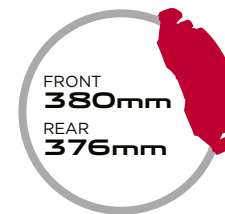

CALIPERS: BLACK (STANDARD ON V8 S)
RED (STANDARD ON R AND OPTIONAL ON V8 S)

*Jaguar Super Performance brakes available as an option on F-TYPE and F-TYPE S models

VEHICLE SHOWN: F-TYPE V8 S IN SALSA RED



671 TCC

F-TYPE

5



JAGUAR
CARBON CERAMIC

CARBON CERAMIC BRAKES



SUSTAINED
HIGH PERFORMANCE

WEIGHT SAVING OVER
CONVENTIONAL SYSTEMS

Derived from motorsport technology, the optional Carbon Ceramic Braking system is available on **F-TYPE S**, **F-TYPE V8 S** and **F-TYPE R**. It is the most powerfully performing braking system ever fitted to a Jaguar road car. Instantly recognisable with striking yellow calipers and offering up to a 21kg weight saving, it further reduces unsprung mass with corresponding benefits to both ride and handling. The system features monobloc calipers with 6 pistons at the front and 4 pistons at the rear.

Providing greater resistance to fade and wear, as well as delivering high levels of sustained performance in even the most demanding conditions, the Carbon Ceramic Braking system was track tested over hundreds of hours at long and short course race circuits across Europe. These included the Nürburgring, Rockingham in the UK and Fiorano in northern Italy, which are all recognised as taking an extraordinary toll on brake components: temperatures on the Carbon Ceramic discs reached between 600 and 900 degrees centigrade during fast lap driving.

JAGUAR
CARBON CERAMIC*

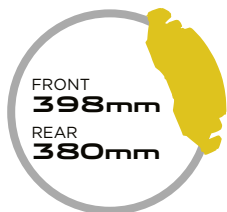

CALIPERS: YELLOW (STANDARD)

*Jaguar Carbon Ceramic brakes available as an option on F-TYPE S, F-TYPE V8 S and F-TYPE R models
Carbon Ceramic Braking system is available only with 20 inch Storm wheels

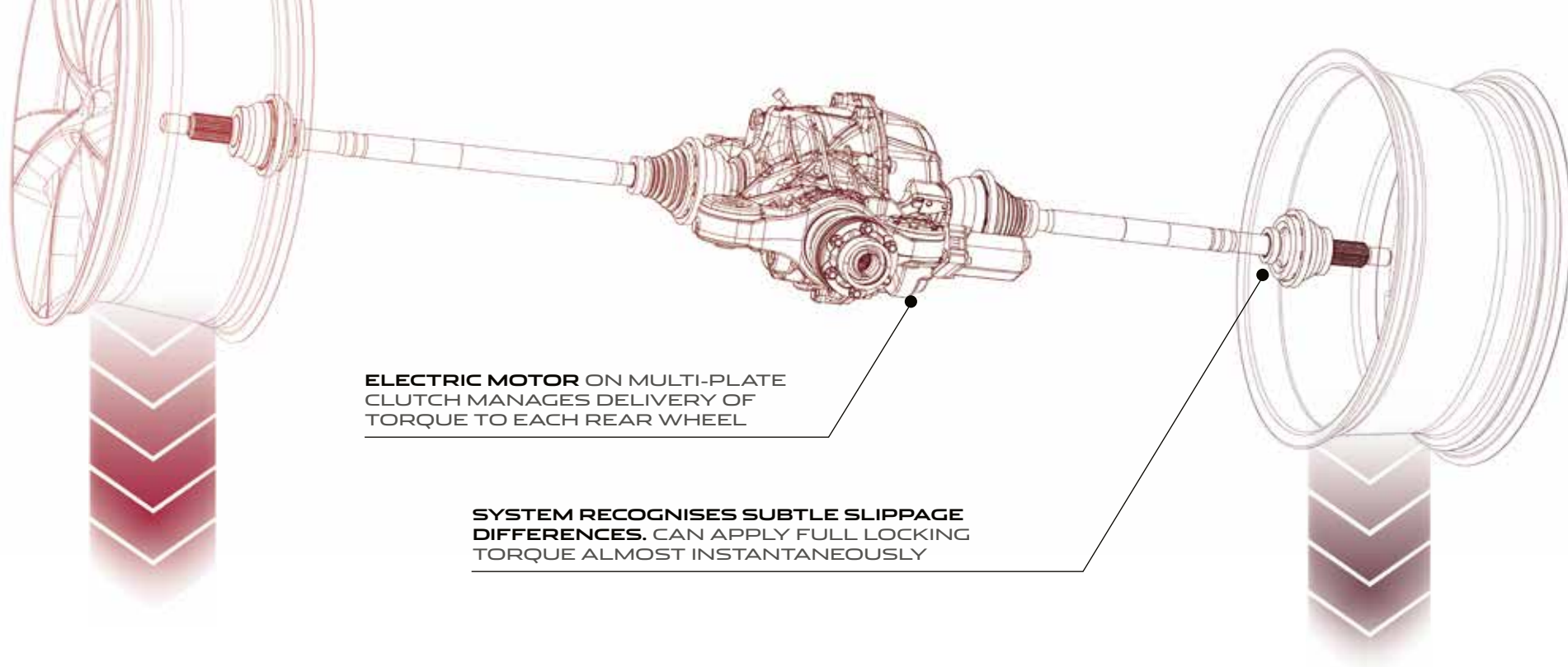

ELECTRIC MOTOR ON MULTI-PLATE CLUTCH MANAGES DELIVERY OF TORQUE TO EACH REAR WHEEL

SYSTEM RECOGNISES SUBTLE SLIPPAGE DIFFERENCES. CAN APPLY FULL LOCKING TORQUE ALMOST INSTANTANEOUSLY

DIFFERENTIALS

The mechanical **Limited Slip Differential** featured in **F-TYPE S** was chosen because of its innate suitability for the rear-wheel drive sports car experience. It offers the perfect opportunity to leverage the car's superb handling and the upper limits of its grip. The Limited Slip Differential improves traction and agility during acceleration out of corners and on slippery surfaces. The car can also make better use of the available traction before the DSC system needs to intervene and results in more refined stability control during dynamic driving.

An **Electronic Active Differential** on **F-TYPE V8 S** and **F-TYPE R** forms part of the Torque Vectoring technology which helps provide outstanding agility and control. Working in conjunction with the stability, traction and ABS systems, the Electronic Active Differential uses an electric motor acting on a multiplate clutch to manage the delivery of torque to each of the rear wheels. Full electronic control of the rear differential lock enables the system to apply full locking torque almost instantaneously. The Electronic Active Differential allows for very fine control of the power delivery to limit wheelspin, maximise traction and offer even greater levels of control.





ADAPTIVE DYNAMICS

Adaptive Dynamics instinctively modifies the car's response to road conditions and driver input, enhancing the driving experience. It analyses how the car is being driven by measuring acceleration and braking, cornering, as well as road load and kick down activation. It then uses sophisticated adaptive software to ensure that the most appropriate gear shift strategy is automatically selected. For even more responsive performance, the selection of Sport Mode alters the gear shift programme to deliver shorter shifts and hold ratios at higher revs for longer.

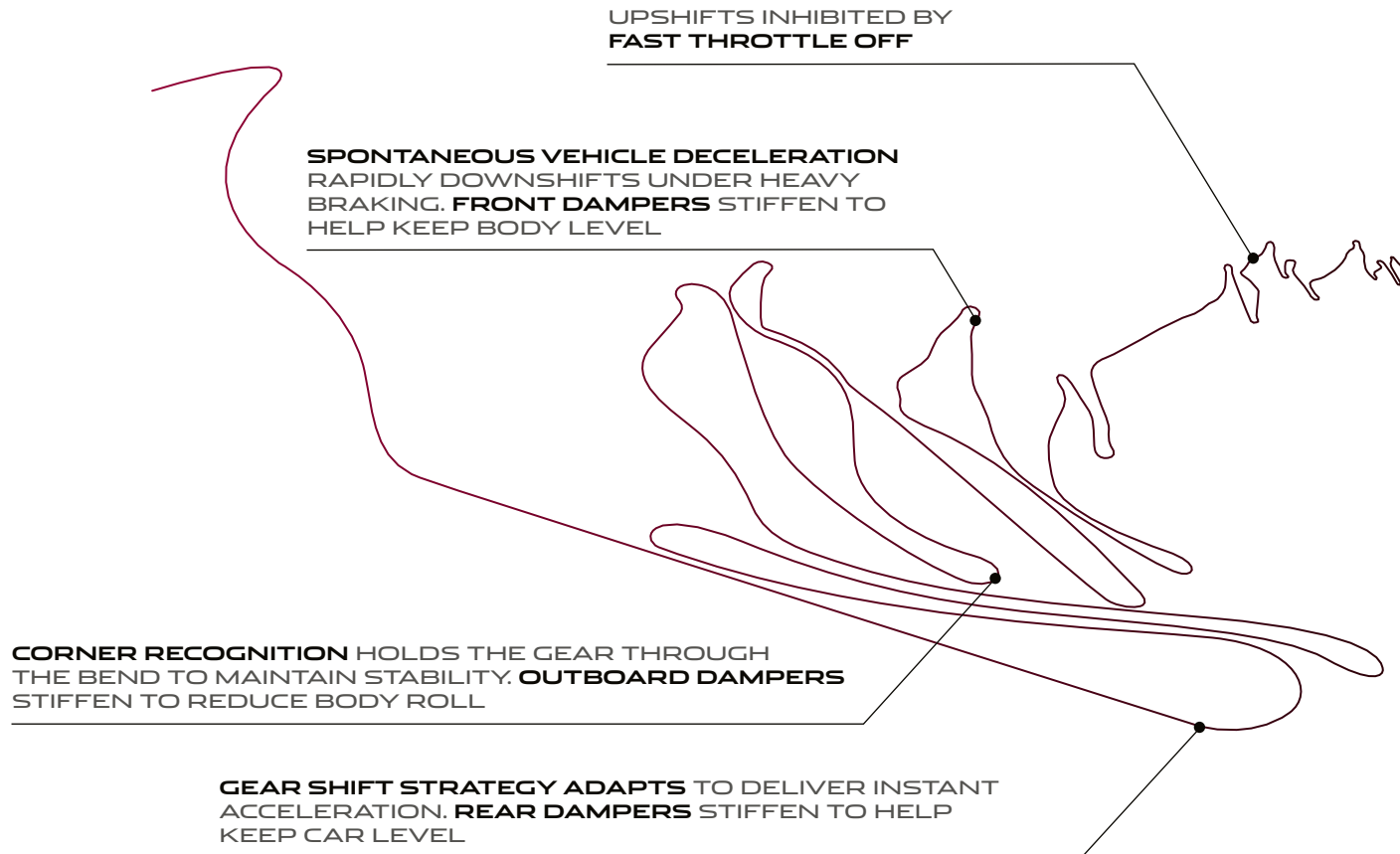



DYNAMIC MODE

➤ **SHARPENED** THROTTLE RESPONSE | **QUICKER** GEAR SHIFTS

Dynamic Mode remaps the car's software to further emphasise its sporting character. It sharpens the throttle response, increases steering weighting and performs gear shifts more quickly and at higher engine speeds. Selecting Dynamic Mode also prevents automatic upshifts when the gearbox is used in manual mode.

The **Configurable Dynamics** system, standard on **F-TYPE S**, **F-TYPE V8 S** and **F-TYPE R** allows the driver to define which characteristics are altered when Dynamic Mode is selected. This option also features the **Dynamic-i** display system, which can show performance indices such as G-Force meter and lap time, plus throttle, steering and brake inputs on the 8 inch Touch-screen.





R IS INTENSITY. IT PROVIDES MORE. AND DELIVERS THE ULTIMATE EXPRESSION
OF F-TYPE: THE MOST POWERFUL, THE MOST DYNAMICALLY CAPABLE,
THE MOST THRILLING. F-TYPE R IS THE SPORTS CAR AT ITS MOST HONED,
SENSUOUS AND EXCITING.









PERFORMANCE

> 5.0 V8 550PS | 680NM

F-TYPE R is the definitive sports car. Powered by Jaguar's incredible 5.0 V8 550PS supercharged engine with 680Nm of torque for sheer unadulterated performance that is 100 percent exploitable - 0-100 km/h in 4.2 seconds, best-in-class power output and power-to-weight. **F-TYPE R** takes full advantage of the extremely rigid bodyshell. Its stiffness provides the definitive platform for suspension enhancements that can apply available traction and fully harness the immense power on hand.

VEHICLE SHOWN RIGHT AND ON PREVIOUS PAGE: F-TYPE R IN POLARIS WHITE WITH OPTIONAL PANORAMIC ROOF, GYRODYNE DARK GREY AND DIAMOND TURNED ALLOY WHEELS AND BLACK PACK



545 VCC

F-TYPE

F-PACE



BRAKE PRESSURE IS APPLIED TO INSIDE REAR WHEEL

GREATER AMOUNT OF POWER IS DISTRIBUTED TO OUTER REAR WHEEL

ADDITIONAL ROTATIONAL FORCE APPLIED AROUND VEHICLE'S AXIS

TORQUE VECTORING



INCREASED STEERING PERFORMANCE

IMPROVED CORNERING CAPABILITY

F-TYPE R offers unparalleled levels of handling, grip and controllability. It has all the inherent duality of everyday usability with the character of an out-and-out sports car, putting the emphasis on greater agility and excitement and a crisper, edgier temperament.

F-TYPE R invites enthusiastic driving. Its supplemental Torque Vectoring technology provides controlled braking on the inside rear wheel, at the same time as feeding more power to the outside rear wheel, to help increase steering performance and inspire even greater driver confidence. The system works in conjunction with the **F-TYPE R**'s Electronic Active Differential to improve the cornering capabilities and driver control.



R INSIDE

> SPORTS
STEERING WHEEL

| 'R' EMBOSSED
HEADRESTS

F-TYPE R's interior dials up the intensity of the 1+1 experience to represent the pinnacle of Jaguar craftsmanship and dynamics. The R theme gives the car a unique personality and includes Dark Technical Weave Aluminium on the centre console finishers. There is premium leather with twin needle stitching and, for more lateral support during more enthusiastic driving, body-hugging performance seats with R embossed on the headrest. The car also features an R flat-bottomed sports steering wheel with Ignis paddles.*



INTERIOR SHOWN: F-TYPE R WITH PERFORMANCE SEATS IN JET AND IVORY DUOTONE
*3-SPOKE ROUND LEATHER STEERING WHEEL IS A NO-COST OPTION



ASSISTANCE AND REASSURANCE



BLIND SPOT MONITOR

REVERSE TRAFFIC DETECTION

INTELLIGENT HIGH BEAM

Sophisticated driver assistance systems are available to provide reassurance, information and control, and allow the driver to focus on the pleasure of the drive. These include **Cruise Control with Automatic Speed Limiter** and **Blind Spot Monitoring**, which is designed to help alert the driver to the presence of a vehicle in an adjacent lane. **Reverse Traffic Detection** can provide warnings of other vehicles in the reversing path of F-TYPE, for example when in a car park. **Front and Rear Parking aids** and a **Reverse Park Camera** also provide valuable assistance during parking manoeuvres.

Bi-Function HID Xenon headlamps provide an intense white light for both main and dipped beam in a single unit. The optional **Adaptive Front Lighting** system measures the speed of the car and angle of the steering wheel, swivelling the lamps by up to 14 degrees out, and up to 7 degrees in, for improved visibility during cornering. The optional **Intelligent High Beam** system automatically switches between low and high beam when necessary, using a sensor mounted at the front of the rear view mirror. The rear lamps feature LED technology with light guides that not only create a distinctive design, but also have the ability to illuminate to full brightness more quickly than conventional bulbs, potentially giving a following driver more time to react.

Every F-TYPE also features a complement of advanced active and passive safety systems, including **Emergency Brake Assist (EBA)**, **Electronic Brake-Force Distribution (EBD)**, driver and passenger front airbags, seat mounted airbags, seat belt pre-tensioners and an industry-leading **Pedestrian Contact Sensing System™**.

VEHICLE SHOWN: F-TYPE S IN LUNAR GREY





YOUR F-TYPE



**EXTERIOR
COLOURS**

**ALLOY
WHEELS**

**ROOF
OPTIONS**

**AUDIO
SYSTEMS**

**INTERIOR
TRIM**

**OPTION PACKS
AND ACCESSORIES**

It becomes your F-TYPE. The choices you make create the car you'll love. Select the body and roof colours that suit you and choose the perfect wheels to complement them. You can make your F-TYPE unique by tailoring your personal interior styling, specifying your ideal seats and choosing the textures and colour combinations, as well as taking your pick from the range of three superb audio systems including two from British audio experts Meridian. With Jaguar's exceptional collection of style-packs, accessories and options your F-TYPE becomes truly bespoke – your ideal sports car – your perfect F-TYPE.



MODELS

STANDARD FEATURES

Quickshift 8-speed automatic transmission with SportShift selector and steering wheel mounted one touch paddles

- Dynamic mode
- Dynamic Stability Control (DSC) with Trac DSC mode
- Intelligent Stop/Start system
- Electric Parking Brake (EPB) – drive-away release
- Deployable rear spoiler
- Bi-function HID Xenon headlamps with washers and LED signature lights
- LED tail lamps
- Jaguar Smart Key System™ with Keyless start
- Instrument cluster – twin dials with 5 inch colour TFT display
- 8 inch colour Touch-screen display
- Navigation system
- Jaguar 180W Sound System with single slot CD/DVD
- USB, Auxiliary socket and iPod connectivity
- Pedestrian Contact Sensing System™



F-TYPE CONVERTIBLE

ENGINE 3.0 Litre V6 340 Supercharged
ACCELERATION 0-100 km/h 5.3 seconds
(0-60 mph 5.1 seconds)
TOP SPEED 260 km/h (161 mph)
EMISSIONS CO₂ 209 g/km

Jaguar Performance Braking System with Silver calipers
Sports suspension
Sports Exhaust with centre mounted twin exhaust pipes
18 inch Vela alloy wheels
Electronically operated convertible roof
Sports seats with leather and Suedecloth facings
3-spoke leather steering wheel with Black gear shift paddles
Light Hex Aluminium console finisher



F-TYPE COUPÉ

ENGINE 3.0 Litre V6 340 Supercharged
ACCELERATION 0-100 km/h 5.3 seconds
(0-60 mph 5.1 seconds)
TOP SPEED 260 km/h (161 mph)
EMISSIONS CO₂ 205 g/km

Jaguar Performance Braking System with Silver calipers
Sports suspension
Sports Exhaust with centre mounted twin exhaust pipes
18 inch Vela alloy wheels
Sports seats with leather and Suedecloth facings
3-spoke leather steering wheel with Black gear shift paddles
Light Hex Aluminium console finisher



F-TYPE S CONVERTIBLE

ENGINE 3.0 Litre V6 380 Supercharged
ACCELERATION 0-100 km/h 4.9 seconds
(0-60 mph 4.8 seconds)
TOP SPEED 275 km/h (171 mph)
EMISSIONS CO₂ 213 g/km

Jaguar High Performance Braking System with Black calipers
Sports suspension with Adaptive Dynamics
Active Sports Exhaust with centre mounted twin exhaust pipes
19 inch Propeller Silver alloy wheels
Electronically operated convertible roof
Configurable Dynamics System
Limited Slip Differential
Sports seats with leather and Suedecloth facings
3-spoke leather steering wheel with Ignis gear shift paddles
Dark Hex Aluminium console finisher with 'S' graphic
Configurable Ambient Interior Lighting with selectable palette



F-TYPE S COUPÉ

ENGINE 3.0 Litre V6 380 Supercharged
ACCELERATION 0-100 km/h 4.9 seconds
(0-60 mph 4.8 seconds)
TOP SPEED 275 km/h (171 mph)
EMISSIONS CO₂ 213 g/km

Jaguar High Performance Braking System with Black calipers
Sports suspension with Adaptive Dynamics
Active Sports Exhaust with centre mounted twin exhaust pipes
19 inch Propeller Silver alloy wheels
Configurable Dynamics System
Limited Slip Differential
Sports seats with leather and Suedecloth facings
3-spoke leather steering wheel with Ignis gear shift paddles
Dark Hex Aluminium console finisher with 'S' graphic
Configurable Ambient Interior Lighting with selectable palette



F-TYPE V8 S CONVERTIBLE

ENGINE 5.0 Litre V8 495 Supercharged
ACCELERATION 0-100 km/h 4.3 seconds
(0-60 mph 4.2 seconds)
TOP SPEED 300 km/h (186 mph)
EMISSIONS CO₂ 259 g/km

Jaguar Super Performance Braking System with Black calipers
Sports suspension with Adaptive Dynamics
Switchable Active Sports Exhaust with quad exhaust pipes
20 inch Turbine Silver alloy wheels
Electronically operated convertible roof
Configurable Dynamics System
Electronic Active Differential
Sports seats with leather facings
3-spoke leather steering wheel with Ignis gear shift paddles
Dark Hex Aluminium console finisher with 'S' graphic
Configurable Ambient Interior Lighting with selectable palette



F-TYPE R COUPÉ

ENGINE 5.0 Litre V8 550 Supercharged
ACCELERATION 0-100 km/h 4.2 seconds
(0-60 mph 4.0 seconds)
TOP SPEED 300 km/h (186 mph)
EMISSIONS CO₂ 259 g/km

Jaguar Super Performance Braking System with Red calipers
Sports suspension with Adaptive Dynamics
Switchable Active Sports Exhaust with quad exhaust pipes
20 inch Gyrodyne Silver alloy wheels
Configurable Dynamics System
Electronic Active Differential with Torque Vectoring by braking
Performance seats with leather facings and 'R' embossing
3-spoke leather flat-bottomed steering wheel with Ignis gear shift paddles
Dark Technical Weave Aluminium console finisher with 'R' graphic
Configurable Ambient Interior Lighting with selectable palette

> EXPRESS YOURSELF IN COLOUR

STANDARD



Ebony



Salsa Red



Polaris White

PREMIUM



Dark Sapphire+



Ultimate Black+



Stratus Grey+

RACE INSPIRED

SPECIAL



Italian Racing Red*



Firesand*



Black Amethyst*



British Racing Green*



Lunar Grey*



Rhodium Silver*

*Metallic paint *Xirallic paint

Black Pack, Design Pack and Design Pack with Black Pack available as an option in Ultimate Black, Polaris White, Italian Racing Red, Rhodium Silver, Firesand and Salsa Red. Also available in other colours as a Dealer Fit Accessory, please contact your local Jaguar dealer for details.

ALLOY WHEELS

Complete your F-TYPE's stunning appearance with the perfect wheels. Your choice of size, alloy or lightweight forged alloy, spoke patterns and finish - Silver, Gloss Black, Black and Diamond Turned or Carbon Fibre.

> 18" ALLOY WHEEL



18" VELA
SILVER
Standard on F-TYPE

> 19" ALLOY WHEELS



19" PROPELLER
SILVER
Standard on F-TYPE S
Option on F-TYPE



19" CENTRIFUGE
SILVER
Option on F-TYPE
and F-TYPE S



19" CENTRIFUGE
GLOSS BLACK
Option on F-TYPE
and F-TYPE S



19" ORBIT
SILVER
Option on F-TYPE
and F-TYPE S



19" ORBIT
BLACK AND DIAMOND TURNED
Option on F-TYPE
and F-TYPE S

 Configure your vehicle at [JAGUAR.COM](https://www.jaguar.com)



20" ALLOY WHEELS



20" TURBINE
SILVER
Standard on F-TYPE V8 S
Option on F-TYPE,
F-TYPE S and F-TYPE R



20" CYCLONE
SILVER
Option on all F-TYPE models



20" CYCLONE
GLOSS BLACK
Option on all F-TYPE models



20" TORNADO
SILVER
Option on all F-TYPE models



20" TORNADO
GLOSS BLACK
Option on all F-TYPE models



20" BLADE
FORGED ALLOY TECHNICAL
GREY/CARBON FIBRE
Option on all F-TYPE models



20" ROTOR
FORGED ALLOY
Option on all F-TYPE models



20" GYRODYNE
SILVER
Standard on F-TYPE R



20" GYRODYNE
DARK GREY AND
DIAMOND TURNED
Option on F-TYPE R



20" STORM
SATIN ANTHRACITE GREY
Option on F-TYPE S,
F-TYPE V8 S
and F-TYPE R*



20" STORM FORGED ALLOY
BLACK AND DIAMOND TURNED
Option on F-TYPE S,
F-TYPE V8 S
and F-TYPE R*

*Only available when Carbon Ceramic Brakes are specified

EVEN THE ROOF IS FAST

F-TYPE's fabric roof offers both light weight and refinement with the outer canopy acoustically enhanced with composite fabric and a flush fitting heated rear window glass. The roof can be raised or lowered in just **12 seconds** and operated fully automatically at speeds of **up to 50 km/h**. Its neat, compact stowage keeps the rear of the car low and sleek and avoids the need for a tonneau cover - another weight saving. An optional removable wind deflector can also be fitted between the roll over protection bars.



VEHICLES SHOWN: F-TYPE V8 S IN SALSA RED WITH GLOSS BLACK SIDE POWER VENT ACCESSORY





 CONVERTIBLE ROOFS

Jet

Grey

Red

Beige





THE LUXURY OF SPACE



407 LITRES

OPTIONAL POWERED TAILGATE

F-TYPE Coupé models offer the useability and practicality of a single rear loadspace area. With a capacity of up to 407 litres, it is large enough to accommodate a full set of luggage. For ease of access and added convenience, the tailgate can be opened or closed at the touch of a button with the optional powered function.



PANORAMIC GLASS ROOF

Introducing even more natural light and airiness to the interior, a full width panoramic roof is optional on F-TYPE Coupé models. For increased seclusion, should it be required, this option features an interior blind that can be closed manually.



VEHICLE SHOWN: F-TYPE R IN POLARIS WHITE WITH OPTIONAL PANORAMIC ROOF AND BLACK PACK

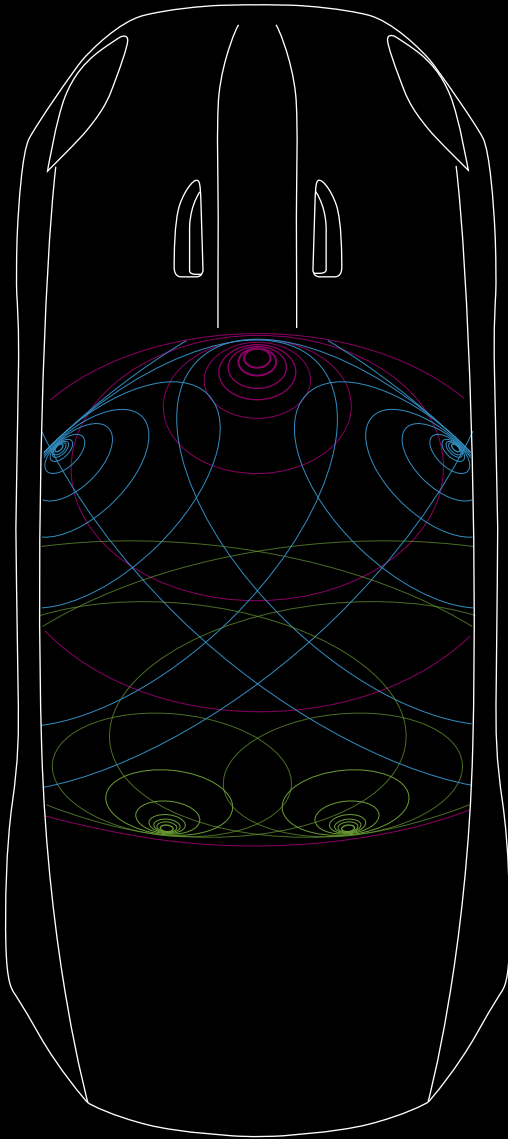

PEAK PERFORMANCE

 **JAGUAR**
SOUND SYSTEM

MERIDIAN SOUND AND
SURROUND SOUND SYSTEMS

Three superb audio systems bring the cockpit to life with incredible, rich sound. The superb **Jaguar Sound System** brings depth and power to in-car entertainment with 6 speakers, **180W** and 8 channels. The system features Dynamic Volume Control which compensates for changes in sound levels within the car to ensure that audio quality is always consistent.

Two higher specification systems were designed in conjunction with British audio experts Meridian specifically for F-TYPE. They feature advanced technology, such as Digital Signal Processing (DSP) technology, to optimise every element of the system and use Meridian Cabin Correction's advanced algorithm to tailor the music experience to the precise acoustics of the vehicle's interior. The **Meridian Sound System** offers superb audio reproduction through 10 speakers - including 2 sub woofers, **380W** and 12 channels.

The ultimate **Meridian Surround Sound System** features 12 speakers and **770W**. This advanced system uses Meridian Trifield technology to deliver an authentic and consistent music experience within the cabin.



-  Holographic Centre Image
-  Door Waves: Tweeter, Midrange and Bass
-  Surround Sound Waves

Diagram representative of Meridian 770W Surround Sound System.



MERIDIAN



180 WATTS

6 SPEAKERS

8 AMPLIFIER CHANNELS

JAGUAR 180W

180W, 6 Speakers, 8 channel amplifier, Audyssey MultEQ Audio Equalisation, Dynamic volume control



380 WATTS

10 SPEAKERS

12 AMPLIFIER CHANNELS

MERIDIAN 380W

380W, 10 Speakers, 12 channel class D DSP amplifier, Audyssey MultEQ Audio Equalisation, Dynamic volume control



770 WATTS

12 SPEAKERS

16 AMPLIFIER CHANNELS

MERIDIAN SURROUND 770W

770W, 12 Speakers, 16 channel class D DSP amplifier, Audyssey MultEQ Audio Equalisation, Dynamic volume control, 7.1 Surround Sound, Meridian Trifield technology

THE FEELING INSIDE





F-TYPE's interior conveys a combination of functional ergonomics with sporting style through its meticulously considered cockpit architecture, its simple controls and its clear instrumentation. It is designed to put the driver first and to be an opportunity for individual expression. Everything offers a rewarding, highly tactile experience with extensive ranges of fine leathers, colours and materials making it more personal. Push the Start button and the car comes alive with a cascade of light from the switchgear. **Configurable Lighting**, standard on **F-TYPE S**, **F-TYPE V8 S** and **F-TYPE R**, adds even greater personalisation with choices of Phosphor Blue, Pale Blue, White, Coral or Red to suit the driver's mood. Activate Dynamic Mode and the lighting switches to Red on the door grab handles, centre console and instrument cluster.

SEATS

Two seat styles are available, both offering superb comfort and support. On **F-TYPE** and **F-TYPE S** the **Sports Seat** with leather and Suedecloth facings is standard. **F-TYPE V8 S** models gain the added luxury of full leather facings. All models can be specified with the optional **Performance Seat** with Premium leather which offers enhanced lateral support during rapid cornering. **F-TYPE R** features the **Performance Seat** as standard with the R badge embossed on the headrest. Both the Sports and Performance seats feature 4 way electric and 2 way manual adjustment, or 14 way electric adjustment and memory function as an option. They can also be specified with a heated function. For the finishing touch, it is also possible to choose between Jet, Red or Camel seatbelts.

Now you're ready to choose just the right interior colour combination from Jaguar's exclusive collection.



SPORTS SEAT



PERFORMANCE SEAT



R PERFORMANCE SEAT

 **SEAT TRIM****Jet leather**

(Also available in Suedecloth,
and Premium leather)

Mineral leather

(Also available in Suedecloth,
and Premium leather)

Cirrus leather

(Also available in Suedecloth,
and Premium leather)

**Red
Premium leather****Brogue
Premium leather****Camel
Premium leather****Ivory
Premium leather**

> INTERIOR COLOUR COMBINATIONS

SPORTS SEATS WITH LEATHER AND SUEDECLOTH FACINGS

STANDARD ON F-TYPE AND F-TYPE S MODELS



SEAT WITH STITCH

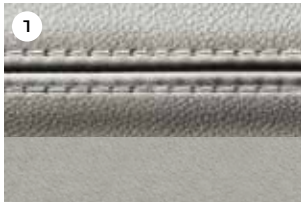

Cirrus with Cirrus

UPPER FACIA WITH STITCH



Jet with Jet

CONSOLE FINISHER



Light Hex

HEADLINING

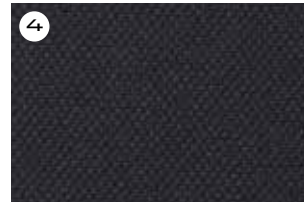

Jet

CARPETS

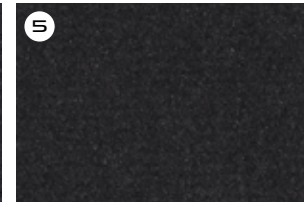

Jet

F-TYPE with Cirrus leather and Suedecloth Sports seats with Jet upper fascia and stitch, Jet Morzine headlining with Light Hex Aluminium console finisher and Jet carpets.

1. Seat with stitch - colour applies to seats, door trim inserts and grab handle.

2. Upper fascia with stitch - colour applies to dashboard, centre console armrest and upper door trims.

SEAT WITH STITCH



Jet with Jet

UPPER FACIA WITH STITCH



Jet with Jet

CONSOLE FINISHER

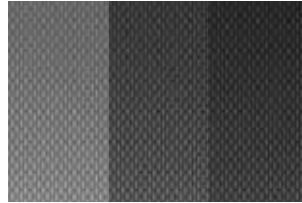

Light, Dark or Black Hex¹

HEADLINING



Jet or Stone

CARPETS

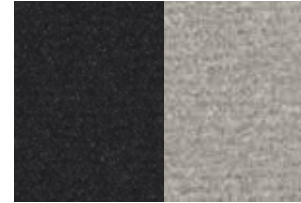

Jet or Cirrus

SEATBELTS



Jet or Red

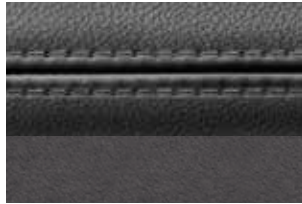

Mineral with Mineral

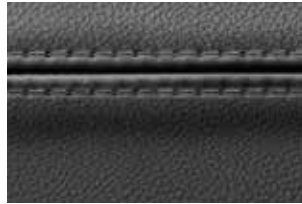

Mineral with Mineral

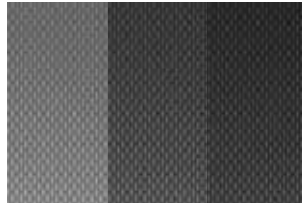

Light, Dark or Black Hex¹



Jet or Stone

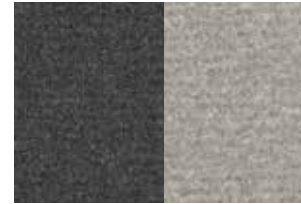

Mineral or Cirrus



Jet

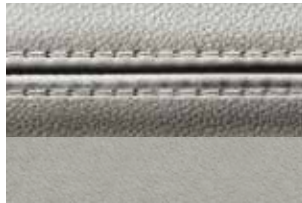

Cirrus with Cirrus



Jet with Jet

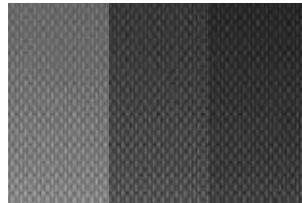

Light, Dark or Black Hex¹



Jet or Stone

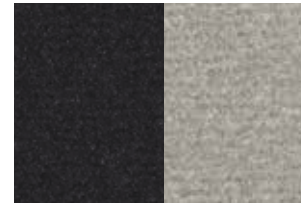

Jet or Cirrus



Jet

¹Black Hex Aluminium console finisher only available with Interior Black Pack

SPORTS SEATS WITH LEATHER FACINGS

STANDARD ON F-TYPE V8 S, OPTIONAL ON F-TYPE AND F-TYPE S MODELS



SEAT WITH STITCH



Mineral with Mineral

UPPER FACIA WITH STITCH



Mineral with Mineral

CONSOLE FINISHER

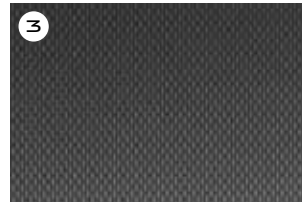

Dark Hex

HEADLINING

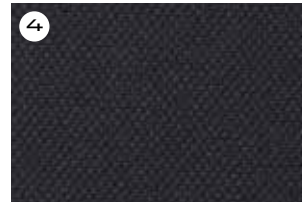

Jet

CARPETS

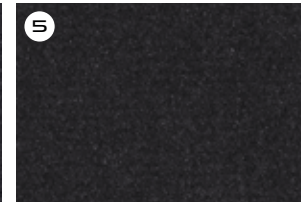

Jet

F-TYPE S with Mineral leather Sports seats with Mineral upper facia and stitch, Jet Morzine headlining with Dark Hex Aluminium console finisher and Jet carpets.

1. Seat with stitch - colour applies to seats, door trim inserts and grab handle.

2. Upper facia with stitch - colour applies to dashboard, centre console armrest and upper door trims.

SEAT WITH STITCH



Jet with Jet

UPPER FACIA WITH STITCH



Jet with Jet

CONSOLE FINISHER

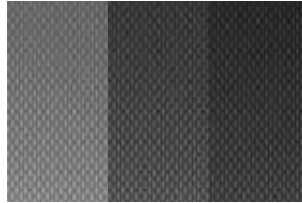

Light, Dark or Black Hex¹

HEADLINING



Jet or Stone

CARPETS

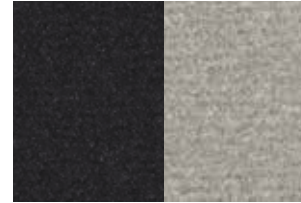

Jet or Cirrus

SEATBELTS



Jet or Red

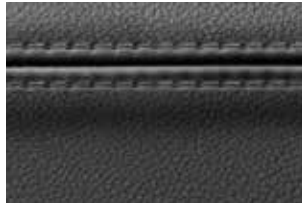

Mineral with Mineral



Mineral with Mineral

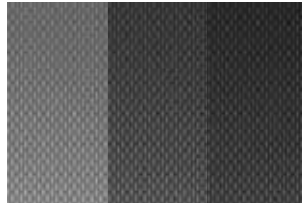

Light, Dark or Black Hex¹



Jet or Stone

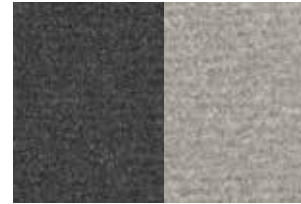

Mineral or Cirrus



Jet



Cirrus with Cirrus



Jet with Jet



Light, Dark or Black Hex¹



Jet or Stone

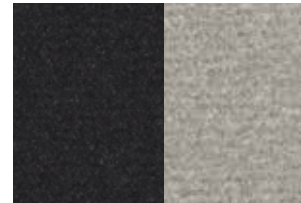

Jet or Cirrus



Jet

¹Black Hex Aluminium console finisher only available with Interior Black Pack

SPORTS SEATS IN LEATHER AND PREMIUM LEATHER INTERIOR

OPTIONAL ON F-TYPE, F-TYPE S AND F-TYPE V8 S MODELS



SEAT WITH STITCH



Jet with Jet

UPPER FACIA WITH STITCH



Jet with Jet

CONSOLE FINISHER

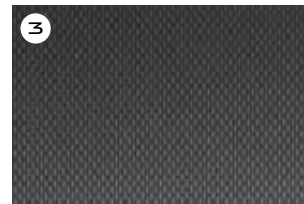

Dark Hex

HEADLINING

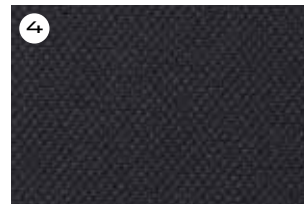

Jet

CARPETS

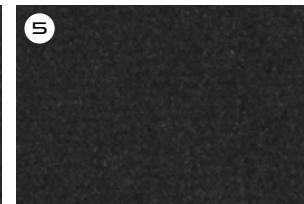

Jet

F-TYPE S with Jet leather Sports seats with Jet Premium leather upper fascia and stitch, Jet Morzine headlining with Dark Hex Aluminium console finisher and Jet carpets.

1. Seat with stitch - colour applies to seats, door trim inserts and grab handle.

2. Upper fascia with stitch - colour applies to dashboard, centre console armrest and upper door trims.

SEAT WITH STITCH



Jet with Jet

UPPER FACIA WITH STITCH

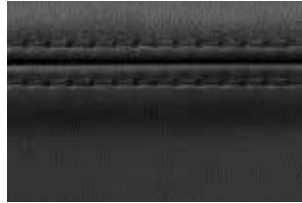

Jet with Jet

CONSOLE FINISHER

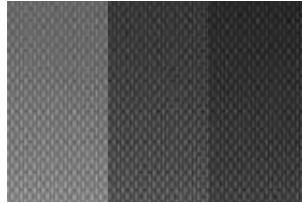

Light, Dark or Black Hex¹

HEADLINING*



Jet, Stone or Red[†]

CARPETS

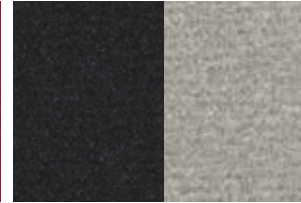

Jet or Cirrus

SEATBELTS



Jet or Red



Mineral with Mineral



Mineral with Mineral

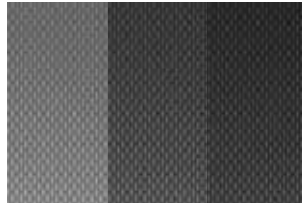

Light, Dark or Black Hex¹

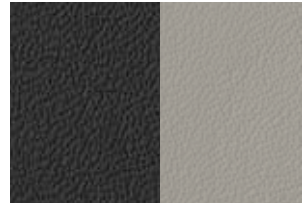

Jet or Stone

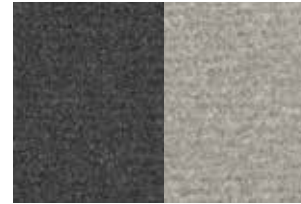

Mineral or Cirrus



Jet

¹Black Hex Aluminium console finisher only available with Interior Black Pack

*Jet Morzine standard, Stone Morzine and Jet Suedecloth optional. Leather swatches shown, also available as an option when Extended Leather Pack is selected

[†]Red headlining available on Convertible only

PERFORMANCE SEATS IN PREMIUM LEATHER

OPTIONAL ON F-TYPE, F-TYPE S AND F-TYPE V8 S MODELS



SEAT WITH STITCH



Cirrus with Cirrus

UPPER FACIA WITH STITCH



Jet with Jet

CONSOLE FINISHER

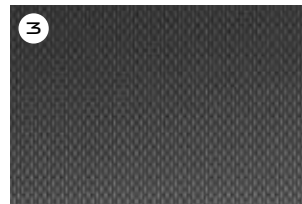

Dark Hex

HEADLINING

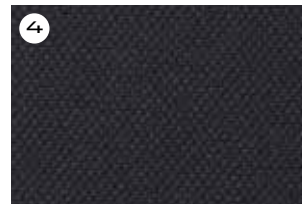

Jet

CARPETS

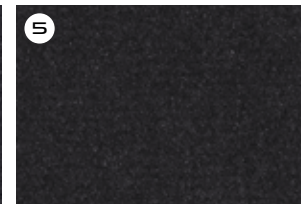

Jet

F-TYPE V8 S with Cirrus Premium leather Performance seats with Jet upper facia and stitch, Jet Morzine headlining with Dark Hex Aluminium console finisher and Jet carpets.

1. Seat with stitch - colour applies to seats, door trim inserts and grab handle.

2. Upper facia with stitch - colour applies to dashboard, centre console armrest and upper door trims.

SEAT WITH STITCH

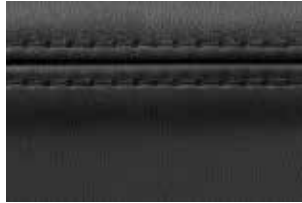

Jet with Jet

UPPER FACIA WITH STITCH

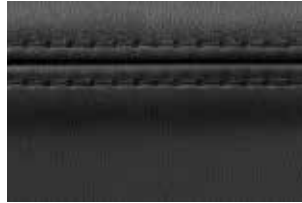

Jet with Jet

CONSOLE FINISHER

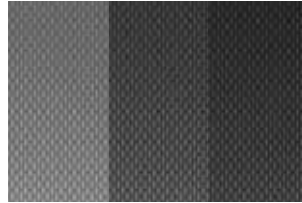

Light, Dark or Black Hex¹

HEADLINING



Jet or Stone

CARPETS

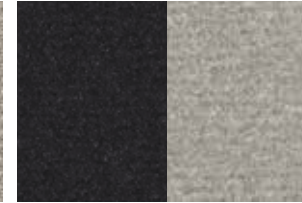

Jet or Cirrus

SEATBELTS



Jet or Red



Mineral with Mineral



Mineral with Mineral

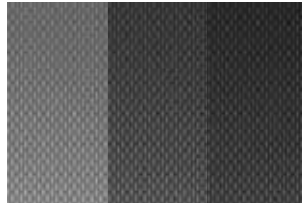

Light, Dark or Black Hex¹



Jet or Stone

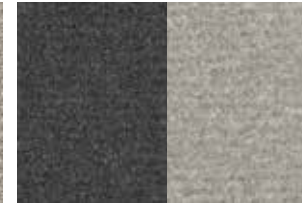

Mineral or Cirrus



Jet



Cirrus with Cirrus

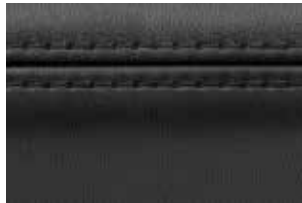

Jet with Jet



Light, Dark or Black Hex¹



Jet or Stone

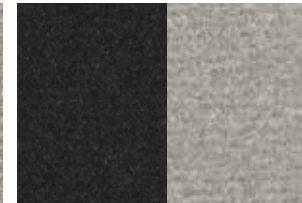

Jet or Cirrus



Jet

¹Black Hex Aluminium console finisher only available with Interior Black Pack

PERFORMANCE SEATS IN PREMIUM LEATHER AND PREMIUM LEATHER INTERIOR
OPTIONAL ON F-TYPE, F-TYPE S AND F-TYPE V8 S MODELS



SEAT WITH STITCH



Red with Jet

UPPER FACIA WITH STITCH



Jet with Jet

CONSOLE FINISHER

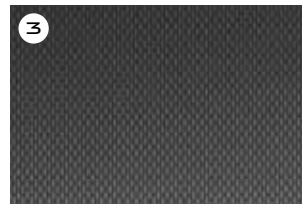

Dark Hex

HEADLINING



Jet

CARPETS

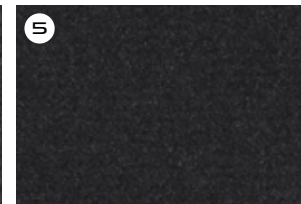

Jet

F-TYPE V8 S with Red Premium leather Performance seats with Premium leather interior, Jet leather headlining with Dark Hex Aluminium console finisher and Jet carpets.

1. Seat with stitch - colour applies to seats, door trim inserts and grab handle.
2. Upper fascia with stitch - colour applies to dashboard, centre console armrest and upper door trims.

SEAT WITH STITCH

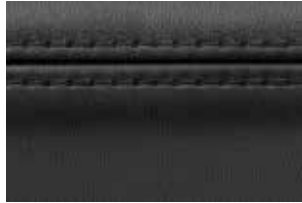

Jet with Jet

UPPER FACIA WITH STITCH

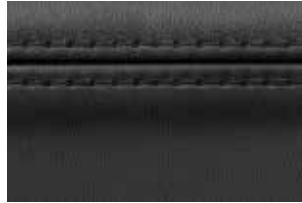

Jet with Jet

CONSOLE FINISHER

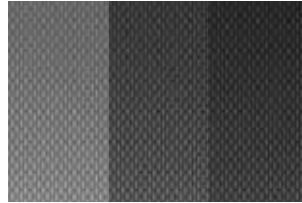

Light, Dark or Black Hex¹

HEADLINING*



Jet, Stone or Red[†]

CARPETS

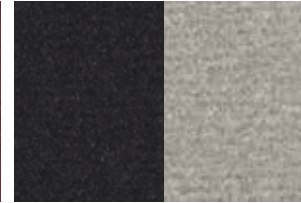

Jet or Cirrus

SEATBELTS



Jet or Red



Mineral with Mineral



Mineral with Mineral



Light, Dark or Black Hex¹

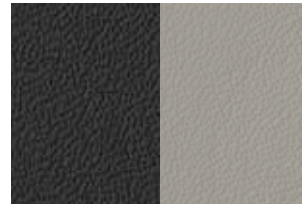

Jet or Stone



Mineral or Cirrus



Jet



Jet with Red



Jet with Jet



Light, Dark or Black Hex¹



Jet, Stone or Red[†]

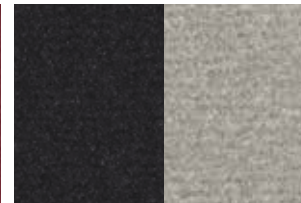

Jet or Cirrus



Jet or Red

¹Black Hex Aluminium console finisher only available with Interior Black Pack

*Jet Morzine standard, Stone Morzine and Jet Suedecloth optional. Leather swatches shown, also available as an option when Extended Leather Pack is selected

[†]Red headlining available on Convertible only

SEAT WITH STITCH



Jet with Camel

UPPER FACIA WITH STITCH

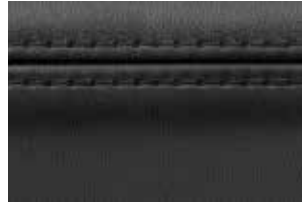

Jet with Jet

CONSOLE FINISHER

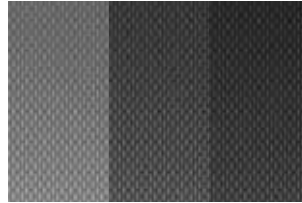

Light, Dark or Black Hex¹

HEADLINING*

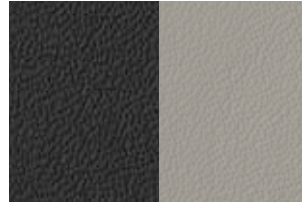

Jet or Stone

CARPETS



Jet, Cirrus or Camel

SEATBELTS



Jet or Camel



Jet with Firesand

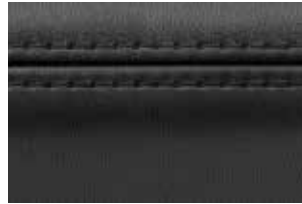

Jet with Jet

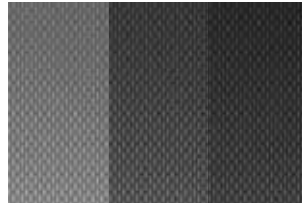

Light, Dark or Black Hex¹

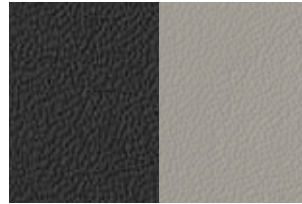

Jet or Stone

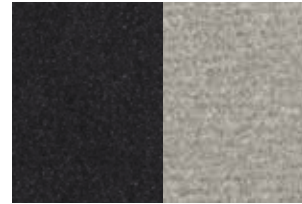

Jet or Cirrus



Jet



Mineral with Cirrus



Mineral with Mineral

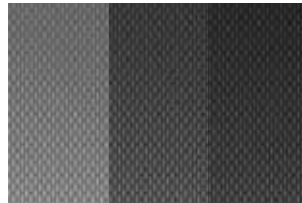

Light, Dark or Black Hex¹

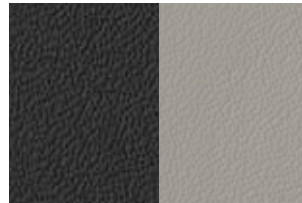

Jet or Stone



Mineral or Cirrus



Jet

¹Black Hex Aluminium console finisher only available with Interior Black Pack

*Jet Morzine standard, Stone Morzine and Jet Suede cloth optional. Leather swatches shown, also available as an option when Extended Leather Pack is selected

SEAT WITH STITCH



Cirrus with Mineral

UPPER FACIA WITH STITCH

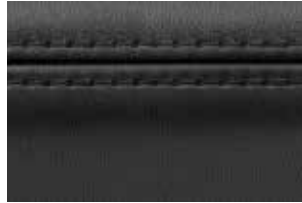

Jet with Jet

CONSOLE FINISHER

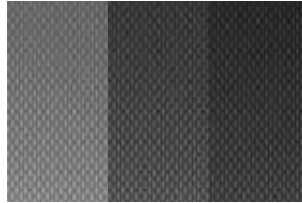

Light, Dark or Black Hex¹

HEADLINING*

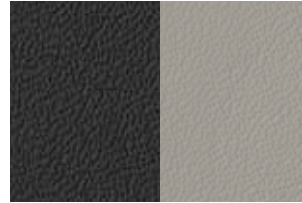

Jet or Stone

CARPETS

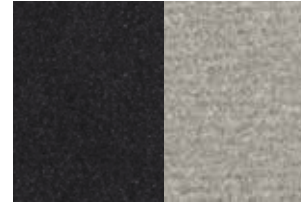

Jet or Cirrus

SEATBELTS



Jet



Cirrus with Mineral



Mineral with Mineral

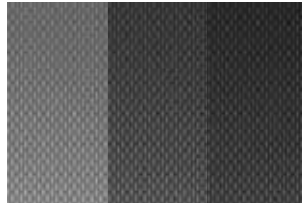

Light, Dark or Black Hex¹

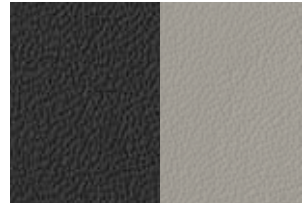

Jet or Stone

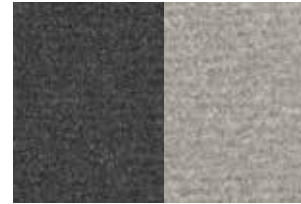

Mineral or Cirrus



Jet



Brogue with Ivory

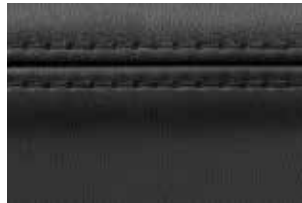

Jet with Jet



Light, Dark or Black Hex¹

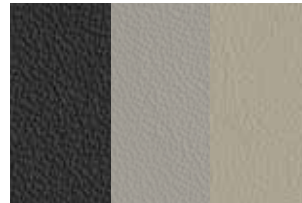

Jet, Stone or Ivory

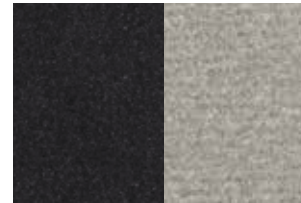

Jet or Cirrus



Jet

¹Black Hex Aluminium console finisher only available with Interior Black Pack

*Jet Morzine standard, Stone Morzine and Jet Suedecloth optional. Leather swatches shown, also available as an option when Extended Leather Pack is selected

SEAT WITH STITCH



Red with Jet

UPPER FACIA WITH STITCH

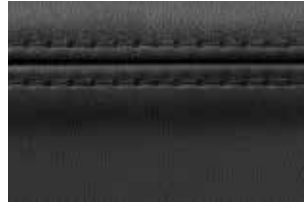

Jet with Jet

CONSOLE FINISHER

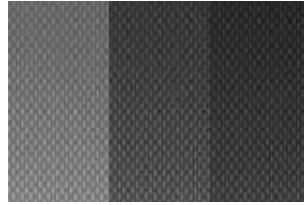

Light, Dark or Black Hex¹

HEADLINING*



Jet, Stone or Red[†]

CARPETS

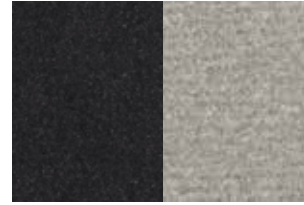

Jet or Cirrus

SEATBELTS



Jet or Red

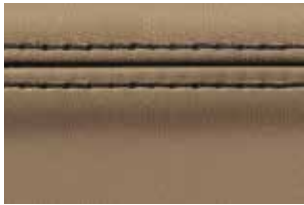

Camel with Jet

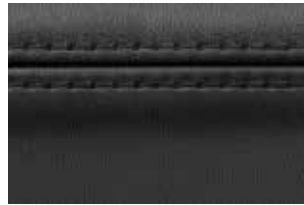

Jet with Jet

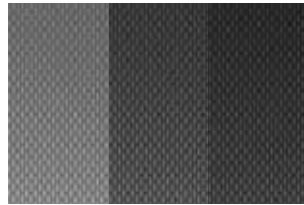

Light, Dark or Black Hex¹

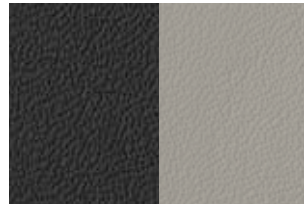

Jet or Stone



Jet, Cirrus or Camel



Jet or Camel

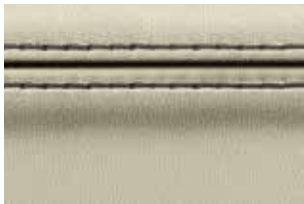

Ivory with Mineral



Mineral with Mineral



Light, Dark or Black Hex¹

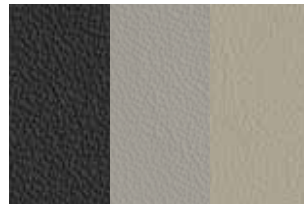

Jet, Stone or Ivory



Mineral or Cirrus



Jet

¹Black Hex Aluminium console finisher only available with Interior Black Pack

*Jet Morzine standard, Stone Morzine and Jet Suedecloth optional. Leather swatches shown, also available as an option when Extended Leather Pack is selected

[†]Red headlining available on Convertible only

PERFORMANCE SEATS IN PREMIUM LEATHER AND SUEDECLOTH WITH PREMIUM LEATHER AND SUEDECLOTH INTERIOR

OPTIONAL ON ALL MODELS



F-TYPE R with Jet Premium leather and Suedecloth Performance seats with Jet upper fascia and Cirrus stitch, Jet Suedecloth headlining with Dark Technical Weave console finisher and Jet carpets.

SEAT WITH STITCH



Jet with Cirrus

UPPER FACIA WITH STITCH



Jet with Cirrus

CONSOLE FINISHER

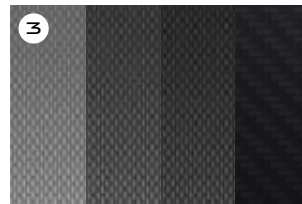

Light, Dark, Black Hex or Dark Technical Weave

HEADLINING

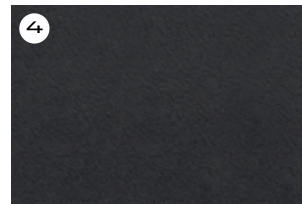

Jet Suedecloth

CARPETS

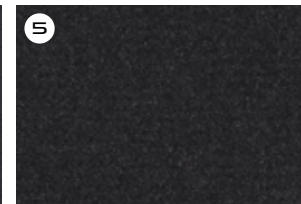

Jet

SEATBELTS



Jet

1. Seat with stitch - colour applies to seats, door trim inserts and grab handle.
2. Upper fascia with stitch - colour applies to dashboard, centre console armrest and upper door trims.
3. Console Finisher, dependent on model.

PERFORMANCE SEATS IN PREMIUM LEATHER AND PREMIUM LEATHER INTERIOR STANDARD ON F-TYPE R



SEAT WITH STITCH



Jet with Ivory

UPPER FACIA WITH STITCH



Jet with Ivory

CONSOLE FINISHER

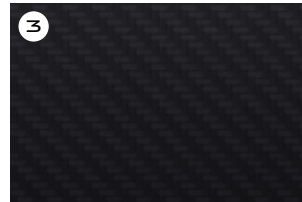

Dark Technical Weave

HEADLINING



Jet

CARPETS

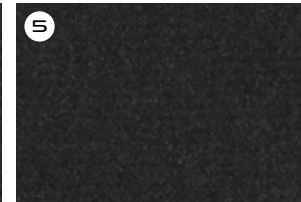

Jet

F-TYPE R with Jet Premium leather Performance seats with Jet upper facia and Ivory stitch, Jet Morzine headlining with Dark Technical Weave console finisher and Jet carpets.

1. Seat with stitch - colour applies to seats, door trim inserts and grab handle.
2. Upper facia with stitch - colour applies to dashboard, centre console armrest and upper door trims.

SEAT WITH STITCH

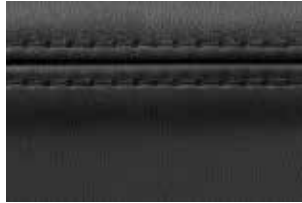

Jet with Jet

UPPER FACIA WITH STITCH

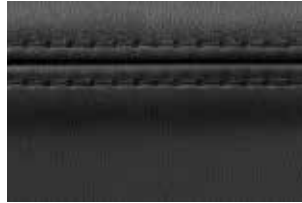

Jet with Jet

CONSOLE FINISHER

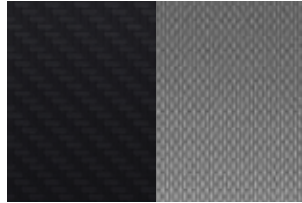

Dark Technical Weave
or Light Hex

HEADLINING



Jet or Stone

CARPETS



Jet

SEATBELTS

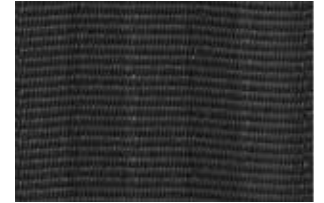

Jet



Jet with Ivory



Jet with Ivory

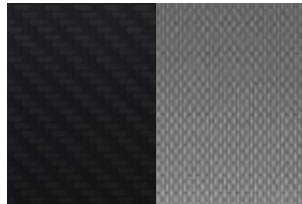

Dark Technical Weave
or Light Hex

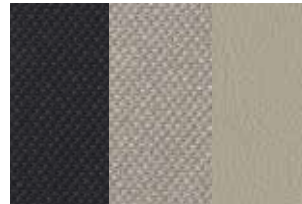

Jet, Stone or Ivory*

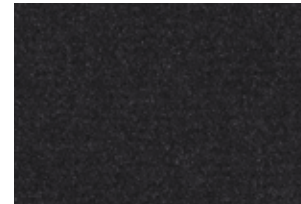

Jet



Jet



Jet with Red



Jet with Red

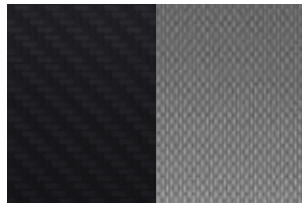

Dark Technical Weave
or Light Hex



Jet or Stone

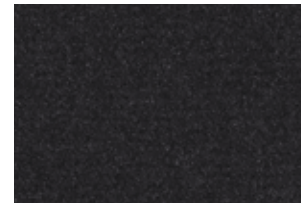

Jet



Jet or Red

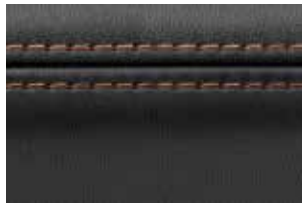

Jet with Firesand

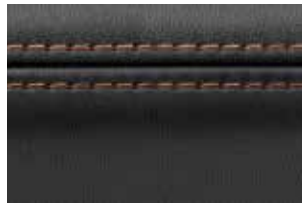

Jet with Firesand

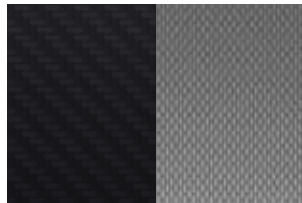

Dark Technical Weave
or Light Hex



Jet or Stone

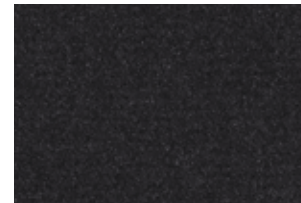

Jet



Jet

*Ivory not available if Glass Panoramic Roof is selected

PERFORMANCE SEATS IN PREMIUM LEATHER AND PREMIUM LEATHER INTERIOR STANDARD ON F-TYPE R



SEAT WITH STITCH

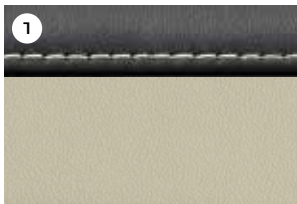

Jet and Ivory Duotone with Ivory

UPPER FACIA WITH STITCH



Jet with Ivory

CONSOLE FINISHER

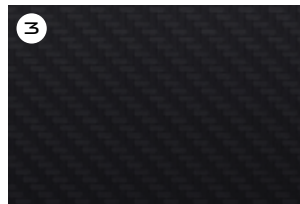

Dark Technical Weave

HEADLINING



Jet

CARPETS

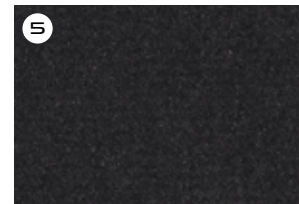

Jet

F-TYPE R with Jet and Ivory Duotone Premium leather Performance seats with Jet upper fascia and Ivory stitch, Jet Morzine headlining and Dark Technical Weave. Aluminium console finisher and Jet carpets.

1. Seat with stitch - colour applies to seats, door trim inserts and grab handle.

2. Upper fascia with stitch - colour applies to dashboard, centre console armrest and upper door trims.

DUOTONE SEAT WITH STITCH



Jet and Camel

UPPER FACIA WITH STITCH



Jet with Camel

CONSOLE FINISHER

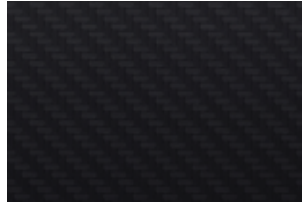

Dark Technical Weave

HEADLINING



Jet or Stone

CARPETS



Jet

SEATBELTS



Jet or Camel

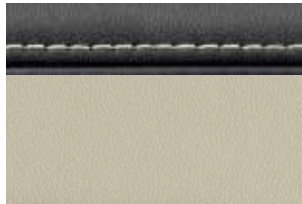

Jet and Ivory



Jet with Ivory

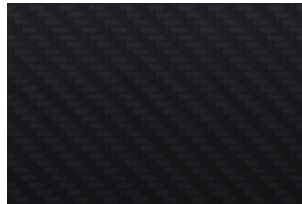

Dark Technical Weave

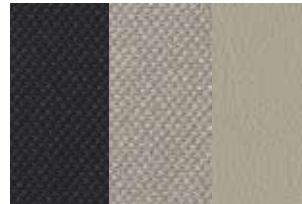

Jet, Stone or Ivory

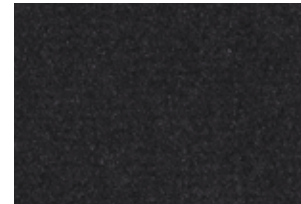

Jet



Jet

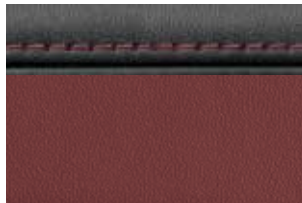

Jet and Red



Jet with Red

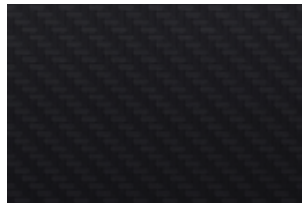

Dark Technical Weave



Jet or Stone

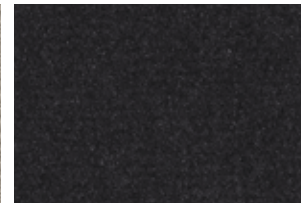

Jet



Jet or Red

ADDED ATTITUDE, ADDED OPTIONS

F-TYPE's strong visual assertiveness can be further enhanced thanks to the availability of two exciting options - **Design Pack** and **Black Pack**. The Design Pack is available on **F-TYPE**, **F-TYPE S** and **F-TYPE V8 S**. It features body-coloured sill extensions, front aerodynamic splitters and a Gloss Black rear valance and, on F-TYPE and F-TYPE S models only, a colour-keyed rear venturi. The Black Pack is available on all F-TYPE models, both Convertible and Coupé, and features a Gloss Black finish on the front grille surround, as well as to the bumper beam, bonnet louvres and front splitter. The Gloss Black finish also extends to the front outer meshes, side power vents, rear valance, the roll over protection bars for Convertible or window surrounds on Coupé.



DESIGN PACK*

1. Body coloured front bumper splitter 2. Body coloured aerodynamic splitters 3. Body coloured side sill extensions 4. Gloss Black rear valance 5. Body coloured rear bumper venturi

*Not available on F-TYPE R
†Content dependent upon model



INTERIOR BLACK PACK*

1. Gloss Black air vent surrounds and door switch pack surrounds **2.** Flat-bottomed Sports steering wheel with Gloss Black trim finisher **3.** Gloss Black Instrument Cluster Dial Rings **4.** Black Hex Aluminium console finisher



EXTERIOR BLACK PACK†

1. Gloss Black finish to front grille surround, bumper beam, front splitter, front outer meshes and rear valance **2.** Gloss Black bonnet louvres **3.** Gloss Black side power vents **4.** Gloss Black window surrounds (Coupé only) and Gloss Black Roll Over Protection Bars (Convertible only)

ACCESSORIES

A wide range of high quality accessories is available from your Jaguar dealer. They are all designed to complement your lifestyle, add further individuality or enhance practicality. For the full, extensive collection of F-TYPE accessories, please refer to the Specification and Price Guide.



SUEDECLOTH STEERING WHEEL WITH CARBON FIBRE CENTRE CONSOLE FINISHER

Enhance the vehicle's interior with the supple touch of the Suede Cloth Steering Wheel and the stylish look of the Carbon Fibre Centre Console Finisher.



CARBON FIBRE ENGINE COVER

Add a dynamic flair to your F-TYPE with this lightweight Carbon Fibre Engine Cover.



WIND DEFLECTOR

Reduce wind in the cabin with this easy to install, quick to remove, Wind Deflector.

CARBON FIBRE ROLL OVER PROTECTION BARS

Accentuate your F-TYPE's contemporary sporting style with these Carbon Fibre Roll Over Protection Bars.



**20" BLADE FORGED ALLOY
TECHNICAL GREY/CARBON FIBRE**

Add your own style to your F-TYPE with these striking forged 20 inch wheels. Featuring high-grade Carbon Fibre inserts and Jaguar's dynamic 'Blade' design.



CARBON FIBRE MIRROR COVERS

Accentuate the dynamic design of your F-TYPE's exterior mirrors and add further individuality to its sporting character.



CARBON FIBRE BONNET LOUVRES

Emphasise one of your F-TYPE's most distinctive features with these high-grade Carbon Fibre Bonnet Louvres.



CARBON FIBRE SIDE VENTS

Take F-TYPE's sporting credentials to another level with the addition of these Carbon Fibre Side Vents.



CARBON FIBRE FRONT SPLITTER BLADE

Give F-TYPE an even more assertive look with this performance-inspired Carbon Fibre Front Splitter Blade.



CARBON FIBRE REAR DIFFUSER

Make a bold exterior styling statement with this high grade Carbon Fibre Rear Diffuser featuring aero blades.



EXHAUST FINISHERS

Making an eye-catching, more individual styling statement, these bright polished Exhaust Finishers replace the twin exhaust outlet on F-TYPE V6 models.



SKI CARRIER

Carry up to 2 pairs of skis safely and securely on this lockable Ski Carrier. Designed to minimise wind noise and air resistance, the carrier requires no auxiliary lighting or number plate and fits/removes in minutes.



5-PIECE LUGGAGE SET

Designed for the exact dimensions of F-TYPE's boot space, this high-quality, 5-piece Luggage Set looks good anywhere and maximises the car's carrying capacity.





IMPORTANT NOTICE

Jaguar Land Rover Limited is constantly seeking ways to improve the specification, design and production of its vehicles and alterations take place continually. Whilst every effort is made to produce up-to-date literature, this brochure should not be regarded as an infallible guide to current specifications, nor does it constitute an offer for the sale of any particular vehicle. Distributors and dealers are not agents of Jaguar Land Rover Limited by any express or implied undertaking or representation. Comparisons are based on manufacturer's own data and testing.

ENVIRONMENTAL INNOVATION AT JAGUAR

Jaguar is proud to continue the company's tradition with its approach to Environmental Innovation. From the choice of lightweight materials and lean production methods to the efficiency of its engines and designs, Jaguar is committed to operating as a more sustainable business and reducing its overall environmental impact.

Jaguar's flagship XJ model was the first in the company to achieve ISO 14040, the international standard for vehicle life cycle assessment. This certification measures the environmental impact of XJ from component material sourcing and manufacturing process, through driving 200,000km, to final disposal. But that's not all. Every new Jaguar is designed to be 85% recyclable and reusable, in addition 95% recoverable and reusable, with 10% specifically for energy recovery.

The XJ, F-TYPE and XK's innovative use of lightweight aluminium, which incorporates up to 50% recycled material from the manufacturing process of the body structures, provides considerable performance benefits. This includes improved fuel consumption and less CO₂ emissions associated with lighter structures as well as the dynamic performance inherent in its weight saving design.

Jaguar is committed to reducing dependency on fossil fuels, using fewer resources and creating less waste as part of our approach to sustainability excellence.

The company plan includes 25% reduction targets in operating and tailpipe CO₂ emissions, waste to landfill, logistics efficiencies (15%) and water consumption (10%), all based on per vehicle built since 2007. In addition the manufacturing assembly CO₂ emissions of each Jaguar built in the UK since 2009 is 100% offset. For each tonne of CO₂ emitted in the assembly process, Jaguar invests in projects that reduce an equivalent tonne of CO₂ elsewhere.

Taking into account the company's global sales growth and increased investment in more efficient operating facilities, we are proud to have delivered and in some cases exceeded our Environmental Innovation targets as planned for 2012. And we are on track to meet our 25% reduction in joint European fleet average tailpipe CO₂ emissions by 2015.

Looking forward, we have developed our 2020 vision for sustainable business growth that focuses on continued improvements in tailpipe CO₂ emissions, operational carbon neutrality and zero waste.

To date the company has offset over 6 million tonnes of CO₂, provided over 4,000 direct jobs in 60 emissions reductions projects in 17 countries and improved the lives of over 1 million people in our global cook stoves emissions reduction programme.

But it doesn't stop there. Our manufacturing facilities have been certified to ISO14001 since 1998 and we are credited to Platinum Plus level in the UK's Business in the Community Corporate Responsibility Index.

VEHICLE SHOWN: F-TYPE R IN STRATUS GREY WITH OPTIONAL STORM ALLOY WHEELS AND CARBON CERAMIC BRAKES

'Trifield™' and the 'three fields' device are trademarks of Trifield Productions Ltd.
iPod, iPod touch and iPad are trademarks of Apple Inc., registered in the U.S. and other countries.



Go behind the scenes at Jaguar.
Download the Jaguar Magazine app
- just search "Jaguar Magazine"
in the App Store™ or Google Play.



Jaguar Land Rover Limited,
Registered Office: Abbey Road, Whitley,
Coventry, CV3 4LF, United Kingdom
Registered in England Number: 1672070
jaguar.com





JAGUAR.COM

JAGUAR