

XJ

SPECIFICATION AND PRICE GUIDE





EXTRAORDINARY LUXURY

XJ is passion in motion, a dramatic combination of beauty, luxury and sheer exhilarating power.

Outside, the sweep of its streamlined roof is fashioned to slice air like a blade. Inside, its sensuous cabin is crafted to pamper, built for stretching out and relaxing. Carefully chosen materials are meticulously handcrafted to provide the utmost comfort and delight the senses. And with its strong lightweight aluminium body, the XJ provides agility and superlative handling. This combined with the anticipatory systems and technology allows the XJ to react to road conditions and other cars alike.

The following pages provide details and specifications for the XJ range. In-depth descriptions of key features and available options are designed to give you all the information you require to create the XJ that's just right for you. Please use this guide in conjunction with the XJ main brochure's colour and trim sections for illustrations of colour and materials available.

Alternatively, you may prefer to use the XJ configurator at jaguar.co.uk to specify and price your new car.

ENGINE CHOICES	4
DIMENSIONS AND WEIGHTS	5
MODEL PRICES	6
STANDARD AND OPTIONAL FEATURES	7

XJ LUXURY	
Key Features and Option Prices	11
Alloy Wheel Choices	12
Colour and Trim Choices	13

XJ PREMIUM LUXURY	
Key Features and Option Prices	14
Alloy Wheel Choices	16
Colour and Trim Choices	17

XJ PORTFOLIO	
Key Features and Option Prices	18
Alloy Wheel Choices	19
Colour and Trim Choices	20

XJ SUPERSPORT	
Key Features and Option Prices	21
Alloy Wheel Choices	22
Colour and Trim Choices	23

XJR	
Key Features and Option Prices	24
Colour and Trim Choices	25

XJ ACCESSORIES	26
XJ GLOSSARY	34

ENGINE CHOICES

ENGINES		JAGUAR 3.0 LITRE V6 275 TURBOCHARGED DIESEL	JAGUAR 3.0 LITRE V6 340 SUPERCHARGED PETROL	JAGUAR 5.0 LITRE V8 510 SUPERCHARGED PETROL	JAGUAR 5.0 LITRE V8 550 SUPERCHARGED PETROL
Capacity	cc	2993	2995	5000	5000
Maximum power	EEC-PS (kW)	275 (202)	340 (250)	510 (375)	550 (405)
@rev/min		4,000	6,500	6,000 - 6,500	6,000 - 6,500
Maximum torque	EEC-Nm (lb.ft.)	600 (443)	450 (332)	625 (461)	680 (502)
@rev/min		2,000	3,500 - 5,000	2,500 - 5,500	2,500 - 5,500
Transmission		8-speed automatic	8-speed automatic	8-speed automatic	8-speed automatic
PERFORMANCE					
0-60 mph	seconds	6.0	5.7	4.7	4.4
0-100 km/h	seconds	6.4	5.9	4.9	4.6
Top speed	mph (km/h)	155 (250) limited	155 (250) limited	155 (250) limited	174 (280) limited
FUEL CONSUMPTION – STANDARD WHEELBASE					
Urban	mpg (l/100km)	39.8 (7.1)	20.9 (13.5)	–	16.7 (16.9)
Extra Urban	mpg (l/100km)	51.4 (5.5)	38.2 (7.4)	–	32.8 (8.6)
Combined	mpg (l/100km)	46.3 (6.1)	29.4 (9.6)	–	24.4 (11.6)
Carbon dioxide emissions	g/km	159	224	–	270
Tank capacity	gals (ltr) approx.	18 (82)	18 (82)	–	18 (82)
FUEL CONSUMPTION – LONG WHEELBASE					
Urban	mpg (l/100km)	36.7 (7.7)	20.9 (13.5)	17.0 (16.9)	–
Extra Urban	mpg (l/100km)	50.4 (5.6)	38.2 (7.4)	32.8 (8.6)	–
Combined	mpg (l/100km)	44.8 (6.3)	29.4 (9.6)	24.4 (11.6)	–
Carbon dioxide emissions	g/km	167	224	270	–
Tank capacity	gals (ltr) approx.	18 (82)	18 (82)	18 (82)	–
ENGINE AVAILABILITY					
XJ Luxury		●	–	–	–
XJ Premium Luxury		●	●	–	–
XJ Portfolio		●	●	–	–
XJ Supersport		–	–	●	–
XJR		–	–	–	●

● Standard — Not available

The figures provided are as a result of official manufacturer's tests in accordance with EU legislation. A vehicle's actual fuel consumption may differ from that achieved in such tests and these figures are for comparative purposes only. Please consult your local Jaguar dealer for details.

DIMENSIONS AND WEIGHTS

STANDARD WHEELBASE		JAGUAR 3.0 LITRE V6 275 TURBOCHARGED DIESEL	JAGUAR 3.0 LITRE V6 340 SUPERCHARGED PETROL	JAGUAR 5.0 LITRE V8 510 SUPERCHARGED PETROL	JAGUAR 5.0 LITRE V8 550 SUPERCHARGED PETROL
Overall length	mm	5,127	5,127	—	5,127
Overall width (inc. mirrors)	mm	2,105	2,105	—	2,105
Overall width (exc. mirrors)	mm	1,899	1,899	—	1,899
Overall height (inc. antenna)	mm	1,456	1,456	—	1,456
Wheelbase	mm	3,032	3,032	—	3,032
Front track	mm	1,626	1,626	—	1,626
Rear track	mm	1,604	1,604	—	1,604
Turning circle diameter (kerb to kerb)	m (ft.in)	11.9 (39.0)	11.9 (39.0)	—	11.9 (39.0)
Boot volume with tyre repair system	litres - VDA (cu.ft.)	520 (18.4)	520 (18.4)	—	520 (18.4)
Weight	kg (lbs)	1,772 (3,907)	1,748 (3,854)	—	1,873 (4,129)
Gross vehicle weight	kg (lbs)	2,370 (5,225)	2,350 (5,181)	—	2,400 (5,291)
LONG WHEELBASE					
Overall length	mm	5,252	5,252	5,252	—
Overall width (inc. mirrors)	mm	2,105	2,105	2,105	—
Overall width (exc. mirrors)	mm	1,899	1,899	1,899	—
Overall height	mm	1,457	1,457	1,457	—
Wheelbase	mm	3,157	3,157	3,157	—
Front track	mm	1,626	1,626	1,626	—
Rear track	mm	1,604	1,604	1,604	—
Turning circle diameter (kerb to kerb)	m (ft.in)	12.3 (40.4)	12.3 (40.4)	12.3 (40.4)	—
Boot volume with tyre repair system	litres - VDA (cu.ft.)	520 (18.4)	520 (18.4)	520 (18.4)	—
Weight	kg (lbs)	1,850 (4,079)	1,761 (3,882)	1,881 (4,147)	—
Gross vehicle weight	kg (lbs)	2,450 (5,401)	2,400 (5,291)	2,430 (5,357)	—

— Not available

MODEL PRICES

		JAGUAR 3.0 LITRE V6 275 TURBOCHARGED DIESEL	JAGUAR 3.0 LITRE V6 340 SUPERCHARGED PETROL	JAGUAR 5.0 LITRE V8 510 SUPERCHARGED PETROL	JAGUAR 5.0 LITRE V8 550 SUPERCHARGED PETROL
XJ LUXURY					
Standard Wheelbase	List Price	£46,766.67	—	—	—
	VAT	£9,353.33	—	—	—
	Retail Price	£56,120.00	—	—	—
	OTR Price	£56,865.00	—	—	—
Long Wheelbase	List Price	£49,266.67	—	—	—
	VAT	£9,853.33	—	—	—
	Retail Price	£59,120.00	—	—	—
	OTR Price	£59,975.00	—	—	—
XJ PREMIUM LUXURY					
Standard Wheelbase	List Price	£49,933.33	£53,995.83	—	—
	VAT	£9,986.67	£10,799.17	—	—
	Retail Price	£59,920.00	£64,795.00	—	—
	OTR Price	£60,665.00	£65,985.00	—	—
Long Wheelbase	List Price	£52,433.33	£56,620.83	—	—
	VAT	£10,486.67	£11,324.17	—	—
	Retail Price	£62,920.00	£67,945.00	—	—
	OTR Price	£63,775.00	£69,135.00	—	—
XJ PORTFOLIO					
Standard Wheelbase	List Price	£55,933.33	£60,204.17	—	—
	VAT	£11,186.67	£12,040.83	—	—
	Retail Price	£67,120.00	£72,245.00	—	—
	OTR Price	£67,865.00	£73,435.00	—	—
Long Wheelbase	List Price	£58,433.33	£62,704.17	—	—
	VAT	£11,686.67	£12,540.83	—	—
	Retail Price	£70,120.00	£75,245.00	—	—
	OTR Price	£70,975.00	£76,435.00	—	—
XJ SUPERSPORT					
Long Wheelbase	List Price	—	—	£78,529.17	—
	VAT	—	—	£15,705.83	—
	Retail Price	—	—	£94,235.00	—
	OTR Price	—	—	£95,870.00	—
XJR					
Standard Wheelbase	List Price	—	—	—	£75,612.50
	VAT	—	—	—	£15,122.50
	Retail Price	—	—	—	£90,735.00
	OTR Price	—	—	—	£92,370.00

— Not available

The estimated 'On the Road' (OTR) retail price includes items such as delivery to dealer, Vehicle Excise Duty, Vehicle First Registration Fee, estimated cost of Number Plates and VAT (at 20%). Accessories requiring dealer fit may incur a labour charge. We recommend you contact your dealer for more details.

COMPARE STANDARD AND OPTIONAL FEATURES

	XJ LUXURY	XJ PREMIUM LUXURY	XJ PORTFOLIO	XJ SUPERSPORT	XJR
POWERTRAIN AND DRIVING DYNAMICS					
8-speed electronic automatic transmission with Jaguar Sequential Shift™	●	●	●	●	●
JaguarDrive Control™ with Winter Mode and Dynamic Mode	●	●	●	●	●
JaguarDrive Selector™	●	●	●	●	●
Dynamic Stability Control (DSC) with Trac DSC mode	●	●	●	●	●
Active Differential ¹	—	—	—	●	●
Electric Parking Brake (EPB) - drive away release	●	●	●	●	●
Adaptive Dynamics	●	●	●	●	●
Cruise Control with Automatic Speed Limiter (ASL)	●	●	●	●	●
Intelligent Stop/Start system	●	●	●	●	●
Emergency Brake Assist (EBA)	●	●	●	●	●
Adaptive Cruise Control (ACC) with Forward Alert and Advanced Emergency Brake Assist	○	○	○	○	○
Red Painted brake calipers with Jaguar script	—	P	P	P	●
Carbon fibre engine cover	—	—	—	—	○
SAFETY AND SECURITY					
Jaguar smart key system™ - keyless start and entry	●	●	●	●	●
Rear parking aid with Touch-screen visual indicator	●	●	●	●	●
Front parking aid with Touch-screen visual indicator	○	●	●	●	●
Reverse park camera with guidance	P	○	●	●	●
Pedestrian Contact Sensing System™ - Automatically deployable bonnet system	●	●	●	●	●
3-flash lane change indicators	●	●	●	●	●
Remote control central locking with deadlocking and drive-away locking function	●	●	●	●	●
Power boot lid (open and close)	●	●	●	●	●
Airbags front and side (driver and front passenger)	●	●	●	●	●
Side curtain airbags	●	●	●	●	●
Front seats - whiplash protection system	●	●	●	●	●
Seat belt reminder (front and rear)	●	●	●	●	●
ISOFIX anchor points for rear child seats	●	●	●	●	●
Blind Spot Monitor	○	○	○	○	○
Tyre Pressure Monitoring System (TPMS) ²	○	○	●	●	●

● Standard ○ Option — Not available P Option as part of pack

¹Only available on 5.0 litre V8 Supercharged petrol engine ²Not available with 18" Meru alloy wheels ³19" space saver spare wheel on Supersport and XJR

Please consult your local Jaguar dealer for details.

	XJ LUXURY	XJ PREMIUM LUXURY	XJ PORTFOLIO	XJ SUPERSPORT	XJR
EXTERIOR FEATURES					
Twin tailpipes with chrome finishers	●	●	●	●	—
Sports exhaust with quad tailpipes	—	—	—	—	—
Heated rear window with timer	●	●	●	●	●
Heated front screen with timer	●	●	●	●	●
Rain sensing windscreen wipers	●	●	●	●	●
Bi-function HID Xenon headlamps with washers and front LED signature lights	●	●	—	—	—
Bi-function HID Xenon headlamps with Adaptive Front Lighting, cornering lamps and intelligent high beam	○	○	●	●	●
LED tail lamps	●	●	●	●	●
Solar attenuating, hydrophobic and acoustically laminated glass	●	●	●	●	●
Exterior mirrors with electric adjustment, heated, power folding, auto dimming with puddle lamps and memory function	●	●	●	●	●
18" space saver spare wheel (required with 20" wheel options) ³	○	○	●	—	—
19" space saver spare wheel	—	—	—	●	●
Approach illumination (automatic via remote)	●	●	●	●	●
Bonnet louvres	—	—	—	—	●
Front splitter	—	P	P	P	●
Rear spoiler	—	P	P	P	●
Unique side sills	—	—	—	—	●
Soft door close	●	●	●	●	●

	XJ LUXURY	XJ PREMIUM LUXURY	XJ PORTFOLIO	XJ SUPERSPORT	XJR
INTERIOR THEMES					
Bond grain leather seats	●	—	—	—	—
Bond grain stitched and tailored upper fascia, door top roll and armrest and centre console lid	●	—	—	—	—
Soft grain leather seats	—	●	—	—	—
Soft feel upper fascia, door top roll, armrests and centre console lid	—	●	—	—	—
Soft grain leather on upper fascia, door top roll, door armrest and centre console lid	—	○	—	—	—
Soft grain leather seats with contrast stitch and piping (with headrest leaper)	—	—	●	—	—
Soft grain leather sports seats with 'R' logo	—	—	—	—	●
Soft grain leather on upper fascia, door top roll, door pannier, door armrest, seat valance, centre console lid and end cap with twin needle stitch	—	—	—	●	—
Semi-aniline leather seats with contrast stitch and piping (with headrest leaper)	—	—	P	●	P
Soft grain leather stitched and tailored upper fascia, door top roll, door pannier, door armrest and centre console lid with twin needle stitching	—	—	●	—	●
Morzine headlining	●	●	—	—	—
Suedecloth headlining	—	—	●	—	●
Soft grain leather headlining	—	—	○	●	○
Carpet mat set (front and rear)	●	●	—	—	—
Premium carpet mat set (front and rear)	—	—	●	—	●
Logo Premium carpet mat set (front and rear)	—	—	—	●	—
Stainless steel sill tread plates – Debossed Jaguar script	●	●	●	—	●
Illuminated stainless steel tread plates	—	P	P	●	—
Bright finish accelerator and brake pedals	—	P	P	●	●

	XJ LUXURY	XJ PREMIUM LUXURY	XJ PORTFOLIO	XJ SUPERSPORT	XJR
INTERIOR FEATURES					
Electric front seat adjustment (8x8 way) including fore/aft, cushion height, squab recline and cushion tilt. Heated front and rear seats	●	—	—	—	—
Electric front seat adjustment (12x12 way) including fore/aft, cushion height, squab recline, cushion tilt and 4-way lumbar adjust. Heated front and rear seats. Driver's 3-position seat memory	○	●	—	—	—
Electric front seat adjustment (12x12 way) including fore/aft, cushion height, squab recline, cushion tilt and 4-way lumbar adjust. Heated and cooled front and rear seats. Driver's 3-position seat memory	—	○	—	—	—
Electric front seat adjustment (18x18 way) including fore/aft, cushion height, squab recline, cushion tilt, 4-way lumbar, adjustable bolsters, cushion extension and powered headrests. Heated and cooled front and rear seats. Driver's and front seat passenger's 3-position seat memory	—	—	●	—	●
Electric front seat adjustment (20x20 way) including fore/aft, cushion height, squab recline, cushion tilt, 4-way lumbar, adjustable bolsters, cushion extension and powered headrests. 5 massage functions with 5 intensity settings. Heated and cooled front and rear seats. Driver's and front seat passenger's 3-position seat memory	—	○	○	●	—
Front and rear electric windows with one-touch open/close and anti-trap	●	●	●	●	●
Panoramic glass roof with electric blinds	●	●	●	●	●
Steering column with electric adjustment for height and reach	●	●	●	●	●
Auto-dimming interior rear view mirror	●	●	●	●	●
Front centre console with illuminated stowage, auxiliary power socket and armrest	●	●	●	●	●
3-spoke soft grain leather steering wheel with Jaguar Sequential Shift™ paddles and remote controls for audio system, cruise control, Bluetooth® telephone connectivity and Interactive Voice	●	—	—	—	—
3-spoke soft grain leather heated steering wheel with Jaguar Sequential Shift™ paddles and remote controls for audio system, cruise control, Bluetooth® telephone connectivity and Interactive Voice	○	●	●	●	—
3-spoke wood and soft grain leather heated steering wheel with Jaguar Sequential Shift™ paddles and remote controls for audio system, cruise control, Bluetooth® telephone connectivity and Interactive Voice ¹	—	○	○	○	—
3-spoke soft grain leather heated steering wheel with 'R' logo, Jaguar Sequential Shift™ paddles and remote controls for audio system, cruise control, Bluetooth® telephone connectivity and Interactive Voice	—	—	—	—	●

● Standard ○ Option — Not available P Option as part of pack

¹Wood and leather steering wheel is only available with gloss wood veneers

Please consult your local Jaguar dealer for details.

COMPARE STANDARD AND OPTIONAL FEATURES

	XJ LUXURY	XJ PREMIUM LUXURY	XJ PORTFOLIO	XJ SUPERSPORT	XJR
INTERIOR FEATURES (CONTINUED)					
Twin front cup holders	●	●	●	●	●
Sun visor – driver and front passenger, with illuminated vanity mirrors	●	●	●	●	●
Rear coat hooks	●	●	●	●	●
Front and rear courtesy footwell lights	●	●	●	●	●
Phosphor blue halo illumination and interior mood lighting	●	●	●	●	●
JaguarSense™ – glovebox opening	●	●	●	●	●
JaguarSense™ – overhead light console operation (front)	●	●	●	●	●
Driver's foot rest	●	●	●	●	●
Intaglio ('Jaguar' script)	●	●	●	–	–
Intaglio ('Supersport' script)	–	–	–	●	–
Intaglio ('XJR')	–	–	–	–	●
Rear seats – centre armrest with twin cup holders	●	●	●	●	●
Jaguar premium analogue clock	●	●	●	●	●
Dual zone automatic climate control with air filtration, humidity sensing and dual zone temperature control for driver and front passenger	●	●	–	–	–
Four zone automatic climate control with air filtration, humidity sensing and four zone temperature control for driver, front passenger and independent control for left and right rear passengers (standard on Long Wheelbase models)	○	○	●	●	●
Air quality sensing with auto recirculation	○	○	○	○	○
Garage door opener with overhead remote control	○	○	○	○	○
Privacy glass (standard on Long Wheelbase models)	○	○	○	○	○
Front ashtray and cigar lighter	○	○	○	○	○
Electric rear window sunblind (standard on Long Wheelbase models)	○	○	○	○	○
LED rear reading lights	○	○	○	○	○
Trunk runners	○	○	○	○	○

	XJ LUXURY	XJ PREMIUM LUXURY	XJ PORTFOLIO	XJ SUPERSPORT	XJR
MULTIMEDIA					
Virtual Instruments, 8 inch Touch-screen, single slot CD/DVD, Interactive Voice, Interactive Controls, Media Hub including Front Media Interface and Bluetooth audio streaming	●	●	●	●	●
Navigation system with HDD mapping	●	●	●	●	●
Jaguar Audio System – 250W with single slot CD/DVD	●	–	–	–	–
Meridian Audio System – 380W with single slot CD/DVD	○	●	–	–	–
Meridian Surround Audio System – 825W with single slot CD/DVD	○	○	●	●	●
Digital Audio Broadcasting (DAB) radio receiver	●	●	●	●	●
Television-Digital Tuner	○	○	○	●	●
Dual View functionality and one set of WhiteFire® digital wireless headphones	○	○	○	●	●
Rear Seat Entertainment – 8 inch dual LCD screens (mounted in rear of front headrests) with Rear media Interface and Touch-screen remote control and two sets of WhiteFire® digital wireless headphones. Not available with Jaguar Audio System	○	○	○	●	–
Interactive Voice™. Front voice control of Audio, Bluetooth® 2.0 connectivity and Navigation	●	●	●	●	●

● Standard ○ Option – Not available

Please consult your local Jaguar dealer for details.

COMPARE STANDARD AND OPTIONAL FEATURES

	XJ LUXURY	XJ PREMIUM LUXURY	XJ PORTFOLIO	XJ SUPERSPORT	XJR
LONG WHEELBASE ADDITIONAL FEATURES					
Rear Seat Entertainment - 10.2 inch dual LCD screens (mounted on the rear of front seats) with Rear Media Interface and Touch-screen remote control and two sets of WhiteFire™ digital wireless headphones.	—	P	P	P	—
Illuminated rear vanity mirrors	●	●	●	●	—
Privacy glass	●	●	●	●	—
Delete privacy glass	NCO	NCO	NCO	NCO	—
Electric rear window sunblind	●	●	●	●	—
Four zone automatic climate control with air filtration, humidity sensing and four zone temperature control for driver, front passenger and independent control for left and right rear passengers	●	●	●	●	—
Manual rear side window blinds	●	●	●	●	—
Electric rear side window blinds	○	○	○	○	—

	XJ LUXURY	XJ PREMIUM LUXURY	XJ PORTFOLIO	XJ SUPERSPORT	XJR
PACKS					
Parking Aid Pack - Front parking aid with Touch-screen visual indicator and Reverse park camera with guidance	○	—	—	—	—
Illumination Pack - Phosphor blue illumination in front and rear air vents, illuminated tread plates and boot latch finisher	—	○	○	—	○
Sport Exterior Pack - Front aero splitter, rear decklid spoiler, Gloss Black radiator grille with chrome surround, Gloss Black lower mesh, Gloss Black mesh in side power vent, Red painted brake calipers with Jaguar script and a choice of 20" Venom alloy wheel in sparkle finish or 20" Mataiva alloy wheels ¹	—	○	○	○	—
Sport Interior Pack - Features upgraded 18/18 way Sports seats and interior trim (as detailed on the Colour and Trim pages) and four zone automatic climate control ²	—	○	○	—	—
Speed Pack - Maximum speed increases from 155mph to 174mph. Also includes revised exterior elements - front aero splitter, rear decklid spoiler, Gloss Black radiator grille with chrome surround, Gloss Black lower mesh, Gloss Black mesh in side power vent, Red painted brake calipers with Jaguar script and a choice of 20" Venom alloy wheels in sparkle finish or 20" Mataiva alloy wheels ²	—	—	—	○	—

● Standard ○ Option — Not available NCO No cost option P Option as part of pack

¹20" Mataiva alloy wheels only available on Supersport

²Not available with Rear Seat Entertainment

Please consult your local Jaguar dealer for details.

LUXURY

KEY FEATURES

Available with Jaguar 3.0 Litre V6 275 Turbocharged Diesel engine
 Bond grain leather seats with driver's and passenger's electric adjustment (8x8 way)
 Heated front and rear seats
 19" Aleutian alloy wheels
 Satin Rosewood veneer
 Jaguar Audio System - 250W with single slot CD/DVD
 Digital Audio Broadcasting (DAB) radio receiver

Heated front screen with timer
 Dual zone automatic climate control with air filtration, humidity sensing and dual zone temperature control for driver, front passenger and independent control for left and right rear passengers
 Four zone automatic climate control with air filtration, humidity sensing and four zone temperature control for driver, front passenger and independent control for left and right rear passengers (standard on Long Wheelbase)
 Soft door close
 Jaguar smart key system™ - keyless start and entry

OPTIONAL FEATURES





POWERTRAIN AND DRIVING DYNAMICS	Retail Price
Adaptive Cruise Control (ACC) with Forward Alert and Advanced Emergency Brake Assist	£1,275.00
SAFETY AND SECURITY	
Blind Spot Monitor	£460.00
Tyre Pressure Monitoring System (TPMS) ¹	£410.00
Front parking aid with Touch-screen visual indicator	£205.00
EXTERIOR FEATURES	
Bi-function HID Xenon headlamps with Adaptive Front Lighting, cornering lamps and intelligent high beam	£860.00
18" space saver spare wheel (required with 20" wheel options)	£130.00
LONG WHEELBASE ADDITIONAL FEATURES	Retail Price
Electric rear side window blinds	£500.00
Delete privacy glass	NCO
MULTIMEDIA	
Meridian Audio System - 380W with single slot CD/DVD	£590.00
Meridian Surround Audio System - 825W with single slot CD/DVD	£1,580.00
Television - Digital Tuner	£900.00
Dual View functionality and one set of WhiteFire® digital wireless headphones	£1,900.00
Rear Seat Entertainment - 8 inch dual LCD screens (mounted in rear of front headrests) with Rear media Interface and Touch-screen remote control and two sets of WhiteFire® digital wireless headphones. Not available with Jaguar Audio System	£3,110.00





INTERIOR FEATURES	Retail Price
Upgrade to 12x12 way adjustable seats including driver's and passenger's 4-way lumbar support and driver's memory	£280.00
Four zone automatic climate control with air filtration, humidity sensing and four zone temperature control for driver, front passenger and independent control for left and right rear passengers (standard on Long Wheelbase)	£510.00
3-spoke soft grain leather heated steering wheel with Jaguar Sequential Shift™ paddles and remote controls for audio system, cruise control, Bluetooth® telephone connectivity and Interactive Voice	£240.00
Air quality sensing with auto recirculation	£50.00
Garage door opener with overhead remote control	£305.00
Privacy glass (standard on Long Wheelbase)	£255.00
Front ashtray and lighter	NCO
Electric rear window sunblind (standard on Long Wheelbase)	£305.00
LED rear reading lights	£200.00
Trunk runners	£200.00
PACKS	Retail Price
Parking Aid Pack - Front parking aid with Touch-screen visual indicator and Reverse park camera with guidance	£410.00

NCO No Cost Option
¹Not available with 18" Meru alloy wheels
 Please consult your local Jaguar dealer for details.

LUXURY

ALLOY WHEEL CHOICES

	STANDARD	OPTIONAL	OPTIONAL	OPTIONAL
				
	19" ALEUTIAN	18" MERU	19" TOBA	19" TOBA POLISHED
FRONT	9.0J x 19"	8.0J x 18"	9.0J x 19"	9.0J x 19"
REAR	10.0J x 19"	9.0J x 18"	10.0J x 19"	10.0J x 19"
OPTION PRICE	—	NCO	£510.00	£1,530.00

	OPTIONAL	OPTIONAL	OPTIONAL	OPTIONAL
				
	20" KASUGA	20" KASUGA POLISHED	20" ORONA	20" ORONA POLISHED
FRONT	9.0J x 20"	9.0J x 20"	9.0J x 20"	9.0J x 20"
REAR	10.0J x 20"	10.0J x 20"	10.0J x 20"	10.0J x 20"
OPTION PRICE	£1,020.00	£2,040.00	£1,020.00	£2,040.00

NCO No Cost Option
 All 20" alloy wheels require optional 18" space saver spare wheel

LUXURY

COLOUR AND TRIM CHOICES

EXTERIOR COLOURS

Standard

Ebony
Polaris White

Optional

Premium	Cashmere	£790.00
	Caviar	
	Rhodium Silver	
	Carnelian Red	
	Satellite Grey	
	Stratus Grey	
	Ultimate Black	
Race Inspired	Lunar Grey	
	British Racing Green	£1,490.00
	Italian Racing Red	
Special	Black Amethyst	£1,490.00

INTERIOR COLOUR COMBINATIONS

SEAT	STITCH	UPPER FACIA	HEADLINING
Bond grain leather		Bond grain leather	Morzine
Jet	Jet	Jet	Ivory
Cashew	Cashew	Truffle	Ivory

VENEERS

Standard

Satin Rosewood

Optional

Piano Black	£1,275.00
Carbon Fibre	£1,275.00
Gloss Burr Walnut	£205.00

Please consult your local Jaguar dealer for details.

PREMIUM LUXURY

KEY FEATURES

Available with Jaguar 3.0 Litre V6 275 Turbocharged Diesel and 3.0 Litre V6 340 Supercharged Petrol engines

Soft grain leather seats with driver's and passenger's electric adjustment (12x12 way)

Driver's 3 position seat memory

Heated front and rear seats

19" Toba alloy wheels

Gloss Burr Walnut veneer

Front parking aid with Touch-screen visual indicator

Jaguar smart key system™ - keyless start and entry

Soft door close

3-spoke soft grain leather heated steering wheel

Meridian Audio System - 380W with single slot CD/DVD

Digital Audio Broadcasting (DAB) radio receiver

Heated front screen with timer

OPTIONAL FEATURES

POWERTRAIN AND DRIVING DYNAMICS	Retail Price
Adaptive Cruise Control (ACC) with Forward Alert and Advanced Emergency Brake Assist	£1,275.00
SAFETY AND SECURITY	
Blind Spot Monitor	£460.00
Tyre Pressure Monitoring System (TPMS) ¹	£410.00
Reverse park camera with guidance	£235.00
EXTERIOR FEATURES	
Bi-function HID Xenon headlamps with Adaptive Front Lighting, cornering lamps and intelligent high beam	£860.00
18" space saver spare wheel (required with 20" wheel options)	£130.00

LONG WHEELBASE ADDITIONAL FEATURES	Retail Price
Delete privacy glass	NCO
Electric rear side window blinds	£500.00
MULTIMEDIA	
Meridian Surround Audio System - 825W with single slot CD/DVD	£990.00
Television - Digital Tuner	£900.00
Dual View functionality and one set of WhiteFire® digital wireless headphones	£1,900.00
Rear Seat Entertainment - 8 inch dual LCD screens (mounted in rear of front headrests) with Rear media Interface and Touch-screen remote control and two sets of WhiteFire® digital wireless headphones. Not available with Jaguar Audio System	£1,530.00

NCO No Cost Option

¹Not available with 18" Meru alloy wheels

Please consult your local Jaguar dealer for details.

OPTIONAL FEATURES [CONTINUED]

INTERIOR FEATURES	Retail Price
Soft grain leather on upper fascia, door top roll, door armrest and centre console lid	£480.00
Electric front seat adjustment (12x12 way) including fore/aft, cushion height, squab recline, cushion tilt and 4-way lumbar adjust. Heated and cooled front and rear seats. Driver's 3-position seat memory ¹	£960.00
Electric front seat adjustment (20x20 way) including fore/aft, cushion height, squab recline, cushion tilt, 4-way lumbar, adjustable bolsters, cushion extension and powered headrests. 5 massage functions with 5 intensity settings. Heated and cooled front and rear seats. Driver's and front seat passenger's 3-position seat memory ¹	£1,680.00
Four zone automatic climate control with air filtration, humidity sensing and four zone temperature control for driver, front passenger and independent control for left and right rear passengers (standard on Long Wheelbase)	£510.00
Air quality sensing with auto recirculation	£50.00
Garage door opener with overhead remote control	£305.00
Privacy glass (standard on Long Wheelbase)	£255.00
Front ashtray and lighter	NCO
Electric rear window sunblind (standard on Long Wheelbase)	£305.00
3-spoke wood and soft grain leather heated steering wheel with Jaguar Sequential Shift™ paddles and remote controls for audio system, cruise control, Bluetooth® telephone connectivity and Interactive Voice ²	£595.00
LED rear reading lights	£200.00
Trunk runners	£200.00

NCO No Cost Option

¹Linked to four zone automatic climate control





²Wood and leather steering wheel is only available with gloss wood veneers





Please consult your local Jaguar dealer for details.

PACKS	Retail Price
Illumination Pack - Phosphor blue illumination in front and rear air vents, illuminated tread plates and boot latch finisher	£1,000.00
Sport Exterior Pack - Front aero splitter, rear decklid spoiler, Gloss Black radiator grille with chrome surround, Gloss Black lower mesh, Gloss Black mesh in side power vent, Red painted brake calipers with Jaguar script and 20" Venom alloy wheels in sparkle finish	£2,375.00
Sport Interior Pack - Features upgraded seats and interior trim (as detailed on the Colour and Trim pages) and four zone automatic climate control. Not available with Jaguar Sound System	£3,400.00

PREMIUM LUXURY

ALLOY WHEEL CHOICES

	STANDARD	OPTIONAL	OPTIONAL	OPTIONAL	OPTIONAL
					
	19" TOBA	18" MERU	19" ALEUTIAN	19" TOBA POLISHED	20" KASUGA
FRONT	9.0J x 19"	8.0J x 18"	9.0J x 19"	9.0J x 19"	9.0J x 20"
REAR	10.0J x 19"	9.0J x 18"	10.0J x 19"	10.0J x 19"	10.0J x 20"
OPTION PRICE	–	NCO	£510.00	£1,020.00	£1,020.00

	OPTIONAL	OPTIONAL	OPTIONAL	SPORT PACK
				
	20" KASUGA POLISHED	20" ORONA	20" ORONA POLISHED	20" VENOM ¹
FRONT	9.0J x 20"	9.0J x 20"	9.0J x 20"	9.0J x 20"
REAR	10.0J x 20"	10.0J x 20"	10.0J x 20"	10.0J x 20"
OPTION PRICE	£2,040.00	£1,020.00	£2,040.00	P

NCO No cost option P Option as part of pack
¹Standard when Sport Exterior Pack option is selected
 All 20" alloy wheels require optional 18" space saver spare wheel
 Please consult your local Jaguar dealer for details.

PREMIUM LUXURY

COLOUR AND TRIM CHOICES

EXTERIOR COLOURS			
Standard			
	Ebony		
	Polaris White		
Optional			
Premium	Cashmere		NCO
	Caviar		
	Rhodium Silver		
	Carnelian Red		
	Satellite Grey		
	Stratus Grey		
	Ultimate Black		
	Lunar Grey		
Race Inspired	British Racing Green		£700.00
	Italian Racing Red		
Special	Black Amethyst		£700.00

INTERIOR COLOUR COMBINATIONS			
SEAT	STITCH	UPPER FACIA	HEADLINING
Soft grain leather		Soft grain leather	Morzine
Standard			
Jet	Jet	Jet	Ivory
Cashew	Cashew	Truffle	Ivory
Cirrus	Cirrus	Jet	Ivory
Ivory ¹	Ivory	Oyster	Ivory
Optional			
London Tan ²	Jet/Jet	Jet	Ivory

VENEERS	
Standard	
Gloss Burr Walnut	
Optional	
Piano Black	£1,275.00
Carbon Fibre	£1,275.00
Satin Elm	£205.00
Satin Rosewood	£205.00

SPORT PACK INTERIOR COLOUR COMBINATIONS			
SEAT	STITCH	UPPER FACIA	HEADLINING
Soft grain leather		Soft grain leather	Suedecloth
Jet	Ivory	Jet	Ivory or Jet
Ivory	Jet	Jet	Ivory or Jet

VENEERS	
Piano Black	
Carbon Fibre	

¹Requires heated and cooled front and rear seats plus 3-spoke soft grain leather heated steering wheel

²Requires heated and cooled front and rear seats

Please consult your local Jaguar dealer for details.

PORTFOLIO

KEY FEATURES

Available with Jaguar 3.0 Litre V6 275 Turbocharged Diesel and 3.0 Litre V6 340 Supercharged Petrol engines

Soft grain leather seats with driver's and front seat passenger's electric adjustment (18x18 way)

Driver's and front seat passenger's 3-position seat memory

Heated and cooled front and rear seats

20" Kasuga alloy wheels

Gloss Rich Oak veneer

Meridian Surround Audio System - 825W with single slot CD/DVD

Digital Audio Broadcasting (DAB) radio receiver

Four zone automatic climate control with air filtration, humidity sensing and four zone temperature control for driver, front passenger and independent control for left and right rear passengers

Bi-function HID Xenon headlamps with Adaptive Front Lighting, cornering lamps and intelligent high beam

Reverse park camera with guidance

Suedecloth headlining

3-spoke soft grain leather heated steering wheel with Jaguar Sequential Shift™ paddles and remote controls for audio system, cruise control, Bluetooth® telephone connectivity and Interactive Voice

Heated front screen with timer

OPTIONAL FEATURES

POWERTRAIN AND DRIVING DYNAMICS	Retail Price
Adaptive Cruise Control (ACC) with Forward Alert and Advanced Emergency Brake Assist	£1,275.00
SAFETY AND SECURITY	
Blind Spot Monitor	£460.00
MULTIMEDIA	
Rear Seat Entertainment - 8 inch dual LCD screens (mounted in rear of front headrests) with Rear media Interface and Touch-screen remote control and two sets of WhiteFire® digital wireless headphones	£1,530.00
Television - Digital Tuner	£900.00
Dual View functionality and one set of WhiteFire® digital wireless headphones	£1,900.00
INTERIOR FEATURES	
Electric front seat adjustment (20x20 way) including fore/aft, cushion height, squab recline, cushion tilt, 4-way lumbar, adjustable bolsters, cushion extension and powered headrests. 5 massage functions with 5 intensity settings. Heated and cooled front and rear seats. Driver's and front seat passenger's 3-position seat memory	£380.00
3-spoke wood and soft grain leather heated steering wheel with Jaguar Sequential Shift™ paddles and remote controls for audio system, cruise control, Bluetooth® telephone connectivity and Interactive Voice ¹	£355.00
Air quality sensing with auto recirculation	£50.00

INTERIOR FEATURES (CONTINUED)	Retail Price
Garage door opener with overhead remote control	£305.00
Privacy glass (standard on Long Wheelbase)	£255.00
Front ashtray and lighter	NCO
Electric rear window sunblind (standard on Long Wheelbase)	£305.00
Soft grain leather headlining	£380.00
LED rear reading lights	£200.00
Trunk runners	£200.00
LONG WHEELBASE ADDITIONAL FEATURES	
Delete privacy glass	NCO
Electric rear side window blinds	£500.00
PACKS	
Illumination Pack - Phosphor blue illumination in front and rear air vents, illuminated tread plates and boot latch finisher	£1,000.00
Sport Exterior Pack - Front aero splitter, rear decklid spoiler, Gloss Black radiator grille with chrome surround, Gloss Black lower mesh, Gloss Black mesh in side power vent, Red painted brake calipers with Jaguar script and 20" Venom alloy wheels in sparkle finish	£1,975.00
Sport Interior Pack - Features upgraded seats and interior trim (as detailed on the Colour and Trim pages) and four zone automatic climate control. Not available with Jaguar Sound System	£800.00





NCO No Cost Option





¹Wood and leather steering wheel is only available with gloss wood veneers

Please consult your local Jaguar dealer for details.

PORTFOLIO

ALLOY WHEEL CHOICES

	STANDARD	OPTIONAL	OPTIONAL	OPTIONAL
				
	20" KASUGA	19" ALEUTIAN	19" TOBA	19" TOBA POLISHED
FRONT	9.0J x 20"	9.0J x 19"	9.0J x 19"	9.0J x 19"
REAR	10.0J x 20"	10.0J x 19"	10.0J x 19"	10.0J x 19"
OPTION PRICE	–	NCO	NCO	£1,020.00

	OPTIONAL	OPTIONAL	OPTIONAL	SPORT PACK
				
	20" KASUGA POLISHED	20" ORONA	20" ORONA POLISHED	20" VENOM ¹
FRONT	9.0J x 20"	9.0J x 20"	9.0J x 20"	9.0J x 20"
REAR	10.0J x 20"	10.0J x 20"	10.0J x 20"	10.0J x 20"
OPTION PRICE	£1,020.00	£510.00	£1,530.00	P

NCO No cost option P Option as part of pack

¹Standard when Sport Exterior Pack option is selected

All 20" alloy wheels are supplied with 18" space saver spare wheel as standard

Please consult your local Jaguar dealer for details.

PORTFOLIO

COLOUR AND TRIM CHOICES

EXTERIOR COLOURS			
Standard			
	Ebony		
	Polaris White		
Optional			
Premium	Cashmere		NCO
	Caviar		
	Rhodium Silver		
	Carnelian Red		
	Satellite Grey		
	Stratus Grey		
	Ultimate Black		
	Lunar Grey		
Race Inspired	British Racing Green		£700.00
	Italian Racing Red		
Special	Black Amethyst		£700.00

INTERIOR COLOUR COMBINATIONS			
SEAT Soft grain leather	STITCH/PIPING	UPPER FACIA Soft grain leather	HEADLINING Suedecloth
Jet	Ivory with Ivory	Jet	Ivory or Jet
Navy	Ivory with Ivory	Navy	Ivory
London Tan	Jet with Jet	Jet	Ivory or Jet
London Tan	Navy with Navy	Navy	Ivory
Cashew	Truffle with Truffle	Truffle	Ivory
Cirrus	Mineral with Mineral	Mineral	Ivory
Ivory	Jet with Jet	Jet	Ivory or Jet
Ivory	Truffle with Truffle	Truffle	Ivory
Ivory	Oyster with Oyster	Oyster	Ivory

VENEERS	
Standard	
Gloss Figured Ebony	
Optional	
Piano Black	£1,275.00
Satin Rosewood	£205.00
Satin mid Zebrano	NCO
Carbon Fibre	NCO
Gloss Rich Oak	NCO
Gloss Burr Walnut	NCO
Satin Elm	NCO

SPORT PACK INTERIOR COLOUR COMBINATIONS			
SEAT Soft grain leather	STITCH	UPPER FACIA Soft grain leather	HEADLINING Suedecloth
Jet	Ivory	Jet	Ivory or Jet
Ivory	Jet	Jet	Ivory or Jet

VENEERS	
Piano Black	
Carbon Fibre	

NCO No cost option
Please consult your local Jaguar dealer for details.

SUPERSPORT

KEY FEATURES

Available with Jaguar 5.0 Litre V8 510 Supercharged Petrol engine
 Semi-aniline leather seats with driver's and front seat passenger's electric adjustment (20x20 way)
 5 massage functions with 5 intensity settings
 Driver's and front seat passenger's 3-position seat memory
 Heated and cooled front and rear seats
 20" Mataiva alloy wheels
 Gloss Rich Oak with Linear Laser Inlay
 Meridian Surround Audio System - 825W with single slot CD/DVD
 Digital Audio Broadcasting (DAB) radio receiver
 Television - Digital Tuner
 Rear Seat Entertainment - 8 inch dual LCD screens (mounted in rear of front headrests) with Rear media Interface and Touch-screen remote control and two sets of WhiteFire® digital wireless headphones

Dual View functionality and one set of WhiteFire® digital wireless headphones
 Four zone automatic climate control with air filtration, humidity sensing and four zone temperature control for driver, front passenger and independent control for left and right rear passengers
 Bi-function HID Xenon headlamps with Adaptive Front Lighting, cornering lamps and intelligent high beam
 Reverse park camera with guidance
 Soft grain leather headlining
 3-spoke soft grain leather heated steering wheel with Jaguar Sequential Shift™ paddles and remote controls for audio system, cruise control, Bluetooth® telephone connectivity and Interactive Voice
 Privacy glass
 Electric rear window sunblind
 Heated front screen with timer

OPTIONAL FEATURES

POWERTRAIN AND DRIVING DYNAMICS	Retail Price
Adaptive Cruise Control (ACC) with Forward Alert and Advanced Emergency Brake Assist	£1,275.00
SAFETY AND SECURITY	
Blind Spot Monitor	£460.00
INTERIOR FEATURES	
3-spoke wood and soft grain leather heated steering wheel with Jaguar Sequential Shift™ paddles and remote controls for audio system, cruise control, Bluetooth® telephone connectivity and Interactive Voice ¹	£355.00
Air quality sensing with auto recirculation	£50.00
Garage door opener with overhead remote control	£305.00
Delete privacy glass	NCO
Front ashtray and lighter	NCO
Electric rear side window blinds	£500.00
LED rear reading lights	£200.00
Trunk runners	£200.00

PACKS	
Sport Exterior Pack - Front aero splitter, rear decklid spoiler, Gloss Black radiator grille with chrome surround, Gloss Black lower mesh, Gloss Black mesh in side power vent, Red painted brake calipers with Jaguar script and a choice of 20" Venom alloy wheels in sparkle finish or 20" Mataiva alloy wheels	£1,575.00
Speed Pack - Maximum speed increase from 155mph to 174mph. Also includes revised exterior elements - front aero splitter, rear decklid spoiler, Gloss Black radiator grille with chrome surround, Gloss Black lower mesh, Gloss Black mesh in side power vent, Red painted brake calipers with Jaguar script and a choice of 20" Venom alloy wheels in sparkle finish or 20" Mataiva alloy wheels	£3,630.00

NCO No Cost Option

¹Wood and leather steering wheel is only available with gloss wood veneers
 Please consult your local Jaguar dealer for details.

SUPERSPORT

ALLOY WHEEL CHOICES

	STANDARD	OPTIONAL	OPTIONAL	OPTIONAL	OPTIONAL
					
	20" MATAIVA	19" ALEUTIAN	19" TOBA	19" TOBA POLISHED	20" KASUGA
FRONT	9.0J x 20"	9.0J x 19"	9.0J x 19"	9.0J x 19"	9.0J x 20"
REAR	10.0J x 20"	10.0J x 19"	10.0J x 19"	10.0J x 19"	10.0J x 20"
OPTION PRICE	–	NCO	NCO	£1,020.00	NCO

	OPTIONAL	OPTIONAL	OPTIONAL	SPEED PACK
				
	20" KASUGA POLISHED	20" ORONA	20" ORONA POLISHED	20" VENOM ¹
FRONT	9.0J x 20"	9.0J x 20"	9.0J x 20"	9.0J x 20"
REAR	10.0J x 20"	10.0J x 20"	10.0J x 20"	10.0J x 20"
OPTION PRICE	£1,020.00	NCO	£1,020.00	P

NCO No cost option P Option as part of pack
¹Standard when Speed or Exterior Sport Pack option is selected
 All 20" alloy wheels are supplied with 19" space saver spare wheel as standard
 Please consult your local Jaguar dealer for details.

SUPERSPORT

COLOUR AND TRIM CHOICES

EXTERIOR COLOURS			
Standard			
	Ebony		
	Polaris White		
Optional			
Premium	Cashmere		NCO
	Caviar		
	Rhodium Silver		
	Carnelian Red		
	Satellite Grey		
	Stratus Grey		
	Ultimate Black		
	Lunar Grey		
Race Inspired	British Racing Green		£700.00
	Italian Racing Red		
Special	Black Amethyst		£700.00

INTERIOR COLOURS COMBINATIONS			
SEAT Semi-aniline leather	STITCH/PIPING	UPPER FACIA Soft grain leather	HEADLINING Soft grain leather
Jet	Tonal with Jet	Jet	Ivory or Jet
Bordeaux	Bordeaux	Jet	Ivory or Jet
London Tan	London Tan	Jet	Ivory or Jet
Ivory	Jet with Jet	Jet	Ivory or Jet
Ivory	Navy with Navy	Navy	Ivory
Ivory	Bordeaux with Bordeaux	Bordeaux	Ivory
Ivory	Mineral with Mineral	Mineral	Ivory

ADDITIONAL COLOUR COMBINATIONS IF SPEED PACK IS SELECTED			
SEAT Semi-aniline leather	STITCH/PIPING	UPPER FACIA Soft grain leather	HEADLINING Soft grain leather
Jet	Red Zone with Jet	Jet	Ivory or Jet

VENEERS	
Standard	
Gloss Rich Oak with Linear Laser Inlay	
Optional	
Piano Black	£1,275.00
Carbon Fibre	NCO
Gloss Figured Ebony with Ribbon Laser Inlay	
Gloss Walnut Curl	
Gloss Shadow Walnut	
Satin mid Zebrano	

NCO No cost option

Please consult your local Jaguar dealer for details.

XJR

KEY FEATURES

Available with Jaguar 5.0 litre V8 550 Supercharged Petrol Engine

20" Farallon alloy wheels in Technical Grey finish

Soft grain leather sports seats with 'R' logo and driver's and front seat passenger's electric adjustment (18x18 way)

Driver's and front seat passenger's 3-position seat memory

Heated and cooled front and rear seats

Four zone automatic climate control with air filtration, humidity sensing and four zone temperature control for driver, front passenger and independent control for left and right rear passengers

3-spoke soft grain leather heated steering wheel with 'R' logo

Meridian Surround Audio System - 825W with single slot CD/DVD

Digital Audio Broadcasting (DAB) radio receiver

Television - Digital Tuner

Dual View Functionality with one set of WhiteFire® digital wireless headphones

Unique 'R' Intaglio

Suedecloth headlining

Red Painted brake calipers with Jaguar script

Sports exhaust with quad tailpipes

Front splitter

Rear spoiler

Unique side sills

Heated front screen with timer

OPTIONAL FEATURES

POWERTRAIN AND DRIVING DYNAMICS	Retail Price
Adaptive Cruise Control (ACC) with Forward Alert and Advanced Emergency Brake Assist	£1,275.00
Carbon fibre engine cover	£1,295.00

SAFETY AND SECURITY	
Blind Spot Monitor	£460.00

INTERIOR FEATURES	Retail Price
Soft grain leather headlining ¹	£380.00
Air quality sensing with auto recirculation	£50.00
Garage door opener with overhead remote control	£305.00
Privacy Glass	£255.00
Front ashtray and lighter	NCO
Electric rear window sunblind	£305.00
LED rear reading lights	£200.00
Trunk/Boot runners	£200.00

PACKS	Retail Price
Illumination Pack - Phosphor blue illumination in front and rear air vents, illuminated tread plates and boot latch finisher	£1,000.00

NCO No cost option

¹Available in Jet only

Please consult your local Jaguar dealer for details.

XJR

COLOUR AND TRIM CHOICES

	STANDARD WHEEL	OPTIONAL WHEEL
	20" FARALLON TECHNICAL GREY	20" FARALLON SPARKLE SILVER
FRONT	9.0J x 20"	9.0J x 20"
REAR	10.0J x 20"	10.0J x 20"
OPTION PRICE	–	£510.00

EXTERIOR COLOURS

Standard

Ebony
Polaris White

Optional

Premium	Cashmere	NCO
	Caviar	
	Rhodium Silver	
	Carnelian Red	
	Satellite Grey	
	Stratus Grey	
	Ultimate Black	
	Lunar Grey	
Race Inspired	British Racing Green	£700.00
	Italian Racing Red	
Special	Black Amethyst	£700.00

INTERIOR COLOUR COMBINATIONS

SEAT Soft grain leather	STITCH	UPPER FACIA Soft grain leather	HEADLINING Suedecloth
Jet	Red Zone	Jet	Jet
Jet	London Tan	Jet	Jet
Jet/Red Zone	Red Zone	Jet	Jet
Jet/London Tan	London Tan	Jet	Jet
Jet/Ivory	Ivory	Jet	Jet

VENEERS

Standard

Piano Black

Optional

Carbon Fibre	NCO
--------------	-----

NCO No cost option

Please consult your local Jaguar dealer for details.

ACCESSORIES

EXTERIOR STYLING			Retail Price
Polished tailpipe finishers	Polished stainless steel exhaust finishers add further style and refinement to your XJ		C2D25247 £292.52
Aero splitter and decklid spoiler	Aggressive front aero splitter featuring colour coded outer sections and gloss black centre piece, lowers the front profile of the XJ to guide air beneath the chassis more efficiently at speed, improving overall performance dynamics. A refined colour-keyed decklid spoiler further increases downforce at speed, providing real handling improvements. Please note Splitter and Spoiler must be fitted in unison		C2D26935LML £608.64
Gloss Black radiator and lower intake grilles	Offered in a glinting Gloss Black finish, providing an aggressive finish	Black lower grille	C2D23093 £190.62
		Black radiator grille kit	C2D23092 £242.92
Gloss Black side power vents	Add an aggressive styling upgrade with Gloss Black Side Power Vents		C2D23094/C2D23095 £173.90
Chrome mirror covers	Chrome mirror covers accentuate the stylish design of the XJ's exterior mirrors		C2D5488 & C2D5489 £179.23
Splash guards	Front and rear Jaguar branded splash guards complement the lines of the XJ and provide protection to the vehicle from dirt and stone chippings	Front	C2D8498 £82.40
		Rear	C2D8499 £82.40
Styled valve caps	Complete the look of your XJ's alloy wheels with custom valve caps	Valve caps with Black Jack	C2D19598 £26.40
		Valve caps with Union flag	C2D19599 £26.40
		Valve caps with Jaguar Growler	C2D19596 £26.40
		Valve caps with 'R' Logo	C2D19597 £26.40
Centre wheel badge	A distinctive red centre wheel badge featuring the Jaguar logo that fits all available alloy wheels	Red wheel centre badge	C2D12326 £14.40
Alloy Wheels	The alloy wheels shown throughout the XJ Specification and Price Guide may also be available as an accessory fitment. Please consult your local Jaguar dealer for availability	Aleutian 19"	Front/Rear C2D4499/C2D4500 £1060.46/£1125.40
		Amirante 20"	Front/Rear C2D7439/C2D7440 £1205.08/£1293.68
		Kasuga 20"	Front/Rear C2D4245/C2D4246 £1168.68/£1255.24
		Kasuga polished 20"	Front/Rear C2D9177/C2D9178 £1293.68/£1359.60
		Meru 18"	Front/Rear C2D4497/C2D4498 £869.32/£980.56
		Orona 20"	Front/Rear C2D7283/C2D7284 £1205.08/£1293.68
		Orona polished 20"	Front/Rear C2D7285/C2D7286 £1293.68/£1359.60
		Toba 19"	Front/Rear C2D7287/C2D7288 £1071.20/£1137.12
Growler wheel nuts	Enhance the look of your alloy wheels with Jaguar Growler branded black or chrome wheel nuts	Wheel nut kit - Growler chrome	C2D20072 £177.00
		Wheel nut kit - Growler black	C2D20073 £177.00

Please consult your local Jaguar dealer for details.

ACCESSORIES

INTERIOR STYLING			Retail Price	
Illuminated sill tread plates	Elegantly styled aluminium sill tread plates illuminate when the driver or passenger doors are opened. Highlighted by soft phosphor blue lighting	Standard Wheelbase front left/right	C2D22753/C2D22752	£235.63
		Standard Wheelbase rear left/right	C2D22754/C2D22756	£228.67
		Long Wheelbase front left/right	C2D22753/C2D22752	£235.03
		Long Wheelbase rear left/right	C2D22755/C2D22757	£235.63
Sport pedal covers	Made from stainless steel and rubber, the pedal kit fits securely over existing pedals for a contemporary, sporting appearance	RHD/LHD	C2D8416	£127.31
Gear selector	A specially designed gear selector with premium dark leather finished top and rubber bezel with soft touch grip		C2D21919PVJ & C2D21956	£84.46
Intaglio	To add a further degree of individuality, the Jaguar branded Intaglio at the front of the XJ's cabin can be personalised with your own name, inscription, design or logo. It is also offered with a variety of other designs, including XJ creator Ian Callum's signature	Jaguar Flag	C2D14681	£52.54
		Ian Callum signature	C2D17977	£169.94
		Personalised	C2D14682	£454.85
Illuminated boot finisher	Outlining the luggage compartment with laser thin phosphor blue lines of light, this stylish Jaguar branded stainless steel finisher fills the area with a cool distinctive glow		C2D22758	£324.90
Luggage compartment premium carpet mat	Luxurious soft luggage mat in Jet Black with the Jaguar logo. Deep premium 2000 g/m ² pile with nubuck edging and Dove contrast stitch		C2D7450	£125.66

ACCESSORIES

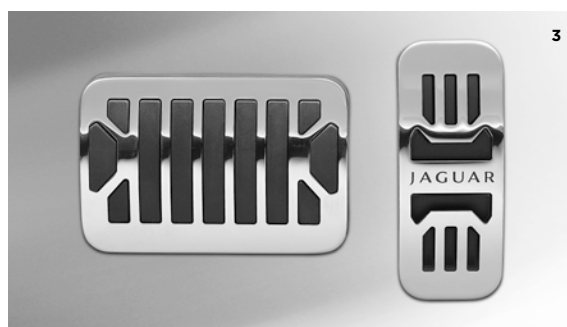

1. GEAR SELECTOR 2. ILLUMINATED SILL TREAD PLATES 3. SPORT PEDAL COVERS 4. AERO SPLITTER 5. DECKLID SPOILER

Please consult your local Jaguar dealer for details.

ACCESSORIES

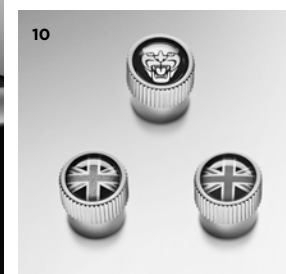

6. SPLASH GUARDS 7. CHROME MIRROR COVERS 8. POLISHED STAINLESS STEEL EXHAUST FINISHERS 9. INTAGLIO 10. STYLED VALVE CAPS 11. GROWLER WHEEL NUTS

ACCESSORIES

INTERIOR UTILITY			Retail Price	
Headrest mounted coat hanger	Mounting simply and securely this coat hanger is easy to fit and remove and provides a convenient stowage point to keep clothing wrinkle free	C2Z23416	£35.59	
Premium infant carrier	Designed for the optimal safety of babies and small children (birth - 13kg) to ride securely in the XJ. Recommend with ISOFIX base	C2C21866	£248.40	
Child seat	Built to the highest safety standards to ensure children (9kg - 18kg) experience the full security of the XJ's seatbelts. Recommend with ISOFIX base	C2C35104	£371.00	
Child seat with booster cushion	Helps raise slightly older children (15kg - 36kg) so that they can receive the full benefit of the XJ's seatbelt system. Recommend with ISOFIX base	C2C35572	£213.00	
ISOFIX base	Base for Childseat Group O+	C2C32923	£243.49	
Rubber footwell mats	Hard wearing Jaguar branded rubber mats provide added protection for your XJ's carpets	Standard Wheelbase front	C2D7784	£84.40
		Standard Wheelbase rear	C2D27141	£59.74
		Long Wheelbase front	C2D7784	£82.40
		Long Wheelbase rear	C2D27142	£89.62
Ski bag	Manufactured from durable 600D polyester the ski bag features padded construction to provide protection and shoulder straps to aid carrying. Carries up to two pairs of skis and poles up to 180cm long	C2Z23531	£127.30	
Luggage compartment liner	This premium liner tailored specifically for the XJ luggage compartment will protect the load space area of the boot. Light and durable, it is easily removable for cleaning	C2Z5613	£111.24	
Luggage compartment nets	A set of two nets provide additional enclosed storage in the luggage compartment and help to secure loose items such as bags or small parcels	C2D14680	£45.32	
Ski hatch	Convenient hatch providing the ability to carry skis, snowboards or other long items through the loadspace into the cabin area	Standard seat	C2D23137	£648.90
		Electric seat	C2D24404	£763.85
Battery charger	Diagnoses, monitors and maintains the battery at optimum levels ensuring prolonged battery life and reliability. Features integrated wiring and a dedicated DIN socket within the loadspace area, providing convenience and ease of use	C2P24103	£118.40	
iPad holder	Mounts to front seat headrests providing a flexible solution for rear seat entertainment. Quick release design ensures iPad can be fitted or removed quickly and easily	C2Z22935	£160.68	
Flexible luggage retainer	Provides a neat stowage solution to help secure luggage or other items within the loadspace area	C2D20903	£43.28	
Premium seat back stowage	Bespoke seat back stowage offered in a premium high quality leather material provides a neat stowing solution in the cabin area for small/handheld items. Features embossed Jaguar branding and high quality synthetic materials for interior compartments	C2Z24589	£175.02	

ACCESSORIES

CAR CARE, TRACTION AIDS AND MAINTENANCE			Retail Price	
Alloy wheel cleaner	Jaguar and Autoglym have collaborated to develop and rigorously test a unique high performance wheel cleaner formula. This specially formulated alloy wheel cleaner is the only wheel cleaning product approved as compliant with Jaguar's exacting technical requirements and is officially recommended for all Jaguar vehicles. Available as a 500ml trigger spray	C2D20074	£12.00	
All-weather car cover	All-weather tailored cover for the XJ with the Jaguar logo. Protect your XJ from the elements, including showers, frost and dust. Quick and easy to fit	Standard Wheelbase	C2D7599	£330.62
		Long Wheelbase	C2D8821	£353.28
		Snowsock Pack 695	C2D20229	£86.00
Snow sock winter traction aid	An innovative lightweight textile alternative to snowchains for traction in snowy and icy conditions. Please consult your local Jaguar dealer for the correct pack to suit your wheel and tyre size	Snowsock Pack 697	C2D20230	£86.00
		Snowsock Pack 69J	C2D20228	£86.00
		Snow traction system	High grip snow chain traction system for driving in snowy, muddy or icy conditions. Fits the rear wheels only	XR836517
Fire extinguisher	Dry-powder 1kg extinguisher for a range of fires, including petrol and electrical. Kit includes a bracket for mounting on the floor or the driver's seat	C2D14752	£94.00	
First aid kit	A comprehensive kit for minor injuries	C2A1287	£48.00	
Warning triangle	Two-tone reflective triangle for use after a breakdown or accident, day or night	C2520992	£41.20	
Locking wheel nuts	Protect your wheels with custom designed high security locking wheel nuts	C2C9198	£87.00	
Stolen vehicle tracking	Jaguar TrackStar is an authorised pan-European vehicle tracking system. Fully compliant with insurance standards, your XJ can be constantly monitored and located in any country with GSM mobile phone systems	Please consult your local Jaguar dealer.		

Please consult your local Jaguar dealer for details.

ACCESSORIES

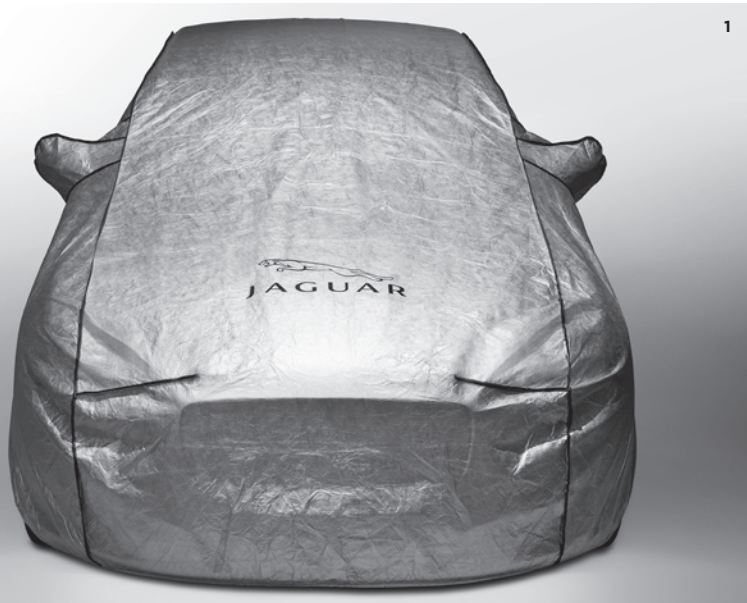

1. ALL-WEATHER CAR COVER 2. SNOW SOCK WINTER TRACTION AID 3. CHILD SEAT 4. RUBBER FOOTWELL MATS

ACCESSORIES

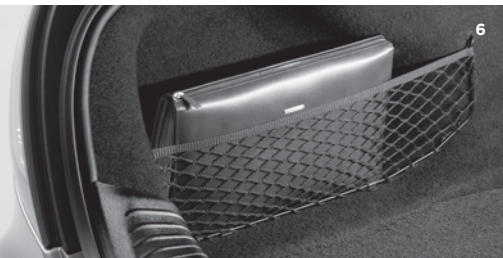

5. LUGGAGE COMPARTMENT PREMIUM CARPET MAT 6. LUGGAGE COMPARTMENT NET 7. FLEXIBLE LUGGAGE RETAINER 8. HEADREST MOUNTED COAT HANGER 9. IPAD HOLDER

GLOSSARY

POWERTRAIN AND DRIVING DYNAMICS

JAGUAR SEQUENTIAL SHIFT™

Provides the choice of Drive, Sport Automatic or Manual gearshift modes, with one touch paddles mounted behind the steering wheel to control gear changes up and down manually.

JAGUARDRIVE CONTROL™

Offers different modes selectable by a button to optimise the vehicle response depending on driving conditions and style.

DYNAMIC STABILITY CONTROL (DSC)

Intervenes in demanding driving situations by applying braking to individual wheels and reducing engine torque.

TRAC DSC MODE

Trac DSC optimises the DSC settings for maximum traction in difficult conditions such as packed snow. The less restrictive settings of Trac DSC also enable a more involving and focused driving experience.

DYNAMIC MODE

Dynamic mode co-ordinates the car's control systems to deliver a high performance driving experience. When Dynamic mode is selected, the transmission switches to manual and Trac DSC is automatically engaged.

WINTER MODE

Designed for use in slippery conditions, Winter mode selects 2nd gear for pulling away on level ground. This helps to ensure that optimum traction is maintained.

ADAPTIVE DYNAMICS

Continuously monitors the road and driver inputs and optimises the car's suspension settings for ride comfort and control.

ACTIVE DIFFERENTIAL

Limits the slip between the rear wheels, improving traction on uneven road surfaces. Can also improve stability in oversteer situations.

CRUISE CONTROL WITH AUTOMATIC SPEED LIMITER (ASL)

In tandem with cruise control, an Automatic Speed Limiter (ASL) allows the driver to select a maximum speed above 18mph (30km/h) that should not be exceeded.

ADAPTIVE CRUISE CONTROL (ACC)

Uses microwave radar technology to monitor for slower moving traffic and can alert you to potential hazards ahead. It also controls both throttle and brakes to help maintain a constant time gap to the vehicle in front. When the road ahead clears, the system automatically accelerates back to the speed at which you were driving. Forward Alert provides an audible warning if traffic ahead slows.

ADVANCED EMERGENCY BRAKE ASSIST

Is an enhancement to the ACC function. The system calculates distance and speed of approach to the vehicle in front and pre-charges the brakes to minimise impact speed if a collision is predicted. The ACC interacts with the Virtual Instruments to provide the driver with information on driving conditions.

INTELLIGENT STOP/START

Stop/Start is a technology that stops the engine when it is not needed, improving the fuel economy and reducing the car's CO₂ emissions. The engine will re-start immediately as soon as the driver's foot is released from the brake pedal.

PERFORMANCE EXHAUST WITH QUAD TAILPIPES

A unique performance tuning gives a distinctive aural signature.

SAFETY

AIRBAG AND SEAT OCCUPANT SENSING SYSTEM

Side airbags, curtain airbags and two-stage driver and front passenger airbags, all controlled by a seat occupant sensing system to ensure they work only when needed. The Anti-Whiplash System, built into the XJ's front seats and 'soft-landing' technology in the seat-belt retractors soften contact with the airbags in the front.

PEDESTRIAN CONTACT SENSING SYSTEM™

Industry-leading system that senses an impact between a pedestrian and the front of the car. It instantaneously raises the bonnet through a small distance in a very controlled way, to help prevent the pedestrian from contacting hard points under the bonnet.

EXTERIOR FEATURES

POWER BOOT LID WITH HEIGHT ADJUSTMENT

The boot lid is opened and closed electronically, with either a single press on the remote key, a switch inside the boot lid or by the external bumper switch. The boot lid is easily programmed to open to your required height.

ADAPTIVE FRONT LIGHTING

Sensors react to the car's speed and steering input, and the system can deflect headlamp beams casting light deeper into corners, giving added confidence at night. Intelligent high beam automatically maximises driver visibility. When sensing preceding, oncoming traffic or street lights, the headlamps will automatically switch to low beam.

BLIND SPOT MONITOR

Uses radar sensors to remotely cover areas that cannot be seen either directly or by the mirror, and alerts the driver of overtaking traffic with an amber warning icon in the external mirrors.

REAR PARKING AID

Rear parking aid with Touch-screen visual indicator.

FRONT PARKING AID

Front parking aid with Touch-screen visual indicator.

REVERSE PARK CAMERA WITH GUIDANCE

Combines a rear-facing camera with the Touch-screen information, it features coloured distance guides and on-screen guidance lines that move according to steering wheel angle to indicate the area into which the car will reverse.

INTERIOR FEATURES

JAGUAR SENSE™

An electronic control system that operates the front overhead console lights and opening of the glovebox by a light touch.

JAGUAR SMART KEY SYSTEM™

With the Jaguar Smart Key in your pocket or bag, the car automatically unlocks as you pull the door handle. Simply push the ignition button to start the engine. Upon leaving, press a button on the door handle to lock the car or use the Jaguar Smart Key.

DUAL ZONE CLIMATE CONTROL

With humidity control, air filtration and dual temperature control for driver and front passenger.

FOUR ZONE CLIMATE CONTROL

Adds independent automatic temperature control for left and right rear passengers in addition to the front dual zone.

MESSAGE - FRONT SEATS

5 massage functions - wave, up, down, lumbar and shoulder with 5 levels of intensity.

MESSAGE - REAR SEATS

3 massage functions - wave, lumbar and shoulder.

LONG WHEELBASE

Long Wheelbase models feature additional space in the rear cabin with 1,121mm of rear legroom, 134mm more than the Standard Wheelbase. Additional features as standard include four zone automatic climate with independent temperature controls for rear seat passengers, illuminated rear vanity mirrors, and rear privacy glass. Optional features include rear window electric sunblind and rear passenger window manual sunblinds.

GLOSSARY [CONTINUED]

MULTIMEDIA

VIRTUAL INSTRUMENTS¹

12.3 inch screen with TFT (Thin Film Transistor) technology that replaces a traditional instrument cluster. Virtual information display to include speed, rpm, distance, trip computer functionality and key information for navigation, audio and telephone. Includes normal, Winter and Dynamic Mode displays.

TOUCH-SCREEN¹

8 inch colour Touch-screen display that controls major functions including audio, climate control, Bluetooth[®] telephone connectivity, trip computer and navigation.

DUAL VIEW TOUCH-SCREEN^{1,2}

Allows driver and passenger to see two different views on the same 8 inch colour Touch-screen, enabling access to different functions at the same time. Driver enabled access to Touch-screen controls, audio and navigation. Passenger has WhiteFire[®] digital wireless headphones to watch TV or DVD via Dual View controls.

INTERACTIVE CONTROLS

Two 5-way steering wheel mounted controls allow the driver to manage frequently-used functions via Virtual Instrument menus without taking hands off the wheel or looking at Touch-screen menus. Additional controls below the steering wheel spokes operate Cruise Control, telephone and Interactive Voice functions.

INTERACTIVE VOICE^{1,3}

Gives the user voice control of audio, Bluetooth[®] telephone connectivity and navigation functions. When in operation, as well as audible prompts, all commands appear in the Virtual Instruments.

MEDIA HUB

The Media Hub allows various devices to be connected to the car, whether this is wirelessly via Bluetooth[®] or through the Front Media Interface for audio and video. Located in the centre console storage box, a docking panel includes a 3.5mm auxiliary jack plug socket, a 12-volt power supply, plus two USB connectors that allow connectivity with a wide range of USB devices. The dock is compatible with all iPod's from generation 3 to the latest iPod touch. It will also support any USB mass-storage device and MP3 players with USB connectivity. Full function control of iPod or MP3 is available through the Touch-screen menus.

FRONT MEDIA INTERFACE

Part of the Media Hub. Allows the connection of an iPod, MP3 player or two USB Mass Storage Devices to the in-car sound system, each independently controlled via the 8 inch Touch-screen and steering wheel mounted controls.

REAR MEDIA INTERFACE

Part of the Media Hub. Allows the connection of an iPod, MP3 player or one USB Mass Storage Device in the rear when Rear Entertainment is fitted.

SINGLE SLOT CD/DVD²

Single slot CD/DVD which is capable of playing video and audio discs. File formats include Windows Media Audio (WMA), AAC and MP3.

BLUETOOTH[®] AUDIO STREAMING

A Bluetooth[®] equipped Jaguar, enables hands free use of your mobile phone at any time when the phone is in the car through the Touch-screen. Bluetooth[®] also provides the ability to stream audio content, and full function control enables easy track selection. Bluetooth[®] is compatible with many mobile phones from most manufacturers including Apple, BlackBerry[®] and HTC - ask your local Jaguar dealer or visit jaguar.co.uk for more details.

MULTIMEDIA [CONTINUED]

JAGUAR AUDIO SYSTEM (250W)²

250W with AM/FM radio featuring single slot CD/DVD, MP3 compatibility, a hard disk drive (HDD) for storage of up to 10 CDs of uncompressed music and 12 speakers. Controlled through the Touch-screen and Interactive Controls. Powered by a dedicated 8-channel amplifier featuring Audyssey MultEQ[®] audio equalisation and Dynamic Volume Control, that actively compensates for cabin noise. This amplifier powers 12 speakers, with 3 in each door.

MERIDIAN AUDIO SYSTEM (380W)²

As Jaguar Audio System, with a powerful 12-channel Class-D, DSP amplifier featuring Audyssey MultEQ[®] audio equalisation, a hard disk drive (HDD) for storage of up to 10 CDs of uncompressed music and Dynamic Volume Control with 14 speakers, including 2 subwoofers and 2.8 inch front door woofers. In addition to the cabin audio output this system features 3 additional audio channels which can be accessed through the WhiteFire[®] digital wireless headphones when either Dual View or Rear Seat Entertainment is specified.

MERIDIAN SURROUND AUDIO SYSTEM (825W)²

As Jaguar Audio System, with either Dolby[®] Pro Logic[®] IIX or DTS[™] neo 6, a hard disk drive (HDD) for storage of up to 10 CDs of uncompressed music and 20 speakers including 2 subwoofers and 2 front door woofers. In addition to the cabin audio output this system features 3 additional audio channels which can be accessed through the WhiteFire[®] digital wireless headphones when either Dual View or Rear Seat Entertainment is specified. The headphone system includes Dolby[®] Headphone Surround when listening to the DVD source.

NAVIGATION SYSTEM WITH HDD MAPPING¹

HDD based system, providing faster access to data including postcode entry, destination entry on the move (Europe only), voice guidance, voice control input, RDS and TMC (Traffic Messaging Channel)/Dynamic Route guidance, accessed through Touch-screen control system. The navigation system can be set to interact with the Virtual Instruments. On approach to a junction or turning, navigation information will be displayed in the information dial in the Virtual Instruments.

TRAFFIC MESSAGE CHANNEL (TMC)¹

An application of the FM Radio Data System (RDS) used for broadcasting real-time traffic and weather information. Data messages are received and decoded by a TMC-equipped car radio or navigation system, and delivered to the driver in a variety of ways. The most common of these is a TMC-enabled navigation system that can offer dynamic route guidance, alerting the driver of a problem on the planned route and calculating an alternative route to avoid the incident.

REAR SEAT ENTERTAINMENT

State of the art digital Rear Entertainment system with either 8 inch or 10.2 inch dual screens with remote control function. The system also includes a Rear Media Interface, that allows connectivity with a wide range of USB devices. With Rear Seat Entertainment fitted, rear passengers can watch TV, DVD or streamed video via the Rear Media Interface. The system includes dual WhiteFire[®] digital wireless headphones and transmitter.

¹The navigation system must always be used in conditions that will not affect the driver's ability to drive safely or affect the safety of other road users

²Different DVDs exist in different regions. Please consult your local Jaguar dealer for details of which countries are covered by the DVD supplied with your vehicle

³Interactive Voice - please consult your local Jaguar dealer for language availability

Please consult your local Jaguar dealer for details.

OWNERSHIP EXPERIENCE

Service, assurance, and peace of mind are all part of the pride of owning your XJ.

THE JAGUAR ACCESSORY RANGE†

Enabling you to personalise your car, to create a driving experience that is even more individually rewarding. All Jaguar accessories are tested rigorously for safety and durability in the most arduous of climates and conditions. A comprehensive range of styling options, interior and exterior accessories, enabling you to tailor your XJ to suit your personal style. The full range of Jaguar accessories is available to view on-line, please visit jaguar.co.uk for further information.

Any genuine Jaguar Accessories (excluding gift items and luggage from Jaguar Collection) supplied and fitted by a Jaguar dealer within one month or 1,000 miles/1,500km (whichever occurs first) of a new vehicle being put into service will benefit from the same warranty terms and duration as the Vehicle Warranty. Accessories purchased outside of this period will be subject to 12 month unlimited mileage warranty.

BECAUSE ONLY THE BEST WILL DO

An official Jaguar dealer or Approved Service Centre can ensure that Jaguar trained, specialist technicians, with access to the full range of Jaguar approved parts and tools, will always be on hand to guarantee that every fitting, or repair, is carried out exactly the way Jaguar intended. Your Jaguar dealer or Approved Service Centre can also supply and fit Jaguar approved accessories to personalise and add to the practicality and style of your XJ model.

SERVICE AND ASSURANCE*

Complete peace of mind including Competitively Priced Servicing, Seasonal Health Checks and Total Tyre Care to ensure that your Jaguar XJ retains its premium condition, delivering optimal performance.

WARRANTY*

3 year warranty together with a 3 year Paint Surface Warranty and a 6 year Corrosion (Perforation) Warranty.

JAGUAR MAGAZINE

Jaguar Magazine is the official magazine of Jaguar Cars. It features the Jaguar F-TYPE, XJ, XK and XF, and the worlds of luxury, style, design and travel. The fully interactive Jaguar Magazine iPad app takes the very best of the print edition of the Magazine and adds extra images, and exclusive information, allowing you to explore Jaguar's world in a whole new way.

JAGUAR.CO.UK

Jaguar's official interactive website contains the latest information on Jaguar models and pricing. It also features helpful tools such as a dealer locator and a new model configurator allowing you to see the car tailored to your specification and colour.

JAGUAR FINANCIAL SERVICES*

Whether your requirements are business or personal please contact your local Jaguar dealer to discuss a range of finance and insurance products that can be tailored to meet your needs.

†All Jaguar Approved Accessories are rigorously tested to the same exacting standards as those applied to our vehicles. Performance in extreme hot and cold temperatures, corrosion resistance, impact and airbag deployment highlight some of the exhaustive product testing carried out so that Accessories are both durable and importantly, continue to comply with current legalisation

*Terms and conditions apply. Please contact your local Jaguar dealer for more information



IMPORTANT NOTICE

Jaguar Land Rover Limited is constantly seeking ways to improve the specification, design and production of its vehicles and alterations take place continually. Whilst every effort is made to produce up-to-date literature, this brochure should not be regarded as an infallible guide to current specifications, nor does it constitute an offer for the sale of any particular vehicle. Distributors and dealers are not agents of Jaguar Land Rover Limited by any express or implied undertaking or representation.

Comparisons are based on manufacturer's own data and testing.

ENVIRONMENTAL INNOVATION AT JAGUAR

Jaguar is proud to continue the company's tradition with its approach to Environmental Innovation. From the choice of lightweight materials and lean production methods to the efficiency of its engines and designs, Jaguar is committed to operating as a more sustainable business and reducing its overall environmental impact.

Jaguar's flagship XJ model was the first in the company to achieve ISO 14040, the international standard for vehicle 'whole life cycle' assessment. This certification measures the environmental impact of XJ from component material sourcing and manufacturing process, through its driven life time, to final disposal. But that's not all. Every new Jaguar vehicle is designed to be 85% recyclable and reusable, in addition to 95% recoverable and reusable with 10% for energy generation.

The XJ, F-TYPE and XK's innovative use of lightweight aluminium, which incorporates up to 50% recycled material from the manufacturing process of the body structures, provides considerable performance benefits. This includes improved fuel consumption and less CO₂ emissions associated with lighter structures as well as the dynamic performance inherent in its weight saving design.

Jaguar is committed to reducing dependency on fossil fuels, using fewer resources and creating less waste. Already the manufacturing assembly CO₂ emissions of each Jaguar built in the UK since 2009 is offset. For every tonne of CO₂ emitted in the assembly process, Jaguar invests in carbon reduction projects that reduce an equivalent tonne of CO₂ elsewhere. To date Jaguar Land Rover has offset over 6 million tonnes of CO₂ and improved the health of over 1 million people from our carbon reduction projects around the world.

Offsetting allows Jaguar to take action now, to reduce its impact on the environment, as part of an integrated carbon management plan. This company plan includes targets to reduce operating CO₂ emissions and waste to landfill by 25% by our fiscal year end 2012-13, water consumption by 10% by our fiscal year end 2012-13 and fleet average tailpipe CO₂ emissions by 25% by 2015, based on 2007 levels.

But it doesn't stop there. World class manufacturing facilities certified to ISO 14001 since 1998, CO₂ emissions from transport miles on all our delivery routes, for all our products, have been cut by 22% since 2008 and we have one of the largest roof installations in the UK, of PV cells at our headquarters in Whitley, Coventry.

The Bluetooth® word mark and logos are owned by the Bluetooth SIG, Inc. and any use of such marks by Jaguar Land Rover Limited is under license.

iPod, iPod touch and iPad are trademarks of Apple Inc., registered in the U.S. and other countries.

BlackBerry® is a trademark of Research In Motion Limited and is registered in the U.S. and may be pending or registered in other countries.

Dolby and Pro Logic are registered trademarks of Dolby Laboratories.

Meridian Audio is a registered trademark of Meridian Audio LTD.

Jaguar Land Rover Limited,
Registered Office: Abbey Road, Whitley,
Coventry, CV3 4LF, United Kingdom
Registered in England Number: 1672070
jaguar.co.uk

XJ_14MY_June 2013

