

DEFENDER



ABOVE AND BEYOND



SPECIFICATION

Defender offers an exclusive range of options that allow you to personalise your vehicle. The following pages take you through a logical series of steps to create your ideal Defender. You have several choices: from selecting your bodystyle to exterior and interior colours before choosing your wheels, finishes and additional options.



The Defender engine



Step 1

Choose your bodystyle

A wide variety of bodystyles and wheelbases provide optimum capability to get the most from your Defender.



Step 2

Choose your colour

There's an extensive range of paints that provide durable coatings designed for the toughest working environments.

Visit landrover.co.uk for more information.

Build & Price

**Print
Save
Exit**



Step 3
Choose your wheels

Defender's iconic looks can be complemented with a range of wheel options.



Step 4
Choose your interior

A selection of stylish, durable trim combinations are available for practicality, comfort and even a touch of luxury.



Step 5
Choose your options

Additional options can enhance and ensure optimum capability of your Defender.



Technical Details

Technical information and data for dimensions, performance and specifications.



Accessories

A range of durable and practical accessories. You can tailor your vehicle to your specific needs.

[Build & Price](#)

[Print](#)
[Save](#)
[Exit](#)

ENGINE – THE DEFENDER ENGINE

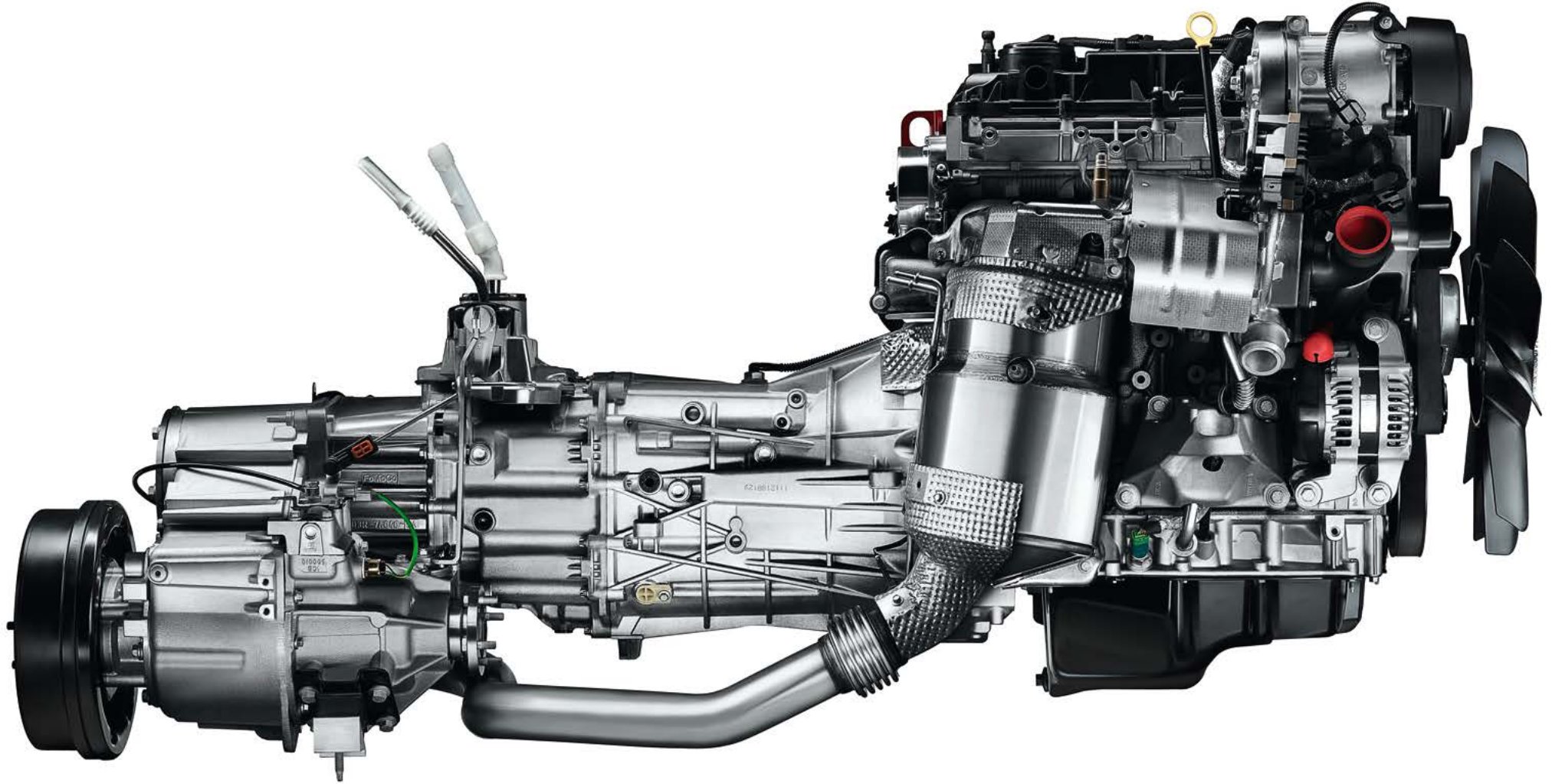

[Build & Price](#)

[Print](#)
[Save](#)
[Exit](#)

DEFENDER MODELS

	LIST PRICE	VAT 20.0%	RETAIL PRICE	ON THE ROAD PRICE
90				
Hard Top	£19,016.67	£3,803.33	£22,820.00	£23,095.00
Hard Top XS	£22,908.33	£4,581.67	£27,490.00	£27,765.00
Pick Up	£19,016.67	£3,803.33	£22,820.00	£23,095.00
Station Wagon	£20,820.83	£4,164.17	£24,985.00	£25,260.00
County Station Wagon	£22,520.83	£4,504.17	£27,025.00	£27,300.00
XS Station Wagon	£24,854.17	£4,970.83	£29,825.00	£30,100.00
110				
Chassis Cab	£20,033.33	£4,006.67	£24,040.00	£24,315.00
Hard Top	£20,608.33	£4,121.67	£24,730.00	£25,005.00
Pick Up	£19,904.17	£3,980.83	£23,885.00	£24,160.00
High Capacity Pick Up	£20,487.50	£4,097.50	£24,585.00	£24,860.00
Station Wagon	£22,783.33	£4,556.67	£27,340.00	£27,615.00
County Station Wagon	£24,391.67	£4,878.33	£29,270.00	£29,545.00
XS Station Wagon	£27,270.83	£5,454.17	£32,725.00	£33,000.00
Utility Wagon	£22,783.33	£4,556.67	£27,340.00	£27,615.00
County Utility Wagon	£24,391.67	£4,878.33	£29,270.00	£29,545.00
XS Utility Wagon	£26,437.50	£5,287.50	£31,725.00	£32,000.00
Double Cab	£21,366.67	£4,273.33	£25,640.00	£25,915.00
County Double Cab	£22,904.17	£4,580.83	£27,485.00	£27,760.00
XS Double Cab	£24,854.17	£4,970.83	£29,825.00	£30,100.00
130				
Chassis Cab	£21,200.00	£4,240.00	£25,440.00	£25,715.00
Double Cab Chassis Cab	£22,987.50	£4,597.50	£27,585.00	£27,860.00
Double Cab	£24,737.50	£4,947.50	£29,685.00	£29,960.00

Visit landrover.co.uk for more information.

Build & Price

**Print
Save
Exit**

STEP 1 CHOOSE YOUR BODYSTYLE



[Build & Price](#)

[Print](#)
[Save](#)
[Exit](#)



DEFENDER 110 CHASSIS CAB



DEFENDER 110 DOUBLE CAB PICK UP



DEFENDER 130 DOUBLE CAB HIGH CAPACITY PICK UP



DEFENDER 90 STATION WAGON



DEFENDER 110 STATION WAGON



DEFENDER 110 UTILITY WAGON



DEFENDER 130 DOUBLE CAB CHASSIS



DEFENDER 90 HARD TOP



DEFENDER 110 HARD TOP



DEFENDER 110 HIGH CAPACITY PICK UP



DEFENDER 130 CHASSIS CAB



DEFENDER 90 PICK UP



DEFENDER 110 PICK UP

STEP 1 CHOOSE YOUR BODYSTYLE

Defender is available in a wide variety of body styles and three wheelbases. All of which give optimum capability to a range of potential uses. Choosing the appropriate body type for your requirements will help you get the most from your Defender.



DESIRABLE CHARACTERISTICS

TOWING - short distance (e.g. agriculture)
Manoeuvrability, good rear visibility



TOWING - long distance (e.g. exhibition units)
Directional stability, fuel range



CARRYING EQUIPMENT (heavy, valuable, vulnerable)
Loadspace, payload, security, protection from the elements



CARRYING MATERIALS (loose, dirty, smelly, livestock)
Loadspace, payload, access, cab separation



CARRYING PEOPLE
Seating capacity, comfort, access



EXTREME OFF-ROAD
Manoeuvrability, all round visibility, good clearance angles



Key: ■■■■■■ - most desirable ■ - least desirable

[Build & Price](#)

[Print](#)
[Save](#)
[Exit](#)

STEP 1 CHOOSE YOUR BODYSTYLE

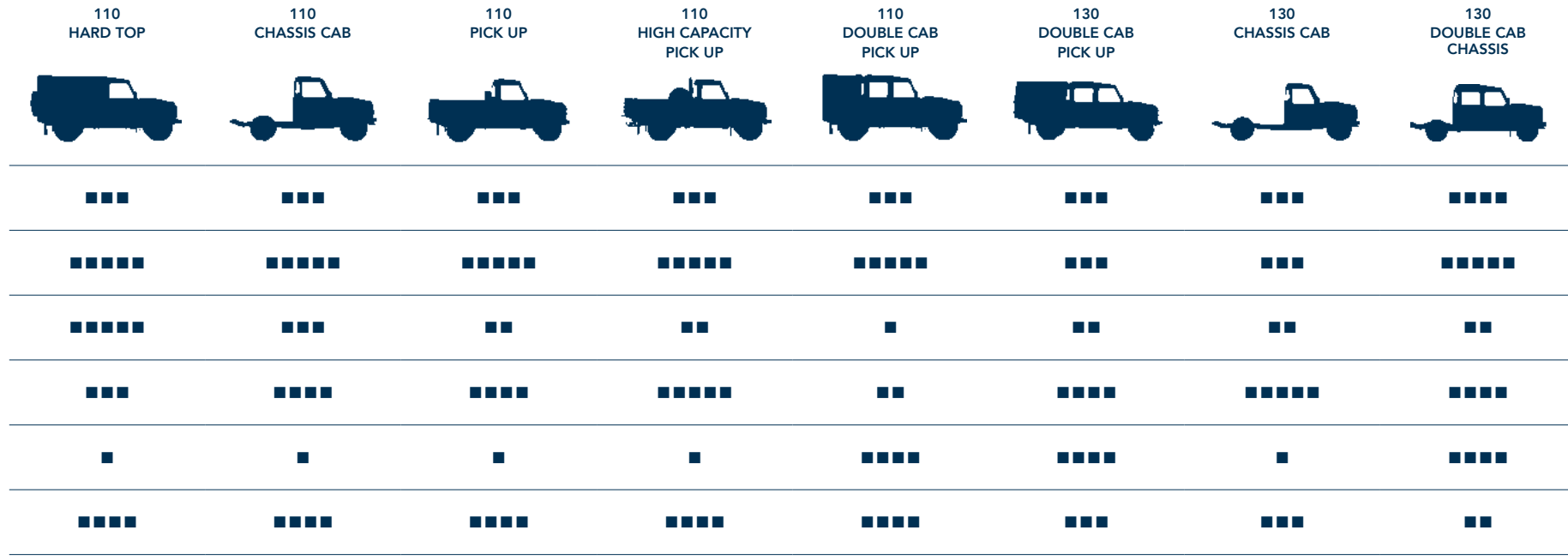

Key: ■■■■■■ - most desirable ■ - least desirable

STEP 1 CHOOSE YOUR BODYSTYLE



[Build & Price](#)

[Print](#)
[Save](#)
[Exit](#)

SEATING

Form follows function in the Defender interior. Tough working vehicles demand robust materials such as the scuff-resistant facia and durable seat coverings. The facia is a one-piece moulding for improved refinement, its distinctive lines providing Land Rover's traditional commanding view of the ground ahead.

The seats are arranged stadium style, their position maximising exterior vision and easing access. Designed to be comfortable and supportive whatever the task or terrain, each seat has a three-point safety harness, but can be folded to optimise the Defender's load-carrying versatility. There's space for smaller items too, in trays on the facia or between the front seats. The optional cubby box provides extra storage and includes two cup holders.



90 HT/PU† Two seats

Rear cabin line applicable to PU only



90 SW† Four seats



110 HT/PU/HCPU† Two seats

Rear cabin line applicable to PU only



110 SW/UW/DCPU† Five seats*

Rear cabin line applicable to DCPU only



110 SW† Seven seats* (optional extra)

Third row rear seats optional



130 DCHCPU† Five seats

ST = Soft Top **HT** = Hard Top **PU** = Pick Up **HCPU** = High Capacity Pick Up **DCPU** = Double Cab Pick Up
SW = Station Wagon **UW** = Utility Wagon **DCHCPU** = Double Cab High Capacity Pick Up
*60:40 split folding middle bench seat (Station Wagon and Utility Wagon only).
†Optional Cubby Box shown.

Please note: Forward-facing seats can carry up to seven adults in comfort. A third row of seats is an optional extra on 110 SW derivatives, standard on 110 SW XS.

[Build & Price](#)

[Print](#)
[Save](#)
[Exit](#)

STEP 1 CHOOSE YOUR BODYSTYLE – STANDARD FEATURES

	HARD TOP	PICK UP	STATION WAGON	UTILITY WAGON	CHASSIS CAB	DOUBLE CAB PICK UP	HIGH CAPACITY PICK UP
ENGINE TRANSMISSION, SUSPENSION AND DRIVING DYNAMICS							
Six-speed transmission with dual range transfer box	■	■	■	■	■	■	■
Permanent four-wheel drive	■	■	■	■	■	■	■
Front axle two-pin differential	■	■	■	■	■	■	■
Power Assisted Steering	■	■	■	■	■	■	■
Standard duty suspension	■	■	■	■	■	■	■
Underseat bottle jack	■	■	■	■	■	■	■
Diesel Particulate Filter (DPF)	■	■	■	■	■	■	■
Anti-lock Braking System (ABS) and Electronic Traction Control (ETC). (Not available on 130 derivatives)	■	■	■	■	■		■
EXTERIOR FEATURES AND FINISHERS							
Exterior Styling							
White roof	■	■					
Grille and headlamp surround – Brunel finish (County and XS derivatives only)	■		■	■		■	
Lower tailgate		■				■	■
Rear mudflaps	■	■	■	■	■	■	■
Rear folding step (standard on HT XS and SW only)	■		■				
Glass and Exterior Mirrors							
Heated rear windscreen	■		■	■			
Tinted front and side glass	■	■	■	■	■	■	■
Windscreen wash/wipe system with variable intermittent function	■	■	■	■	■	■	■
Manually adjustable exterior mirrors	■	■	■	■	■	■	■
Station Wagon roof	■		■	■			
Plain metal side panel (no side window)	■			■			
Rear quarter windows	■		■				
Rear wash wiper	■		■	■			
Headlamps and Lighting							
Halogen headlamps	■	■	■	■	■	■	■
Paint							
Solid paint	■	■	■	■	■	■	■
Wheels and Wheel Options							
16 inch standard steel wheel with Michelin 'Latitude Cross' tubeless tyres ^{1,2}	■	■	■	■		■	■
16 inch heavy duty steel wheel Continental 'Conticross Contact AT' tyres (standard on 130 derivatives only)					■	■	■
Full size spare wheel	■	■	■	■	■	■	■
Locking wheel nuts (XS and County derivatives only)	■		■	■		■	

[Build & Price](#)

[Print](#)
[Save](#)
[Exit](#)

STEP 1 CHOOSE YOUR BODYSTYLE – STANDARD FEATURES

	HARD TOP	PICK UP	STATION WAGON	UTILITY WAGON	CHASSIS CAB	DOUBLE CAB PICK UP	HIGH CAPACITY PICK UP
SEATING, INTERIOR FEATURES AND FINISHERS							
Seating							
Twill Vinyl ³	■	■	■	■	■	■	■
Part Leather (XS models only)	■		■	■		■	
Two front seats only ¹	■	■			■		■
Two individual second row rear seats (90 SW only)			■				
Second row three-seat bench ⁴				■		■	
Two Part Leather third row seats (110 SW XS only)			■				
Interior Finishers							
Graphite Instrument panel insert	■	■	■	■	■	■	■
Rubber floor trim	■	■	■	■	■	■	■
SAFETY AND SECURITY							
Perimetric alarm with engine immobilisation and battery back up sounder	■	■	■	■	■	■	■
Volumetric alarm (includes all standard perimetric features)	■	■	■	■	■	■	■
Volumetric alarm (includes battery back up sounder and all standard perimetric features)	■	■	■	■	■	■	■
CONVENIENCE AND LOADSPACE FEATURES							
Low line stowage tray	■	■	■	■	■	■	■
Two front cup holders	■	■	■	■	■	■	■
Manual dipping interior mirror	■	■	■	■	■	■	■
Driver and passenger sunvisor	■	■	■	■	■	■	■
Rear loadspace net (XS models only)	■		■	■			
Stowage net – rear door (XS Hard Top and Station Wagon derivatives only)	■		■	■			
INFORMATION, COMMUNICATION AND ENTERTAINMENT							
Radio preparation ³	■	■	■	■	■	■	■

¹Not available on 130 derivatives

²Not available on 110 with HD Suspension or XS and County derivatives

³Not available on XS and County derivatives

⁴Not available on 90 derivatives, 110 Pick Up, 110 High Capacity Pick Up and 130 Chassis Cab

STEP 2 CHOOSE YOUR COLOUR

Body Colour

Loire Blue
(Metallic)

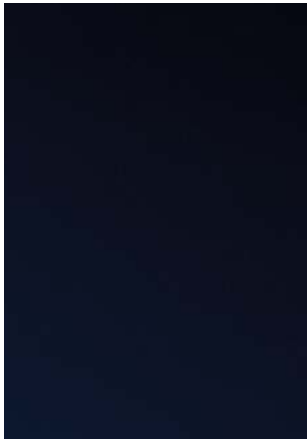

Firenze Red
(Metallic)



Fuji White
(Solid)

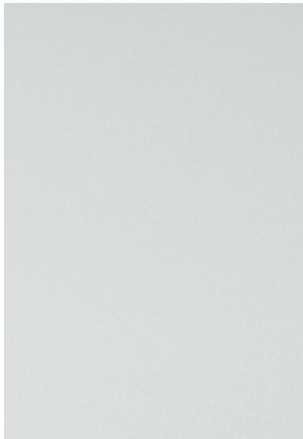

Aintree Green
(Metallic)

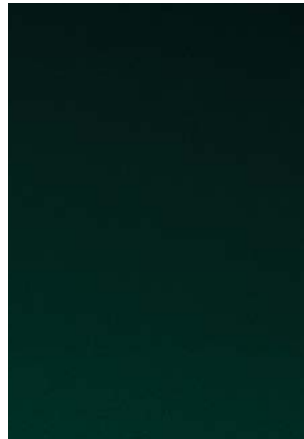

Indus Silver
(Metallic)

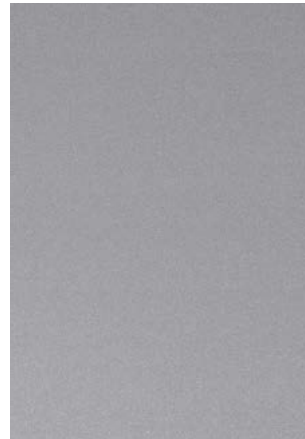

Keswick Green
(Solid)

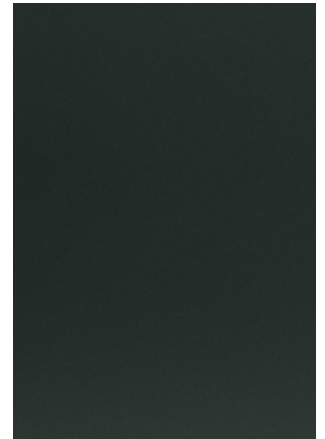

Optional Roof Colour*

Fuji White**

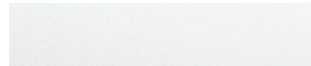
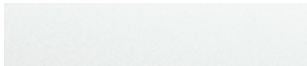

standard

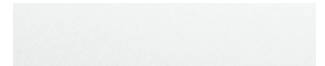
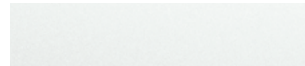
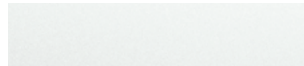

Contrast Santorini Black



Contrast Indus Silver



standard

not available

Contrast Corris Grey



not available



not available

Contrast Firenze Red

not available

standard

not available

not available

not available

not available

Build & Price

Print
Save
Exit

STEP 2 CHOOSE YOUR COLOUR

Body Colour

Corris Grey
(Metallic)



Santorini Black
(Metallic)



Tamar Blue
(Solid)

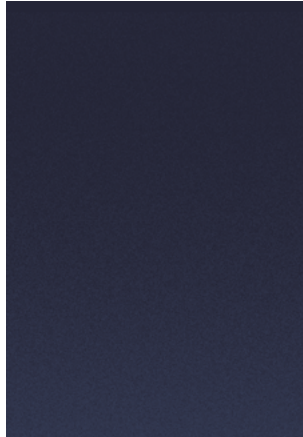

Havana
(Metallic)

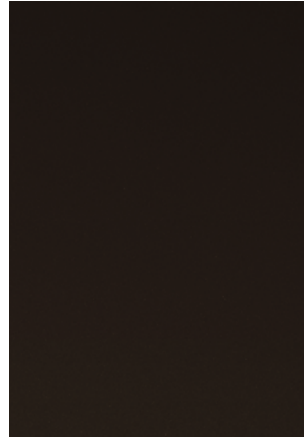

Barolo Black
(Metallic)



Optional Roof Colour*

Fuji White**

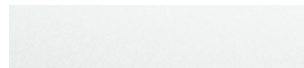
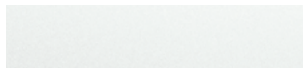
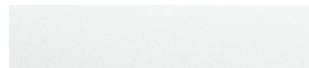
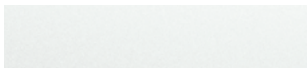

Contrast Santorini Black

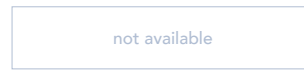
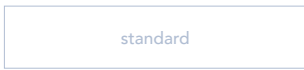

Contrast Indus Silver

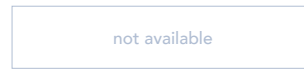
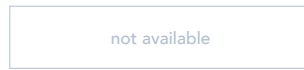
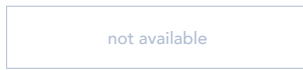

Contrast Corris Grey

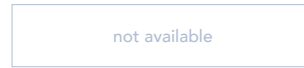
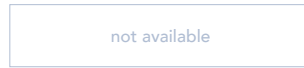
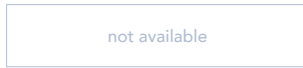
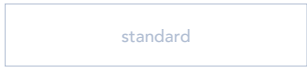

Contrast Firenze Red

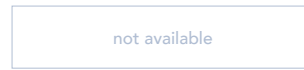
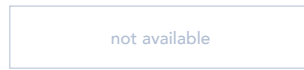
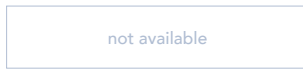
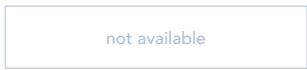

*Not available with 110 Hard Tops
**Fuji White contrast roof not available on County or XS derivatives (unless body colour is also Fuji White).

Build & Price

**Print
Save
Exit**

STEP 3 CHOOSE YOUR WHEELS



STANDARD STEEL WHEEL 5.5F X 16



HEAVY DUTY STEEL WHEEL 6.5J X 16



BOOST ALLOY WHEEL 7J X 16

	90	110	130
WHEELS			
Standard steel wheel	■ ¹	■ ¹	-
Boost alloy wheel	□ ²	□ ²	-
Dual finish alloy wheel	□	□	-
Gloss Black sawtooth alloy wheel*	□	□	-
Heavy duty steel wheel	□	□	■

■ Standard □ Optional - Not Available

For further details on tyre efficiency as required by the EU legislation please speak to your local Land Rover Dealership. When choosing vehicles fitted with specific wheel and tyre combinations or optional wheels and tyres, your intended use of the vehicle should be considered. Alloy wheels may be more vulnerable to damage in some off-road conditions. Please discuss your requirements with your Land Rover Dealership when selecting your vehicle and specification.

*Only available with MT/R tyre.

Build & Price

**Print
Save
Exit**

CHOOSE THE RIGHT TYRE

As experts in off-road capability, Land Rover offer a wide range of tyres with differing performance characteristics allowing you to choose the tyre that best suits your requirements.



DUAL FINISH ALLOY WHEEL 7J X 16



BLACK SAWTOOTH ALLOY WHEEL 7J X 16

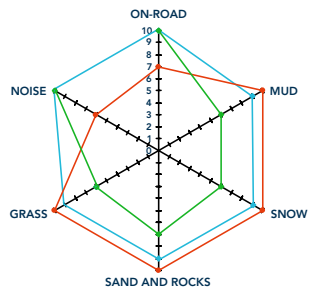

Distance from centre indicates level of performance
1 = Good 10 = Superior

TYRE	WHEEL	TYRE SIZE	90	110	130
MICHELIN LATITUDE CROSS	Std Steel	7.50R16	■ ¹	■ ¹	-
GOODYEAR WRANGLER MT/R	HD Steel	235/85R16	□	□	□
CONTINENTAL CONTICROSS CONTACT AT	HD Steel	235/85R16	-	-	■
CONTINENTAL CONTICROSS CONTACT AT	Alloy	235/85R16	□	□	-
GOODYEAR WRANGLER MT/R	Alloy	235/85R16	□	□	-

■ Standard □ Optional - Not Available HD Heavy Duty

¹Base derivatives only.

²Boost Alloy and Continental Conti Cross Contact AT Tyres standard on 90 XS Hard Top, 90 County Station Wagon and 90 XS Station Wagon.

Build & Price

Print
Save
Exit

STEP 4 CHOOSE YOUR INTERIOR - SEATING FINISHES



[Build & Price](#)

[Print](#)
[Save](#)
[Exit](#)

STEP 4 CHOOSE YOUR INTERIOR - SEATING FINISHES

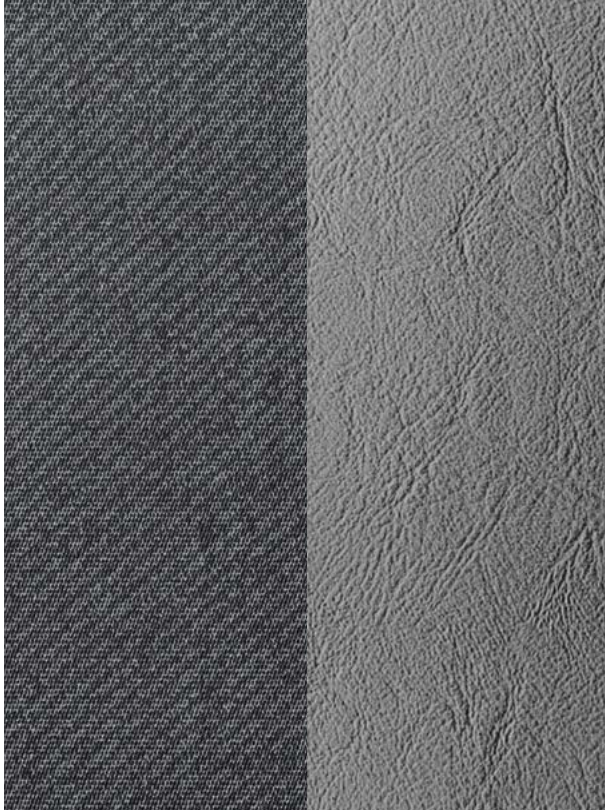

VINYL

Seat face: Twill Vinyl
Seat back and side: Grey Stag Vinyl



CLOTH

Seat face: Black Mondus and Span Cloth



PART LEATHER

Seat face: Black Leather and Rack Three Cloth*

Right for the job and for making the right impression. A selection of stylish, durable trim combinations are available for practicality, comfort and even a touch of luxury.

A part leather premium seat with an embossed Land Rover logo on the headrest is also available.

*Available on XS only.

[Build & Price](#)

[Print](#)
[Save](#)
[Exit](#)

STEP 5 CHOOSE YOUR OPTIONS

Exterior Features and Finishes

	OPTION CODE	HARD TOP	PICK UP	STATION WAGON	UTILITY WAGON	CHASSIS CAB	DOUBLE CAB PICK UP	HIGH CAPACITY PICK UP	LIST PRICE	VAT 20.0%	RETAIL PRICE
EXTERIOR STYLING											
Body-coloured roof ²	080AC	<input type="checkbox"/>	<input type="checkbox"/>	<input type="checkbox"/>	<input type="checkbox"/>	<input type="checkbox"/>	<input type="checkbox"/>	<input type="checkbox"/>	£170.83	£34.17	£205.00
Contrast roof – Indus Silver ²	080AD	<input type="checkbox"/>	<input type="checkbox"/>	<input type="checkbox"/>	<input type="checkbox"/>	<input type="checkbox"/>	<input type="checkbox"/>	<input type="checkbox"/>	£400.00	£80.00	£480.00
Contrast roof – Santorini Black ²	080AN	<input type="checkbox"/>	<input type="checkbox"/>	<input type="checkbox"/>	<input type="checkbox"/>	<input type="checkbox"/>	<input type="checkbox"/>	<input type="checkbox"/>	£400.00	£80.00	£480.00
Contrast roof – Firenze Red ²	080EC	<input type="checkbox"/>	<input type="checkbox"/>	<input type="checkbox"/>	<input type="checkbox"/>	<input type="checkbox"/>	<input type="checkbox"/>	<input type="checkbox"/>	£400.00	£80.00	£480.00
Contrast roof – Corris Grey ²	080EE	<input type="checkbox"/>	<input type="checkbox"/>	<input type="checkbox"/>	<input type="checkbox"/>	<input type="checkbox"/>	<input type="checkbox"/>	<input type="checkbox"/>	£400.00	£80.00	£480.00
Body-coloured wheel arches	080BB	<input type="checkbox"/>	<input type="checkbox"/>	<input checked="" type="checkbox"/>	<input checked="" type="checkbox"/>	<input type="checkbox"/>	<input type="checkbox"/>	<input type="checkbox"/>	£62.50	£12.50	£75.00
Two fixed side steps – 90 derivatives ³	048AX	<input type="checkbox"/>	<input type="checkbox"/>	<input type="checkbox"/>	-	-	-	-	£91.67	£18.33	£110.00
Two fixed side steps – 110 and 130 derivatives ⁴	048AX	<input type="checkbox"/>	<input type="checkbox"/>	-	-	<input type="checkbox"/>	-	<input type="checkbox"/>	£95.83	£19.17	£115.00
Four fixed side steps ⁴	048AY	-	-	<input type="checkbox"/>	<input type="checkbox"/>	<input type="checkbox"/>	<input type="checkbox"/>	-	£195.84	£39.17	£235.00
Folding rear step	048AB	<input type="checkbox"/>	<input type="checkbox"/>	<input checked="" type="checkbox"/>	<input type="checkbox"/>	-	-	<input type="checkbox"/>	£50.00	£10.00	£60.00
Front mudflaps	023AU	<input type="checkbox"/>	<input type="checkbox"/>	<input type="checkbox"/>	<input type="checkbox"/>	<input type="checkbox"/>	<input type="checkbox"/>	<input type="checkbox"/>	£41.67	£8.33	£50.00
Cargo cover/hood – Beige (no side windows) 90 Pick Up	041DA	-	<input type="checkbox"/>	-	-	-	-	-	£254.17	£50.83	£305.00
Cargo cover/hood – Beige (no side windows) 110 Pick Up	041DA	-	<input type="checkbox"/>	-	-	-	<input type="checkbox"/>	-	£295.83	£59.17	£355.00
Cargo cover/hood – Beige (no side windows) High Capacity Pick Up	041DA	-	-	-	-	-	<input type="checkbox"/>	<input type="checkbox"/>	£341.67	£68.33	£410.00
Cargo cover/hood – Black (no side windows) 90 Pick Up	041DC	-	<input type="checkbox"/>	-	-	-	-	-	£337.50	£67.50	£405.00
Cargo cover/hood – Black (no side windows) 110 Double Cab Pick Up	041DC	-	-	-	-	-	<input checked="" type="checkbox"/>	-	£83.33	£16.67	£100.00
Cargo cover/hood – Black (no side windows) 130 Double Cab (HCPU)	041DC	-	-	-	-	-	-	<input type="checkbox"/>	£425.00	£85.00	£510.00
GLASS AND EXTERIOR MIRRORS											
Sunroof	019AB	<input type="checkbox"/>	-	<input type="checkbox"/>	<input type="checkbox"/>	-	-	-	£220.83	£44.17	£265.00
Side protection runners ⁵	048AP	<input type="checkbox"/>	<input type="checkbox"/>	<input type="checkbox"/>	<input type="checkbox"/>	-	<input type="checkbox"/>	-	£300.00	£60.00	£360.00
Under-ride protection bar	042AA	<input type="checkbox"/>	<input type="checkbox"/>	<input type="checkbox"/>	<input type="checkbox"/>	<input type="checkbox"/>	<input type="checkbox"/>	<input type="checkbox"/>	£66.67	£13.33	£80.00
PAINT											
Metallic paint	024AZ	<input type="checkbox"/>	<input type="checkbox"/>	<input type="checkbox"/>	<input type="checkbox"/>	<input type="checkbox"/>	<input type="checkbox"/>	<input type="checkbox"/>	£445.83	£89.17	£535.00
Premium metallic paint	024BR	<input type="checkbox"/>	<input type="checkbox"/>	<input type="checkbox"/>	<input type="checkbox"/>	<input type="checkbox"/>	<input type="checkbox"/>	<input type="checkbox"/>	£816.67	£163.33	£980.00
Premium metallic paint – XS derivatives	024BR	<input type="checkbox"/>	-	<input type="checkbox"/>	<input type="checkbox"/>	-	<input type="checkbox"/>	-	£445.83	£89.17	£535.00
TOWING											
Tow ball with drop plate and electrics	028AK	<input type="checkbox"/>	<input type="checkbox"/>	<input type="checkbox"/>	<input type="checkbox"/>	<input type="checkbox"/>	<input type="checkbox"/>	<input type="checkbox"/>	£254.17	£50.83	£305.00

Visit landrover.co.uk for more information.

Build & Price

Print
Save
Exit

Exterior Features and Finishes

	OPTION CODE	HARD TOP	PICK UP	STATION WAGON	UTILITY WAGON	CHASSIS CAB	DOUBLE CAB PICK UP	HIGH CAPACITY PICK UP	LIST PRICE	VAT 20.0%	RETAIL PRICE
WHEELS AND WHEEL OPTIONS											
Boost alloy wheel with Continental 'ContiCrossContact AT' tyre – 90 derivatives ¹	029PQ	<input type="checkbox"/>	<input type="checkbox"/>	<input type="checkbox"/>	-	-	-	-	£866.67	£173.33	£1,040.00
Boost alloy wheel with Continental 'ContiCrossContact AT' tyre – 110 derivatives ¹	029PQ	<input type="checkbox"/>	<input type="checkbox"/>	<input type="checkbox"/>	<input type="checkbox"/>	-	<input type="checkbox"/>	<input type="checkbox"/>	£679.17	£135.83	£815.00
Boost alloy wheel with Goodyear 'MT/R' tyre – 90 derivatives	029PT	<input type="checkbox"/>	<input type="checkbox"/>	<input type="checkbox"/>	-	-	-	-	£1,079.17	£215.83	£1,295.00
Boost alloy wheel with Goodyear 'MT/R' tyre – 90 County and XS derivatives	029PT	-	-	<input type="checkbox"/>	-	-	-	-	£212.50	£42.50	£255.00
Boost alloy wheel with Goodyear 'MT/R' tyre – 110 derivatives	029PT	<input type="checkbox"/>	<input type="checkbox"/>	<input type="checkbox"/>	<input type="checkbox"/>	<input type="checkbox"/>	<input type="checkbox"/>	<input type="checkbox"/>	£891.67	£178.33	£1,070.00
Boost alloy wheel with Goodyear 'MT/R' tyre – 110 County and XS derivatives	029PT	-	-	<input type="checkbox"/>	<input type="checkbox"/>	-	<input type="checkbox"/>	-	£212.50	£42.50	£255.00
Dual finish alloy wheel with Continental 'ContiCrossContact AT' tyre – 90 derivatives	029PR	<input type="checkbox"/>	<input type="checkbox"/>	<input type="checkbox"/>	-	-	-	-	£1,250.00	£250.00	£1,500.00
Dual finish alloy wheel with Continental 'ContiCrossContact AT' tyre – 90 County and XS derivatives	029PR	<input type="checkbox"/>	-	<input type="checkbox"/>	-	-	-	-	£383.33	£76.67	£460.00
Dual finish alloy wheel with Continental 'ContiCrossContact AT' tyre – 110 derivatives	029PR	<input type="checkbox"/>	<input type="checkbox"/>	<input type="checkbox"/>	<input type="checkbox"/>	<input type="checkbox"/>	<input type="checkbox"/>	-	£1,062.50	£212.50	£1,275.00
Dual finish alloy wheel with Continental 'ContiCrossContact AT' tyre – 110 County and XS derivatives	029PR	-	-	<input type="checkbox"/>	<input type="checkbox"/>	-	<input type="checkbox"/>	-	£383.33	£76.67	£460.00
Dual finish alloy wheel with Goodyear 'MT/R' tyre – 90 derivatives	029PU	<input type="checkbox"/>	<input type="checkbox"/>	<input type="checkbox"/>	-	-	-	-	£1,462.50	£292.50	£1,755.00
Dual finish alloy wheel with Goodyear 'MT/R' tyre – 90 County and XS derivatives	029PU	<input type="checkbox"/>	-	-	-	-	-	-	£595.84	£119.17	£715.00
Dual finish alloy wheel with Goodyear 'MT/R' tyre – 110 derivatives	029PU	<input type="checkbox"/>	<input type="checkbox"/>	<input type="checkbox"/>	<input type="checkbox"/>	<input type="checkbox"/>	<input type="checkbox"/>	-	£1,275.00	£255.00	£1,530.00
Dual finish alloy wheel with Goodyear 'MT/R' tyre – 110 County and XS derivatives	029PU	-	-	<input type="checkbox"/>	<input type="checkbox"/>	-	<input type="checkbox"/>	-	£595.84	£119.17	£715.00
Gloss Black Sawtooth alloy wheel with Goodyear 'MT/R' tyre ⁸	029RS	<input type="checkbox"/>	-	<input type="checkbox"/>	<input type="checkbox"/>	-	-	-	£1,462.50	£292.50	£1,755.00
Heavy Duty steel wheel with Goodyear 'MT/R' tyre ¹⁰	029PS	<input type="checkbox"/>	<input type="checkbox"/>	<input type="checkbox"/>	<input type="checkbox"/>	<input type="checkbox"/>	<input type="checkbox"/>	<input type="checkbox"/>	£300.00	£60.00	£360.00

Seating, Interior Features and Finishers

	OPTION CODE	HARD TOP	PICK UP	STATION WAGON	UTILITY WAGON	CHASSIS CAB	DOUBLE CAB PICK UP	HIGH CAPACITY PICK UP	LIST PRICE	VAT 20.0%	RETAIL PRICE
SEATING											
Two cloth seats (including map pocket on driver's seat)	033AZ	<input type="checkbox"/>	<input type="checkbox"/>	-	-	<input type="checkbox"/>	-	<input type="checkbox"/>	£129.17	£25.83	£155.00
Four cloth seats ¹⁴ (including map pocket on driver's seat)	033AZ	-	-	<input type="checkbox"/>	<input type="checkbox"/>	-	<input type="checkbox"/>	-	£212.50	£42.50	£255.00
Part leather premium front seats ⁸	033MC	<input type="checkbox"/>	-	<input type="checkbox"/>	<input type="checkbox"/>	-	<input type="checkbox"/>	-	£833.33	£166.67	£1,000.00
Remove bulkhead ⁶	059AA	<input type="checkbox"/>	-	■	■	-	-	-	£166.67	£33.33	£200.00
Two vinyl third row seats ⁷	033BI	-	-	<input type="checkbox"/>	-	-	-	-	£533.33	£106.67	£640.00
Two cloth third row seats ⁷	033BI	-	-	<input type="checkbox"/>	-	-	-	-	£533.33	£106.67	£640.00
INTERIOR FINISHERS											
Carpet floor trim ⁹	079AE	<input type="checkbox"/>	-	<input type="checkbox"/>	<input type="checkbox"/>	-	-	-	£129.17	£25.83	£155.00
INTERIOR FEATURES											
Air-conditioning ¹¹	022AM	<input type="checkbox"/>	<input type="checkbox"/>	<input type="checkbox"/>	<input type="checkbox"/>	<input type="checkbox"/>	<input type="checkbox"/>	<input type="checkbox"/>	£895.83	£179.17	£1,075.00
Cubby box – high line in vinyl ¹¹	045AE	<input type="checkbox"/>	<input type="checkbox"/>	<input type="checkbox"/>	<input type="checkbox"/>	<input type="checkbox"/>	<input type="checkbox"/>	<input type="checkbox"/>	£87.50	£17.50	£105.00

¹Standard on County and XS derivatives. ²Not available with 110 Hard Top. Standard on County and XS derivatives. ³Only available with Single Cab derivatives. Not available with side runners. ⁴Only available with Double Cab derivatives. Not available with side runners. ⁵Not available on 110 Hard Top, 110 Pick Up and 130 derivatives. Not available with side steps. ⁶Standard on 90 Station Wagon. ⁷Optional on 110 Station Wagon only. ⁸Only available on XS derivatives. ⁹Only available on XS derivatives.

¹⁰No cost option on County and XS derivatives and 130 derivatives. ¹¹Standard on XS derivatives.

■ Standard □ Optional – Not Available.

Build & Price

Print
Save
Exit

Safety and Security

	OPTION CODE	HARD TOP	PICK UP	STATION WAGON	UTILITY WAGON	CHASSIS CAB	DOUBLE CAB PICK UP	HIGH CAPACITY PICK UP	LIST PRICE	VAT 20.0%	RETAIL PRICE
Speed Limiter – 56 mph / 90 kph	091AB	<input type="checkbox"/>	<input type="checkbox"/>	<input type="checkbox"/>	<input type="checkbox"/>	<input type="checkbox"/>	<input type="checkbox"/>	<input type="checkbox"/>	£66.67	£13.33	£80.00
Speed Limiter – 70 mph / 113 kph	091AC	<input type="checkbox"/>	<input type="checkbox"/>	<input type="checkbox"/>	<input type="checkbox"/>	<input type="checkbox"/>	<input type="checkbox"/>	<input type="checkbox"/>	£66.67	£13.33	£80.00
Speed Limiter – 75 mph / 120 kph	091AD	<input type="checkbox"/>	<input type="checkbox"/>	<input type="checkbox"/>	<input type="checkbox"/>	<input type="checkbox"/>	<input type="checkbox"/>	<input type="checkbox"/>	£66.67	£13.33	£80.00

Information, Communication and Entertainment

	OPTION CODE	HARD TOP	PICK UP	STATION WAGON	UTILITY WAGON	CHASSIS CAB	DOUBLE CAB PICK UP	HIGH CAPACITY PICK UP	LIST PRICE	VAT 20.0%	RETAIL PRICE
Audio system with single slot CD, radio and MP3/AUX (standard on County derivatives)	016AE	<input type="checkbox"/>	<input type="checkbox"/>	<input type="checkbox"/>	<input type="checkbox"/>	<input type="checkbox"/>	<input type="checkbox"/>	<input type="checkbox"/>	£366.67	£73.33	£440.00
Audio system with single slot CD, radio, MP3/AUX and Bluetooth® (standard on XS derivatives)	016AF	<input type="checkbox"/>	<input type="checkbox"/>	<input type="checkbox"/>	<input type="checkbox"/>	<input type="checkbox"/>	<input type="checkbox"/>	<input type="checkbox"/>	£541.67	£108.33	£650.00
Audio System with single slot CD, radio with MP3/AUX and Bluetooth® – County derivatives (standard on XS derivatives)	016AF	–	–	<input type="checkbox"/>	<input type="checkbox"/>	–	<input type="checkbox"/>	–	£175.00	£35.00	£210.00
Audio System Upgrade (subwoofer mounted on front centre console storage compartment and dashboard mounted tweeter) – XS derivatives	025LY	–	–	<input type="checkbox"/>	<input type="checkbox"/>	–	–	–	£150.00	£30.00	£180.00

Exterior Features and Finishes

	OPTION CODE	HARD TOP	PICK UP	STATION WAGON	UTILITY WAGON	CHASSIS CAB	DOUBLE CAB PICK UP	HIGH CAPACITY PICK UP	LIST PRICE	VAT 20.0%	RETAIL PRICE
Cold Climate Pack – consists of heated front seats and heated windscreen ¹	072AC	<input type="checkbox"/>	<input type="checkbox"/>	<input type="checkbox"/>	<input type="checkbox"/>	<input type="checkbox"/>	<input type="checkbox"/>	<input type="checkbox"/>	£341.67	£68.33	£410.00
Convenience Pack – consists of electric front windows and remote central locking ²	074GQ	<input type="checkbox"/>	<input type="checkbox"/>	<input type="checkbox"/>	<input type="checkbox"/>	<input type="checkbox"/>	<input type="checkbox"/>	<input type="checkbox"/>	£375.00	£75.00	£450.00
Comfort Pack – consists of Convenience Pack, air-conditioning and audio system with single slot CD, radio and MP3/AUX	074HM	<input type="checkbox"/>	<input type="checkbox"/>	–	–	<input type="checkbox"/>	–	<input type="checkbox"/>	£1,375.00	£275.00	£1,650.00
Roof Appointment Pack – consists of rear quarter glass windows and Station Wagon roof ³	060AA	<input type="checkbox"/>	–	–	–	–	–	–	£212.50	£42.50	£255.00
Exterior Pack – consists of front mudflaps, Roof Appointment Pack, body-coloured roof, side steps, rear folding step and body-coloured wheel arches ³ (standard on XS derivative, not available with Style Pack)	031CK	<input type="checkbox"/>	–	–	–	–	–	–	£379.17	£75.83	£455.00
Style Pack – consists of boost alloy wheel and Continental Conti Cross Contact AT Tyre, front and rear anti-roll bar, locking wheel nuts, side runners, tow ball, drop plate and electrics ⁴ (not available with Exterior Pack)	036JM	<input type="checkbox"/>	<input type="checkbox"/>	–	–	–	–	–	£1,158.33	£231.67	£1,390.00

¹Constituent parts standard on XS derivatives ²Constituent parts standard on County and XS derivatives ³Only available on 90 Hard Top

⁴Only available on 90 Hard Top and Pick Up derivatives. Not available with any other wheels and tyres

■ Standard □ Optional Δ No Cost Option – Not Available.

The Bluetooth® word mark and logo are owned by the Bluetooth SIG, Inc. and any use of such marks by Land Rover is under licence.

Visit landrover.co.uk for more information.

Build & Price

Print
Save
Exit

DIMENSIONS AND CAPABILITIES



[Build & Price](#)

[Print](#)
[Save](#)
[Exit](#)

DIMENSIONS AND CAPABILITIES



Departure angle

Ramp angle

Approach angle

MAXIMUM GRADIENT

	90	110	130
Maximum gradient	45°	45°	45°

GROUND CLEARANCE MM (inches)

	90	110	130
Tyre size	235/85R16	235/85R16	7.50R16
Axle ground clearance	250 (9.8)	250 (9.8)	250 (9.8)
Minimum underbody ground clearance, unladen	323 (12.72)	314 (12.36)	314 (12.36)

GRADIENTS AT KERB WEIGHT

	90	110	130
Departure angle	47.1°	35.6°	35.2°
Ramp break	147°	149.7°	152.5°
Approach angle	47°	48.7°	49°

[Build & Price](#)

[Print](#)
[Save](#)
[Exit](#)

DIMENSIONS AND CAPABILITIES



WADING DEPTH MM (inches)

	90	110	130
Maximum wading depth	500 (20)	500 (20)	500 (20)

TURNING CIRCLE Kerb-to-Kerb metres (feet)

	90	110	130		
Tyre size	7.50R16	235/85R16	7.50R16	235/85R16	7.50R16
Minimum turning diameter	12.3 (40.4)	13.34 (43.8)	12.8 (42.0)	14.4 (47.3)	15.08 (49.4)

BRAKES

Servo assisted front and rear disc brakes on all models.

STEERING

All models have power assisted steering. Worm and roller.

[Build & Price](#)

[Print](#)
[Save](#)
[Exit](#)

DIMENSIONS AND CAPABILITIES



[Build & Price](#)

[Print](#)
[Save](#)
[Exit](#)

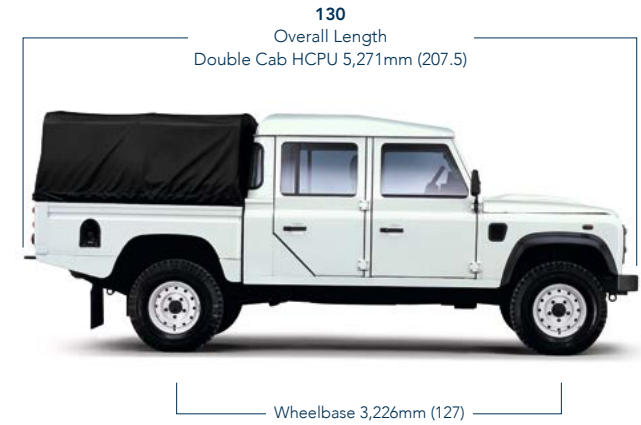
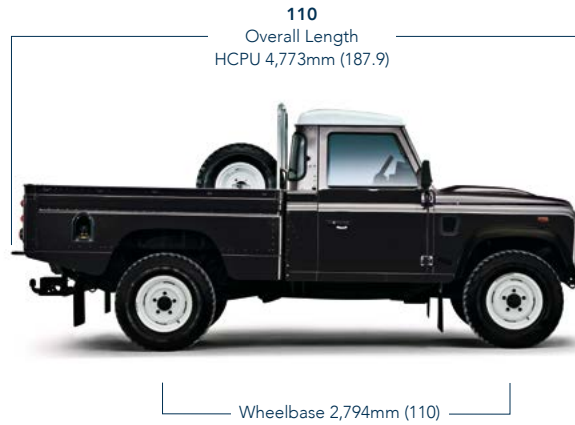
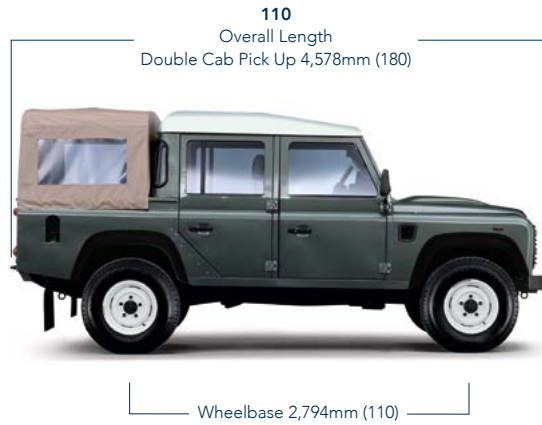
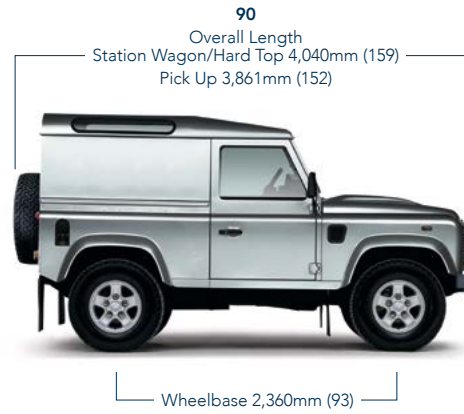
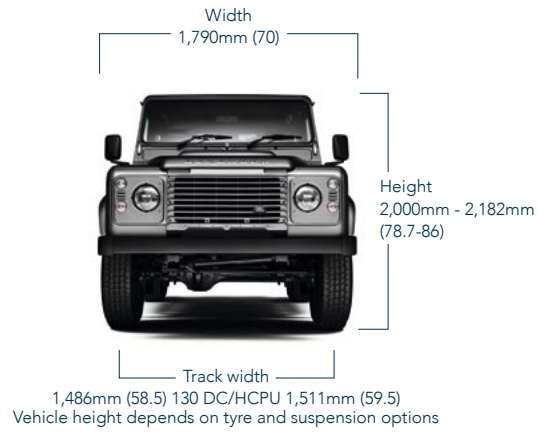

	90			110				130	
	Pick Up	Hard Top	Station Wagon	Pick Up	High Capacity Pick Up	Hard Top	Station Wagon	Double Cab	Double Cab HCPU
Track front/rear	1,486 (58.5) [†]	1,486 (58.5) [†]	1,486 (58.5) [†]	1,486 (58.5) [†]	1,486 (58.5) [†]	1,486 (58.5) [†]	1,486 (58.5) [†]	1,486 (58.5) [†]	1,511 (59.5)
Cargo bed length	983* (38.7)	1,144 (45.0)	1,144 (45.0)	1,740* (68.5)	1,986 (78.2)	1,900 (74.8)	1,900 (74.8)	1,020 (40.8)	1,680* (66.1)
Tailgate aperture width	878 (34.5)	878 (34.5)	878 (34.5)	878 (34.5)	1,362 (53.6)	878 (34.5)	878 (34.5)	878 (34.5)	1,362 (53.6)
Largest box length	830 (32.6)	1,030 (40.6)	1,005 (40)	1,570 (61.8)	1,980 (78)	1,750 (68.9)	1,100/1,470 (43.5/57.9)**	690 (27.2)	1,640 (64.6)
Largest box width	800 (31.5)	755 (29.7)	660 (26)	800 (31.5)	1,060 (41.7)	755 (29.7)	660 (26)	800 (31.5)	1,060 (41.7)
Largest box height	1,160 (45.7)	1,050 (41.3)	1,050 (41.3)	1,160 (45.7)	1,160 (45.7)	1,050 (41.3)	1,050 (41.3)	1,160 (45.7)	1,160 (45.7)

Dimensions mm (inches) *Add 161mm if spare wheel removed **2nd row seats up/2nd row seats folded [†]Due to greater wheel offset 1,511 (59.5) when HD Steel Wheel and Gloss Black Saw Tooth Alloy Wheel is fitted

[Build & Price](#)

[Print](#)
[Save](#)
[Exit](#)

TECHNICAL SPECIFICATION, PERFORMANCE AND KEY DATA

Vehicle Loading

Incorrect vehicle and trailer loading can give poor vehicle handling and braking performance and a generally unstable and inefficient vehicle.

Payload and Weight Distribution

A correct weight distribution is achieved by considering several simple points:

- Payload is calculated by GVW – EEC kerb weight and must not be exceeded
- This payload should be distributed as evenly as possible along the vehicle's loadbed length
- The height of the payload should be kept to a minimum to keep the centre of gravity as low as possible
- Additional effects of a trailer should be taken into consideration (see towing section below).

Please refer to the Weights table opposite and the dimensions section to assess the most appropriate vehicle configuration for the loads you are likely to carry.

Towing

Choosing the correct equipment

Land Rover offers a range of towing equipment to suit different applications, both as optional original equipment and accessories. Multi-height tow bars enable the tow ball to be fitted in three different positions to suit different trailer towing requirements.

Adjustable tow bars enable the tow ball to be readily adjusted to different heights and are suitable for users who are likely to tow a variety of different trailers, or where the rear height of the vehicle may vary significantly with different payloads.

Roof Racks

Any load on the roof of the vehicle will affect vehicle handling and significant or tall loads should be avoided. Land Rover recommends a maximum of 150kg including the roof rack. Land Rover Accessories and Land Rover Professional Vehicles offer a range of roof rack systems to ensure roof loads are carried as safely as possible. Please refer to the accessories section of this brochure or your Land Rover Dealership for more information.

Engine and Transmission

2.2 LITRE DIESEL

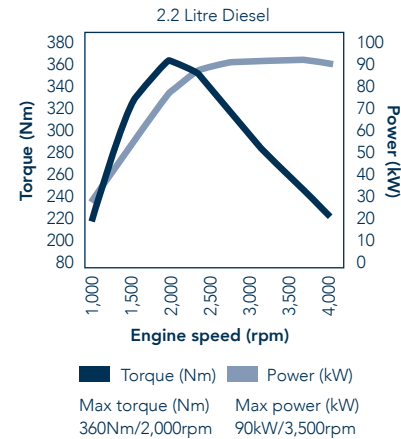

ENGINE DATA

Location	Longitudinal
Capacity (cc)	2,198
No. of cylinders	4
Valves per cylinder	4
Cylinder layout	North-South
Bore (mm)	86
Stroke (mm)	94.6
Compression ratio (:1)	15.64
Cylinder head material	Aluminium
Cylinder block material	Cast Iron
Maximum power kW (PS) @ rpm	90 (122) @ 3,500
Maximum torque Nm @ rpm	360 @ 2,000

FUEL TANK CAPACITY	90	90 SW	110	130
Litres	60	60	75	75

FUEL ECONOMY	90	90 SW	110	130
Urban mpg (L/100km)	24.6 (11.5)	24.1(11.7)	20.8 (13.6)	20.8 (13.6)
Extra Urban mpg (L/100km)	31.0 (9.1)	30.1 (9.4)	29.1 (9.7)	29.1 (9.7)
Combined mpg (L/100km)	28.3 (10.0)	27.7 (10.2)	25.5 (11.1)	25.5 (11.1)
Drive by noise	75dB (A)	75dB (A)	75dB (A)	75dB (A)
CO ₂ Combined emissions (g/km)	266	269	295	295
Certifiable emissions	EU5	EU5	EU5	EU5
Maximum speed mph (kph)	90 (145)	90 (145)	90 (145)	90 (145)
Acceleration 0-60mph in seconds	14.7	14.7	14.7	15.7
Acceleration 0-100kph in seconds	15.8	15.8	15.8	17

The figures provided are as a result of official manufacturer's tests in accordance with EU legislation. A vehicle's actual fuel consumption may differ from that achieved in such tests and these figures are for comparative purposes only. Vehicles are not individually tested, and there are inevitably differences between individual vehicles of the same model. Furthermore, the incorporation of particular modifications, the driver's style and road traffic conditions, as well as the extent to which the vehicle has been driven and the standard of maintenance will all affect its fuel consumption.

Build & Price

Print
Save
Exit

TECHNICAL SPECIFICATION, PERFORMANCE AND KEY DATA

Load Capabilities

TOWING (KG)

	90	110	130
Braked trailer	3,500	3,500	3,500
Unbraked trailer	750	750	750
Recommended max. trailer nose weight	150	150	150
Effect on rear axle weight	201	204 (HCPU 215)	206

MAXIMUM AXLE (KG)

	90	110	130
Front axle	1,250	1,250	1,580
Rear axle	1,500	1,980	2,200
Gross vehicle weight	2,505	3,050	3,380

ROOF LOAD SYSTEM (KG)

	90/110/130
Roof rack	150
Ladder rack	150

Approved Land Rover Genuine Parts roof rack.
Weight shown is maximum load, includes roof rack.

Suspension

	90	110	130 HEAVY DUTY
Front	Live beam axle, linear rate coil springs, coaxial telescopic Nitrogen-charged hydraulic dampers. Panhard rod and Radius arms. Anti-roll bar if alloy wheels fitted.	Live beam axle, dual rate coil springs, coaxial telescopic Nitrogen-charged hydraulic dampers. Panhard rod and Radius arms. Anti-roll bar.	Live beam axle, linear rate coil springs, coaxial telescopic Nitrogen-charged hydraulic dampers. Panhard rod and Radius arms. Anti-roll bar.
Rear	Live beam axle, dual rate coil springs, telescopic Nitrogen-charged hydraulic dampers. 'A' frame and Trailing Links. Anti-roll bar if alloy wheels fitted.	Live beam axle, triple rate coil springs, telescopic Nitrogen-charged hydraulic dampers. 'A' frame and Trailing Links. Anti-roll bar.	Live beam axle, triple rate coil springs, coaxial linear rate helper springs, telescopic Nitrogen-charged hydraulic dampers. 'A' frame and Trailing Links. Anti-roll bar.

Weights (kg)

	90			110					130				
STANDARD	Pick Up	Hard Top	Station Wagon	Pick Up	High Capacity Pick Up	Hard Top	Station Wagon 5 seat/ 7 seat	Utility Wagon	Double Cab Pick Up	Chassis Cab	Double Cab HCPU	Chassis Cab	Double Cab Chassis
Gross vehicle	2,505	2,505	2,505	3,050	3,050	3,050	3,050/3,050	3,050	3,050	3,050	3,380	3,500	3,380
Minimum kerb weight*	1,740	1,771	1,887	1,917	1,938	1,955	2,062/2,123	2,062	2,042	1,787	2,149	1,858	2,024
Maximum payload**	765	734	618	1,133	1,112	1,095	988/927	988	1,008	1,263	1,231	1,642	1,356

*Minimum kerb weight = Unladen weight + full tank and 75kg driver **Maximum payload = GVW – Kerb weight

[Build & Price](#)

[Print](#)
[Save](#)
[Exit](#)

ACCESSORIES



[Build & Price](#)

[Print](#)
[Save](#)
[Exit](#)

Touring



Expedition Roof Rack System**

VPLDR0063 – 90 Hard Top/Station Wagon **£883.00**

VPLDR0064 – 110 Hard Top/Station Wagon (not shown) **£1,080.00**

VPLDR0065 – 110/130 Double Cab (not shown) **£868.00**

Heavy duty rack system secured by clamps to the roof gutter.



Two Part Rear Access Ladder
AGP710010 **£215.00**

For use with Expedition Roof Racks VPLDR0063 and VPLDR0064.



Ribbed Aluminium Undershield
LR008247 **£497.00**

Helps to provide under-engine protection when driving off-road.



Black Leather Hand Brake, Gear and Transfer Lever Gaiters
VPLDS0258 **£347.15**

Grained Leather Gaiter covers detailing ebony coloured twin stitch features.



Moulded Wheel Cover
STC7889 **£114.00**

Styled spare wheel cover fits most wheel sizes.



Cargo Barrier*

Designed to help prevent cargo and luggage from entering the passenger compartment. Manufactured in Black nylon coated steel and easy to remove when not required. Please note: ECE R17 compliant.

LR006785* – Cargo Barrier – 90/110HT (not shown) **£143.18**

LR006447 – Cargo Barrier – 110SW **£273.74**

LR006448* – Cargo Barrier – 90SW (not shown) **£271.33**

*2007 Model Year vehicles onwards.

**Maximum permissible load capacity minus the weight of the roof mounted accessory.

Prices correct to 30th June 2014. All prices subject to change.

Please contact your dealer for the latest pricing. Prices include VAT but exclude dealer fitting costs.

[Build & Price](#)

[Print](#)
[Save](#)
[Exit](#)

Sporting



Side Protection Runners – Twin Tube**

VPLDP0006 – Stainless Steel – Defender 90 **£698.00**

VPLDP0067 – Black Finish – Defender 110SW and Double Cab (not shown) **£490.48**

VPLDP0068 – Black Finish – Defender 90SW (not shown) **£413.88**



Raised Air Intake
LR008383 **£474.00**

Ideal for dusty conditions, this raised air intake secures to the vehicle's 'A' post and also utilises the existing air intake vent fixings. Suitable for Td5, 2.4 and current 2.2 diesel engines.

Please note: Not compatible with SVX Soft Top model.



Sports Bar System*
STC7582 **£207.00**

A high leg design which extends the carrying potential for a variety of equipment. The sports bars can accommodate a range of attachments, including roof boxes and special carriers for various sports equipment. Vehicle height when fitted 2,088mm (90SW) and 2,141mm (110SW). Maximum payload 75kg**.



Luggage Box*
VPLVR0062 **£535.00**

Opens from both sides. Lockable for security. Volume 410 litres. Maximum payload 75kg**.



Folding Side Step
STC7631 **£94.00**

Spring-loaded folding step helps makes access to the interior of your Defender easier. Supplied with fitting kit. For all Defender models.



Rear Step Bumper

Makes access to the loadspace easy as well as helping to provide added protection from minor knocks, and also incorporates a dual height tow bracket.

STC50269AA – Defender 90 **£417.00**

STC50301 – Defender 110 (not shown) **£417.00**

Outdoor



9.5CTI Electric Winch
VPLDP0113 £2000.00

Rated capacity of 9,500lb/4,310kg, 38 metres x 8mm diameter wire rope. This powerful electric winch is designed to fit easily to the front of your Defender, even if the air conditioning option is fitted. Offering maximum reliability for all general winching and self recovery requirements, the winch is available as a complete vehicle kit, ensuring specification and installation are straightforward.



Chequer Plate Protection Kit

Features sill edge and rear corner protectors and two front bumper step plates. **STC50245** – Defender 90SW, Silver **£415.00**. **STC50381** – Defender 110SW – except HCPU – Silver (not shown) **£430.00**.

Please note: Front bumper step plates are not compatible with PIAA Driving Lamp Kit (LR006815).



Wing Top Protectors

Manufactured in an aluminium chequer plate design, these enable access to roof racks and a potential viewing height advantage.

LR005230 – Silver (2007 Model Year vehicles onwards) **£273.00**



Worklight
RTC8921AA £74.00

Enables your Defender to provide floodlight style illumination when working in reduced lighting conditions. Fits both 90 and 110 models. Switches, cables and brackets are supplied in the kit.



A-Frame Protection Bar – Non winch version
VPLPP0060† £559.00

A-Frame Protection Bar – Winch version (not shown)
VPLPP0061† £611.00

Manufactured from durable polymer, suitable for models with or without air conditioning.



Front Mudflaps
RTC9479 £76.00

Heavy duty moulded Mudflaps reduce spray and help protect vehicle paintwork. Mudflaps, front pair for 90 and 110 models only.

*Sports Bar System (STC7582) is required for all Land Rover roof-mounted accessories **Maximum permissible load capacity minus the weight of the roof mounted accessory †Compliant to EEC Directive 2005/66. Prices correct to 30th June 2014. All prices subject to change. Please contact your dealer for the latest pricing. Prices include VAT but exclude dealer fitting costs.

Build & Price

**Print
Save
Exit**

Style



Side Protection Runners

LR008379 – Black Finish – Defender 90 **£481.32**

LR008375 – Black Finish – Defender 110 (not shown) **£553.67**

The sturdy steel design enhances the appearance of your Defender as well as helping to ease entry and exit. The moulded rubber footgrips help to ensure non-slip stability.



Union Flag Bonnet and Side Decals

VPLDB0146LKH – Corris Grey **£204.00**

Union Flag Bonnet and Side Decals offer an exterior styling upgrade with a distinctively British twist. Tested to exacting Land Rover standards to ensure resistance to fading or peeling over time. Recommended exterior colour combinations: Corris Grey Decals with Santorini Black, Fuji White or Indus Silver body colours. Santorini Black Decals with Orkney Grey or Corris Grey body colours.



Union Flag Side Decal - Corris Grey



Recaro Front Seat Kit

VPLDS0036PUY – Left-hand seat **£2,430.00**

VPLDS0035PUY – Right-hand seat (not shown) **£2,430.00**

Heated seat with cloth seat facings and leather surround, featuring Land Rover and Recaro embossed logos. Installation kit included. Not compatible with vehicles fitted with a bulkhead or 90 bulkhead deleted vehicles with jack storage brackets behind the front seats. Applicable VIN WA138480 110SW, 110 and 130 Double Cab and 9A773310 90 vehicles with bulkhead deleted.

Compatible with vehicles fitted with heated seat option. Supplied individually.



Style Valve Caps

LR027560 – Land Rover **£20.00**

LR027664 – Union Jack **£26.40**

LR027666 – Black Jack **£20.00**



Ebony Black Carpet Mat Set With Silver Land Rover Ingot

VPLDS0240 **£78.00**

Includes mats for the front and folding middle/rear seat footwells. The carpet mats have matching ebony suede effect piping and a silver Land Rover ingot. These durable mats come fitted with protective rubber backing.

Ebony Black Carpet Mats With Silver Land Rover Ingot – Front

VPLDS0241 **£108.00**

Ebony carpet mat for the front seat footwells only.

[Build & Price](#)

[Print](#)
[Save](#)
[Exit](#)

Other



Multi-height Tow Bar**

This cost-effective design gives a range of towing heights to suit different trailers and contains a towing armature, multi-height face plate and 50mm tow ball.

VPLDT0084 – Defender 90 **£215.00**

VPLDT0085 – Defender 110 (except HCPU) (not shown) **£249.00**

VPLDT0086 – Defender 130 and HCPU **£258.00**



Adjustable Tow Bar**

Copes with different trailer coupling heights without the need for any tools and comprises of a towing armature, sliding plate and security pin.

LR007221 – Defender 90 **£221.00**

LR007222 – Defender 110 (not shown) **£221.00**

LR007223 – Defender 130 and 110 HCPU (not shown) **£300.00**



13 Pin Towing Electrics* LR005919 **£137.00**

European style towing electrics, capable of supplying all trailer rear lighting and interior equipment power, including fridge feed and battery charging.



Combination Tow Ball/Jaw Unit** LR008244 **£177.00**

50mm tow ball and jaw combination for increased towing versatility and a 3,500kg capacity.



Tow Ball** RTC8891AA **£20.00**

50mm Tow Ball.



'S' Type Towing Electrics* LR005921 – (shown above, left-hand side) **£115.00**

For use when additional trailer power is required. Capable of supplying interior lighting and equipment power including fridge feed and battery charging. Please note: Not compatible with standard fitted 12N sockets. Must be used in conjunction with 'N' Type Towing Electrics LR005920.

'N' Type Towing Electrics* LR005920 – (shown above, right-hand side) **£91.00**

Provides power for rear trailer lighting including rear lamps, brake lamps, direction indicators and high intensity fog lamp(s). Can also power a Lighting Board.

*These accessories are not suitable for Caravans, Trailers or Lighting Boards fitted with rear mounted LED Lamps.

For information relating to load capabilities, please refer to the **Technical Specifications page.

Prices correct to 30th June 2014. All prices subject to change. Please contact your dealer for the latest pricing. Prices include VAT but exclude dealer fitting costs.

Build & Price

**Print
Save
Exit**



[Build & Price](#)

[Print](#)
[Save](#)
[Exit](#)



BY APPOINTMENT TO
H.M. THE QUEEN
MANUFACTURERS OF
MOTOR VEHICLES
JAGUAR LAND ROVER LIMITED
COVENTRY



BY APPOINTMENT TO
H.R.H. THE DUKE OF EDINBURGH
MANUFACTURERS OF
MOTOR VEHICLES
JAGUAR LAND ROVER LIMITED
COVENTRY



BY APPOINTMENT TO
H.R.H. THE PRINCE OF WALES
MANUFACTURERS OF
MOTOR VEHICLES
JAGUAR LAND ROVER LIMITED
COVENTRY

IMPORTANT NOTICE: Jaguar Land Rover Limited is constantly seeking ways to improve the specification, design and production of its vehicles and alterations take place continually. Whilst every effort is made to produce up to date literature, this brochure should not be regarded as an infallible guide to current specifications, nor does it constitute an offer for the sale of any particular vehicle. Distributors and dealers are not agents of Jaguar Land Rover Limited by any express or implied undertaking or representation.

All Land Rover Approved Accessories fitted by a Land Rover Dealer within one month or 1,600 kilometres/1,000 miles (which ever occurs first) of the handover of a new registered vehicle will benefit from the same warranty terms and period of cover as the vehicle warranty. Accessories purchased outside of these parameters will be subject to a 12 month unlimited mileage warranty. All Land Rover Approved Accessories are rigorously tested to the same exacting standards as those applied to our vehicles. Performance in extreme hot and cold temperatures, corrosion resistance, impact and airbag deployment highlight some of the exhaustive product testing carried out to ensure accessories are both durable and importantly, continue to comply with current legislation.

All our accessories are designed to be an integral part of Land Rover vehicles. While many items such as roof carriers are simple to fit, some products require specialist tools and diagnostic equipment to ensure correct integration with the vehicle structure and electrical systems. These products vary from market to market, please consult your Land Rover Dealer who will be pleased to advise you on current specifications and any query you may have.

The colours reproduced here are subject to the limitations of the printing process and may therefore vary slightly from the actual vehicle. The company reserves the right to alter or withdraw any colour finish without notice. Some of these colours may not be obtainable in your country. Please check availability of colours and current specifications with your Land Rover Dealer. Distributors and dealerships are not agents of Jaguar Land Rover Limited and have absolutely no authority to bind Jaguar Land Rover Limited to any express or implied undertaking or representation.

Jaguar Land Rover Limited Registered Office:

Abbey Road, Whitley, Coventry CV3 4LF

United Kingdom.

Registered in England and Wales: Number 1672070

landrover.co.uk

© Jaguar Land Rover Limited 2013.

Keep me informed



Build & Price

**Print
Save
Exit**