

RANGE ROVER SPORT



ABOVE AND BEYOND



NOW IT'S TIME TO CHOOSE...

The all-new Range Rover Sport offers an exclusive range of options that allow you to personalise your vehicle. The following pages take you through a logical series of steps to make it a true expression of your individuality. You have several choices: from selecting your engine and model to exterior and interior colours, wheels, finishes and those detailed touches that define your style.

If you'd like to bring your options to life, go to our online configurator at landrover.co.uk



Step 1

Hybrid

The world's first Diesel Hybrid SUV.

Choose your engine

You can select from a powerful range of petrol or diesel engines including the new hybrid diesel engine.

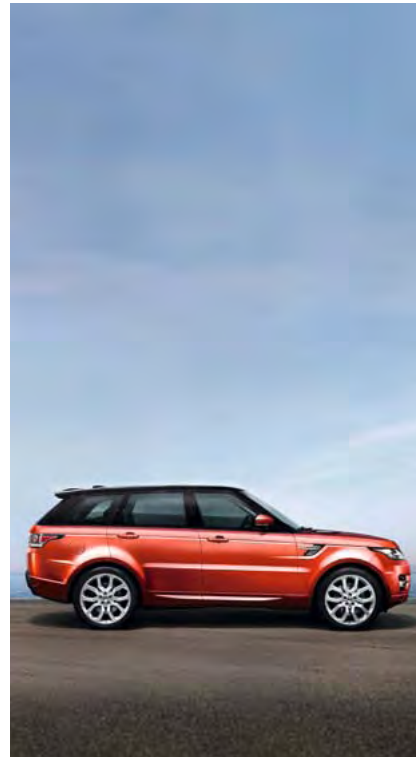

Step 2

Choose your model

Compare the standard features on each model.

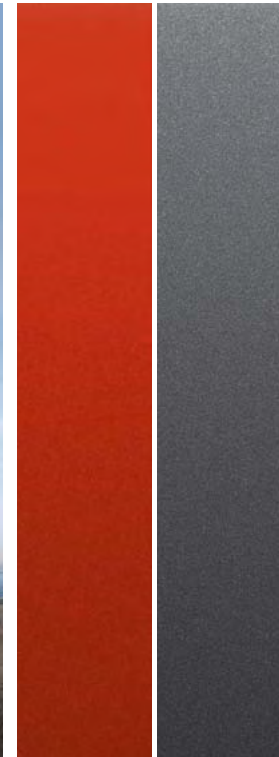

Step 3

Choose your colour

There's a wide range on offer to enable you to express yourself.

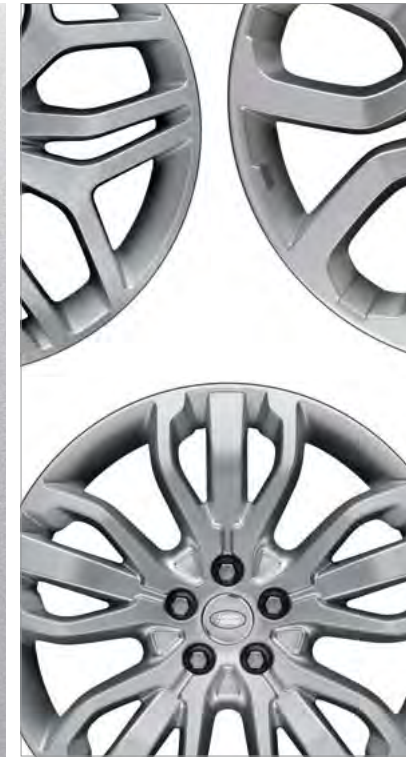

Step 4

Choose your wheels

There's a range of styles, each one designed to complement the bold exterior.

[Build & Price](#)

[Print](#)
[Save](#)
[Exit](#)

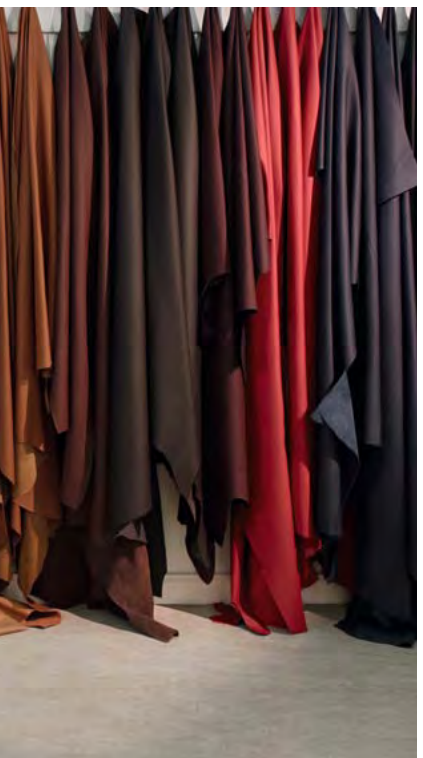

Step 5
Choose your interior

Carefully selected colours complemented by the finest metals and real wood veneers. You can personalise your own interior space.



Step 6
Choose your options

Additional options can enhance your personal requirements.



Key Features

The latest innovations that make your vehicle a pleasure to drive.



Technical Details

Technical information and data for dimensions, performance and specifications.

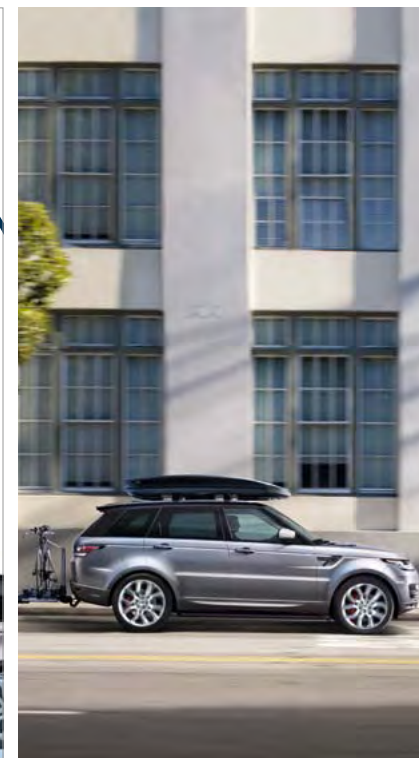

Accessories

Additional accessories can enhance your personal requirements.

Build & Price

**Print
Save
Exit**

RANGE ROVER SPORT HYBRID

All-new Range Rover Sport Hybrid* is the first diesel SUV of its kind in the world. It has been designed and engineered to deliver class-leading capability and versatility. By fully integrating the hybrid technologies into the chassis, nothing has been lost in ground clearance, approach and departure angles or the 850mm wading depth. The vehicle truly is 100% Hybrid, 100% Land Rover.

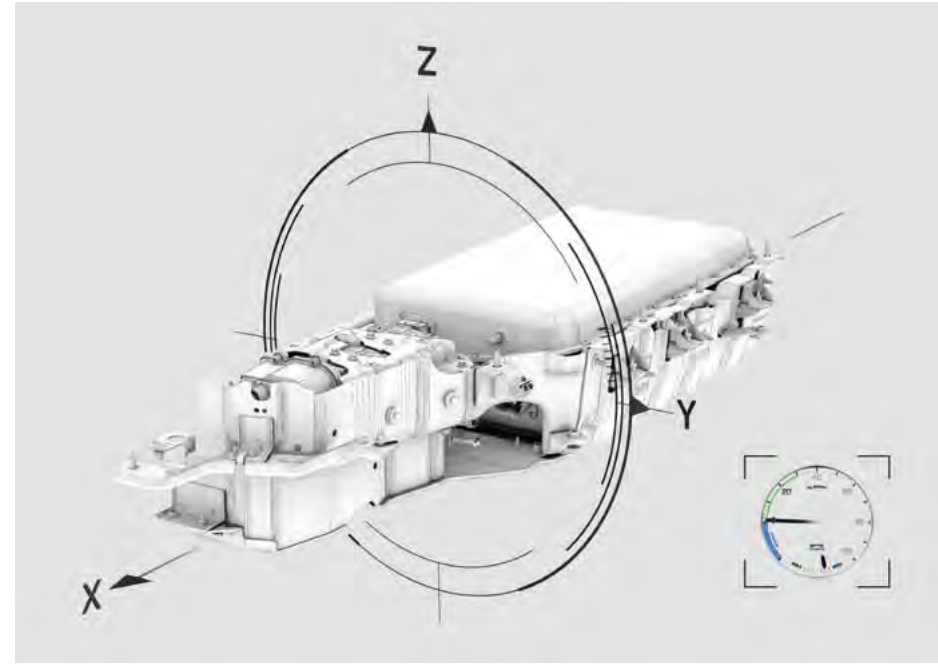

All-new Range Rover Sport Hybrid has been tested on the most demanding terrains, rigs and under the same extremes as every Land Rover. Whilst nothing has been lost in the responsiveness of the drive, hybrid technologies deliver impressive efficiencies. The 3.0L SDV6 Diesel engine with a 35kW electric motor generates an impressive 700Nm of torque resulting in the same performance as the SDV8 Diesel but with 15% lower (30g/km less) CO₂ emissions when compared to the SDV6 engine at 169g/km.

*Please contact your local Land Rover Dealership regarding SDV6 Hybrid engine availability.

[Build & Price](#)

[Print](#)
[Save](#)
[Exit](#)

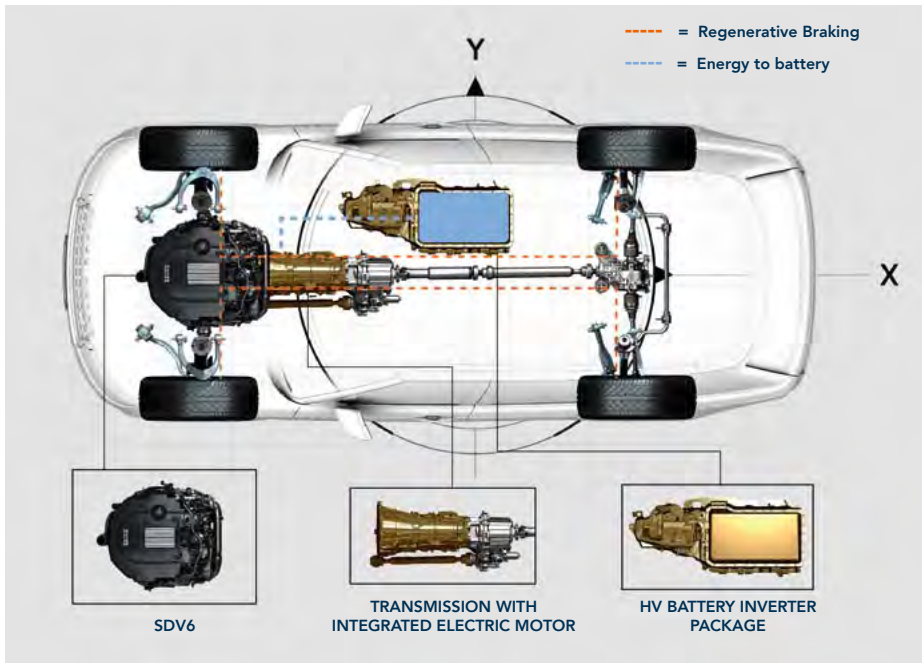

Innovative engineering ensures the transmission of energy between battery and engine is seamless. This energy is created by the Regenerative Braking process, which captures and stores kinetic energy in the battery, normally lost through braking. This is then used to power the electric motor and ensures that torque is instantly available on demand so the vehicle maintains unrivalled breadth of capability.

RANGE ROVER SPORT HYBRID



Select from four Hybrid driving modes to tailor the vehicle's performance to your requirements giving the most dynamic model in Land Rover's portfolio an extra dimension.



EV On Mode: Optimises hybrid battery power and is whisper quiet whilst travelling around town or peaceful villages.



EV Off Mode: Enables the vehicle's default setting where the hybrid system selects the most efficient combination of diesel and electric power to meet the power and torque required.



Sport Mode: Gives full access to the vehicle's comparable SDV8 performance. The throttle response becomes more immediate with torque triggered from less pedal pressure, ideal for overtaking when it is safe to do so.



Auto Stop/Start: Increases charging opportunities as this option means the engine runs continuously, inhibiting the Stop/Start system.

[Build & Price](#)

[Print](#)
[Save](#)
[Exit](#)



Attention to detail is at the very heart of Land Rover. That's why even the alloy wheels on all-new Range Rover Sport Hybrid have been designed for increased efficiency. The design features spokes that are aerodynamically shaped so, as they move through the air, they require less power to keep them moving.

To finish, the vehicle is specified with a unique Hybrid badge that is located on the side vent.

[Build & Price](#)

[Print](#)
[Save](#)
[Exit](#)

STEP 1 CHOOSE YOUR ENGINE



[Build & Price](#)

[Print](#)
[Save](#)
[Exit](#)

DRIVELINE, ENGINE PERFORMANCE AND FUEL ECONOMY

The improved range of petrol and diesel engines, along with the new hybrid engine, use the very latest powertrains. The 3.0 litre SDV6 diesel features Intelligent Stop/Start technology that automatically shuts down the engine at rest and starts again as soon as you lift your foot off the brake. In fact, coupled with lightweight all-aluminium technology and an eight-speed transmission, these engines deliver greatly improved fuel efficiency and lower CO₂ emissions. However, nothing has been lost in performance. For instance, the 5.0 litre V8 Supercharged goes from 0-60mph in just 5.0 seconds.

3.0L SDV6 DIESEL



3.0L SDV6 HYBRID DIESEL*



4.4L SDV8 DIESEL



5.0L V8 SUPERCHARGED PETROL



	3.0L SDV6 DIESEL	3.0L SDV6 HYBRID DIESEL	4.4L SDV8 DIESEL	5.0L V8 SUPERCHARGED PETROL
Driveline	Four Wheel Drive (4WD)	Four Wheel Drive (4WD)	Four Wheel Drive (4WD)	Four Wheel Drive (4WD)
Power (hp / kW)	292 / 215	340 / 250 [†]	339 / 250	510 / 375
Torque (Nm)	600	700 [†]	700	625
Maximum torque (rpm)	2,000	1,500 – 3,000 [†]	1,750 – 3,000	2,500 – 5,500
Capacity (cc)	2,993	2,993	4,367	4,999.7
No. of cylinders	6	6	8	8
Cylinder layout	Longitudinal V6	Longitudinal V6	Longitudinal V8	Longitudinal V8

FUEL ECONOMY

Urban	mpg	32.5	42.0	24.6	15.4
Extra Urban	mpg	41.5	45.0	37.2	29.1
Combined	mpg	37.7	44.1	32.5	22.1
CO ₂ Urban emissions	g/km	230	177	306	426
CO ₂ Extra Urban emissions	g/km	180	165	203	226
CO ₂ Combined emissions	g/km	199	169	229	298

*Please contact your local Land Rover Dealership regarding SDV6 Hybrid engine availability. [†]When combined with electric motor.

Fuel consumption figures: the results given here do not express or imply any guarantee of the fuel consumption of any particular vehicle with which this information may be supplied. Vehicles are not individually tested and there are inevitable differences between individual vehicles of the same model. The vehicle may also incorporate particular modifications. Furthermore, the driver's style and road traffic conditions, as well as the extent to which the vehicle has been driven and the standard of maintenance, will affect its fuel consumption. Low fuel warning at 9 litres approximately.

Visit landrover.co.uk for more information.

Build & Price

Print
Save
Exit

STEP 2 CHOOSE YOUR MODEL



[Build & Price](#)

[Print](#)
[Save](#)
[Exit](#)

MODELS BY ENGINE

	LIST PRICE	VAT 20.0%	RETAIL PRICE	ON-THE-ROAD PRICE
3.0 SDV6 DIESEL				
HSE	£49,554.17	£9,910.83	£59,465.00	£59,995.00
HSE Dynamic	£53,720.83	£10,744.17	£64,465.00	£64,995.00
Autobiography Dynamic	£62,054.17	£12,410.83	£74,465.00	£74,995.00
3.0 SDV6 HYBRID DIESEL				
Autobiography Dynamic	£67,675.00	£13,535.00	£81,210.00	£81,550.00
4.4 SDV8 DIESEL				
Autobiography Dynamic	£67,212.50	£13,442.50	£80,655.00	£81,550.00
5.0 V8 SUPERCHARGED PETROL				
Autobiography Dynamic	£67,025.00	£13,405.00	£80,430.00	£81,550.00

Visit landrover.co.uk for more information.

Build & Price

**Print
Save
Exit**

STEP 2 CHOOSE YOUR MODEL – CHOICES

Each model has a choice of engines and unique features. This guide will help you to select your ideal Range Rover Sport. On the following pages you'll see the standard features for each model.

RANGE ROVER SPORT HSE



- Grille in Atlas with Gloss Black surround
- Fender vent with Atlas fingers, Atlas mesh and Gloss Black surround
- Body-coloured upper mirror caps
- Seats in Oxford Perforated Leather as standard
- Paddle Shift
- 20 inch alloy wheels
- Fog lamp surrounds and tow eye covers in Atlas
- Premium metallic paint choice.

Above vehicles shown with 22 inch five split-spoke 'Style 6' alloy wheel.

[Build & Price](#)

[Print](#)
[Save](#)
[Exit](#)

RANGE ROVER SPORT HSE DYNAMIC



- Grille in Gloss Black painted mesh with Gloss Black surround
- Fender vent with Gloss Black fingers, Atlas mesh and Gloss Black surround
- Gloss Black upper mirror caps
- Tailgate finisher in Gloss Black
- Seats in Oxford Perforated Leather as standard
- Two exclusive colourways available for HSE Dynamic models: Ebony/Tan and Ebony/Pimento
- Paddle Shift
- Performance Enhancement
- Twin speed transfer box
- Dynamic Response™
- Torque Vectoring
- 21 inch alloy wheels
- Fog lamp surrounds and tow eye covers in Gloss Black
- Premium metallic paint choice.

Brembo is a registered trademark of Freni Brembo S.p.A

RANGE ROVER SPORT AUTOBIOGRAPHY DYNAMIC



- Grille in Gloss Black painted mesh with Gloss Black surround
- Fender vent with Gloss Black fingers, Atlas mesh and Gloss Black surround
- Gloss Black upper mirror caps
- Tailgate finisher in Gloss Black
- Seats in Oxford Perforated Leather with Autobiography Pattern as standard
- Autobiography colourways plus a further two: Ebony/Lunar/Cirrus and Ebony/Lunar/Savannah
- Meridian Surround Sound Audio System (825W) with 19 speakers
- Paddle Shift
- Performance Enhancement
- Twin speed transfer box
- Dynamic Response™ (not available for SDV6 Hybrid)
- Torque Vectoring
- 21 inch alloy wheels with Red brake calipers
- Fog lamp surrounds and tow eye covers in Gloss Black
- Premium metallic paint choice
- Sliding panoramic roof includes power blinds.

[Build & Price](#)

[Print](#)
[Save](#)
[Exit](#)

STEP 2 CHOOSE YOUR MODEL – STANDARD FEATURES

	HSE	HSE DYNAMIC	AUTOBIOGRAPHY DYNAMIC
ENGINE TRANSMISSION, SUSPENSION AND DRIVING DYNAMICS			
Eight-Speed Automatic Transmission with CommandShift® 2	■	■	■
Single Speed Transfer Box (high range only) (not available on SDV6 Hybrid, SDV8 and V8 Supercharged)	■		
Diesel Particulate Filter (diesel only)	■		■
Twin Speed Transfer Box (high/low range)		■	■
Electronic cross linked air suspension with automatic load levelling	■	■	■
Four Corner Air Suspension (FCAS)	■	■	■
Terrain Response® (1)	■		
Terrain Response® 2 Auto (2)		■	■
Adaptive Dynamics	■	■	■
Dynamic Response™ (2) (not available on SDV6 Hybrid)		■	■
Dynamic Program (2)		■	■
Torque Vectoring (2)		■	■
Intelligent Stop/Start System (not available on SDV8)	■	■	■
Speed proportional electric Power Assisted Steering (EPAS)	■	■	■
Paddle Shift (optional on SDV6 Hybrid)	■	■	■
Performance Enhancement (increase in top speed)		■	■
19 inch Black brake calipers			
20 inch Black brake calipers	■	■	■
20 inch Red Brembo™ branded brake calipers (front only, non-branded rear)			■
Electric Parking Brake (EPB)	■	■	■
Brake Pre-Fill (Non Radar)	■	■	■
Anti-lock Braking System (ABS)	■	■	■
Cornering Brake Control (CBC)	■	■	■
Dynamic Stability Control (DSC)	■	■	■
Electronic Brake-force Distribution (EBD)	■	■	■
Emergency Brake Assist (EBA)	■	■	■
Electronic Traction Control (ETC)	■	■	■
Gradient Acceleration Control (GAC)	■	■	■
Gradient Release Control (GRC)	■	■	■
Hill Descent Control (HDC®)	■	■	■
Reactive Grounding Response	■	■	■
Low Level Coolant Sensor	■	■	■
Shift By Wire (conventional automatic gearbox)	■	■	■
Fuel Flap - linked to central locking	■	■	■
Capless Filler	■	■	■

(1) Requires single speed transfer box (2) Requires twin speed transfer box.

Brembo is a registered trademark of Freni Brembo S.p.A

[Build & Price](#)

[Print](#)
[Save](#)
[Exit](#)

STEP 2 CHOOSE YOUR MODEL – STANDARD FEATURES

	HSE	HSE DYNAMIC	AUTOBIOGRAPHY DYNAMIC
EXTERIOR FEATURES AND FINISHERS			
Roof and Exterior Styling			
Body-coloured metal roof	■	■	
Sliding panoramic roof includes power blinds			■
Roof rack mounting provisions	■	■	■
Body-coloured upper mirror caps	■		
Gloss Black upper mirror caps		■	■
Twin tailpipes	■	■	■
Bright twin tailpipes		■	■
Painted side sills and bumpers (1)			■
Glass and Exterior Mirrors			
Acoustic laminated front windscreen	■	■	■
Laminated front door, toughened rear door and quarter light glass	■	■	■
Heated windscreen	■	■	■
Power windows (front and rear) with remote power locking	■	■	■
Rain sensing windscreen wipers	■	■	■
Heated off-screen wiper park position (manual lift away from screen)	■	■	■
Heated rear window	■	■	■
Exterior mirrors auto reverse dipping	■	■	■
Power adjustable, heated powerfold exterior mirrors with approach lamps (2)	■	■	■
Headlamps and Lighting			
Front fog lamps	■	■	■
Rear fog lamps	■	■	■
Automatic headlamps	■	■	■
Xenon headlamps with LED signature (includes headlamp power wash)	■	■	■
Daytime Running Lights (DRL's)	■	■	■
Follow-me-home lighting	■	■	■
LED rear lamps	■	■	■
Side repeater indicators in mirror	■	■	■
Hazard lights under heavy braking	■	■	■
Left to right hand drive easy configurable headlamps	■	■	■
Automatic High Beam Assist (AHBA)			■
Paint			
Solid Paint	■	■	■
Metallic Paint	■	■	■
Premium Metallic Paint	■	■	■
Towing			
Trailer stability control	■	■	■
3,500kg gross towing load (3)	■	■	■
Electrical towing preparation	■	■	■
Front and rear recovery hooks	■	■	■

(1) Features on Autobiography Dynamic only when contrast roof is present (2) Includes memory function when memory seats feature (3) 3,000kg for SDV6 Hybrid

STEP 2 CHOOSE YOUR MODEL – STANDARD FEATURES

	HSE	HSE DYNAMIC	AUTOBIOGRAPHY DYNAMIC
EXTERIOR FEATURES AND FINISHERS (CONTINUED)			
Wheels and Wheel Options			
19 inch five split-spoke 'Style 1'			
20 inch five split-spoke 'Style 12'	■		
21 inch six-spoke 'Style 11' (SDV6 Hybrid only)			■
21 inch five split-spoke – Diamond Turned Finish 'Style 15'		■	
21 inch five split-spoke 'Style 16' (not standard for SDV6 Hybrid)			■
Locking wheel nuts	■	■	■
Tyre pressure monitoring system	■	■	■
Reduced section spare wheel (1)	■	■	■
SEATING, INTERIOR FEATURES AND FINISHERS			
Seating			
Grained Leather			
Oxford Perforated Leather	■	■	
Oxford Perforated Leather with Autobiography Pattern (Single / Duo / Tri tone)			■
'Style 1' – six-way / four-way semi-powered seats			
'Style 3' – 14-way / 14-way powered seats with memory	■	■	
'Style 5' – 18-way / 18-way powered seats with memory			■
60:40 Folding rear seats	■	■	■
Head restraints with two-way adjust	■	■	■
Heated front seats			
Heated front and rear seats	■	■	
Climate front seats with heated rear seats			■
ISOFIX seat anchorages	■	■	■
Second row manual recline	■	■	■
Steering Wheel			
Manual steering column			
Power adjustable steering column (entry and exit tilt away with reach / rake on steering wheel)	■	■	■
Leather steering wheel with multi-functional controls	■	■	
Heated leather steering wheel with multi-functional controls			■
Interior Finisher			
Dark Brushed Aluminium trim finisher			
Micro Mesh Aluminium trim finisher	■		
Sport Textured Aluminium trim finisher		■	
Dark Engine Turned Aluminium trim finisher			■
Headlining			
Morzine headlining (Cirrus or Ivory dependent on colourway)	■	■	
Alston headlining (Cirrus, Ivory or Ebony dependent on colourway)			■

(1) Not available with 5+2 seating

[Build & Price](#)

[Print](#)
[Save](#)
[Exit](#)

STEP 2 CHOOSE YOUR MODEL – STANDARD FEATURES

	HSE	HSE DYNAMIC	AUTOBIOGRAPHY DYNAMIC
SEATING, INTERIOR FEATURES AND FINISHERS (CONTINUED)			
Interior Features			
Stainless steel sports pedals		■	■
Aluminium treadplates with Range Rover lettering	■		
Illuminated aluminium treadplates with Range Rover lettering		■	■
Single blade sunvisor	■	■	■
Auto dimming interior mirror	■	■	■
Front centre console cooler compartment			■
Two-zone climate control	■	■	
Three-zone climate control			■
Interior mood lighting	■	■	
Customer configurable interior mood lighting			■
Driver and passenger sunvisor with illuminated vanity mirror	■	■	■
Centre armrest with cubby box	■	■	■
Front and rear grab handles	■	■	■
Front and rear cupholders	■	■	■
Secure glove box stowage	■	■	■
Front and rear carpet mats	■	■	
Front and rear premium carpet mats			■
Non smokers pack (stowage bin)	■	■	■
Pedal footrest	■	■	■
Mist sensing, auto demisting, air filter and pollen purifier	■	■	■
Smog sensing / auto recirculation	■	■	■
Climate control memory pre-set to driver's last temperature	■	■	■
SAFETY AND SECURITY			
Remote power central locking	■	■	■
Single point entry, customer configurable	■	■	■
Remote power window locking	■	■	■
Autolock (doors on drive away)	■	■	■
Power operated child locks	■	■	■
Push button keyless Start/Stop	■	■	■
Driver and passenger airbags (side, seat-front, thorax, pelvis)	■	■	■
Roll Stability Control (RSC)	■	■	■
Active Speed Limiter device (ASL)	■	■	■
Front height adjustable seat belts	■	■	■
Volumetric and Perimetric Alarm (includes tilt sensor and battery) backed soundert and all perimetric features	■	■	■

The Bluetooth® word mark and logos are owned by the Bluetooth SIG, Inc. and any use of such marks by Land Rover is under licence.

[Build & Price](#)

[Print](#)
[Save](#)
[Exit](#)

STEP 2 CHOOSE YOUR MODEL – STANDARD FEATURES

	HSE	HSE DYNAMIC	AUTOBIOGRAPHY DYNAMIC
CONVENIENCE AND LOADSPACE FEATURES			
Vehicle Aids			
Front parking aid with front visual display	■	■	■
Rear park distance sensors with visual display	■	■	■
Cruise control	■	■	■
Adaptive Cruise Control (ACC) with Queue Assist, Intelligent Braking and Active Seat Belts (1)			■
Rear view camera	■	■	■
Keyless entry	■	■	■
Loadspace Features			
Roller loadspace cover	■	■	■
Loadspace mounting provisions	■	■	■
Power single piece tailgate	■	■	■
Handbag hook / curry hook in loadspace	■	■	■
Load compartment light	■	■	■
Secure glovebox stowage	■	■	■
INFORMATION, COMMUNICATION AND ENTERTAINMENT			
Range Rover Audio System (380W) with eight speakers	■	■	
Meridian™ Surround Sound Audio System (825W) with 19 speakers			■
Eight-inch Touch-screen	■	■	■
User selectable screen savers	■	■	■
TFT virtual instrument panel	■	■	■
Hard disk navigation system	■	■	■
MP3 compatible audio hard disk server	■	■	■
Two USB Sockets (front and second row)	■	■	■
Auxiliary device connectivity (full integrated streaming)	■	■	■
Bluetooth® audio streaming	■	■	■
Bluetooth® phone connection	■	■	■
Auxiliary power sockets (front, second row and loadspace 12V)	■	■	■
Event data recorder	■	■	■
Digital Radio (DAB)	■	■	■
'Say What You See' intuitive voice control (SWYS)	■	■	■

(1) SDV6 Hybrid does not feature Queue Assist

[Build & Price](#)

[Print](#)
[Save](#)
[Exit](#)

STEP 3 CHOOSE YOUR COLOUR

Body and Roof Colour

Fuji White (Solid)	Aleutian Silver (Metallic)	Indus Silver (Metallic)	Ipanema Sand (Metallic)	Luxor (Premium Metallic)	Chablis* (Metallic)	Scotia Grey (Metallic)	Nara Bronze (Metallic)	Corris Grey (Metallic)	Causeway Grey (Premium Metallic)

Optional Roof Colour

Contrast Indus Silver

not available	not available	not available	not available	not available	not available				
---------------	---------------	---------------	---------------	---------------	---------------	--	--	--	--

Contrast Corris Grey

						not available	not available	not available	not available
--	--	--	--	--	--	---------------	---------------	---------------	---------------

Contrast Santorini Black

--	--	--	--	--	--	--	--	--	--

*Available early 2014

STEP 3 CHOOSE YOUR COLOUR

Body and Roof Colour

Firenze Red
(Metallic)

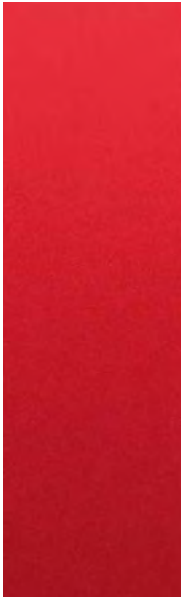

Chile
(Premium Metallic)

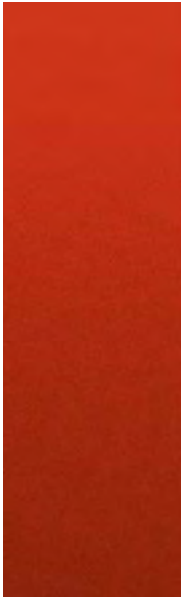

Aintree Green
(Metallic)



Loire Blue
(Metallic)



Mariana Black
(Premium Metallic)

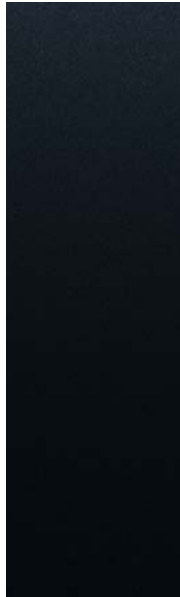

Santorini Black
(Metallic)

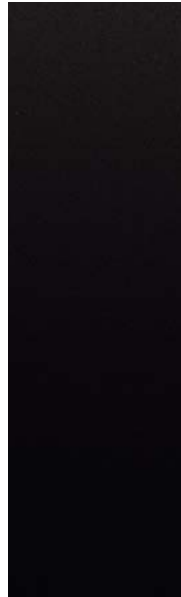

Barossa
(Premium Metallic)



Havana
(Premium Metallic)



Barolo Black
(Premium Metallic)



Optional Roof Colour

Contrast Indus Silver

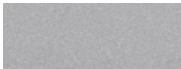
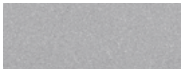

Contrast Corris Grey

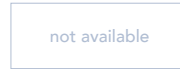

Contrast Santorini Black

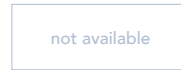
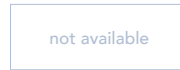
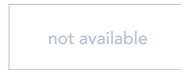
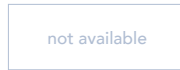
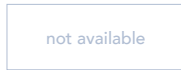

Visit landrover.co.uk for more information.

Build & Price

Print
Save
Exit

STEP 4 CHOOSE YOUR WHEELS



19 INCH FIVE SPLIT-SPOKE
'STYLE 1'*



20 INCH FIVE SPLIT-SPOKE
'STYLE 12'*



21 INCH SIX-SPOKE
'STYLE 10'**



21 INCH SIX-SPOKE DIAMOND TURNED FINISH
'STYLE 11'**



21 INCH FIVE SPLIT-SPOKE
'STYLE 14'*



21 INCH FIVE SPLIT-SPOKE
'STYLE 15'*

Visit landrover.co.uk for more information.

Build & Price

**Print
Save
Exit**

STEP 4 CHOOSE YOUR WHEELS



21 INCH FIVE SPLIT-SPOKE
'STYLE 16'



22 INCH FIVE SPLIT-SPOKE
'STYLE 6'



22 INCH FIVE SPLIT-SPOKE
'STYLE 17'

	OPTION CODE	HSE	HSE DYNAMIC	AUTOBIOGRAPHY DYNAMIC
WHEELS				
19 inch five split-spoke 'Style 1'	029SA	-	-	-
20 inch five split-spoke 'Style 12'	029SB	■	△	△
21 inch six-spoke 'Style 10'	029TA	-	-	△**
21 inch six-spoke Diamond Turned Finish 'Style 11'	029TB	-	-	■***
21 inch five split-spoke 'Style 14'*	029SD	□	△	△
21 inch five split-spoke Diamond Turned Finish 'Style 15**	029SE	□	■	□***
21 inch five split-spoke 'Style 16'	029SW	-	-	■***
22 inch five split-spoke 'Style 6'	029SF	□	□	□
22 inch five split-spoke 'Style 17'	029SY	-	-	□

Please note: 19 inch and 22 inch wheels are not available with 5+2 seating options.

*Available as an accessory fitment **SDV6 Hybrid only ***No cost option for SDV6 Hybrid.

■ Standard □ Optional △ No Cost Option - Not Available

Build & Price

Print
Save
Exit

STEP 5 CHOOSE YOUR INTERIOR



Visit landrover.co.uk for more information.

[Build & Price](#)

[Print](#)
[Save](#)
[Exit](#)

STEP 5 CHOOSE YOUR INTERIOR



Contemporary. Beautifully designed. Flawlessly executed. The interior of each and every all-new Range Rover Sport defines modern living. The strong architectural lines of the interior are balanced by soft lighting and the choice of colourways available. The fit and finish has been taken to another level: the use of leather and metal truly complements the sporty styling.

[Build & Price](#)

[Print](#)
[Save](#)
[Exit](#)

STEP 5 CHOOSE YOUR INTERIOR – LEATHER FINISHES



The softest of leathers, the most meticulous of finishes

The interior is upholstered in the finest natural materials. The warmth of wood veneers, superb metal finishes and soft leathers combine to create a sense of home. The attention to detail is everywhere you look and in everything you touch. The type of leather is determined by model choice as outlined in the following pages.

[Build & Price](#)

[Print](#)
[Save](#)
[Exit](#)

STEP 5 CHOOSE YOUR INTERIOR – TRIM FINISHER CHOICES



MICRO MESH
ALUMINIUM FINISHER
(HSE)

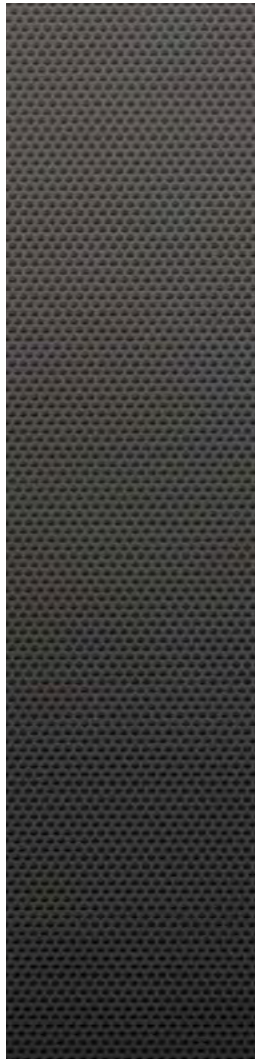

SPORT TEXTURED
ALUMINIUM FINISHER
(HSE DYNAMIC)

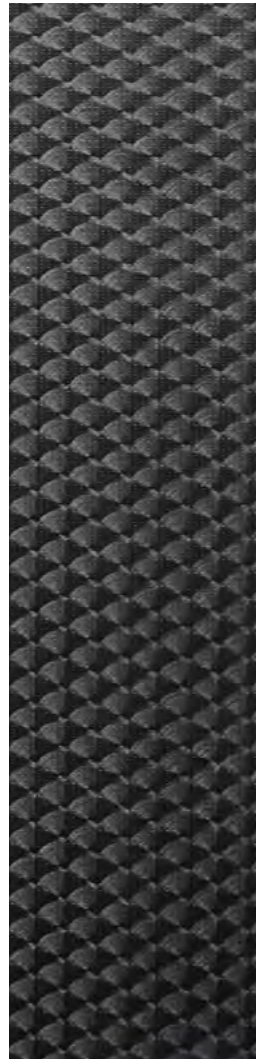

DARK ENGINE TURNED
ALUMINIUM FINISHER
(AUTOBIOGRAPHY DYNAMIC)



SHADOW ZEBRANO
WOOD VENEER
(OPTIONAL)



DARK GREY OAK
WOOD VENEER
(OPTIONAL)



GRAND BLACK
WOOD VENEER
(OPTIONAL)

[Build & Price](#)

[Print](#)
[Save](#)
[Exit](#)

STEP 5 CHOOSE YOUR INTERIOR – INTERIOR SEAT OPTIONS



5 Seats

The seat configuration has been intelligently redesigned to accommodate the lines of the roofline. It's light and spacious, ensuring everyone has a relaxed and comfortable journey. There is generous leg, shoulder and head room throughout the contemporary cabin.

Image shown with optional 60:40 rear seat with 'load through'

[Build & Price](#)

[Print](#)
[Save](#)
[Exit](#)

STEP 5 CHOOSE YOUR INTERIOR – INTERIOR SEAT OPTIONS



























5+2 Seating

5+2 Seating has two seats stowed under the floor of the luggage compartment that have been designed specifically for children or occasional use. The second row of seats tip and slide forward to provide access to the third row and have 100mm fore/aft movement to allow flexibility of space. The additional seats are raised and lowered electronically with controls mounted on each side of the cabin and in the boot.

[Build & Price](#)

























[Print](#)
[Save](#)
[Exit](#)

COLOUR AND TRIM MATRIX

COLOURWAYS		EBONY/LUNAR			ESPRESSO/ALMOND			EBONY/CIRRUS			ESPRESSO/IVORY		
INTERIOR COLOUR													
Seat Colour	Ebony	Lunar	Ebony/Lunar	Espresso	Almond	Espresso/ Almond	Ebony	Cirrus	Ebony/Cirrus	Espresso	Ivory	Espresso/Ivory	
Carpet	Ebony			Espresso			Ebony			Espresso			
Ebony Headliner	TMB	TML	TNF	-	-	-	TMD	TMH	TND	-	-	-	
Ivory Headliner	-	-	-	TMT	TMJ	TMZ	-	-	-	TMS	TMR	TMW	
Cirrus Headliner	TMA	TMK	TNE	-	-	-	TMC	TMG	TNC	-	-	-	
MODEL													
HSE (Oxford Perforated Leather)	o	o	-	o	o	-	o	o	-	o	o	-	
HSE Dynamic (Oxford Perforated Leather)	o	o	-	o	o	-	o	o	-	o	o	-	
Autobiography Dynamic (Oxford Perforated Leather with Autobiography Pattern)	o	o	o	o	o	o	o	o	o	o	o	o	
TRIM FINISHER													
 Micro Mesh Aluminium Finisher	o	-	-	o	o	-	o	o	-	o	o	-	
 Sport Textured Aluminium Finisher	o	o	-	o	o	-	o	o	-	o	o	-	
 Dark Engine Turned Aluminium Finisher	o	o	o	o	o	o	o	o	o	o	o	o	
 Shadow Zebrano Wood Veneer	-	-	-	o	o	o	-	-	-	o	o	o	
 Dark Grey Oak Wood Veneer	o	o	o	-	-	-	o	o	o	-	-	-	
 Grand Black Wood Veneer	o	o	o	o	o	o	o	o	o	o	o	o	
EXTERIOR COLOUR													
 Fuji White	o	o	o	o	o	o	o	o	▲	o	o	o	
 Aleutian Silver	o	o	o	o	o	o	o	▲	o	o	o	o	
 Indus Silver	▲	o	o	o	o	o	▲	o	o	o	o	o	
 Ipanema Sand	o	o	o	o	o	o	o	o	o	o	▲	o	
 Luxor	o	o	o	▲	o	o	o	o	o	▲	o	o	
 Chablis*	o	o	o	o	o	o	o	o	o	o	o	o	
 Scotia Grey	o	o	o	o	o	o	o	o	o	o	o	o	
 Nara Bronze	o	o	o	▲	▲	o	o	o	o	▲	o	o	
 Corris Grey	o	o	▲	o	o	o	o	o	o	o	o	o	
 Causeway Grey	o	o	▲	o	o	o	▲	o	▲	o	o	o	
 Firenze Red	o	o	o	o	o	o	o	o	o	o	o	o	
 Chile	▲	o	o	o	o	o	o	o	o	o	o	o	
 Aintree Green	o	o	o	o	o	o	o	o	o	o	▲	o	
 Loire Blue	o	o	o	o	o	o	o	o	o	o	o	o	
 Mariana Black	o	o	o	o	o	o	o	▲	o	o	o	o	
 Santorini Black	o	▲	o	o	o	o	o	▲	o	o	o	o	
 Barossa	o	o	o	o	▲	o	o	o	o	o	o	o	
 Havana	o	▲	o	o	o	▲	o	o	o	o	o	▲	
 Barolo Black	o	o	o	o	o	o	o	o	o	o	▲	o	

The above table is designed as a guide. The three letters represent the trim codes to aid in the ordering process. Please contact your nearest Land Rover Dealership for more information. *Available early 2014.

COLOUR AND TRIM MATRIX

COLOURWAYS		EBONY/IVORY			EBONY/TAN		EBONY/PIMENTO		ESPRESSO/ IVORY/TAN	ESPRESSO/IVORY/ SAVANNAH	EBONY/LUNAR/ CIRRUS	EBONY/LUNAR/ SAVANNAH
INTERIOR COLOUR												
Seat Colour	Ebony	Ivory	Ebony/Ivory	Tan	Ebony/Tan	Pimento	Ebony/Pimento	Espresso/Ivory/Tan	Espresso/Ivory/ Savannah	Ebony/Lunar/Cirrus	Ebony/Lunar/Savannah	
Carpet	Ebony			Ebony		Ebony		Espresso	Espresso	Ebony	Ebony	
Ebony Headliner	TMF	TMQ	TMY	TMN	TNH	TMV	TNK	–	–	TNM	TNP	
Ivory Headliner	TME	TMP	TMX	TMM	TNG	–	–	TNB	TNA	–	–	
Cirrus Headliner	–	–	–	–	–	TMU	TNJ	–	–	TNL	TNN	
MODEL												
HSE (Oxford Perforated Leather)	o	o	–	–	–	–	–	–	–	–	–	
HSE Dynamic (Oxford Perforated Leather)	o	o	–	o	–	o	–	–	–	–	–	
Autobiography Dynamic (Oxford Perforated Leather with Autobiography Pattern)	o	o	o	o	o	o	o	o	o	o	o	
TRIM FINISHER												
 Micro Mesh Aluminium Finisher	o	o	–	–	–	–	–	–	–	–	–	
 Sport Textured Aluminium Finisher	o	o	–	o	–	o	–	–	–	–	–	
 Dark Engine Turned Aluminium Finisher	o	o	o	o	o	o	o	o	o	o	o	
 Shadow Zebrano Wood Veneer	o	o	o	–	–	–	–	o	o	–	–	
 Dark Grey Oak Wood Veneer	–	–	–	o	o	o	o	–	–	o	o	
 Grand Black Wood Veneer	o	o	o	o	o	o	o	o	o	o	o	
EXTERIOR COLOUR												
 Fuji White	o	o	o	▲	o	o	o	o	o	▲	o	
 Aleutian Silver	o	o	o	o	o	o	o	o	o	▲	o	
 Indus Silver	o	o	o	o	o	o	o	o	o	o	o	
 Ipanema Sand	o	o	o	o	o	o	o	o	o	o	o	
 Luxor	o	o	o	o	o	o	o	▲	o	o	o	
 Chablis*	o	o	o	o	o	o	o	o	▲	o	▲	
 Scotia Grey	o	o	o	o	o	o	o	o	o	o	o	
 Nara Bronze	o	o	o	o	o	o	o	▲	o	o	o	
 Corris Grey	o	o	o	▲	o	o	▲	o	o	▲	▲	
 Causeway Grey	o	o	▲	o	▲	▲	o	o	o	▲	▲	
 Firenze Red	▲	o	o	–	–	o	▲	o	–	o	–	
 Chile	o	o	o	o	o	o	o	o	–	o	–	
 Aintree Green	o	o	o	o	o	o	o	o	o	o	o	
 Loire Blue	o	▲	o	o	o	o	o	o	o	o	o	
 Mariana Black	o	▲	o	o	o	o	o	o	o	o	o	
 Santorini Black	o	▲	▲	o	▲	▲	o	o	o	o	▲	
 Barossa	o	o	o	o	o	o	o	–	–	–	–	
 Havana	▲	o	o	▲	o	o	o	o	▲	o	o	
 Barolo Black	o	o	o	o	o	o	▲	o	o	o	o	

The above table is designed as a guide. The three letters represent the trim codes to aid in the ordering process. Please contact your nearest Land Rover Dealership for more information. *Available early 2014.

STEP 5 CHOOSE YOUR INTERIOR – CHOICES

Colour choices

Each interior comes in up to three colour combinations. You can now use this section to place your chosen colourway within the vehicle to personalise your cabin. A choice of trim finishers are also available.



COLOURWAYS	① INSTRUMENT PANEL UPPER	② INSTRUMENT PANEL MID-SECTION	③ DOOR TOP ROLL	④ DOOR ARMREST	⑤ DOOR LOWER
Ebony/Lunar	Ebony	Lunar	Lunar	Lunar	Ebony
Espresso/Almond	Espresso	Almond	Almond	Almond	Almond
Ebony/Cirrus	Ebony	Cirrus	Cirrus	Cirrus	Ebony
Espresso/Ivory	Espresso	Ivory	Ivory	Ivory	Ivory
Ebony/Ivory	Ebony	Ivory	Ivory	Ivory	Ebony
Ebony/Tan	Ebony	Tan	Tan	Tan	Ebony
Ebony/Pimento	Ebony	Pimento	Pimento	Pimento	Ebony
Espresso/Ivory/Tan	Espresso	Ivory	Ivory	Tan	Ivory
Espresso/Ivory/Savannah	Espresso	Ivory	Ivory	Savannah	Ivory
Ebony/Lunar/Cirrus	Ebony	Lunar	Lunar	Cirrus	Ebony
Ebony/Lunar/Savannah	Ebony	Lunar	Lunar	Savannah	Ebony

[Build & Price](#)

[Print](#)
[Save](#)
[Exit](#)

STEP 5 CHOOSE YOUR INTERIOR – CHOICES

Ebony / Lunar (available on HSE, HSE Dynamic, Autobiography Dynamic)



Interior Shown:

Autobiography Dynamic interior in Ebony/Lunar, with Ebony/Lunar seats and Dark Engine Turned/Aluminium Finisher.

Seat Choices



Ebony ■◆



Lunar ■◆



Ebony/Lunar ◆

Trim Finisher Choices



Dark Engine Turned Aluminium Finisher ◆



Micro Mesh Aluminium Finisher ■



Sport Textured Aluminium Finisher ●



Grand Black Wood Veneer ■◆◆



Dark Grey Oak Wood Veneer ■◆◆

This interior is available in: Oxford leather on HSE models Oxford leather with Autobiography Pattern on Autobiography models.

For specific colourway options please refer to the **Colour & Trim Matrix**. For specific combinations of veneers and headlining for your model please refer to **Optional Features**.

- HSE
- HSE Dynamic
- ◆ Autobiography Dynamic

[Build & Price](#)

[Print](#)
[Save](#)
[Exit](#)

STEP 5 CHOOSE YOUR INTERIOR – CHOICES

Espresso / Almond (available on HSE, HSE Dynamic, Autobiography Dynamic)



Interior shown:
Autobiography Dynamic interior in Espresso/Almond, with Espresso/Almond seats and Shadow Zebrano Wood Veneer.

Seat Choices



Espresso ■◆



Almond ■◆



Espresso/Almond◆

Trim Finisher Choices



Dark Engine Turned Aluminium Finisher◆



Micro Mesh Aluminium Finisher■



Sport Textured Aluminium Finisher●



Grand Black Wood Veneer ■◆◆



Shadow Zebrano Wood Veneer ■◆◆

This interior is available in:
Oxford leather on HSE models
Oxford leather with Autobiography Pattern on Autobiography models.

For specific colourway options please refer to the **Colour & Trim Matrix**. For specific combinations of veneers and headlining for your model please refer to **Optional Features**.

- HSE
- HSE Dynamic
- ◆ Autobiography Dynamic

[Build & Price](#)

[Print](#)
[Save](#)
[Exit](#)

STEP 5 CHOOSE YOUR INTERIOR – CHOICES

Ebony / Cirrus (available on HSE, HSE Dynamic, Autobiography Dynamic)



Interior shown:
HSE interior in Ebony/Cirrus,
with Ebony seats and
Grand Black Wood Veneer.

Seat Choices



Ebony ■◆

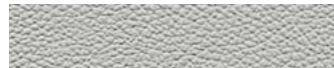

Cirrus ■◆

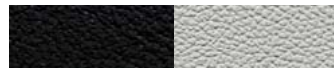

Ebony/Cirrus ◆

Trim Finisher Choices



Dark Engine Turned Aluminium Finisher ◆



Micro Mesh Aluminium Finisher ■



Sport Textured Aluminium Finisher ●



Grand Black Wood Veneer ■◆



Dark Grey Oak Wood Veneer ■◆

This interior is available in:
Oxford leather on HSE models
Oxford leather with Autobiography Pattern
on Autobiography models.

For specific colourway options please refer to the
Colour & Trim Matrix. For specific combinations
of veneers and headlining for your model please
refer to **Optional Features**.

■ HSE
● HSE Dynamic
◆ Autobiography Dynamic

[Build & Price](#)

[Print](#)
[Save](#)
[Exit](#)

STEP 5 CHOOSE YOUR INTERIOR – CHOICES

Espresso / Ivory (available on HSE, HSE Dynamic, Autobiography Dynamic)



Interior shown:
Autobiography Dynamic interior
in Espresso/Ivory, with Espresso/
Ivory seats and Micro Mesh
Aluminium Finisher.

Seat Choices



Espresso ■◆◆



Ivory ■◆◆



Espresso/Ivory ◆

Trim Finisher Choices



Micro Mesh Aluminium Finisher ■



Sport Textured Aluminium Finisher ●



Dark Engine Turned Aluminium Finisher ◆



Grand Black Wood Veneer ■◆◆



Shadow Zebrano Wood Veneer ■◆◆

This interior is available in:
Oxford leather on HSE models
Oxford leather with Autobiography Pattern
on Autobiography models.

For specific colourway options please refer to the
Colour & Trim Matrix. For specific combinations
of veneers and headlining for your model please
refer to **Optional Features**.

■ HSE
● HSE Dynamic
◆ Autobiography Dynamic

[Build & Price](#)

[Print](#)
[Save](#)
[Exit](#)

STEP 5 CHOOSE YOUR INTERIOR – CHOICES

Ebony / Ivory (HSE, HSE Dynamic, Autobiography Dynamic)



Interior shown:
Autobiography Dynamic interior in
Ebony/Ivory, with Ebony/Ivory
seats and Micro Mesh
Aluminium Finisher.

Seat Choices



Ebony ■◆



Ivory ■◆



Ebony/Ivory ◆

Trim Finisher Choices



Micro Mesh Aluminium Finisher ■



Sport Textured Aluminium Finisher ●



Dark Engine Turned Aluminium Finisher ◆



Grand Black Wood Veneer ■◆



Shadow Zebrano Wood Veneer ■◆

This interior is available in:
Oxford leather on HSE models
Oxford leather with Autobiography Pattern
on Autobiography models.

For specific colourway options please refer to the
Colour & Trim Matrix. For specific combinations
of veneers and headlining for your model please
refer to **Optional Features**.

■ HSE
● HSE Dynamic
◆ Autobiography Dynamic

Build & Price

**Print
Save
Exit**

STEP 5 CHOOSE YOUR INTERIOR – CHOICES

Ebony / Tan (available on HSE Dynamic and Autobiography Dynamic only)



Interior shown:
Autobiography Dynamic interior in
Ebony/Tan, with Ebony/Tan seats
and Dark Grey Oak Wood Veneer.

- HSE
- HSE Dynamic
- ◆ Autobiography Dynamic

Seat Choices



Tan ◆◆



Ebony/Tan ◆

Trim Finisher Choices



Sport Textured Aluminium Finisher ●



Dark Engine Turned Aluminium Finisher ◆



Dark Grey Oak Wood Veneer ◆◆



Grand Black Wood Veneer ◆◆

This interior is available in:
Oxford leather on HSE models
Oxford leather with Autobiography Pattern
on Autobiography models.

For specific colourway options please refer to the
Colour & Trim Matrix. For specific combinations
of veneers and headlining for your model please
refer to **Optional Features**.

Build & Price

**Print
Save
Exit**

STEP 5 CHOOSE YOUR INTERIOR – CHOICES

Ebony / Pimento (available on HSE Dynamic and Autobiography Dynamic only)



Interior shown:
Autobiography Dynamic interior in
Ebony/Pimento, with Ebony/Pimento
seats and Dark Engine Turned
Aluminium Finisher.

- HSE
- HSE Dynamic
- ◆ Autobiography Dynamic

Seat Choices



Pimento ◆◆



Ebony/Pimento ◆

Trim Finisher Choices



Sport Textured Aluminium Finisher ●



Dark Engine Turned Aluminium Finisher ◆



Dark Grey Oak Wood Veneer ◆◆



Grand Black Wood Veneer ◆◆

This interior is available in:
Oxford leather on HSE models
Oxford leather with Autobiography pattern
on Autobiography models.

For specific colourway options please refer to the
Colour & Trim Matrix. For specific combinations
of veneers and headlining for your model please
refer to **Optional Features**.

Build & Price

Print
Save
Exit

STEP 5 CHOOSE YOUR INTERIOR – CHOICES

Espresso / Ivory / Tan (available on Autobiography Dynamic only)



Interior shown:
Autobiography Dynamic interior in
Espresso/Ivory/Tan, with Espresso/
Ivory/Tan seats and Shadow
Zebrano Wood Veneer.

Seat Choices



Espresso/Ivory/Tan

Trim Finisher Choices



Dark Engine Turned Aluminium Finisher



Shadow Zebrano Wood Veneer



Grand Black Wood Veneer

This interior is available in:
Oxford leather with Autobiography Pattern
on Autobiography models.

For specific colourway options please refer to the
Colour & Trim Matrix. For specific combinations
of veneers and headlining for your model please
refer to **Optional Features**.

Build & Price

Print
Save
Exit

STEP 5 CHOOSE YOUR INTERIOR – CHOICES

Espresso / Ivory / Savannah (available on Autobiography Dynamic only)



Interior shown:
Autobiography Dynamic interior in
Espresso/Ivory/Savannah,
with Espresso/Ivory/Savannah
seats and Micro Mesh
Aluminium Finisher.

Seat Choices



Espresso/Ivory/Savannah

Trim Finisher Choices



Dark Engine Turned Aluminium Finisher



Shadow Zebrano Wood Veneer



Grand Black Wood Veneer

This interior is available in:
Oxford leather with Autobiography Pattern
on Autobiography models.

For specific colourway options please refer to the
Colour & Trim Matrix. For specific combinations
of veneers and headlining for your model please
refer to **Optional Features**.

[Build & Price](#)

[Print](#)
[Save](#)
[Exit](#)

STEP 5 CHOOSE YOUR INTERIOR – CHOICES

Ebony / Lunar / Cirrus (available on Autobiography Dynamic only)



Interior shown:
Autobiography Dynamic interior in
Ebony/Lunar/Cirrus, with Ebony/
Lunar/Cirrus seats and Dark Grey
Oak Wood Veneer.

Seat Choices



Ebony/Lunar/Cirrus

Trim Finisher Choices



Dark Engine Turned Aluminium Finisher



Dark Grey Oak Wood Veneer



Grand Black Wood Veneer

This interior is available in:
Oxford leather with Autobiography Pattern
on Autobiography models.

For specific colourway options please refer to the
Colour & Trim Matrix. For specific combinations
of veneers and headlining for your model please
refer to **Optional Features**.

[Build & Price](#)

[Print](#)
[Save](#)
[Exit](#)

STEP 5 CHOOSE YOUR INTERIOR – CHOICES

Ebony / Lunar / Savannah (available on Autobiography Dynamic only)

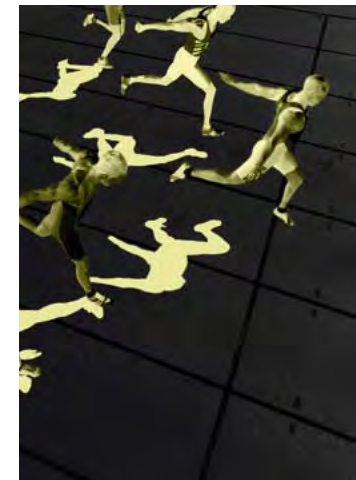

Interior shown:
Autobiography Dynamic interior
in Ebony/Lunar/Savannah, with
Ebony/Lunar/Savannah seats
and Dark Grey Oak Wood Veneer.

Seat Choices



Ebony/Lunar/Savannah

Trim Finisher Choices



Dark Engine Turned Aluminium Finisher



Dark Grey Oak Wood Veneer



Grand Black Wood Veneer

This interior is available in:
Oxford leather with Autobiography Pattern
on Autobiography models.

For specific colourway options please refer to the
Colour & Trim Matrix. For specific combinations
of veneers and headlining for your model please
refer to **Optional Features**.

[Build & Price](#)

[Print](#)
[Save](#)
[Exit](#)

STEP 6 CHOOSE YOUR OPTIONS

Engine Transmission, Suspension and Driving Dynamics

	OPTION CODE	HSE	HSE DYNAMIC	AUTOBIOGRAPHY DYNAMIC	LIST PRICE	VAT	RETAIL PRICE
Paddle Shift	078CB	■	■	■ (1)	£166.67	£33.33	£200.00
Noble Plated Paddle Shift	078CC	–	–	□ (2)	£208.33	£41.67	£250.00
Off-road pack – includes twin speed transfer box and Terrain Response® 2 Auto (4)	074QA	□	–	–	£341.67	£68.33	£410.00
On / Off-Road Pack – includes twin speed transfer box, Terrain Response® 2 Auto (including Dynamic program), Dynamic Response™ and Torque Vectoring	074QC	□	–	–	£2,808.33	£561.67	£3,370.00
20 inch Red Brembo™ branded brake calipers	020BE	□	□	■	£275.00	£55.00	£330.00

Exterior Features and Finishers

	OPTION CODE	HSE	HSE DYNAMIC	AUTOBIOGRAPHY DYNAMIC	LIST PRICE	VAT	RETAIL PRICE
ROOF AND EXTERIOR STYLING							
Sliding panoramic roof includes power blinds	041CZ	□	□	■	£1,250.00	£250.00	£1,500.00
Contrast roof – Corris Grey (5)	080EE	□	□	Δ	£416.67	£83.33	£500.00
Contrast roof – Indus Silver (5)	080AD	□	□	Δ	£416.67	£83.33	£500.00
Contrast roof – Santorini Black (5)	080AN	□	□	Δ	£416.67	£83.33	£500.00
GLASS AND EXTERIOR MIRRORS							
Solar attenuating windscreen (not available with privacy glass)	047AH	□	□	□	£375.00	£75.00	£450.00
Privacy glass	047AB	□	□	□	£250.00	£50.00	£300.00
Privacy glass with solar attenuating windscreen	047AV	□	□	□	£625.00	£125.00	£750.00
Power adjustable, heated powerfold exterior mirrors with approach lamps and auto dimming (6)	031EB	□	□	□	£154.17	£30.83	£185.00
HEADLAMPS AND LIGHTING							
Adaptive xenon headlamps with LED signature (includes headlamp powerwash)	064DI	□	□	□	£250.00	£50.00	£300.00
Automatic headlamps with High Beam Assist (AHBA) (requires xenon or adaptive xenon headlamps)	030NT	□	□	■	£125.00	£25.00	£150.00
TOWING							
Electrically deployed tow bar	028EJ	□	□	□	£791.67	£158.33	£950.00

(1) Optional for SDV6 Hybrid (2) SDV6 Hybrid only (3) SDV6, SDV8 and 5.0 Supercharged (4) For Dynamic program, Dynamic Response™ or Torque Vectoring see On / Off-Road Pack

(5) Contrast roof when selected Autobiography Dynamic includes painted side sills and bumpers. See **Interior Options** for contrast roof colour recommendations (6) Memory functionality added when featured with memory seats ('Style 3' and 'Style 5').

■ Standard □ Optional Δ No Cost Option – Not Available.

Brembo is a registered trademark of Freni Brembo S.p.A

Build & Price
Print
Save
Exit

STEP 6 CHOOSE YOUR OPTIONS

Wheels and Wheel Options

	OPTION CODE	HSE	HSE DYNAMIC	AUTOBIOGRAPHY DYNAMIC	LIST PRICE	VAT	RETAIL PRICE
20 inch five split-spoke 'Style 12'	029SB	■	△	△	£0.00	£0.00	£0.00
21 inch six split-spoke 'Style 10'	029TA	–	–	△ (1)	£0.00	£0.00	£0.00
21 inch five split-spoke 'Style 14'	029SD	□	△	△	£0.00	£0.00	£0.00
21 inch five split-spoke Diamond Turned finish 'Style 15'	029SE	□	■	–	£1,333.33	£266.67	£1,600.00
		–	■	□ (2)	£666.67	£133.33	£800.00
		□	–	–	£1,666.67	£333.33	£2,000.00
22 inch five split-spoke 'Style 6'	029SF	–	□	□	£1,000.00	£200.00	£1,200.00
		–	–	□ (1)	£666.67	£133.33	£800.00
22 inch five split-spoke 'Style 17'	029SY	–	–	□	£1,000.00	£200.00	£1,200.00
		–	–	□ (1)	£666.67	£133.33	£800.00
Tyre repair system (3)	029FJ	△	△	△	£0.00	£0.00	£0.00
Full size spare wheel (4)	050AQ	□	□	□	£166.67	£33.33	£200.00

Information, Communication and Entertainment

	OPTION CODE	HSE	HSE DYNAMIC	AUTOBIOGRAPHY DYNAMIC	LIST PRICE	VAT	RETAIL PRICE
Meridian™ Surround Sound Audio System (825W) with 19 speakers	025LN	□	□	■	£833.33	£166.67	£1,000.00
Meridian™ Signature Reference Audio System (1700W) with 23 speakers	025LV	□	□	–	£4,166.67	£833.33	£5,000.00
		–	–	□	£3,333.00	£666.67	£4,000.00
Eight-inch rear seat entertainment with remote control and two sets of wireless headphones (one USB in second row) (5) (6)	129AH	□	□	□	£1,250.00	£250.00	£1,500.00
10.2 inch rear seat entertainment with remote control and two sets of wireless headphones (one USB in second row) (5) (7)	129AQ	□	□	□	£2,083.33	£416.67	£2,500.00
Television*	129AA	□	□	□	£666.67	£133.33	£800.00
Touch-screen with Dual View technology (includes one set of wireless headphones) (8)	087AM	□	□	□	£500.00	£100.00	£600.00
InControl™ and Secure – One Year Package (9)	011AD	□	□	□	£829.17	£165.83	£995.00
InControl™ and Secure – Three Year Package (9)	011AB	□	□	□	£1,162.50	£232.50	£1,395.00

(1) SDV6 Hybrid only (2) No cost option for SDV6 Hybrid (3) Required when 5+2 seating features (4) Not available with Powered 5+2 seats (5) Requires Meridian Surround Sound Audio System (825W) and 60:40 folding rear seat with load through (6) Not available with 'Style 7' seats (7) Only available with 'Style 7' seats (8) Requires Meridian Surround Sound Audio System (825W) (9) Available March 2014.

*Whilst Jaguar Land Rover continue to work closely with developing TV standards worldwide, we unfortunately cannot guarantee the TV feature in all countries due to undergoing changes to the broadcast TV standards. The current supported standard can be switched off ahead of any published dates resulting in potential loss of the TV feature in the vehicle.

■ Standard □ Optional △ No Cost Option – Not Available.

Visit landrover.co.uk for more information.

Build & Price
Print
Save
Exit

STEP 6 CHOOSE YOUR OPTIONS

Seating, Interior Features and Finishers

	OPTION CODE	HSE	HSE DYNAMIC	AUTOBIOGRAPHY DYNAMIC	LIST PRICE	VAT	RETAIL PRICE
SEATING							
Climate front seats with heated rear seats (1)	033GQ	<input type="checkbox"/>	<input type="checkbox"/>	■	£416.67	£83.33	£500.00
Climate front seats with climate rear seats (1)	033IN	<input type="checkbox"/>	<input type="checkbox"/>	–	£833.33	£166.67	£1,000.00
		–	–	<input type="checkbox"/>	£416.67	£83.33	£500.00
'Style 5' - 18-way / 18-way passenger front powered seats with electric seat adjustment, armrests and four-way lumbar and power headrest	033UA	<input type="checkbox"/>	<input type="checkbox"/>	■	£250.00	£50.00	£300.00
'Style 7' – 18-way / 18-way powered seats with memory, front seat articulation and massage (2)	033TR	<input type="checkbox"/>	<input type="checkbox"/>	–	£1,083.33	£216.67	£1,300.00
		–	–	<input type="checkbox"/>	£833.33	£166.67	£1,000.00
60:40 folding rear seats with load through	033CW	<input type="checkbox"/>	<input type="checkbox"/>	<input type="checkbox"/>	£83.33	£16.67	£100.00
Powered 5+2 seating (3)	033BI	<input type="checkbox"/>	<input type="checkbox"/>	<input type="checkbox"/>	£1,250.00	£250.00	£1,500.00
Powered 5+2 seating with rear auxillary climate pack (3) (4)	074MW	<input type="checkbox"/>	<input type="checkbox"/>	<input type="checkbox"/>	£1,716.67	£343.33	£2,060.00
STEERING WHEEL							
Leather heated steering wheel with multi-functional controls	032DV	<input type="checkbox"/>	<input type="checkbox"/>	■	£145.83	£29.17	£175.00
TRIM FINISH							
Shadow Zebrano wood veneer (5)	088HB	Δ	Δ	Δ	£0.00	£0.00	£0.00
Dark Grey Oak wood veneer (5)	088GM	Δ	Δ	Δ	£0.00	£0.00	£0.00
Grand Black wood veneer (5)	088HS	<input type="checkbox"/>	<input type="checkbox"/>	<input type="checkbox"/>	£291.67	£58.33	£350.00
Autobiography extended wood veneers including additional ambient lighting	088JC/ 088HZ	–	–	<input type="checkbox"/>	£166.67	£33.33	£200.00
Autobiography extended Grand Black wood veneers including additional ambient lighting	088JD	–	–	<input type="checkbox"/>	£458.33	£91.67	£550.00
Front and rear premium carpet mats	079CA	<input type="checkbox"/>	<input type="checkbox"/>	■	£54.17	£10.83	£65.00
Illuminated aluminium treadplates with Range Rover lettering	048BD	<input type="checkbox"/>	■	■	£500.00	£100.00	£600.00
Morzine headlining (Ebony)	005BJ	<input type="checkbox"/>	<input type="checkbox"/>	Δ	£250.00	£50.00	£300.00
Alston headlining (Cirrus, Ivory or Ebony dependent on colourway)	088HE	<input type="checkbox"/>	<input type="checkbox"/>	■	£833.33	£166.67	£1,000.00

(1) Requires three or four-zone climate control (2) Requires climate front seats (3) Not available with 20 inch alloy wheels. Requires 60:40 load through and Tyre Repair System
 (4) Includes four-zone climate control (5) Please see the **Colour and Trim Matrix** for availability

■ Standard □ Optional Δ No Cost Option – Not Available.

Visit landrover.co.uk for more information.

Build & Price
 Print
 Save
 Exit

STEP 6 CHOOSE YOUR OPTIONS

Safety and Security

	OPTION CODE	HSE	HSE DYNAMIC	AUTOBIOGRAPHY DYNAMIC	LIST PRICE	VAT	RETAIL PRICE
First aid kit	056AZ	<input type="checkbox"/>	<input type="checkbox"/>	<input type="checkbox"/>	£25.00	£5.00	£30.00

Comfort and Convenience Features

	OPTION CODE	HSE	HSE DYNAMIC	AUTOBIOGRAPHY DYNAMIC	LIST PRICE	VAT	RETAIL PRICE
VEHICLE AIDS							
Parallel Parking (1)	086GZ	<input type="checkbox"/>	<input type="checkbox"/>	<input type="checkbox"/>	£375.00	£75.00	£450.00
Parallel Parking / Park Exit / Perpendicular Park / 360 Degree Park Distance Control (1)	086HA	<input type="checkbox"/>	<input type="checkbox"/>	<input type="checkbox"/>	£750.00	£150.00	£900.00
Surround camera system	086GC	<input type="checkbox"/>	<input type="checkbox"/>	<input type="checkbox"/>	£583.33	£116.67	£700.00
Blind spot monitor with closing vehicle sensing (2)	086GH	<input type="checkbox"/>	<input type="checkbox"/>	<input type="checkbox"/>	£333.33	£66.67	£400.00
Blind spot monitor with closing vehicle sensing and reverse traffic detection (2)	086GF	<input type="checkbox"/>	<input type="checkbox"/>	<input type="checkbox"/>	£416.67	£83.33	£500.00
Wade Sensing™	075EA	<input type="checkbox"/>	<input type="checkbox"/>	<input type="checkbox"/>	£208.33	£41.67	£250.00
Wade Sensing™ plus blind spot monitor with closing vehicle sensing and reverse traffic detection (3)	074NG	<input type="checkbox"/>	<input type="checkbox"/>	<input type="checkbox"/>	£625.00	£125.00	£750.00
Lane Departure Warning (2) (4) (5)	086BC	<input type="checkbox"/>	<input type="checkbox"/>	<input type="checkbox"/>	£333.33	£66.67	£400.00
Lane Departure Warning with Traffic Sign Recognition (2) (4) (5)	086DB	<input type="checkbox"/>	<input type="checkbox"/>	<input type="checkbox"/>	£500.00	£100.00	£600.00
Adaptive Cruise Control (ACC) with Queue Assist, intelligent emergency braking and active seat belts	065AG	<input type="checkbox"/>	<input type="checkbox"/>	■	£1,250.00	£250.00	£1,500.00
HomeLink® (6)	025FG	<input type="checkbox"/>	<input type="checkbox"/>	<input type="checkbox"/>	£166.67	£33.33	£200.00
Soft door close (7)	076FC	<input type="checkbox"/>	<input type="checkbox"/>	<input type="checkbox"/>	£366.67	£73.33	£440.00
Remote park heat	043AV	<input type="checkbox"/>	<input type="checkbox"/>	<input type="checkbox"/>	£833.33	£166.67	£1,000.00
Extra large additional washer bottle	039BB	<input type="checkbox"/>	<input type="checkbox"/>	<input type="checkbox"/>	£25.00	£5.00	£30.00

(1) Only available with rear view camera or surround camera, front and rear parking aids (2) Only available with auto dimming exterior mirrors (3) Only available with auto dimming exterior mirrors and surround camera (4) Not available with HomeLink® (5) Requires Automatic headlamps with High Beam Assist (AHBA) (6) Requires auto dimming interior mirror (7) Requires keyless entry

■ Standard □ Optional △ No Cost Option – Not Available.

Build & Price
Print
Save
Exit

STEP 6 CHOOSE YOUR OPTIONS

Comfort and Convenience Features (continued)

	OPTION CODE	HSE	HSE DYNAMIC	AUTOBIOGRAPHY DYNAMIC	LIST PRICE	VAT	RETAIL PRICE
INTERIOR FEATURES							
Twin blade sunvisor	115AP	<input type="checkbox"/>	<input type="checkbox"/>	<input type="checkbox"/>	£41.67	£8.33	£50.00
Front centre console cooler compartment	038EA	<input type="checkbox"/>	<input type="checkbox"/>	<input checked="" type="checkbox"/>	£187.50	£37.50	£225.00
Three-zone climate control	022BC / 022BK (Hybrid only)	<input type="checkbox"/>	<input type="checkbox"/>	<input checked="" type="checkbox"/>	£375.00	£75.00	£450.00
Four-zone climate control	022BG / 022BL (Hybrid only)	<input type="checkbox"/>	<input type="checkbox"/>	<input type="checkbox"/>	£750.00	£150.00	£900.00
Customer configurable interior mood lighting	064FC	<input type="checkbox"/>	<input type="checkbox"/>	<input checked="" type="checkbox"/>	£375.00	£75.00	£450.00
Customer configurable interior mood lighting	064FC	<input type="checkbox"/>	<input type="checkbox"/>	<input checked="" type="checkbox"/>	£191.67	£38.33	£230.00
LOADSPACE							
Loadspace stowage rails	135AH	<input type="checkbox"/>	<input type="checkbox"/>	<input type="checkbox"/>	£225.00	£45.00	£270.00

[Build & Price](#)

[Print](#)
[Save](#)
[Exit](#)

KEY FEATURES



[Build & Price](#)

[Print](#)
[Save](#)
[Exit](#)

KEY FEATURES



Terrain Response® 2

Next generation Terrain Response® 2 is designed to monitor driving conditions and automatically optimises the vehicle's settings to suit the terrain. This gives you the ultimate in ride comfort on all surfaces including grass/gravel/snow, mud/ruts, sand and rock. And even if it is not in auto mode, it will let you know if you should select low range and off-road ride height.



Eight-speed Automatic Transmission with CommandShift® 2

All petrol and diesel engines in the all-new Range Rover Sport are paired with the advanced electronically controlled eight-speed automatic gearbox which has been tuned by Land Rover engineers to combine silky smooth shifting with exceptionally rapid responses and outstanding fuel economy. With eight closely-spaced ratios, gear changes are almost imperceptible, with each shift completed in just 200 milliseconds.



Electric Power Assisted Steering (EPAS)

The Electric Power Assisted Steering (EPAS) system helps to deliver accurate, consistent steering and agile cornering. Power assistance is speed-sensitive so the steering is light and responsive at lower speeds and firmer at higher speeds.



Dynamic Response

Dynamic Response transforms vehicle handling through hydraulic roll and yaw control, optimising on road performance and passenger comfort. The system works in addition to Adaptive Dynamics which monitors the vehicle's movements over 500 times a second, reacting to driver or road inputs virtually instantaneously, helping to give greater control and minimising body roll for a composed ride.



Electronic Air Suspension

The all-new Range Rover Sport features a next-generation four corner air suspension system which delivers class-leading comfort and capabilities both on and off-road. The air suspension system automatically switches between two ride heights when the off-road setting is selected. Maximum ground clearance is increased by 65mm above normal ride height at speeds less than 30mph.



Torque Vectoring

Torque Vectoring uses the electronic differential and vehicle's brake system to constantly balance the distribution of engine torque between the four wheels when cornering, resulting in improved grip, steering and reduced understeer whilst maintaining a consistent speed.

Visit landrover.co.uk for more information.

[Build & Price](#)

[Print](#)
[Save](#)
[Exit](#)

KEY FEATURES

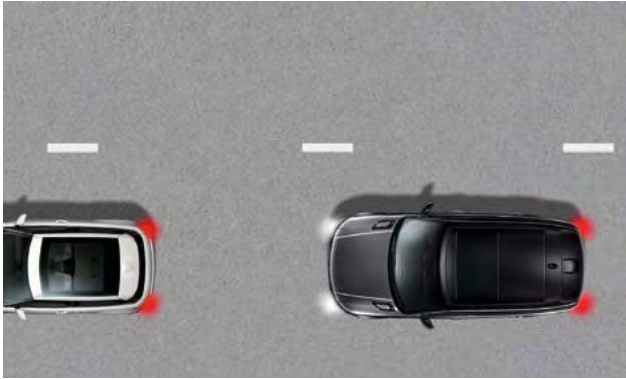

Adaptive Cruise Control with Queue Assist, Intelligent Emergency Braking and Active Seat Belts

Adaptive Cruise Control (ACC) is an improved cruise control system that helps maintain a pre-set gap from the vehicle in front, even if it changes speed. Queue Assist extends the ACC functionality. It is designed to allow the vehicle to come to a stop when it reaches a traffic queue.

Intelligent Emergency Braking uses radar to detect vehicles travelling in the same direction and automatically reduces impact speed if it calculates that a frontal collision is unavoidable.



Traffic Sign Recognition with Lane Departure Warning

Traffic Sign Recognition uses the forward-looking camera to recognise speed limit signs and display the information in the instrument cluster.

Lane Departure Warning uses a forward-looking camera mounted in front of the rear view mirror to monitor lane markings on both sides of the vehicle. It gives a discrete warning in the form of a vibration through the steering wheel when the vehicle drifts out of its lane, triggering the indicators. (System operational at certain speeds).



Blind Spot Monitor with Closing Vehicle Sensing

Using sensors mounted on the sides and the rear bumper, these systems are designed to see what you might miss. When a vehicle enters a blind spot, a warning light will show in the corresponding door mirror.

Closing Vehicle Sensing scans a zone much further behind the vehicle, to help detect vehicles which are closing quickly from behind and which could cause a threat during a lane change manoeuvre.

Also available with Reverse Traffic Detection.



InControl™

Land Rover InControl™ uses in-vehicle mobile technology to safely and securely connect your world, your Land Rover and your services. Use the smartphone app to check the status of your vehicle wherever you are and have the reassurance of emergency help if required from SOS Emergency Call and Optimised Land Rover Assistance. If your vehicle is stolen, InControl Secure enables it to be tracked aiding recovery.

Available March 2014.



Park Assist

The all-new Range Rover Sport has been designed and engineered to meet the needs of today. Parking is made simpler with the aid of Parallel Parking, a feature which can be further enhanced with the addition of Parallel Exit, Perpendicular Parking and 360° Park Distance Control. Whether you're manoeuvring around tight corners or negotiating traffic, the vehicle is agile.



Full Thin Film Transistor (TFT) Instrument Panel

The 12.3 inch virtual instrument panel uses state-of-the-art, high-resolution display technology and the latest colour graphics for clear communication of the main vehicle functions and data. With elegant virtual dials resembling 3D chrome it can be tailored to display only information that is relevant to the current driving situation.

Build & Price

Print
Save
Exit

KEY FEATURES



Interior Mood Lighting

New levels of ambient refinement and personalisation have been reached with the option of customer configurable lighting. Using a combination of coloured LEDs, this feature allows occupants to vary the shade, changing the ambience of the cabin to suit their mood. There are ten colours in total to suit every taste and mood, ranging from Spark Blue through to Ice White and Racing Red.



Dual View Touch-Screen

Dual View technology enables driver and front passenger to view completely independent display content via the Touch-screen, so the passenger can watch TV while the driver follows navigational instructions. Supplied with one pair of WhiteFire® wireless digital headphones.



Wade Sensing™

Using sensors in the wing mirrors when the vehicle is wading, it alerts the driver if the water is too deep. The feature is particularly useful when visibility is poor or when driving at night. This feature provides real-time pictorial wading information, including the depth of the water in relation to the vehicle, as well as maximum wading capability of the vehicle.



Audio

The Meridian™ audio technology gives you stunning sound quality. The top of the range system features Meridian Signature Reference Audio with 23 speakers including subwoofer and 3D surround sound.

WhiteFire® is a registered trademark of Unwired Technology LLC and any use of such marks by Land Rover is under license.



Rear Seat Entertainment

The Rear Seat Entertainment System provides entertainment for rear passengers, with a choice of two eight-inch integrated or 10.2-inch video screens, two pairs of WhiteFire® wireless digital headphones, one USB in the second row and a dedicated remote control.

It includes 'Journey Status', a Navigation Summary screen which displays a pop-up for the rear occupant detailing the time and distance to destination.



Climate Control and Park Heat

Choose three-zone climate control to benefit from separate controls for driver, front passenger and rear seats. The optional four-zone climate control helps give more control to rear passengers. Remote Park Heat with Timed Climate enables you to pre-heat or cool the vehicle with remote control and seven-day timer.

[Build & Price](#)

[Print](#)
[Save](#)
[Exit](#)

DIMENSIONS AND CAPABILITIES



Wheelbase 2,923mm



Height 1,780mm



Front wheel track 1,690mm



Rear wheel track 1,685mm



Width 2,073mm mirrors folded
Width 2,220mm mirrors out

Obstacle Clearance

Off-road height 278mm
Standard ride height 213mm

Standard Ride Height

With roof rails 1,780mm
With roof antenna 1,801mm
With panoramic roof open 1,817mm
Access height air suspension setting will reduce each of the above by 50mm

Loadspace Capacity

Rear seats upright
Height 767mm, Width 1,285mm
Loadspace volume 784 litres
Loadspace width between arches 1,120mm
Length at floor 1,043mm-1,143mm

Rear seats forward
Height 767mm, Width 1,285mm
Loadspace volume 1,761 litres
Loadspace width between arches 1,120mm
Length at floor 1,871mm

Headroom

Maximum front headroom with panoramic roof 1,002mm
Rear headroom 993mm



	A	B	C
Ride Height			
Approach Angle	33.0°	27.2° (25.9°)	31.0°
Off-road (Hybrid)	24.3°	19.4° (18.9°)	24.9°
Standard (Hybrid)			
Ramp Angle			
Departure Angle			



Overall length 4,850mm

Turning Circle

Kerb-to-kerb 12.1m
Wall-to-wall 12.5m
Turns lock-to-lock 2.78



Wading Depth

Maximum wading depth 850mm

[Build & Price](#)

[Print](#)
[Save](#)
[Exit](#)

TECHNICAL SPECIFICATION / PERFORMANCE AND KEY DATA

	SDV6 292HP	SDV6 HYBRID 340HP	SDV8 339HP	V8 SUPERCHARGED 510HP
ENGINE DATA				
Capacity (cc)	2,993	2,993	4,367	4,999.7
No. of cylinders	6	6	8	8
Cylinder layout	Longitudinal V6	Longitudinal V6	Longitudinal V8	Longitudinal V8
Valves per cylinder	4	4	4	4
Bore (mm)	84	84	84	92.5
Stroke (mm)	90	90	98.5	93
Compression ratio (:1)	16.1	16.1	16.1	9.5
Maximum power hp (kW) /rpm	292 (215) / 4,000	340 (250) / 4,000**	339 (250) / 3,500	510 (375) / 6,000 - 6,500
Maximum torque Nm /rpm	600 / 2,000	700 / 1,500 - 3,000**	700 / 1,750 - 3,000	625 / 2,500 - 5,500
BRAKES				
Front type	Ventilated disc	Ventilated disc	Ventilated disc	Ventilated disc
Front diameter (mm)	380	380	380	380
Rear type	Ventilated disc	Ventilated disc	Ventilated disc	Ventilated disc
Rear diameter (mm)	365	365	365	365
Park Brake	Electric Park Brake (EPB) integrated into brake caliper			
WEIGHTS (kg)				
Weight from	2,115	2,372	2,398	2,335
Maximum laden weight	3,000	3,150	3,200	3,050
Maximum mass on each axle (front)	1,500	1,500	1,550	1,500
Maximum mass on each axle (rear)	1,775	1,775	1,775	1,775
TOWING (kg)				
Unbraked trailer	750	750	750	750
Maximum towing	3,500	3,000	3,500	3,500
Maximum coupling point / nose weight	150	120	150	150
Maximum vehicle and trailer combination / Gross Train Weight	6,500	6,150	6,700	6,550
ROOF CARRYING (kg)				
Maximum roof load (including Roof Rails)	100	100	100	100
PERFORMANCE AND FUEL ECONOMY				
Maximum speed (mph)	130 (138*)	130 (140*)	130 (140*)	140 (155*)
Acceleration (secs) 0-60mph	6.8	6.4	6.5	5.0
Fuel tank capacity – usable (litres)	80	80	105	105
Diesel Particulate Filter (DPF)	■	■	■	–

*Only available on Dynamic Pack models. **When combined with electric motor.
 ■ Standard – Not Available.

ACCESSORIES



Visit [landrover.com/gb/en](https://www.landrover.com/gb/en) for more information.

[Build & Price](#)

[Print](#)
[Save](#)
[Exit](#)

ACCESSORIES

Style



20 Inch Five Split-Spoke Gloss Black Finish – 'Style 18'
VPLWW0090 £2,640.00 (set of four)

Rim only. Centre caps available separately.



Side Protection Tubes
VPLWP0154 £822.00

Manufactured from stainless steel with a highly polished finish, this product helps protect the vehicle in off-road conditions. Its rugged off-road appearance complements the vehicle's exterior design.



Illuminated Rear Loadspace Treadplate Finisher
VPLWS0211PVJ – Ebony £360.00
VPLWS0211AAM – Espresso £360.00

Manufactured from stainless steel with a bright finish, protecting the loadspace trim when loading or unloading. Providing a premium finish to the loadspace with subtle illumination.



Noble Plated Mirror Caps
VPLGB0073 £168.00

Noble Plated Mirror Caps complement the Range Rover Sport's exterior styling cues.



Styled Valve Caps
LR027664 – Black Jack - £26.40
LR027666 – Union Jack - £20.00
LR027560 – Land Rover - £20.00
LR027663 – Range Rover - £20.00

Exclusive range of styled valve caps providing choice of Land Rover, Range Rover branded caps or Union Jack designs. Provide a subtle styling enhancement.



Stainless Steel Front Undershield
VPLWP0162 £420.00

The off-road inspired styled undershield features a premium bright polished finish for the front of the vehicle.

Prices correct to 30th June 2014. All prices subject to change. Please contact your dealership for the latest pricing. Prices include VAT but exclude dealership fitting costs.

[Build & Price](#)

[Print](#)
[Save](#)
[Exit](#)

ACCESSORIES

Touring



Roof Rails*
VPLWR0104 – Black Finish £480.00 VPLWR0103 – Silver Finish £480.00

Roof Rails facilitate easy fitment of cross bars. Pre-set positioning points ensure cross bars are fixed in optimum position for weight distribution and dynamics.

Roof Rail Ditch Finishers required for fitment with Roof Rails – £198.00
(VPLWR0108 – Black / VPLWR0109 – Silver)

*Roof Rails and Cross Bars are required for all Land Rover roof mounted accessories. Objects placed above the roof mounted satellite antenna may reduce the quality of the signal received by the vehicle and could have a detrimental effect on the navigation and satellite radio system, if fitted.



Cross Bars*
VPLGR0081 £342.00

T-track design utilises the full length of the bars, providing space to mount multiple accessories. Aerodynamic profile minimises drag and noise. Roof rails not included.



Luggage Box*
VPLVR0062 £535.00

The gloss black finish Luggage Box opens from both sides and includes power-grip mounting for easy and quick fixing to the roof bars. Lockable for security. Volume 410 litres. Maximum payload 75kg**.



Premium Seatback Stowage
VPLVS0182 £168.00

Manufactured from the same premium leather offered on the vehicle complemented with soft touch interior lining and magnetic button clasps.



Electric Cool Bag
VUP100140L £190.00

Powered by the 12 volt auxiliary socket. Thermostatically controlled temperature. Easy clean interior surface. Height 380mm, length 380mm, width 220mm. Volume 14 litres.



iPad Holder
iPad 1 Holder - VPLVS0164 £166.00 iPad 2 Holder - VPLVS0165 £166.00

Provides secure mounting for your iPad. Rear seat facing, attaches to the head restraint posts. iPad® is a registered trademark of Apple Inc., registered in the US and other countries.

Prices correct to 30th June 2014. All prices subject to change. Please contact your dealership for the latest pricing. Prices include VAT but exclude dealership fitting costs.

[Build & Price](#)

[Print](#)
[Save](#)
[Exit](#)

ACCESSORIES

Sporting



Electrically Deployable Tow Bar
VPLWT0111 £1,596.00

The Electrically Deployable Tow Bar is stowed discreetly behind the bumper, providing a clean attractive finish. It is designed to deploy/stow in 12 seconds. Approved for up to 3,500kg trailer load.



Tow Bar Mounted Bike Carrier
VPLVR0066 – Two Bike Carrier* £521.00

Tow bar mounted bike carrier available for two, three or four bikes. Featuring LED lighting, licence plate mount, a quick release design for ease of use and lockable for security. Maximum load capacity 60kg (on the four bike carrier).

Tow Bar Mounted Bike Carrier can be used with either Multi-Height Tow Bar and Armature – Part No: VPLWT0112 or Electrically Deployable Tow Bar – Part No: VPLWT0111



Fixed Side Step
VPLGP0114 £804.00

The Fixed Side Steps aid entry and exit to the vehicle and improve access to the roof. Design features include Range Rover branding and exterior bright work to complement vehicle styling cues. Not compatible with Wade Sensing.



Loadspace Liner Tray
VPLWS0224 £186.00

This liner provides superior protection to the loadspace floor and side wall carpets from dirty or wet equipment.

*Heat Shield required – VPLWR0124.



Door Sill Outer Treadplate
VPLWS0207 £216.00

An aluminium enhancement for the outer door sills featuring a laser etched 'Sport' motif.



Load Retention Net
VUB503130 £100.00

Utilises loadspace tie-down points. Includes floor net and two ratchet straps. Strap length approximately 2 metres.

Prices correct to 30th June 2014. All prices subject to change. Please contact your dealership for the latest pricing. Prices include VAT but exclude dealership fitting costs.

[Build & Price](#)

[Print](#)
[Save](#)
[Exit](#)

ACCESSORIES

Outdoor



Deployable Side Steps
VPLWP0191 and
VPLWP0192 £1,864.80
VPLWP0177 £138.00

VPLWP0173 £26.40
VPLWP0178 / VPLWP0179* £130.80
VPLWP0167 £60.00

These smart, practical steps make it easier to get in and out of the vehicle. Neatly stowed under the sills, the Side Steps automatically deploy as soon as the door is opened, or when activated by the key fob. They stow automatically when the door is closed.

*5+2 Seating equipped vehicles.



Front Mudflaps
VPLWP0167 £60.00
Rear Mudflaps
VPLWP0166 £60.00

Mudflaps reduce spray and help protect the paintwork. Supplied as a pair.



Loadspace Mat – Rubber
VPLWS0225 £162.00

Range Rover branded rubber mat helps to protect the rear loadspace carpet from general dirt. Rubber mat extension for protection of the back of the rear seats when folded down also available – Part No: VPLWS0223



Luggage Divider – Full Height
VPLWS0235 £312.00

The Luggage Divider is designed to prevent cargo from entering the passenger compartment. It incorporates a useful integral ski hatch that allows longer items to be carried where a suitable rear seat option is fitted.



Rubber floor mats
VPLWS0189 £120.00

Rubber footwell mats for front and second row occupants help provide protection from general dirt.



Loadspace Retention Kit
VPLG50171 £138.00

Pack of attachments that fix into the loadspace rails via a quick lock/quick release system to provide a flexible solution for retaining items. The attachment pack includes a retractable strap with inertia reel, telescopic rod and stowage bag.

Prices correct to 30th June 2014. All prices subject to change. Please contact your dealership for the latest pricing. Prices include VAT but exclude dealership fitting costs.

[Build & Price](#)

[Print](#)
[Save](#)
[Exit](#)

Other



Outdoor Car Cover
VPLWC0061 £360.00

All weather tailored cover protects your Range Rover Sport from the elements.



Windscreen Sun Shield
VPLWS0231 £108.00

Helps to keep the vehicle interior cool in hot weather.



Stainless Steel Pedals
VPLGS0161 £102.00

Stainless Steel pedals feature a bright design and hidden fixings for a clean finish.



Premium Carpet Mats
LR041633 – Ebony £300.00
LR041632 – Espresso £300.00

2050g weight deep pile carpet mats with waterproof backing.

*Rim only. Centre caps available separately

Prices correct to 30th June 2014. All prices subject to change. Please contact your dealership for the latest pricing. Prices include VAT but exclude dealership fitting costs.



22 Inch Forged Five Split-Spoke Gloss Black Finish – 'Style 26'
VPLWW0089* £3,120.00 (set of four)



22 Inch Forged Five Split-Spoke Technical Grey Finish – 'Style 25'
VPLWW0087* £3,240.00 (set of four)

[Build & Price](#)

[Print](#)
[Save](#)
[Exit](#)



[Build & Price](#)

[Print](#)
[Save](#)
[Exit](#)



BY APPOINTMENT TO
HER MAJESTY THE QUEEN
MANUFACTURERS OF
MOTOR VEHICLES
JAGUAR LAND ROVER LIMITED
COVENTRY



BY APPOINTMENT TO
HRH THE DUKE OF EDINBURGH
MANUFACTURERS OF
MOTOR VEHICLES
JAGUAR LAND ROVER LIMITED
COVENTRY



BY APPOINTMENT TO
HRH THE PRINCE OF WALES
MANUFACTURERS OF
MOTOR VEHICLES
JAGUAR LAND ROVER LIMITED
COVENTRY

IMPORTANT NOTICE: Jaguar Land Rover Limited is constantly seeking ways to improve the specification, design and production of its vehicles and alterations take place continually. Whilst every effort is made to produce up to date literature, this brochure should not be regarded as an infallible guide to current specifications, nor does it constitute an offer for the sale of any particular vehicle. Distributors and dealers are not agents of Jaguar Land Rover Limited by any express or implied undertaking or representation.

All Land Rover Approved Accessories fitted by a Land Rover Dealer within one month or 1,600 kilometres/1,000 miles (which ever occurs first) of the handover of a new registered vehicle will benefit from the same warranty terms and period of cover as the vehicle warranty. Accessories purchased outside of these parameters will be subject to a 12 month unlimited mileage warranty. All Land Rover Approved Accessories are rigorously tested to the same exacting standards as those applied to our vehicles. Performance in extreme hot and cold temperatures, corrosion resistance, impact and airbag deployment highlight some of the exhaustive product testing carried out to ensure accessories are both durable and importantly, continue to comply with current legislation.

All our accessories are designed to be an integral part of Land Rover vehicles. While many items such as roof carriers are simple to fit, some products require specialist tools and diagnostic equipment to ensure correct integration with the vehicle structure and electrical systems. These products vary from market to market, please consult your Land Rover Dealer who will be pleased to advise you on current specifications and any query you may have.

The colours reproduced here are subject to the limitations of the printing process and may therefore vary slightly from the actual vehicle. The company reserves the right to alter or withdraw any colour finish without notice. Some of these colours may not be obtainable in your country. Please check availability of colours and current specifications with your Land Rover Dealer. Distributors and dealerships are not agents of Jaguar Land Rover Limited and have absolutely no authority to bind Jaguar Land Rover Limited to any express or implied undertaking or representation.

Jaguar Land Rover Registered Office:
Abbey Road, Whitley, Coventry CV3 4LF
United Kingdom.

Registered in England and Wales: Number 1672070

landrover.co.uk

© Jaguar Land Rover Limited 2013.

Keep me informed



Build & Price

Print
Save
Exit

