



The Audi RS 6 Avant

Pricing and Specification Guide
Valid from June 2015

Personalising your Audi RS 6 Avant

This guide has been designed to help you tailor and price your Audi RS 6 Avant quickly and logically. At the back, you will find information on CO2 emissions-based taxation and the other services offered by Audi, including Finance and Insurance. You can also configure your Audi RS 6 Avant online at audi.co.uk



Get more from this brochure with the free Audi Vision app.

Audi Vision brings our brochures to life through Augmented Reality. It works by recognising images on a page through your device's camera. Suitable for phones or tablets, download it for free from the App Store or Google Play. Once downloaded, simply open the app and scan the cover of your guide. Then look out for any page with the Audi Vision logo, you can then hold your device over the page and watch as you get exclusive access to extra images, information and video content.



The Audi RS 6 Avant

Audi Matrix LED headlights	8
Performance	10
Engine	12
Transmission	13
quattro®	14
Technology	20
Audi Connect	22

Model details and prices

Standard model equipment	24
Model prices	28

Colour and upholstery

Paint	30
Upholstery and seats	34
Colour and trim guide	38

Inlays	40
--------	----

Options

Wheels and tyres	44
Packages	47
Performance	49
Audio and communication	50
Exterior equipment	52
Safety and security	53

Looking after your Audi

Audi Complete and warranty	54
Merchandise	57
Audi Difference	58

Technical details

Technical data	59
Dimensions	60
Pricing and Additional information	61





Vorsprung durch Technik

Three words that express the very essence of Audi. Vorsprung durch Technik isn't a slogan. It's our way of seeing the world. It is the driving force behind our history of innovation that continues into the 21st century. Indeed, many technologies that Audi pioneered remain in our cars today. Some are milestones in the history of the motorcar. From our beginnings in 1899, to the Auto Union team's Grand Prix successes in the 1930s and our more recent wins at Le Mans, we have always been at the forefront of the motor industry.

Vorsprung durch Technik makes us who we are. To see more of its influence, just read on.

Introducing the RS 6 Avant

The RS series is the culmination of our proud motorsport heritage. The latest addition in the range is the RS 6 Avant. The result of many years of technical expertise – on roads and racetracks all over the world – the RS 6 Avant brings together astonishing performance with remarkable luxury and refinement.

Exterior styling is unmistakable; with signature RS hallmarks such as flared wheel arches and enhanced body styling. And with the 560PS V8 twin turbo engine delivering 0-62mph in just 3.9 seconds, it's clearly a car with our racing heritage in its genes. Here, the story continues; with more responsiveness and efficiency than you ever thought possible.





Matrix LED lights

**That turn night into day.
And more.**

The Audi RS 6 Avant's cutting-edge Matrix LED headlights don't just produce a light that is similar in colour to daylight. They also incorporate remarkable technology that adapts automatically to the car's surroundings.

Fitted as standard, sensors and an inbuilt camera allow Matrix LED headlights to detect the rear and oncoming headlights of other road users, as well as ambient light in built-up areas. The technology then reacts by dipping individual LEDs to prevent dazzle, while still fully illuminating the remainder of the road.

Using the vehicle's navigation data, Matrix LED technology can even anticipate corners, adjusting LEDs as you negotiate the bend. The result is a much wider visual range, benefitting both you and other road users. Dynamic sweeping indicators complete the striking look both at the front and rear.







Performance

The engineering behind the power

A car as powerful as an RS needs an equally powerful braking system. So each 19-inch RS brake disc is internally ventilated and perforated for enhanced performance, with a special 'floating' friction ring designed to handle high temperature loads. And for even more stopping power, you can upgrade to our 20-inch high-performance brake system with carbon-reinforced, ventilated and perforated ceramic brake discs.

There are more features available to complement the RS 6 Avant's performance. The optional RS Sports suspension with Dynamic Ride Control has a special shock absorber system that counteracts pitch and body roll, giving you an overall feeling of stability in even the most demanding corners. Add dynamic steering and you'll benefit from enhanced handling and even more precise steering at high speeds.

Power when you need it most

An innovative 4.0-litre V8 TFSI engine sets the RS 6 Avant apart – and keeps it there. That's because it features Le Mans winning fuel-injection technology which enhances efficiency, power and torque, making it capable of taking you from 0-62mph in just 3.9 seconds.

However, high performance doesn't necessarily equate to higher fuel consumption. Advanced cylinder-on-demand technology automatically shuts down four of eight cylinders when they're not needed – for example when coasting at constant speed on the motorway or in city traffic – so you'll benefit from the efficiency and low emissions of a car with a much smaller engine. But once you reach the open road, the full power of the V8 engine is ready and waiting.

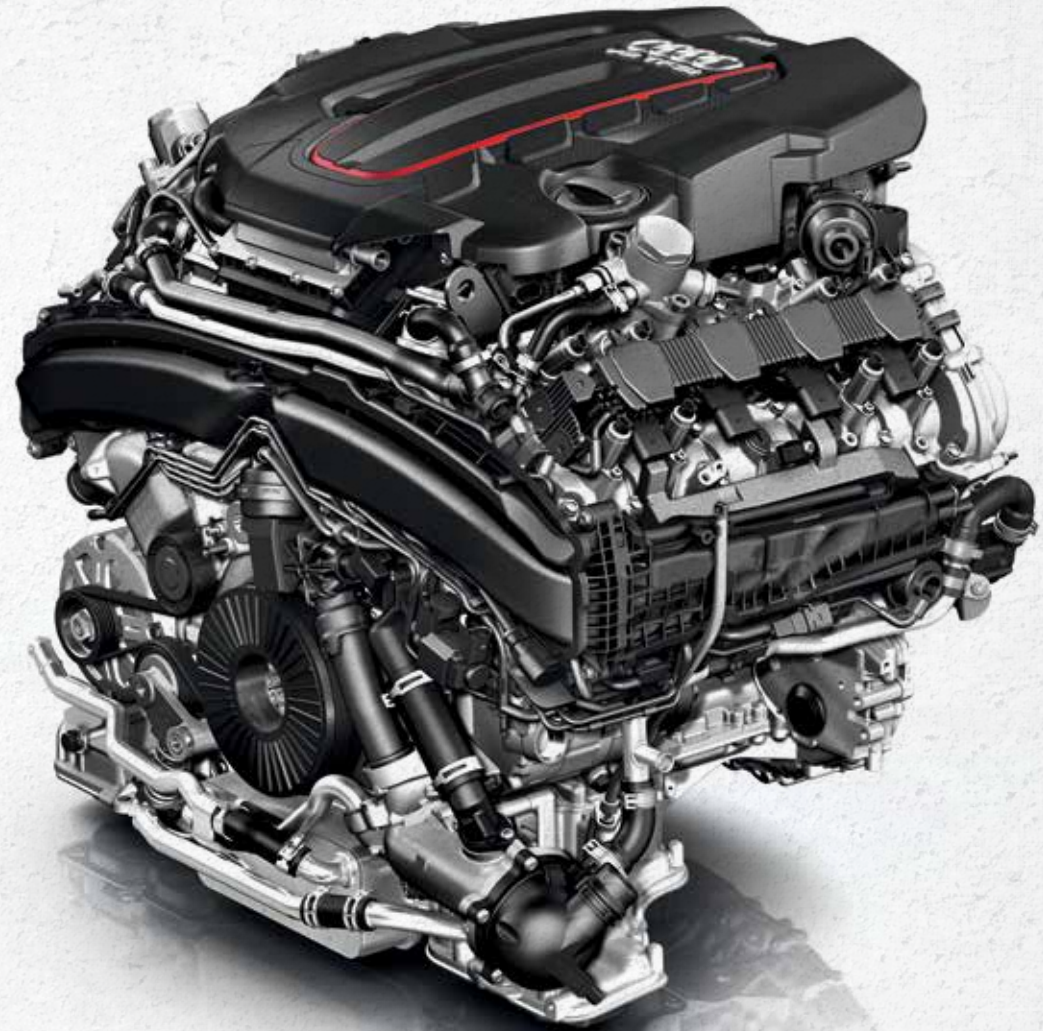

A gearbox with the best of both worlds

The RS 6 Avant features an 8-speed tiptronic transmission with DSP (Dynamic Shift Programme). It's a gearbox that gives you the best of both worlds. Choose between the smooth, economical and uninterrupted power of an automatic, or use the steering wheel paddles or gear lever to switch to manual mode, for a more dynamic drive on inclines and winding roads.

As well as enabling crisp, fast gear changes, tiptronic uses the car's navigation data to tailor itself to your individual driving style, optimising the shifting strategy it uses for different manoeuvres to deliver a more responsive, fuel-efficient drive.

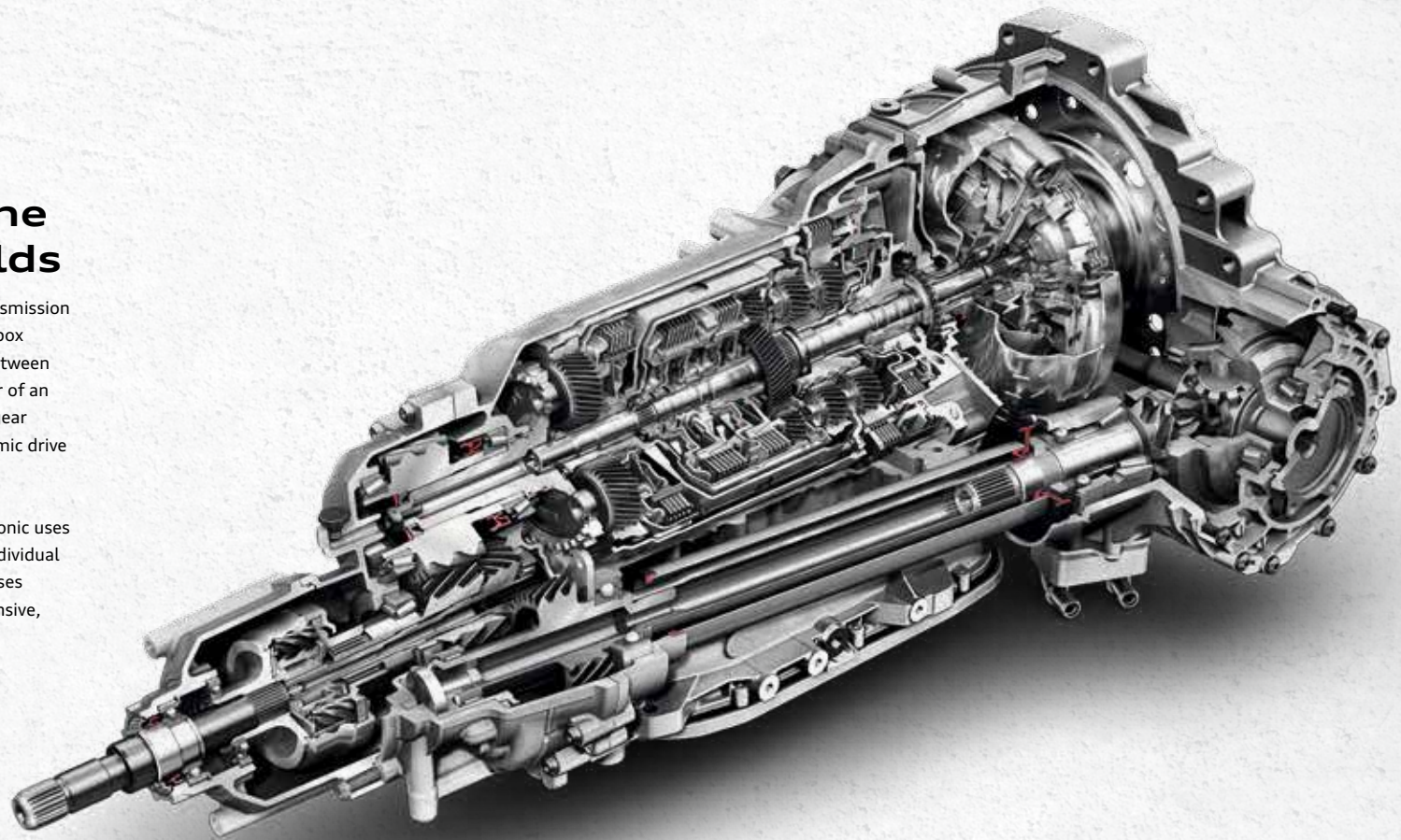

quattro®

A heightened driving experience with ultimate control: it's what makes quattro such a thrilling enhancement to the Audi RS 6 Avant drive.

quattro is Audi's intuitive all-wheel drive system. Constantly analysing grip and distributing power to where it's needed most, the four permanently driven wheels deliver more responsive acceleration and assured grip on all surfaces.

And that's especially true when road conditions change. If one wheel loses traction, quattro makes sure the others compensate to keep the car in control. Giving you a dynamic driving experience with superior handling – even in less-than-perfect driving conditions.

quattro® with Sports differential

Fitted as standard on the RS 6 Avant, quattro with Sports differential takes the driving dynamics of quattro to a whole new level, ensuring outstanding stability and superior acceleration performance.

By distributing torque variably to each of the rear wheels, the car steers even more spontaneously and directly. When cornering, for example, power is redirected to the outside rear wheel, literally pushing the car through the bend. Not only is acceleration more responsive, it requires less steering effort – for a more agile, enhanced drive.











RS 6 Avant interior story

We've introduced a number of finishing touches to the Audi RS 6 Avant interior to make your driving experience unique. You'll find an impressive attention to detail in everything from the luxurious honeycomb design Valcona leather to our inlays and seating options which means that every journey you make will be a personal one.



Technology

Technology is advancing at an ever faster pace, and choosing the right technology for your car is an important decision.

Here at Audi, we strive to make that choice as easy as possible. We have packaged some of our most innovative options together for simplicity but also added value. The most popular of which is our Assistance Pack which features Audi side and lane assist and Adaptive cruise control with Stop&Go. Head-up display is an option and MMI Navigation plus with MMI Touch comes as a standard feature. Audi Phone Box has also been packaged together with Audi Connect to enable the most advanced form of Bluetooth connectivity including Wi-fi hotspot capability. For further details please see page 48, 50 and 51.



MMI Navigation Plus

With HDD-based MMI navigation plus with MMI Touch, you can let yourself be guided to your destination with even greater ease by the 3D map view and 3D displays of places of interest and landmark buildings. Destinations can be entered via speech dialogue, the MMI rotor, or the MMI touchpad which recognises handwriting.



Head-up Display

An advanced system which projects key driving-related information in colour graphic display into your field of vision so there is no need to take your eyes off the road.



Audi Phone Box

The most convenient way to both use and charge your mobile phone, simply by placing it in the Audi Phone Box storage compartment in the front centre armrest. Audi Phone Box creates a 'wireless' connection to the car for improved reception quality, hands-free facility and voice control. Mobile phones can be charged via the USB port.



Audi Side Assist

A clever assistance system for multi-lane roads which helps alert you to other vehicles in your blind spot when changing lanes. Using radar sensors discreetly hidden in the rear bumper, other vehicles are detected and the driver alerted with a visual warning signal in the door mirror.

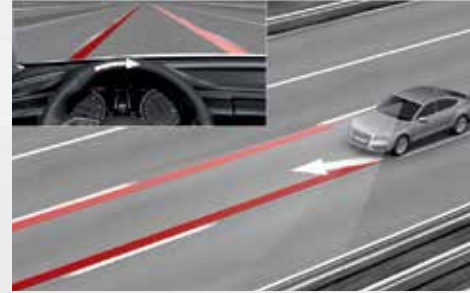

Audi Active Lane Assist

An advanced Audi safety system which helps to keep you in lane by means of gentle steering intervention when lane boundary markings are detected. Particularly useful on long motorway journeys is the new active lane centring feature which gives steering assistance to keep your vehicle in the centre of the lane and enhance your driving comfort.



Adaptive Cruise Control with Stop&Go

The Adaptive cruise control with Stop&Go featuring Pre-sense plus is the most innovative of Audi's driving assist systems. Vehicles ahead are detected by a radar sensor and the distance between the vehicles is kept more or less constant by automatic braking or accelerating. With Pre-sense plus, you add the ultimate in protection with enhanced brake assist functions which can detect and warn of imminent collision threats as well as initiate maximum braking to help avoid or minimise collisions if possible.

Audi



Wi-fi hotspot

Connects your mobile devices to the internet



Email

Your emails can be transmitted to your Audi MMI and read out conveniently†



Text messages

Messages are displayed or read out to you; you can also reply using the dictation function†



Twitter

Enables you to tweet and receive updates on the move. With text-to-speech and other convenient text functions



Weather information

Gives you forecasts and maps for your chosen destination



News online (individual)

Text and images from your favourite news sources with text-to-speech function



Map update online

The map version delivered can be updated free of charge with the first 5 navigation updates which are issued at intervals of 6 months. In conjunction with Audi Connect, the update can be carried out online in the vehicle



City events

Up-to-date information about events – happening at your destination



Points of interest

Search Google™ using voice control



Traffic information online

Complements the dynamic route guidance with real-time traffic flow information for individual stretches of road



myAudi – special destinations

Import individual point-of-interest (POI) lists to your satellite navigation system via the myAudi portal



Train information

Find departure and arrival times and platform information while you're on the road (also available for other types of public transport such as underground systems)



Picturebook navigation

Uses GPS data from your photos to get you to your destination



Country specific information

The legal regulations for a specific country, such as speed limits or whether it is compulsory to carry a high-visibility vest or display a motorway toll sticker, are displayed when crossing a border



Fuel prices

Information on filling stations with the cheapest prices in your selected search area



Parking information

Helps you find car parks nearby and, where available, information on prices and currently vacant spaces



Flight information

Get information about departure and arrival times as well as the corresponding gates and search directly for flight numbers



Access smartphone voice control

Such as Siri (iPhone 4S and higher). By pressing and holding the voice control button on the multifunction leather steering wheel you can access the voice control function of the Bluetooth-connected smartphone directly even while driving



Navigate with Google Earth™ and Google Street View™

Uses high-resolution aerial and satellite images as well as photos to guide you to your destination with ease



Connect



Stay networked on the move.

Being inside your car shouldn't mean losing touch with the outside world. That's why, with Audi Connect, the RS 6 Avant creates a link between you and the internet.

With high-speed, 4G internet access in your car, you can go online to access information, entertainment and Google Earth navigation maps by scrolling, tapping or speaking your commands. Audi Connect can even read aloud your text messages and allows you to dictate a response. And, with a wireless hotspot within the car, passengers can connect up to 8 mobile devices – to browse the internet, download emails, or access social media.

With Audi Connect, the world is at your fingertips.

Please note that an external data source is required to enable Audi Connect online services. Terms and conditions apply to certain Audi Connect functions. Please see page 62 for additional information. *Only available if your mobile phone has the bluetooth profile MAP (Message Access Profile)

Standard model equipment

All RS 6 Avant models have the following items of standard equipment

The RS range incorporates some of our most exclusive, dynamic and sporty models. But in the unmistakable RS 6 Avant, you will find not only the high performance and sophistication you'd expect, but also a surprising level of functionality that makes this a great car for everyday use.

Engine and transmission

75-litre fuel tank

Audi cylinder-on-demand technology

Wheels, tyres and suspension

20" x 9.5J '7-twin-spoke' design alloy wheels with 275/35 R20 tyres and locking wheel bolts

Audi drive select. Changes your car's handling and response at the touch of a button to suit the way you want to drive. Enables the driver to alter the throttle response, the shift point of the automatic transmission, RS Adaptive air suspension, exhaust flap control and the power steering feel between the three pre-set modes: comfort, dynamic, auto or individual mode

Electromechanical power steering

Tyre Mobility System

quattro® permanent all-wheel-drive with Sports differential. The electronically regulated Sports differential distributes variable amounts of driving force to each rear wheel, ensuring outstanding

acceleration performance when cornering and stabilising the vehicle's response to load change. It also ensures better direct steering characteristics and, thanks to less steering effort, more agile handling

RS-specific Adaptive air suspension.

Electronically controlled air suspension with infinitely variable adaptive damping system on all four wheels, with RS-specific tuning. This automatically controls the vehicle level and damping, with four modes: comfort, dynamic, auto and lift, which can all be selected via the MMI system

RS high-performance braking system with brake calipers painted in high-gloss black with RS logo

Lighting

Audi Matrix LED headlights. A direct evolution of Audi's LED headlights, Audi Matrix technology provides maximum and precise illumination at all times without dazzling other road users. The vehicle uses information obtained from multiple sources including the interior mirror camera and navigation system to

identify the appropriate lighting required; using GPS data the vehicle will use high beam, but will automatically switch to dipped lighting when entering built up areas; whilst high beam is in use, and oncoming traffic is detected, the Matrix beam dips or fully extinguishes individual lighting diodes. Matrix beam is capable of establishing and tracking multiple road users and illuminating the appropriate corridors of lights either side of them to maintain maximum visibility of the road and surrounding environment without causing disruption to other drivers. Matrix beam technology includes dynamic front and rear indicators which dynamically sweep from inside to out within 0.15 seconds. This helps to clearly identify not only that the vehicle is turning but in which direction – increasing road safety as it is easier for other road users to determine which way cars are moving in a shorter amount of time

Headlight washers

Darkened rear LED light



20" x 9.5J '7-twin-spoke' design alloy wheels



Valcona leather with honeycomb design and embossed RS logo

Audio and communication

MMI Navigation Plus including MMI Touch. Hard disk navigation with topographical map display, places of interest and town models in 3D. Destinations can be entered via the speech dialogue system or MMI Touch, including 7-digit postcode recognition. Includes electrically extending high resolution 8" colour display. Provides detailed route information: map preview, choice of alternative routes, lane recommendations motorway exits and detailed junction maps. Incorporates MPEG4-compatible DVD player and two SDXC memory card readers. Hard drive for music storage up to 10 GB. Also includes a map update service for downloading the latest navigation data*

MMI Radio Plus

DAB digital radio reception

Colour Driver's Information System (DIS) with 7" display with energy-saving tips and rest recommendations. Shows the radio station or track title, telephone control, menu and other display information from the infotainment system, such as navigation and on-board trip computer with short and long-term trip memory, outside temperature display, digital speedometer and door or boot-open warning. Also includes RS menu with gear changing light, charging pressure and lap timer

BOSE® surround sound

- 14 speakers including centre speaker in the dashboard and subwoofer under the boot floor
- 2 surround sound speakers in the D-pillar
- 12-channel amplifier with a total output of over 600 Watts
- Acoustics specially tuned to the interior
- Surround sound reproduction 5.1
- AudioPilot for noise-compensating volume adjustment
- Powerful, precise bass reproduction

Mobile telephone preparation – bluetooth interface

Audi Music Interface. Universal connection for use with stereo audio sources, USB and MP3 devices including Apple iPod generation 4 onwards (iPod, iPod classic, iPod nano, iPod photo, iPod video, iPod touch). The interface provides charging function (dependent on device). Includes 2 cables to connect your iPod or USB MP3 player device

Exterior equipment

Metallic or pearl effect paint

RS body styling

- Flared front and rear wheel arches
- Front bumper with enlarged air inlets
- Front spoiler
- Honeycomb design grille
- Rear diffuser
- Roof spoiler
- Side sill extensions

Matt-finished aluminium-look door mirror housings, window capping strips, radiator grille frame and front spoiler

Roof rails in matt aluminium

Dual-branch exhaust system with two oval tailpipe trims

Exterior mirrors – heated, electrically adjustable, electrically folding and auto-dimming, with automatic kerb view function which tilts the passenger mirror downwards towards the kerb when reverse gear is engaged. Includes memory function

Power-operated tailgate

Tow bar bracket preparation – the set of parts for retrofitting is available from Audi Accessories or available as an option (see page 52)



Honeycomb design grille



Roof spoiler



Darkened LED rear lights

Standard model equipment

Continued

Interior equipment

RS 3-spoke flat-bottomed leather multi-function steering wheel with gear shift paddles in aluminium-look, contrast stitching and RS emblem

Electrically adjustable steering column – adjustable for height and reach with auto easy entry and exit function, and with memory

Inlays in Carbon

Aluminium-look pedals and footrest

Auto-dimming rear-view mirror

Deluxe 4-zone automatic air conditioning

Ambient lighting package – Includes lighting for the interior and exterior

Interior:

- Entrance lighting
- 2 reading lights at front and rear
- Anti-glare LED illumination for the passenger compartment
- Vanity mirrors at front
- Ambient lighting of the centre console
- Ambient reflected light for inside door trims
- Lighting for door pockets, footwells, and inside door handles
- Reflected lighting for centre console and door inner panels
- Surround lighting for centre console
- Illuminated door sill trims with RS 6 logo
- Glove compartment and luggage compartment lighting

Exterior:

- Courtesy light on the underside of the door handles and LED door handle lighting for easy entry and exit in the dark
- Automatic activation when the doors are unlocked
- Active internal door reflectors

Seating

Valcona leather upholstery

RS Super Sports front seats with driver's side memory function including:

- Stitched honeycomb quilted design with embossed RS logo
- Electrically adjustable seat height
- Electrically adjustable upper backrest angle
- Electrically adjustable seat cushion angle
- Electrically adjustable seat forwards and backwards position
- 4-way electric lumbar support

Heated front seats

Split-folding rear seats



RS 3-spoke flat-bottomed steering wheel



Inlays in Carbon

Assistance systems

Cruise control

Electromechanical parking brake. Includes parking brake function when stationary, drive-off assistance function through automatic release when driving away and emergency braking function whilst driving, acting on all 4 wheels

Hill-hold assist. Holds the vehicle stationary for unlimited periods after stopping on upward and downward slopes

Audi parking system plus. Acoustic and visual parking assist system for front and rear

Rest recommendation system. Analyses driving behaviour based on steering, pedals and gear lever movements. If the system detects a change in driving patterns it can notify the driver of the possible need to take a rest via audio and visual effects

Light and rain sensor

Tyre pressure monitoring system

Safety and security

ISOFIX child seat mounting – for front passenger (with airbag deactivation) and outer rear seats. Including Top Tether attachment point for the outer rear seats

6 airbags

- Front airbags
- Front side airbags
- Curtain airbags

Electronic Stability Control (ESC)

Anti-lock Brake System (ABS)

Anti-Slip Regulation (ASR)

Electronic Differential Lock (EDL)

First-aid kit

Thatcham Category 1 alarm

Tool kit and car jack

Warning triangle



RS instrument panel including RS gear shift light, with Piano black trim surround



Door sill trims with aluminium inlays and RS 6 logo

RS 6 Avant

Engine	Power	Transmission	CO ₂ g/km	Total RRP inc VAT	Recommended OTR
4.0 TFSI quattro	560PS	8-speed tiptronic	223	£77,465.00	£78,790.00

Please note: The maximum power output figures are quoted in PS (or Pferdestärke, which is the metric equivalent of brake horsepower). To convert to brake horsepower, divide the PS figure by 1.0139.

Recommended On-The-Road (OTR) retail prices include: delivery charge, half a tank of fuel, number plates at £630.00 (inc. VAT), Road Fund Licence (which may vary depending on model/transmission; see page 62 for details) and first registration fee at £55.00. Vehicle Excise Duty correct at time of going to print, but this may alter to reflect any change in the applicable VED rate.

RRP – Recommended Retail Price. VAT is calculated at 20% but this may alter to reflect any change in the applicable VAT rate.





Paint

We believe that every part of your car should have a personal touch. Which is why you can choose from a wide range of paint colours and finishes, from standard shades to metallic and pearl effects. We can even mix a customised colour for you to create the perfect fit.



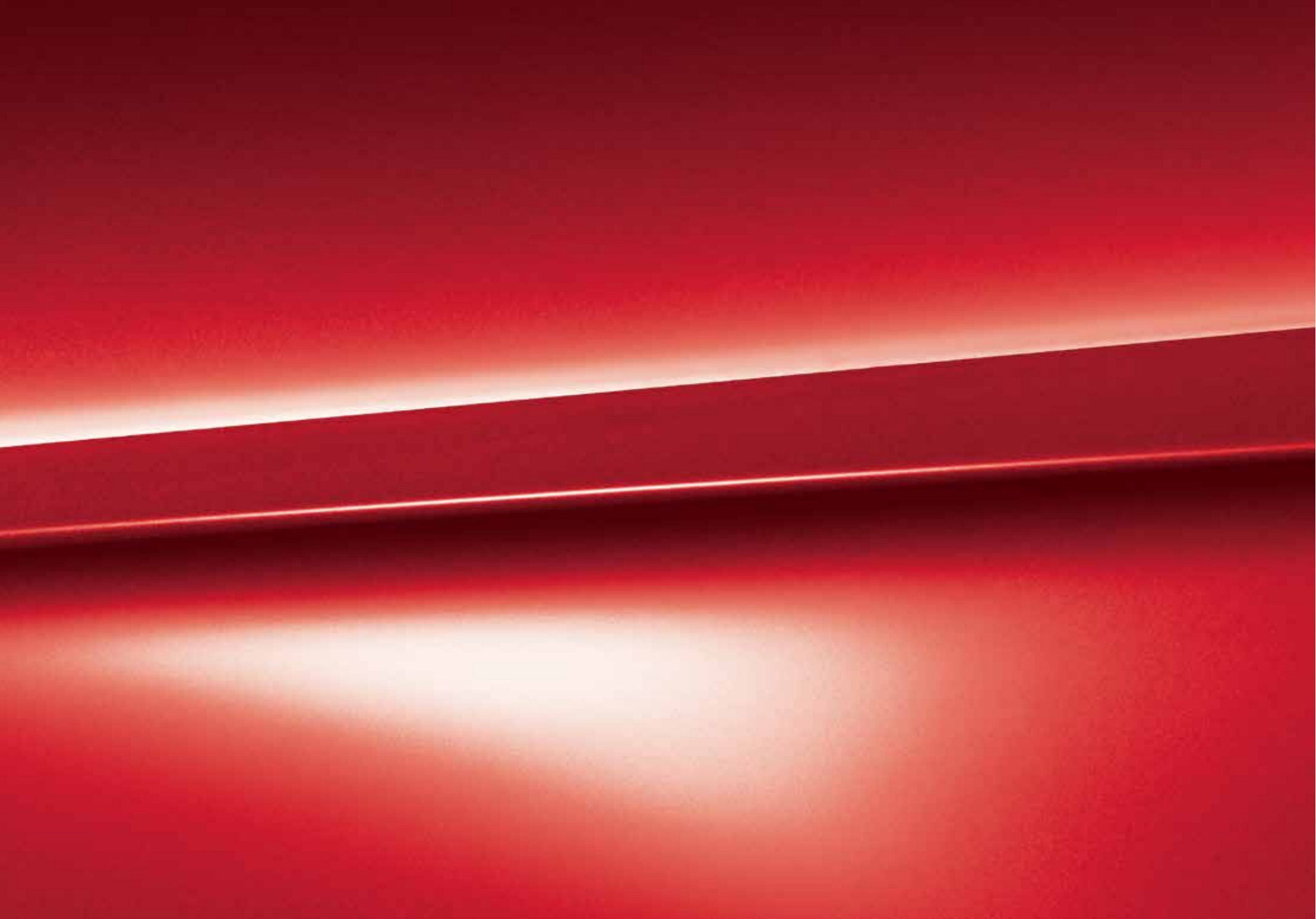

Paint

You can select the standard colours shown opposite – all of which are included in the cost of your RS 6 Avant or, for a different look, choose from a range of optional crystal effect or matt finishes.

Standard colours

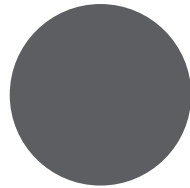

Nardo grey - T3

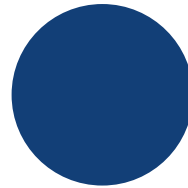

Sepang blue, pearl effect - E9

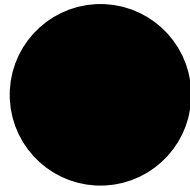

Mythos black, metallic - 0E

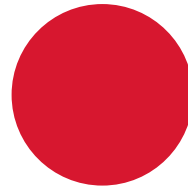

Misano red, pearl effect - N9



Glacier white, metallic - 2Y

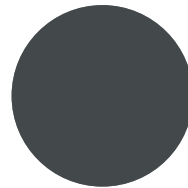

Daytona grey, pearl effect - 6Y

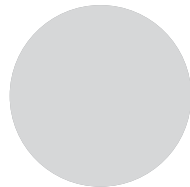

Floret silver, metallic - L5

Crystal effect



Prism silver, crystal effect - T0

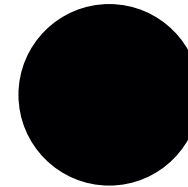

Panther black, crystal effect - H8

Matt colour

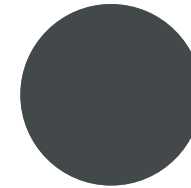

Daytona grey, matt - I6*

Options are subject to availability and may extend delivery.

*Extended lead time on matt paint. Please speak to your local Audi Centre.

All the colour swatches on this page are matched as accurately as possible to the actual paint colours used. However, due to print processes, Audi UK cannot guarantee that colours shown are 100% accurate.

Visit your local Audi Centre for a more accurate colour swatch.

RRP - Recommended Retail Price.

VAT is calculated at 20% but this may alter to reflect any change in the applicable VAT rate.

Crystal effect paint

Total RRP inc VAT
£250.00

Matt paint*

Total RRP inc VAT
£5,675.00

Paint

Audi exclusive

Everyone has a favourite colour. No matter what yours is, Audi exclusive provides a range of unique colours that have been designed to set your car apart. Choose from the swatches here, or specify any other paint colour in the Audi range. Please be aware that extended lead times apply to exclusive colours.*

Customised paint

If you have a particular colour in mind, we'll mix the exact metallic or pearl-effect shade you want.**

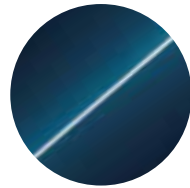

Palace blue, pearl effect

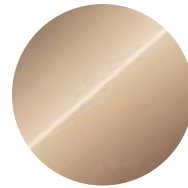

Sand beige, pearl effect

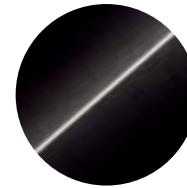

Saddle brown, pearl effect

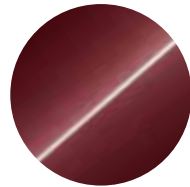

Classic red, pearl effect

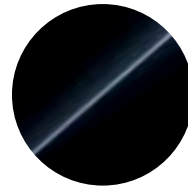

Mamba black, metallic

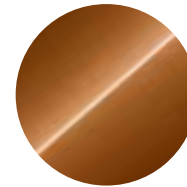

Ipanema brown, metallic



Any colour in the Audi range or 100 exclusive colours to choose from*

Audi exclusive*

Total RRP inc VAT
£1,500.00



Customised paint**

Customised**

Total RRP inc VAT
£2,000.00

*Audi exclusive paint is subject to factory approval. Visit your local Audi Centre for colour samples.

**Customised paint is subject to factory approval, and is available for metallic and pearl-effect water-based paints only. Three-colour process colours and two-tone schemes are not available.

All the colour swatches on this page are matched as accurately as possible to the actual paint colours used. However, due to print processes, Audi UK cannot guarantee that colours shown are 100% accurate.

Visit your local Audi Centre for a more accurate colour swatch.

RRP – Recommended Retail Price.

VAT is calculated at 20% but this may alter to reflect any change in the applicable VAT rate.

Upholstery

It's important to feel comfortable on the road. Just choose from our range of luxury upholstery materials and textures, including additional heating and colour options, for complete relaxation while you drive.





Upholstery

RS embossed front Super Sports seats

Choose your favourite upholstery from the swatches shown opposite to give your car's interior the look and feel you want.

You can also order Comfort seats as shown below.

Comfort seats – PS8

Includes memory function for driver and front passenger seat.

Comfort seats are not available in honeycomb quilted design and will remove RS embossing.





Options are subject to availability and may extend delivery.

- = Not available
- = Available
- S = Standard

*Only in combination with cloth headlining (6N1).

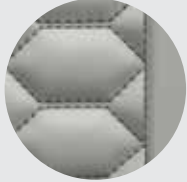
RRP – Recommended Retail Price.

VAT is calculated at 20% but this may alter to reflect any change in the applicable VAT rate.

		RS 6 Avant	Total RRP inc VAT
Valcona leather – honeycomb quilted design	 <p>Black with Rock grey stitching – UB/QI*</p>	S	No charge
	 <p>Lunar silver with Rock grey stitching – QO/SO*</p>		
	 <p>Black with Black stitching – QH/UO*</p>		
Leather/Alcantara – diamond stitched design	 <p>Black – QH/UO*</p>	•	No charge
Valcona leather	 <p>Black – QH/UO*</p>	•	No charge

Seats

Choose from a variety of different seat options so you can maintain the right driving comfort at all times.

Order Code		RS 6 Avant	Total RRP inc VAT
4D3	Seat ventilation for front seats. Three different intensities of cool air drawn through the seat for active ventilation of the seat-centre section and thigh support. To allow for the seat ventilation, the leather of the seat front is perforated. Only available in combination with Comfort seats (PS8)	●	£840.00
4D8	Massage and seat ventilation for front seats. Massage function with five different programs (wave, pulse, stretch, lumbar, shoulders) and four levels of intensity for massaging the muscles with the help of ten pneumatic cushions. Ventilation with three different intensities of cool air drawn through the seat for active ventilation of the seat-centre section and thigh support. To allow for the seat ventilation, the leather of the seat front is perforated. Only available in combination with Comfort seats (PS8)	●	£1,600.00
4A4	Heated front and outer rear seats. Works in the same way as front seat heating, enabling you to regulate the rear seats separately	●	£340.00

Interior equipment

Order Code		RS 6 Avant	Total RRP inc VAT
6NA	Audi exclusive headlining in black Alcantara with black stitching – headlining, upper pillar trim, parcel shelf and sunvisors in black Alcantara with black stitching. Only in combination with interior codes UB/QH/QO	●	£2,000.00
1XT	3-spoke leather multi-function Sports steering wheel – heated. With gear shift paddles in aluminium-look, contrast stitching and RS emblem	●	£200.00

Options are subject to availability and may extend delivery.

- = Not available
- = Available
- S = Standard

RRP – Recommended Retail Price.

VAT is calculated at 20% but this may alter to reflect any change in the applicable VAT rate.

Colour and trim guide

Interior trim colours

RS embossed front Super Sports seats

Use this guide to help you choose the right interior for your Audi RS 6 Avant. It shows the carpet, dashboard and headlining colours that have been matched to your chosen upholstery.

*In combination with interior colour codes QI/SO/UO, please add silver headlining (6N).

Order code	Upholstery	Carpet	Dashboard	Headlining	Valcona leather (N5M)	Leather/Alcantara (N7S)
UB/QI*	Black with Rock grey stitching	Black	Black	Black/Silver	●	—
QO/SO*	Lunar Silver with Rock grey stitching	Black	Black	Black/Silver	●	—
QH/UO*	Black	Black	Black	Black/Silver	●	●

Comfort seats

Order code	Upholstery	Carpet	Dashboard	Headlining	Valcona leather (N5D)
QH/UO*	Black	Black	Black	Black/Silver	●

Options are subject to availability and may extend delivery.

- = Not available
- = Available
- S = Standard



Inlays

Attention to detail can make a big impact. From contemporary black Piano finish to matt-brushed aluminium, our selection of inlays make the perfect finishing touch to your car's interior.





Inlays

Inlays are the all-important finishing touch that add flair and interest to your car's interior. Choose from the range of sleek inlays shown opposite.

Order Code		RS 6 Avant	Total RRP inc VAT
5MB	Carbon. Covers centre console, door trims and the continuous inlay seam, with aluminium-look edging	S	No charge
5TG	Matt-brushed aluminium. Covers centre console, door trims and the continuous inlay seam	●	No charge
5TL	Piano finish, black. Covers centre console, door trims and the continuous inlay seam, with aluminium-look edging	●	No charge
5TB	Aluminium, beaufort black. Covers centre console, door trims and the continuous inlay seam, with aluminium-look edging	●	£1,450.00

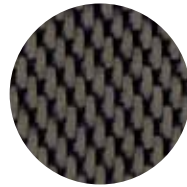

Carbon – **5MB**



Matt-brushed aluminium – **5TG**

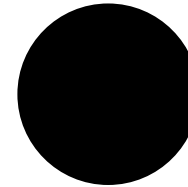

Piano finish, black – **5TL**

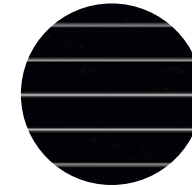

Aluminium, beaufort black – **5TB**

Options are subject to availability and may extend delivery.

- = Not available
- = Available
- S = Standard

RRP – Recommended Retail Price.

VAT is calculated at 20% but this may alter to reflect any change in the applicable VAT rate.

Inlays

Audi exclusive

Audi exclusive has sourced a varied range of materials from which to craft these elements.

Order Code		RS 6 Avant	Total RRP inc VAT
YTA S3G	Audi exclusive inlays. Cannot be combined with any of the inlays on page 42	●	£1,395.00



Fine grain ash, nougat



Oak, sepia



Fine grain myrtle, nutmeg



Modrone wood, gold



Vavona wood, bronze



Tamo ash, natural dark brown

Options are subject to availability and may extend delivery.

- = Not available
- = Available
- S = Standard

RRP - Recommended Retail Price.

VAT is calculated at 20% but this may alter to reflect any change in the applicable VAT rate.

Options

Every driver has different needs, which is why we have created some useful options to further enhance your car. For extra comfort, support, style or function, you can choose from a variety of additional features, tailoring everything from your infotainment and audio equipment to your wheels and exterior styling.





Wheels and tyres

Choose a set of specially-selected alloy wheels to subtly enhance the way your car looks and drives.

Order Code		RS 6 Avant	Total RRP inc VAT
PQ7	21" x 9.5J '5-twin-spoke' design polished alloy wheels with 285/30 R21 tyres	●	£1,900.00
PQR	21" x 9.5J '5-twin-spoke' design titanium-look alloy wheels with 285/30 R21 tyres	●	£2,000.00
PQ4	21" x 9.5J '5-twin-spoke' design black-gloss alloy wheels with 285/30 R21 tyres	●	£2,000.00



21" x 9.5J '5-twin-spoke' design polished alloy wheels – PQ7



21" x 9.5J '5-twin-spoke' design titanium-look alloy wheels – PQR



21" x 9.5J '5-twin-spoke' design black-gloss alloy wheels – PQ4

Options are subject to availability and may extend delivery.

- = Not available
- = Available
- S = Standard

RRP – Recommended Retail Price.

VAT is calculated at 20% but this may alter to reflect any change in the applicable VAT rate.

Packages

Some items work well together, which is why we've created these special packages. They provide increased convenience and value by combining several of our most popular options. The driver assistance systems featured on these pages work only within system limits. They assist the driver with driving tasks. However, the driver remains responsible for driving the vehicle and is required to be attentive.

Options are subject to availability and may extend delivery.

- = Not available
- = Available
- S = Standard

*Screens must be ordered by your local Audi Centre via Audi Genuine Accessories.

RRP – Recommended Retail Price.

VAT is calculated at 20% but this may alter to reflect any change in the applicable VAT rate.

Order Code		RS 6 Avant	Total RRP inc VAT
WC9	Parking Pack. Offers state-of-the-art parking systems for easy parking - Park assist helps identify suitable parking spaces before enabling an effortless manoeuvre into them – you simply accelerate and brake while the vehicle automatically steers - Additionally, a rear camera provides imagery with guidelines to ensure easy reverse parking	•	£810.00
WF5	Parking Pack Advanced. Features all the content of the Parking Pack and adds the innovative top view image for the ultimate luxury in parking systems - In addition to the benefits of the Parking Pack, safety and assurance is further enhanced through the use of additional cameras in the front grille, handle of the bootlid and the housing of the two exterior mirrors, which support entry and exit from tight spaces. The driver can also choose between different image representations in the MMI display, including a live “birds eye view” image for parking	•	£1,310.00
WTG	Entertainment Pack: Offers the perfect systems to keep all your passengers happy, however long your journey - TV tuner for reception of free-to-air TV channels. Reception dependent on local network availability. Picture display only possible on MMI screen when your RS 6 is stationary, audio available at all times - Rear seat entertainment system includes two separate portable entertainment units, each with a 9” screen* mounted to the back of the front seats. Playback available from a variety of sources including Bluetooth, CD/DVD, SD Card, USB and AV. Carry case, remote control, table-top stand, 2.5 hour battery for external playtime, charging lead and headphones also included. Only in combination with Comfort seats (PS8)	•	£2,020.00

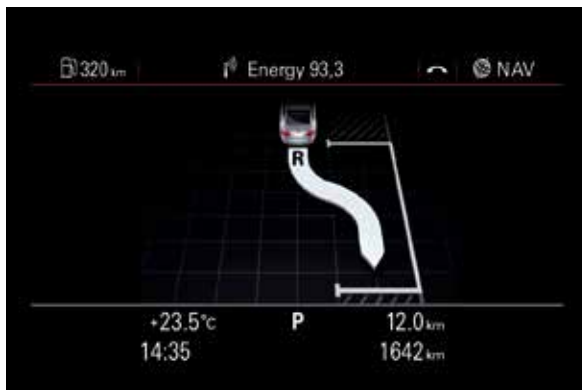

Park assist available within Parking Pack and Parking Pack Advanced

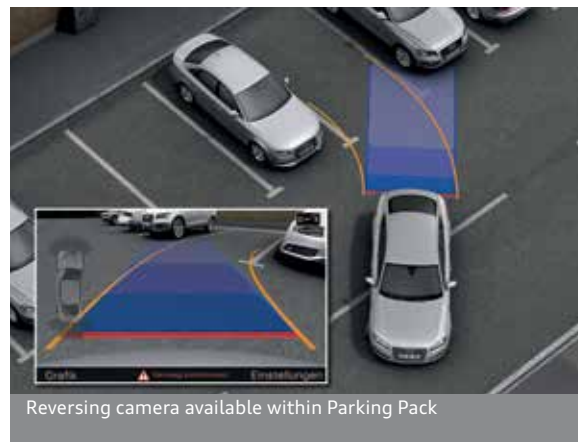

Reversing camera available within Parking Pack



Audi Entertainment Mobile available within Entertainment Pack

Packages

Some items work well together, which is why we've created these special packages. They provide increased convenience and value by combining several of our most popular options. The driver assistance systems featured on these pages work only within system limits. They assist the driver with driving tasks. However, the driver remains responsible for driving the vehicle and is required to be attentive.

Order Code		RS 6 Avant	Total RRP inc VAT
PA2	Dynamic Package. Includes a top speed restriction increase to 174mph*, RS sports suspension plus with Dynamic Ride Control (2MC), Dynamic steering (1N8). Please see page 49 for more information about the individual options. Please note this option forces the removal of tow bar bracket preparation (1D0)	●	£2,600.00
PA3	Dynamic Package Plus. Includes a top speed restriction increase to 189mph*, Ceramic brakes (PCS), RS Sports suspension plus with Dynamic Ride Control (2MC) and Dynamic steering (1N8). Please see page 49 for more information about the individual options. Please note that this option forces the removal of tow bar bracket preparation (1D0)	●	£11,500.00
PCN	<p>Assistance Pack. Includes the following items:</p> <p>Adaptive cruise control with Stop&Go which uses radar sensors to detect vehicles ahead. The distance between vehicles is maintained by braking or accelerating</p> <p>Pre-sense plus. Includes enhanced brake assist functions which can detect and warn of imminent collision threats as well as initiate maximum braking to help avoid or minimise collisions if possible.</p> <p>Audi side assist. Aids the driver when changing lane. Audi side assist monitors the area behind your car, using radar sensors located discreetly in the rear bumper, informing the driver with a visual warning signal in the door mirror if there is a vehicle in their blind spot or approaching quickly from behind</p> <p>Audi active lane assist. Helps the driver to stay in lane with gentle steering impulses for greater safety and convenience, particularly on motorways and country roads:</p> <ul style="list-style-type: none"> - Informs driver if car is drifting out of lane without activating the indicator (works at speeds above approximately 37mph) - Driver has the choice of two system settings in the MMI: <ol style="list-style-type: none"> 1) Steering point "early": continuously helps the driver to stay in lane with steering impulses that centre the vehicle in its lane 2) Steering point "late" alerts the driver that the vehicle is possibly crossing the lane markings at the same time as providing a corrective steering prompt - Additional warning via vibrating steering wheel when lane markings are crossed, if specified by driver - Additional indication in head-up display (if fitted) <p>In combination with Audi side assist there is also a noticeable steering intervention before changing lane if a lane change is judged to be hazardous due to an approaching vehicle. This intervention only occurs when both systems are activated and are ready</p>	●	£2,100.00
WFL	<p>Convenience Pack. An option pack featuring numerous useful items to make your RS 6 Avant as practical and as functional as possible</p> <ul style="list-style-type: none"> - The luggage compartment comes with a reversible mat, a fixing set for the rail system which includes a telescopic pole and fastening strap for dividing up the luggage area. A through-load facility for long items is also provided which comes complete with a removable ski/snowboard bag - Passengers in the rear seats will be able to manually adjust blinds on the rear window and rear door windows 	●	£625.00

Options are subject to availability and may extend delivery.

- = Not available
- = Available
- S = Standard

*Where the law permits.

RRP – Recommended Retail Price.

VAT is calculated at 20% but this may alter to reflect any change in the applicable VAT rate.

Performance

We've developed a whole range of performance options to complement the capabilities of the RS 6 Avant – everything from an increased top speed to a high performance brake system.

Options are subject to availability and may extend delivery.

- = Not available
- = Available
- S = Standard

*Where the law permits.

RRP – Recommended Retail Price.

VAT is calculated at 20% but this may alter to reflect any change in the applicable VAT rate.

Order Code		RS 6 Avant	Total RRP inc VAT
2MC	RS Sports suspension plus with Dynamic Ride Control (DRC). Enhanced suspension set-up which consists of a special shock absorber system that counteracts pitch and body roll movement without using any electronic devices. With DRC, diagonally opposed shock absorbers on the car are linked together hydraulically. A central valve varies the shock absorber operating characteristic, for example when the steering wheel is turned and the car is cornering, so that movement around the longitudinal axis (roll) is significantly reduced. DRC uses the same principle to counteract body movement around the transverse axis (pitch) when the car is accelerated or braked. There is a choice of three settings; comfort, dynamic or auto. Please note that this option forces the removal of tow bar bracket preparation (1D0)	•	£1,000.00
1N8	Dynamic steering. Improves comfort and handling by dynamically regulating steering according to the driving situation. Allows steering feel to be adapted to road speed and the chosen Audi drive select mode. With this technology, driving is significantly more agile under everyday conditions, while directional stability and precision are increased at high speeds and in demanding driving situations. Also enhances active safety with corrective steering inputs if critical situations are detected	•	£1,210.00
6Y4	Top speed restriction increase to 174mph*	•	£1,450.00
0P6	Sports exhaust. Oval-shaped, high-gloss black dual-exhaust pipes which further enhance the engine sound	•	£1,000.00
PC5	Ceramic brakes. 20-inch high-performance brake system with carbon-fibre reinforced, ventilated and perforated ceramic brake discs. Brake calipers are painted in high-gloss anthracite with 'Audi ceramic' logo on front. Benefits include extremely high level of wear resistance and enhanced fading resistance due to a lower sensitivity to high thermal loads. Not available in combination with Red brake calipers (PC2)	•	£9,375.00
PC2	Red brake calipers. Painted in high-gloss red. Not available in combination with Ceramic brakes (PC5)	•	£430.00



Standard brake calipers painted in high-gloss black with RS logo



Ceramic brakes – front

Audio and communication

Stay in touch using our range of communication functions, and give each journey its own soundtrack with our advanced audio equipment.

Options are subject to availability and may extend delivery.

- = Not available
- = Available
- S = Standard

RRP – Recommended Retail Price.

VAT is calculated at 20% but this may alter to reflect any change in the applicable VAT rate.

Order Code		RS 6 Avant	Total RRP inc VAT
8RF	<p>Bang & Olufsen Advanced sound system.</p> <ul style="list-style-type: none"> - 15 speakers including subwoofer and centre speaker, each with their own amplifier channel for genuine 5.1 surround sound - 15-channel DSP full-digital amplifier with a total output of over 1,200 Watts, fully digitised with highly efficient 5-channel ICEPower amplifier for woofers and subwoofer - When switched on, two acoustic lenses extend from the dashboard for excellent sound rendition and perspective from all seats - Polished aluminium speaker covers - Acoustics specially tuned to the interior through the targeted use of tweeters, mid-range speakers and woofers - Speakers in encapsulated housings isolate music and telephone conversations within the vehicle for privacy – when making phone calls in hands-free mode, for instance - Automatic adjustment of volume to the driving situation 	•	£6,300.00
9ZC	<p>Audi Connect and Audi Phone Box. Audi Connect offers convenient 4G internet access in your car providing access to a number of innovative online services including: navigation using Google Earth™ images and Google Street View™, emails, entertainment, social media, text messages and information services such as weather forecasts and the latest world news. Please note in order to use the services supported by Audi Connect you require a mobile telephone with SIM access Profile or a separate SIM card. Please refer to the terms and conditions on page 62 for further details about Audi Connect.</p> <p>Audi Phone Box enables drivers to use their mobile phone in the car by placing it in the storage compartment provided in the centre console to create a 'wireless' connection to the vehicle aerial. Operated via the MMI control panel or the multi-function steering wheel. Can be charged via a USB port</p>	•	£750.00
6G2	<p>CD changer and DVD player in glove compartment – DVD/CD changer, for 6 DVDs or CDs, supports audio CDs, video DVDs, shock-resistant and easily accessible in the glove compartment</p>	•	£640.00



Bang & Olufsen Advanced sound system



Audi Phone Box

Audio and communication

Order Code	RS 6 Avant	Total RRP inc VAT
<p>Head-up display. An optical system of mirrors project driving-related information directly into the driver's field of vision. To prevent ghost images, a special windscreen with a wedge-shaped film is fitted. This film measures approximately 26 x 9cm in size, and the driver perceives the display to be 2 to 2.5m beyond the windscreen. The display has many benefits:</p> <ul style="list-style-type: none"> - Helps to increase safety, convenience and driving pleasure - Straightforward operation via MMI - Display is height-adjustable, adjusts to ambient brightness - High resolution of up to 480 x 240 pixels <p>KS1 - The following are displayed, however some are dependent on additional options being chosen:</p> <ul style="list-style-type: none"> - Road speed - Navigation instructions - Adaptive cruise control status, distance from vehicle ahead and set speed (optional) - Warning messages from night vision assistant (optional) - Infotainment lists - Audi active lane assist (optional) - Speed limit display (optional) 	●	£1,240.00

Options are subject to availability and may extend delivery.

- = Not available
- = Available
- S = Standard

RRP – Recommended Retail Price.

VAT is calculated at 20% but this may alter to reflect any change in the applicable VAT rate.



Head-up display

Exterior equipment

Make sure your car looks exactly as you want it to, by selecting some of our striking options.

Options are subject to availability and may extend delivery.

- = Not available
- = Available
- S = Standard

*Additional wiring is required for auxiliary equipment.

RRP – Recommended Retail Price.

VAT is calculated at 20% but this may alter to reflect any change in the applicable VAT rate.

Order Code		RS 6 Avant	Total RRP inc VAT
PQZ	Matt aluminium styling package including air intake duct with quattro logo. Side flaps and top edge of the rear diffuser insert in matt aluminium-look. Also includes matt aluminium-look air intake duct with the quattro logo in titanium grey	•	£865.00
PQA	Carbon styling package including air intake duct with quattro logo. Front lip spoiler, side flaps and the rear diffuser insert in carbon. Carbon air intake duct with the quattro logo in titanium grey. Also includes the radiator grille frame, radiator grille and window capping strips in high-gloss black with roof rails in matt black. Please note this option forces the removal of tow bar bracket preparation (1D0)	•	£4,450.00
PA7 6FJ	Gloss black styling package including air intake duct with quattro logo. Front lip spoiler, radiator grille frame, exterior mirror housings and side window capping strips in high-gloss black. Also includes high-gloss black air intake duct with quattro logo in titanium grey and black roof rails. Not available in combination with Panther black, crystal effect paint (H8) or Mythos black, metallic paint (0E)	•	£980.00
3FU	Panoramic glass sunroof. Comprises two sections, where the front glass section can be tilted or slid open and closed again electrically. Includes electrically operated sun blind for the front and rear passengers. Can also be closed from the outside via the central locking	•	£1,250.00
1D4	Tow bar. Ball head and ball joint coupling made from forged steel. Mechanically swivelling ball head, operated via Bowden cable, with indicator light on Bowden cable and display in instrument cluster to monitor secure attachment of trailer towing hitch; includes trailer stabilisation system via the Electronic Stability Control (ESC). Includes single European 13-pin electrics socket and may require a 13- to 7-pin adaptor. Please consult your Audi Centre for details.* Not available in combination with Carbon optic package (PQA), Sports suspension with variable damping (2MC), Dynamic Package (PA2) or Dynamic Package Plus (PA3)	•	£825.00
NM5	Engine cover with carbon accents	•	£540.00
6FQ	Exterior mirror housings in carbon	•	£1,500.00
VW4	Privacy glass. Dark-tinted rear and rear-side windows (from B-pillar backwards)	•	£390.00
GZ2	Power door closure. Automatically pulls doors closed that are not completely engaged into lock	•	£620.00
ZZ0	Removal of model and technology designation	•	No charge



Safety and security

Order Code		RS 6 Avant	Total RRP inc VAT
7W1	Pre-sense basic. Audi Pre-sense is a comprehensive technical package for identifying dangers well in advance and intervening appropriately. Pre-sense basic networks the different vehicle systems, enabling driving situations to be categorised and, where necessary, actions to be taken to protect the driver and passengers. These include: belt tightening, activating the hazard warning system, closing the windows and the sunroof (if fitted)	●	£260.00
QR9	Speed limit display – the prevailing speed limit can be read on the Driver's Information System (DIS). Should the camera fail to see a sign properly, the speed limit from the data for the navigation system will be shown instead. The advantages: - Display of the speed limits currently registered, which can be called up in the Driver's Information System at any time - Display can be called up in every instrument cluster view and in the Head-up display (if fitted) - Camera-based system is also capable of detecting temporary speed restrictions in roadworks and on digital displays (e.g. over motorways) within the system limits - Display of national speed limits for Western European countries Only available in combination with Assistance pack (PCN)	●	£250.00
9R1	Night vision assistant. Assists the driver when driving at night by displaying a thermal image of the surroundings. People and large wild animals are highlighted in yellow in the colour display of the Driver's Information System. If the system determines from their position that there is a potential risk, the marking changes to red, a warning triangle appears and a warning tone is emitted. Warning can also be shown in the Head-up display (if fitted). The highlighted person is also illuminated with 3 successive brief flashes of the headlight. System operation maybe restricted in too much ambient light, high humidity and high night temperatures (over 28°C)	●	£1,750.00
PG3	Advanced key. Access and authorisation system which automatically exchanges data between key and vehicle, allowing the driver to keep the key in their pocket or bag at all times. To unlock and open, simply lift the exterior door handle. To lock, press the button on the handle. Pressing the start/stop button integrated in the centre console starts and stops the engine. Only in combination with Carbon styling package (PQA)	●	£750.00
PGB	Audi hands-free boot opening system with Advanced key. Access and authorisation system that works through automatic data exchange between key and vehicle, allowing the driver to keep their key in their pocket or bag at all times. To unlock and open, simply lift the exterior door handle. The door is locked by pressing the button on the handle. Pressing the start/stop button integrated in the centre console starts and stops the engine. Also allows the tailgate to be opened automatically by a simple kicking movement underneath the rear bumper. Not available in combination with Carbon styling package (PQA)	●	£750.00
4X4	Rear side airbags. For the outer rear seats, incorporated into the seat backrests; supplements the side impact protection in the doors and the standard airbag systems	●	£375.00

Options are subject to availability and may extend delivery.

- = Not available
● = Available
S = Standard

RRP – Recommended Retail Price.

VAT is calculated at 20% but this may alter to reflect any change in the applicable VAT rate.



Looking after your Audi

When you've chosen your ideal model, it's reassuring to know that it will remain in safe hands. That's why we've created products to protect your Audi, from extended warranties to Audi Complete – our comprehensive service and maintenance package. And there's also a range of Audi accessories and merchandise to choose from, enabling you to further enhance and safeguard your car.





Audi Complete

If you drive under 10,000 miles per annum your vehicle will be placed on a Fixed Inspection Service schedule. If your mileage tends to exceed 10,000 miles per annum it will be placed on the Flexible Service schedule.

Warranty

All new Audi models now come with a choice of three, four or five-year warranty.* What's more, if you decide to sell your Audi before the warranty expires, it will be fully transferred to the new owner. So, whichever length of warranty you choose, you can forget about unexpected repair bills and enjoy several years of carefree driving.

Options are subject to availability and may extend delivery.

- = Not available
• = Available
S = Standard

*Three year warranty consists of a two-year unlimited mileage warranty and a third year warranty with a 60,000-mile limitation. Four-year warranty consists of a two-year unlimited mileage warranty and two further years' coverage with a 75,000-mile limitation. Five-year warranty consists of a two-year unlimited mileage warranty and three further years' coverage with a 90,000-mile limitation.

**Only available before registration of your Audi RS 6. Please speak to your Audi Centre for full details.

RRP - Recommended Retail Price.

VAT is calculated at 20% but this may alter to reflect any change in the applicable VAT rate.

Audi Complete is our fixed-cost maintenance plan, which helps you keep your Audi in top condition and stay in control of your finances. For a simple monthly payment, you could cover your car's servicing, maintenance and, if you want, its tyres too.

So not only will you ensure your car runs smoothly, you'll also protect its future resale value. And because everything's covered by one competitive price, there's no need to go anywhere else.

Pricing is completely tailored to your vehicle and takes into consideration the options you have on your vehicle and your likely annual mileage and resultant service schedule. Please speak to your Audi Centre for a personalised quote for Audi Complete.

Order Code		RS 6 Avant	Total RRP inc VAT
-	Audi Warranty , covering you for unlimited mileage in the first two years of ownership, and up to 60,000 miles in the third year. Transferable between owners**	S	No charge
EA6	Audi Warranty , covering you for up to 4 years or 75,000 miles, whichever comes soonest. Cover includes a two-year unlimited-mileage warranty, and up to 75,000 miles in the third and fourth years. Transferable between owners**	•	£560.00
EA9	Audi Warranty , covering you for up to 5 years or 90,000 miles, whichever comes soonest. Cover includes a two-year unlimited-mileage warranty, and up to 90,000 miles in the third, fourth and fifth years. Transferable between owners**	•	£1,335.00



Merchandise

From the enthusiasts' motorsport collection to the sophisticated Audi collection, there's a wide variety of adults' and children's clothing, lifestyle accessories and collectables, all of which bear the Audi name.

Please speak to a member of our team at your local Audi Centre to see the full Audi collection and to place an order. A selection of Audi merchandise is also available to buy from audi.co.uk/merchandise



Image shown is the Audi kids' car legends, item number 320.13.004.00

The Audi Difference

The experts in Vorsprung durch Technik

Our Audi Approved Master Technicians have undergone an impressive 100,000 hours of training over a 10-year programme to ensure they have the latest technical expertise for maintaining and servicing your Audi. All our Service Advisors undergo a specialist induction and training to ensure they are Audi professionals and able to talk to you about any issues you may have with your Audi vehicle.

Servicing tailored to your needs

Regular servicing is key to safeguarding your Audi's performance and a full Audi service history could help you enhance the future re-sale value. To make servicing easy, the Audi Service Schedules have been designed to work with your individual driving style and vehicle.

We offer two different schedules: the Fixed Inspection Service and the Flexible Service schedule. The conventional fixed Inspection Service schedule has fixed intervals for the Oil-change Service and Inspection Service, which are determined by time and distance.

With the Flexible Service schedule, the Inspection Service intervals are also fixed but the Oil-change Service intervals are variable. Sensors take account of driving style and conditions to determine when the Oil-change Service is required and the driver is informed via the on-board service interval display.

The choice of Service Schedule will depend on journey type and mileage as well as individual driving style and conditions. The table to the right can be used for guidance but your Audi Centre will help you to determine the most suitable Service schedule for you based on your individual circumstances and preferences.

Fixed Inspection Service Schedule

	Vehicle usage:
Mileage	Less than 10,000 miles per annum Mainly city/town centre driving. Short journeys.
	Service Intervals:
Oil-change Service	Fixed to every 9,000+ miles/1 year
Inspection Service	Fixed to every 19,000+ miles/2 years

Flexible Service Schedule

	Vehicle usage:
Mileage	More than 10,000 miles per annum Motorway and main road driving. Mainly longer distance journeys. Constant speeds.
	Service Intervals:
Oil-change Service	Variable to a maximum of every 19,000+ miles/2 years
Inspection Service	Fixed to every 19,000+ miles/2 years

When a vehicle is frequently used in the following conditions, we recommend a Fixed Inspection Service Schedule, regardless of mileage:

Uneconomical driving styles, e.g. heavy acceleration and braking, constant use of high revs

High engine-loading conditions, e.g. frequent towing and hill climbs

*As indicated by the service interval display. Mileages are approximate as the Service Indicator system uses kilometres as its distance measurement.

Your convenience comes first

At Audi you can choose from a range of convenient services that suit your needs. Why not book a 'service while you wait' appointment* and enjoy our complimentary refreshments while your car is with us? Or, if you need to be mobile, take advantage of one of our courtesy cars which we can even deliver to you.* We guarantee we can service your Audi within 5 days without a courtesy car or within 10 days if you need transport. We will also ensure your car is returned to you with a full valet.

Audi Genuine Parts

You can rest assured that only Audi Genuine Parts will be used on your vehicle. What's more, Audi parts and labour come with a 2-year guarantee.**

No hidden costs

We believe strongly in transparency when it comes to our prices. For added peace of mind, we will give you a quotation over the phone for the work you have requested and email you the price confirmation. We'll consult you if any additional work on your car is needed when it is with us. We won't carry out any extra work without asking your permission first.

All part of the service

Whenever we see an Audi for a service, we connect it directly to our headquarters in Ingolstadt which enables us to check your car's software and make sure it's as up-to-date as possible. If the factory has released a software upgrade for your model, it can be applied immediately - improving anything from your car's efficiency to the precision of its parking system.

Audi Roadside Assistance

Your new car comes complete with 3 years' complimentary roadside assistance and recovery across the UK, provided by Automobile Association Insurance Services Limited. Also included is roadside assistance throughout Europe, managed by Automobile Association Insurance Services Limited.

For further information and terms and conditions please visit audi.co.uk

*Subject to availability.

**Excludes wear and tear.



RS 6 Avant technical data

Engine	4.0 TFSI quattro
Transmission	8-speed tiptronic
Cylinder	V8
Displacement, cubic cm (valves per cylinder)	3993
Max. power, ¹ PS at rpm	560/5700-6600
Max. torque, Nm at rpm	700/1750-5500
Top speed, mph*	155
0-62mph acceleration, seconds	3.9
CO ₂ emissions, ² g/km	223
Benefit in kind (BIK)%	37%
Fuel consumption, ² mpg (l/100km) Urban	21.1 (13.4)
Fuel consumption, ² mpg (l/100km) Extra Urban	38.2 (7.4)
Fuel consumption, ² mpg (l/100km) Combined	29.4 (9.6)
ABI insurance group 1-50**	50 E
Unladen weight, ³ kg	1950
Gross weight limit, kg	2580
Roof load limit/nose weight, kg	100/85
Max trailer load unbraked	750
Max load 12%	2100
Max load 8%	2100
Luggage compartment, seats upright, litres	565
Luggage compartment, seats folded, litres ⁴	1680
Fuel tank capacity approx, litres	75
Emission standard	EU6

*Electronically limited. Please see pages 48 and 49 for options to increase limit.

**Highest insurance group rating shown. Group may be lower dependent on trim level. Please visit www.thatcham.org/abigrouprating for details.

¹The given value was obtained in accordance with the specified measurement procedure (the respective current version of Directive 80/1269/EEC).

²Fuel consumption and CO₂ emissions figures are obtained under standardised test conditions (Directive 93/116/EEC) using a representative model. This allows direct comparison between different models from different manufacturers, but may not represent the actual fuel consumption achieved in 'real world' driving conditions. More information is available at www.dft.gov.uk/vca

³Vehicle's unladen weight without driver (calculated in accordance with the current version of Directive 92/21/EEC). The fitting of additional equipment may increase the vehicle's unladen weight and drag coefficient, whereupon the potential carrying capacity and top speed will be correspondingly reduced.

⁴Loaded up to roof with rear seat folded down.



RS 6 Avant dimensions

The technical drawings opposite show the exact dimensions of the RS 6 Avant, so you can check everything – from whether the car will fit in your garage to whether your luggage will fit in the boot.

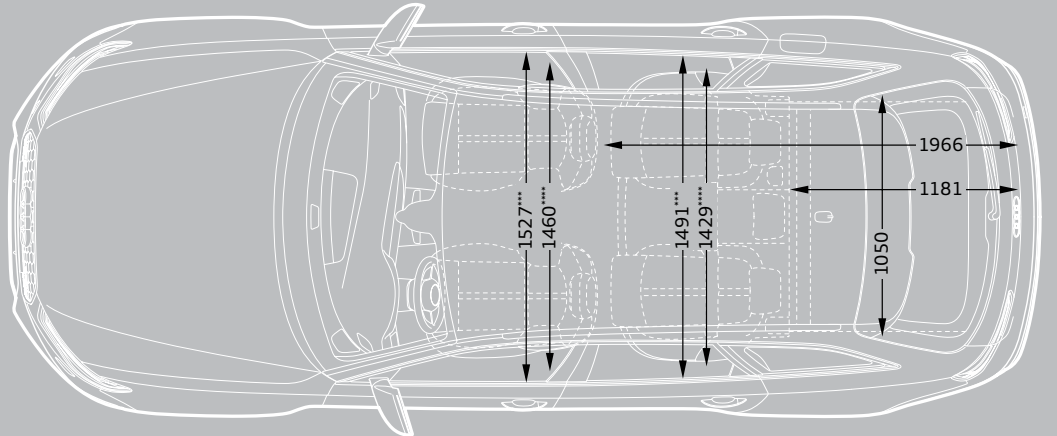
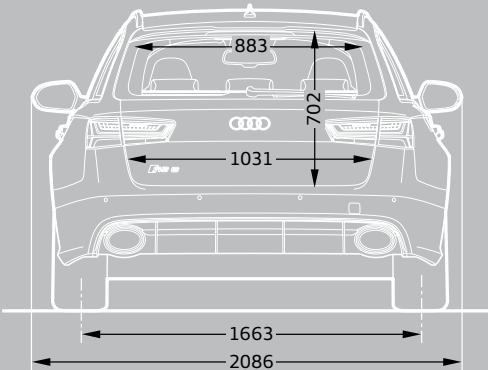
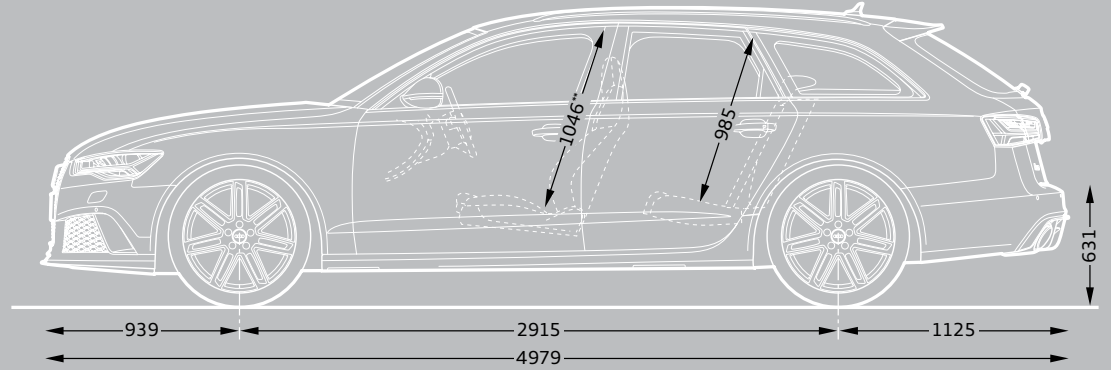
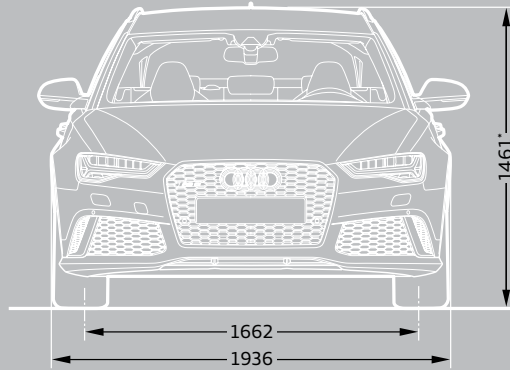

Dimensions in millimetres

*With roof aerial the height of the vehicle is 1,482mm

**Maximum headroom

***Shoulder width room

****Elbow width room

Dimensions were measured with vehicle at unladen weight, ground clearance measured with vehicle carrying its maximum load.

Luggage compartment volume in litres: 565/1,680 (measured by the VDA standard test method using 200 x 100 x 50mm blocks; second value: with rear seat folded down). Turning circle approx. 11.9m.

Pricing and Additional information

Welcome to Audi

By placing an order for your Audi, you're choosing to get behind the wheel of one of the most sophisticated cars on the road. And because we believe the service we offer should be just as advanced, we want to let you know exactly what you can expect from us, now and in the future.

We've agreed a set of standards with all our Centres which governs the way we do business with you. It outlines the kind of service we promise to deliver for every customer, right down to filling each new Audi we sell with half a tank of fuel.

So whether you're interested in the date your car will arrive in the UK or the way we'll dispose of non-biodegradable materials after we service your Audi, you can have total confidence in us.

Audi Promise

Audi Centres

We guarantee that all our Centres will be open as follows:

Sales: Monday to Friday 9am–6pm
Saturday 9am–5pm

Service: Monday to Friday 8am–6pm
Saturday 8.30am–1pm

Sunday opening is at local discretion.

New car delivery

Once we've confirmed a delivery date for your car, we'll keep you informed of progress. Subject to reasonable notice, we'll then deliver it to a place of your choice, whether that's your home or work. In the unlikely event of a delay, we'll provide a courtesy car to minimise inconvenience and keep you mobile.

Environmental commitment

We promise to dispose of all non-biodegradable materials from your vehicle in a responsible manner.

Pricing

Prices and specifications given are correct at the time of printing. Always check details with your Audi Centre as Audi policies are continually developing. We reserve the right to change prices or specifications at any time.

All prices are subject to VAT, currently charged at 20%, but this may alter to reflect any change in the applicable VAT rate.

Delivery charges and number plates are not included in the vehicle price.

Delivery charge	£504.99
Number plate	£20.00
VAT	£105.01
Total	£630.00

Audi Customer Care

Every new Audi benefits from the comprehensive Audi Customer Care Package, which comprises:

- ▶ A 3-year Audi warranty, which covers you for unlimited mileage in the first 2 years of ownership, with a full mechanical and electrical warranty which covers you for up to 60,000 miles in the 3rd year
- ▶ A 3-year paint warranty
- ▶ A 12-year anti-corrosion warranty
- ▶ 3 years' UK roadside assistance and recovery

You also have the option when ordering your new car of choosing a 4-year or 5-year Audi warranty. Speak to a member of the sales team for more information.

Audi tax-free sales

If you are entitled to purchase a vehicle free of VAT, normally through military or diplomatic privilege, please contact your local Audi Centre for full details.

Should you have any difficulty obtaining the information you require, please call 01908 548 356.

Audi Financial Services

Audi Financial Services specialises in providing funding solutions for Audi drivers. Whether your Audi is for private or business use, there is a range of funding options to choose from.

Below is the full range of finance products, which comprises:

- ▶ Solutions – a Personal Contract Plan
- ▶ Hire purchase
- ▶ Lease purchase
- ▶ Finance lease
- ▶ Contract hire

With all products, you can choose a fixed-cost maintenance plan designed to help you budget accurately.

No matter which Audi model you choose, your local Audi Centre can provide you with a personalised quote designed to fit your budget and motoring needs.

Audi Financial Services is a trading name of Volkswagen Financial Services (UK) Limited. An offer of finance depends on certain conditions. Available to people over 18 in the UK only.

Audi Insurance

We want you to start enjoying your new car from day one and thanks to Audi complimentary five day insurance you can. To activate simply call 0330 303 6900, provide us with a few details, and we'll send a cover note to your Audi Centre. They will then tax your car and you can drive it away. Telephone lines are open Monday to Friday 8am – 8pm and Saturday 9am – 4pm. For details of our full range of Insurance products visit insurewithaudi.co.uk

CO2 data and information

CO2 emissions-based Vehicle Excise Duty

Vehicle Excise Duty (Road Fund Licence) is based upon the amount of Carbon Dioxide (CO2) a vehicle emits, measured in grams per kilometre (g/km).

First year VED rates apply to the first year of ownership. Annual VED rates apply thereafter. The DVLA has created thirteen categories:

Petrol and Diesel engines	First year	Annual rate (second year onwards)
A – up to 100g/km	£0.00	£0.00
B – 101 to 110g/km	£0.00	£20.00
C – 111 to 120g/km	£0.00	£30.00
D – 121 to 130g/km	£0.00	£110.00
E – 131 to 140g/km	£130.00	£130.00
F – 141 to 150g/km	£145.00	£145.00
G – 151 to 165g/km	£180.00	£180.00
H – 166 to 175g/km	£295.00	£205.00
I – 176 to 185g/km	£350.00	£225.00
J – 186 to 200g/km	£490.00	£265.00
K – 201 to 225g/km	£640.00	£290.00
L – 226 to 255g/km	£870.00	£490.00
M – over 255g/km	£1,100.00	£505.00

Vehicle Excise Duty (VED) rates correct at time of going to print, but these may alter to reflect any change in the applicable VED rate.

Audi Connect

An external data source is required to enable Audi Connect online services. One of two can be used:

1. A mobile telephone with Bluetooth SIM Access Profile – to check the compatibility of your mobile phone and whether it has SIM Access Profile compatibility, please visit www.audi.co.uk/phonecompatibility
2. A separate SIM card which can be inserted in the included SIM card reader. When a separate SIM card is used, hands-free phone calls are possible using the SIM card or by connecting a different mobile telephone via Bluetooth Hands Free Profile

Online services are only available for mobile phone contracts or SIM cards which include a data option with the use of LTE, if LTE usage is required. Online services will only be available within the coverage of the mobile phone network; there may be additional costs for the use of these services (charges and billing correspond to the personal mobile phone contract or SIM card contract). Due to high data volumes, a mobile phone contract including an unlimited or high usage data plan is strongly recommended. The content and scope of the online based services offered may vary.

The Audi Connect services are provided for at least one year from vehicle delivery. After 24 months from delivery of the vehicle, the term of the Audi Connect services will be extended free of charge once for 12 months.

Audi Connect enables access to the services of Google and Twitter. Permanent availability cannot be guaranteed as this is the responsibility of Google and Twitter.

Please note that the services received are also dependent on the capability of your mobile phone.

Google and the Google logo are registered trademarks of Google Inc.

The availability of services supported by Audi Connect varies from country to country.

Online Map updates

The map version delivered can be updated with the first 5 updates which are issued at intervals of 6 months. The current navigation data can be downloaded from the myAudi Platform at www.audi.com/myaudi and installed in the vehicle via SD card. In conjunction with Audi Connect, the update can be carried out online in the vehicle. In addition it is possible to have the new navigation data installed by an Audi partner at extra cost.





Audi UK

Customer Services
Selectapost 29
Sheffield
S97 3FG
0800 699888
audi.co.uk

Specifications and prices subject
to change without notice.

© Audi (UK)

Printed in the UK
Edition 2.1 06/15
2016 model year

Images are for illustrative purposes only.